

The Moduflex Valve System redefines flexibility for pneumatic users. Whether configured from basic components or ordered as a pre-assembled and tested valve manifold, Moduflex flexibility is unmatched in the market place.

Ports

- Size 1: Push-in connectors for 5/32, 1/4 inch, 4, 6mm OD tube
- Size 2: Push-in connectors for 1/4, 3/8, 1/2 inch, 6, 8, 10, 12 mm OD tube

Mounting

- S Series – Individual subbase
- T Series – Manifold mount with individual connectors
- V Series – Manifold mount with collective wiring or fieldbus

Fieldbus options

- DeviceNet, Profibus, CANopen, AS-i, Interbus-S

Solenoids

- 1.0 Watt
- 24 VDC
- Compatible with PNP or NPN outputs

Certification / approval

- IP65 rated
- CE, as marked



Operating information

Operating pressure:	Vacuum to 123 PSIG (Vacuum to 8.3 bar)
Operating temperature:	5°F to 140°F (-15°C to 60°C)
Fieldbus operating temperature:	32°F to 130°F (0°C to 55°C)

Material specifications

End plates (T and V series)	Plastic
Fasteners	Nickel plated steel
Spool	Aluminum and nitrile rubber or ceramic plate
Subbase or manifold	Plastic
Valve body	Plastic

Dual 3/2 valves replace all 3-position valves for a better performance

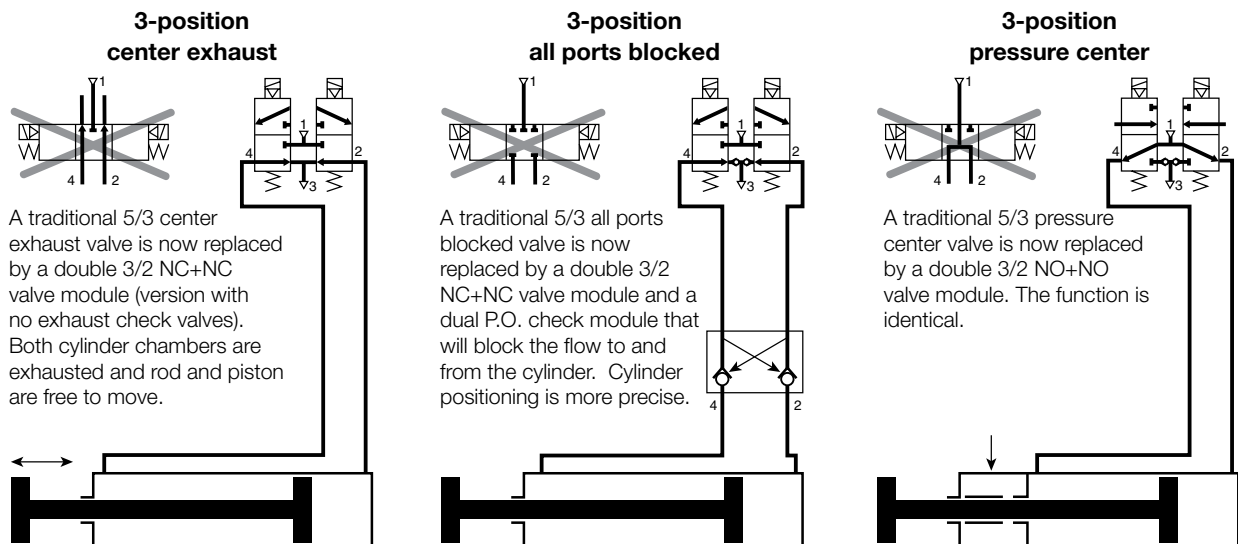

Most popular. For technical information see CD



Valvair II Series

DX ISOMAX Series

Fieldbus

Isys ISO Series













Isys Micro Series

Moduflex Series









D

Subbase & Manifold Valve Products











“S” Series Individual Subbase Valves Size 1 (Valve & Base without Pneumatic Connectors)

	Symbol	Type	Cv	Operator	Part number	
Valvair II Series			4-way, 2-position	0.32	Single solenoid	P2M1S4ES2C
					Single air pilot	P2M1S4PS
			4-way, 2-position	0.32	Double solenoid	P2M1S4EE2C
					Double air pilot	P2M1S4PP
DX ISOMAX Series			3-way, 2-position, dual valve, NC/NC w/ exhaust check	0.22	Double solenoid	P2M1SDEE2C
					Double air pilot	P2M1SDPP
			3-way, 2-position, dual valve, NO/NO w/ exhaust check	0.22	Double solenoid	P2M1SCEE2C
					Double air pilot	P2M1SCPP
			3-way, 2-position, dual valve, NC/NO w/ exhaust check	0.22	Double solenoid	P2M1SEEE2C
					Single solenoid	P2M1S3ES2C
		3-way, 2-position, dual valve, NC w/ exhaust check	0.22	Single air pilot	P2M1S3PS	
				Double solenoid	P2M1SGEE2C	
Fieldbus		3-way, 2-position, dual valve, NC/NC	0.22	Double solenoid	P2M1SGEE2C	







“S” Series Size 1 Accessories

	Description	Tube Size	Option	Part number
	Size 1 push to connect fitting	5/32"	Elbow	CMD04-1
			Straight	FMD04-1
	Size 1 push to connect fitting	1/4"	Elbow	CMD07-1B
			Straight	FMD07-1B
	Size 1 push to connect fitting	6mm	Elbow	CMD06-1
			Straight	FMD06-1
	Muffler for exhaust port			MMDVA1
	Plug			PMDYY1
	Double male union		Connecting peripheral modules	HMDXX1
	M8 female connector to flying lead - IP67 LED and surge protection		2m Cable	P8LS08L226C
			5m Cable	P8LS08L526C
			9m Cable	P8LS08L926C
	Field wireable connector		M8 Connector	P8CS0803J
			M12 Connector	P8CS1204J

“S” Series Individual Subbase Valves Size 2 (Valve & Base without Pneumatic Connectors)

	Symbol	Type	Cv	Operator	Part number
 Single Solenoid		4-way, 2-position	0.8	Single solenoid	P2M2S4ES2C
				Single air pilot	P2M2S4PS
 Single Air Pilot		4-way, 2-position	0.8	Double solenoid	P2M2S4EE2C
				Double air pilot	P2M2S4PP
 Double Solenoid		3-way, 2-position, dual valve, NC/NC w/ exhaust check	0.44	Double solenoid	P2M2SDEE2C
				Double air pilot	P2M2SDPP
 Double Air Pilot		3-way, 2-position, dual valve, NO/NO w/ exhaust check	0.44	Double solenoid	P2M2SCEE2C
				Double air pilot	P2M2SCPP
		3-way, 2-position, dual valve, NC/NO w/ exhaust check	0.44	Double solenoid	P2M2SEEE2C
		3-way, 2-position, NC w/ exhaust check	0.44	Single solenoid	P2M2S3ES2C
				Single air pilot	P2M2S3PS
		3-way, 2-position, dual valve, NC/NC	0.44	Double solenoid	P2M2SGEE2C

“S” Series Size 2 Accessories

	Description	Tube Size	Option	Part number
	Size 2 push to connect fitting	1/4" OD tube	Elbow	CMD07-2B
			Straight	FMD07-2B
	Size 2 push to connect fitting	3/8" OD tube	Elbow	CMD09-2B
			Straight	FMD09-2B
	Size 2 push to connect fitting	1/2" OD tube	Straight	FMD13-2B
	Size 2 push to connect fitting	6mm OD tube	Elbow	CMD06-2
			Straight	FMD06-2
	Size 2 push to connect fitting	8mm OD tube	Elbow	CMD08-2
			Straight	FMD08-2
	Size 2 push to connect fitting	10mm OD tube	Elbow	CMD10-2
			Straight	FMD10-2
	Size 2 push to connect fitting	12mm OD tube	Elbow	CMD12-2
			Straight	FMD12-2
		Muffler for exhaust port		
	Plug			PMDYY2
	Double male union		Connecting peripheral modules	HMDXX2
	M8 female connector to flying lead - IP67 LED and surge protection		2m Cable	P8LS08L226C
			5m Cable	P8LS08L526C
			9m Cable	P8LS08L926C
	Field wireable connector		M8 Connector	P8CS0803J
			M12 Connector	P8CS1204J

Valvair II Series

DX ISOMAX Series

Fieldbus

Isys ISO Series

Isys Micro Series

Moduflex Series

D

Subbase & Manifold Valve Products

“S” Series Individual Subbase Valve
(Complete with Pneumatic and Electrical Connectors)

Valvair II Series
 DX ISOMAX Series
 Fieldbus
 Isys ISO Series
 Isys Micro Series
 Moduflex Series
D Subbase & Manifold Valve Products

P2M 1 S 4ES 2C 00 A F4

Basic series	
Moduflex	P2M

Size	
Size 1	1
Size 2	2

Valve series	
Individual subbase	S

Valve type / function	
3-way / 2-position	
Single solenoid, NC spring return	3ES
Single air pilot, NC spring return	3PS
4-way / 2-position	
Single solenoid, spring return	4ES
Single air pilot, spring return	4PS
Double solenoid	4EE
Double air pilot	4PP
Dual 3-way, 2-position, spring return	
Solenoid, NC / NC + PO check (4/3 APB)	BEE*
Air pilot, NC / NC + PO check (4/3 APB)	BPP*
Solenoid, NO / NO (4/3 Pressure Ctr.)	CEE
Air pilot NO / NO (4/3 Pressure Ctr.)	CPP
Solenoid, NC / NC with exhaust check	
Air pilot, NC / NC with exhaust check	DPP
Solenoid, NO / NC with exhaust check	EEE
Solenoid, NC / NC without check (4/3 Exh. Ctr.)	GEE

Ports (all ports)	
C0*	10mm Elbow fitting
C2*	12mm Elbow fitting
C4	5/32" (4mm) Elbow fitting
C6	6mm Elbow fitting
C7	1/4" Elbow fitting
C8*	8mm Elbow fitting
C9*	3/8" Elbow fitting
F0*	10mm Straight fitting
F2*	12mm Straight fitting
F3*	1/2" Straight fitting
F4	5/32" (4mm) Straight fitting
F6	6mm Straight fitting
F7	1/4" Straight fitting
F8*	8mm Straight fitting
F9*	3/8" Straight fitting

* Only available with size 2 valves.

Fitting configuration	
A*	Straight fittings
B*	Elbow fittings
C*†	Straight fitting & muffler
D*†	Elbow fitting & muffler

* Ports 1 & 3 fittings sizes are same as ports 2 & 4 (see example at left.)
 † Fitting in port 1, muffler in port 3.

LED / Cable	
00	No cable, no LED, no surge suppression
V2	2 Meter cable with LED and surge suppression
V5	5 Meter cable with LED and surge suppression
V9	9 Meter cable with LED and surge suppression

Example for fitting configuration:
 Size 1

CF7 Ports 1 & 3
 1/4" straight fitting & muffler
 Ports 2 & 4
 1/4" straight fittings

Size 2

AC0 Ports 1 & 3
 10mm elbow fittings
 Ports 2 & 4
 10mm elbow fittings

Operator voltage	
24VDC	2C
Remote pilot - 5/32" (4mm) Tube	00

* Valve includes peripheral P. O. Check Valve and union fittings.







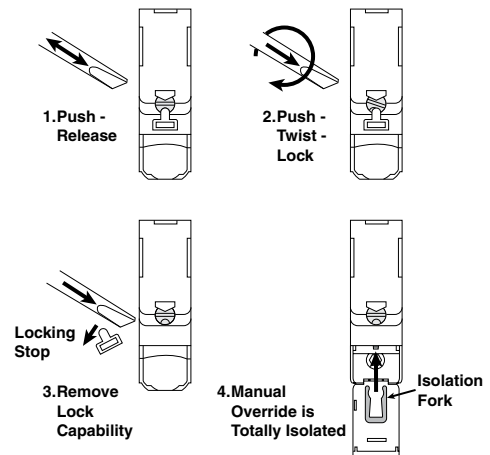







With only one universal solenoid pilot for all configurations

24VDC is now a global standard for all machines.
 The Moduflex 24VDC unique solenoid pilot is supplied with the multi-function manual override that can be adapted to all requirements, as explained by the drawings.













Multi-function adaptable manual override



"T" Series Manifold Valves with Individual Connectors Size 1

	Symbol	Type	Cv	Operator	Part number
 Single Solenoid		4-way, 2-position	0.32	Single solenoid	P2M1T4ES2C
				Single air pilot	P2M1T4PS
 Single Air Pilot		4-way, 2-position	0.32	Double solenoid	P2M1T4EE2C
				Double air pilot	P2M1T4PP
 Double Solenoid		4-way, 2-position, dual valve w/ exhaust check	0.18	Double solenoid	P2M1TJEE2C
				Double air pilot	P2M1TJPP
 Double Air Pilot		3-way, 2-position, dual valve, NC/NC w/ exhaust check	0.22	Double solenoid	P2M1TDEE2C
				Double air pilot	P2M1TDPP
 Double Solenoid		3-way, 2-position, dual valve, NO/NO w/ exhaust check	0.22	Double solenoid	P2M1TCEE2C
				Double air pilot	P2M1TCPP
 Double Air Pilot		3-way, 2-position, dual valve, NC/NO w/ exhaust check	0.22	Double solenoid	P2M1TEEE2C
				Single solenoid	P2M1T3ES2C
 Double Solenoid		3-way, 2-position, NC w/ exhaust check	0.22	Single air pilot	P2M1T3PS
				Double solenoid	P2M1TGEE2C

"T" Series Size 1 Accessories

	Description	Tube size	Option	Part number
 	Size 1 push to connect fitting	5/32" or 4mm	Elbow	CMD04-1
			Straight	FMD04-1
 	Size 1 push to connect fitting	1/4"	Elbow	CMD07-1B
			Straight	FMD07-1B
 	Size 1 push to connect fitting	6mm	Elbow	CMD06-1
			Straight	FMD06-1
	Muffler for exhaust port			MMDVA1
	Plug			PMDYY1
	Double male union		Connecting peripheral modules	HMDXX1
	M8 female connector to flying lead - IP67 LED and surge protection		2M cable	P8LS08L226C
			5M cable	P8LS08L526C
			9M cable	P8LS08L926C
	Field wireable connector		M8 connector	P8CS0803J
			M12 connector	P8CS1204J
	Torx screwdriver			P2M1K0TASD

Manifold Options

Module	Part number
Pneumatic end plate kit	P2M2HXT01*
Pneumatic end plate kit with torx screwdriver	P2M2HXT0T*
Intermediate supply module (Includes 4 configuration plates)	P2M2BXT0A*

* Use Fittings for Size 2 Modules Only









P2M2HXT01









P2M2BXT0A

“T” Series Manifold Valves with Individual Connectors Size 2

	Symbol	Type	Cv	Operator	Part number
Valvair II Series		4-way, 2-position	0.8	Single solenoid	P2M2T4ES2C
				Single air pilot	P2M2T4PS
		4-way, 2-position	0.8	Double solenoid	P2M2T4EE2C
				Double air pilot	P2M2T4PP
DX ISOMAX Series		3-way, 2-position, dual valve, NC/NC w/ exhaust check	0.44	Double solenoid	P2M2TDEE2C
				Double air pilot	P2M2TDPP
Fieldbus Series		3-way, 2-position, dual valve, NO/NO w/ exhaust check	0.44	Double solenoid	P2M2TCEE2C
				Double air pilot	P2M2TCPP
Fieldbus Series		3-way, 2-position, dual valve, NC/NO w/ exhaust check	0.44	Double solenoid	P2M2TEEE2C
				Single solenoid	P2M2T3ES2C
					Single air pilot
		3-way, 2-position, dual valve, NC/NC	0.44	Double solenoid	P2M2TGEE2C

“T” Series Size 2 Accessories

	Description	Tube size	Option	Part number
Ilys ISO Series	Size 2 push to connect fitting	1/4"	Elbow	CMD07-2B
			Straight	FMD07-2B
	Size 2 push to connect fitting	3/8"	Elbow	CMD09-2B
			Straight	FMD09-2B
Ilys Micro Series	Size 2 push to connect fitting	1/2"	Straight	FMD13-2B
			Size 2 push to connect fitting	6mm
	Straight	FMD06-2		
	Size 2 push to connect fitting	8mm	Elbow	CMD08-2
			Straight	FMD08-2
	Size 2 push to connect fitting	10mm	Elbow	CMD10-2
Straight			FMD10-2	
Moduflex Series	Size 2 Push to connect fitting	12mm	Elbow	CMD12-2
			Straight	FMD12-2
D Subbase & Manifold Valve Products		Muffler for exhaust port		MMDVA2
		Plug		PMDYY2
		Double male union		Connecting peripheral modules HMDXX2
		M8 female connector to flying lead - IP67 LED and surge protection	2M cable	P8LS08L226C
			5M cable	P8LS08L526C
			9M cable	P8LS08L926C
		Field wireable connector	M8 connector	P8CS0803J
			M12 connector	P8CS1204J
		Torx screwdriver		P2M1K0TASD

Manifold Options

Module	Part number
Pneumatic end plate kit	P2M2HXT01*
Pneumatic end plate kit with torx screwdriver	P2M2HXT0T*
Intermediate supply module (Includes 4 configuration plates)	P2M2BXT0A*

* Use Fittings for Size 2 Modules Only



"T" Series Valve Manifold with Individual Connectors
(Complete with Pneumatic and Electrical Connectors)

P2M 1 T 4ES 2C 00 0 F4

Basic series	
Valvetronic modules	P2M

Size	
Size 1	1
Size 2	2

Valve series	
Individual wire	T

Valve type / function	
<i>3-way / 2-position</i>	
Single solenoid, NC spring return	3ES
Single air pilot, NC spring return	3PS
<i>4-way / 2-position</i>	
Single solenoid, spring return	4ES
Single air pilot, spring return	4PS
Double solenoid	4EE
Double air pilot	4PP
<i>Dual 3-way, 2-position, spring return</i>	
Solenoid, NC / NC + PO check (4/3 APB)	BEE*
Air pilot, NC / NC + PO check (4/3 APB)	BPP*
Solenoid, NO / NO (4/3 Pressure Ctr.)	CEE
Air pilot NO / NO (4/3 Pressure Ctr.)	CPP
Solenoid, NC / NC with exhaust check	DEE
Air pilot, NC / NC with exhaust check	DPP
Solenoid, NO / NC with exhaust check	EEE
Solenoid, NC / NC without check (4/3 Exh. Ctr.)	GEE
<i>Dual 4-way, 2-position, Spring Return</i>	
Solenoid	JEE**
Air pilot	JPP**

* Valve includes peripheral P. O. check valve and union fittings.
 ** Size 1 only.

Ports 2 & 4	
C0*	10mm Elbow fitting
C2*	12mm Elbow fitting
C4	5/32" (4mm) Elbow fitting
C6	6mm Elbow fitting
C7	1/4" Elbow fitting
C8*	8mm Elbow fitting
C9*	3/8" Elbow fitting
F0*	10mm Straight fitting
F2*	12mm Straight fitting
F3*	1/2" Straight fitting
F4	5/32" (4mm) Straight fitting
F6	6mm Straight fitting
F7	1/4" Straight fitting
F8*	8mm Straight fitting
F9*	3/8" Straight fitting

* Only available with size 2 valves.

Ports 1 & 3	
0	None

Led / Cable	
00	No cable, no led, no surge suppression
V2	2 Meter cable with led and surge suppression
V5	5 Meter cable with led and surge suppression
V9	9 Meter cable with led and surge suppression

Operator Voltage	
2C	24VDC
00	Remote pilot - 5/32" (4mm) tube

Valvoir II Series
 DX ISOMAX Series
 Fieldbus
 Isys ISO Series
 Isys Micro Series
 Moduflex Series
D
 Subbase & Manifold Valve Products







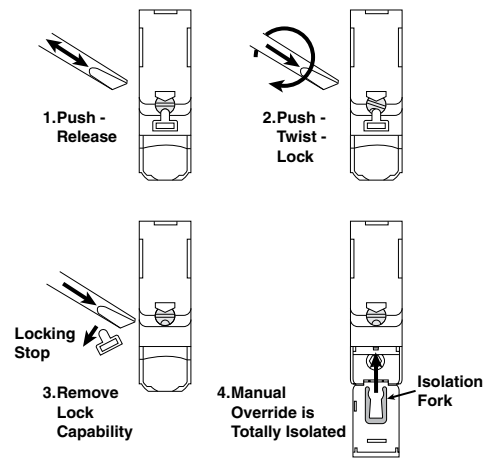

With only one universal solenoid pilot for all configurations

24VDC is now a global standard for all machines. The Moduflex 24VDC unique solenoid pilot is supplied with the multi-function manual override that can be adapted to all requirements, as explained by the drawings.









Multi-function adaptable manual override



“V” Series Manifold Valves with Collective Wiring Size 1

	Symbol	Type	Cv	Operator	Part number
 <p>Single Solenoid Double Solenoid</p>		4-way, 2-position	0.32	Single solenoid	P2M1V4ES2CV
		4-way, 2-position	0.32	Double solenoid	P2M1V4EE2CV
		4-way, 2-position, dual valve, w/ exhaust check	0.18		P2M1VJEE2CV
		3-way, 2-position, dual valve, NC/NC w/ exhaust check	0.22	Double solenoid	P2M1VDEE2CV
		3-way, 2-position, dual valve, NO/NO w/ exhaust check	0.22	Double solenoid	P2M1VCEE2CV
		3-way, 2-position, dual valve, NC/NO w/ exhaust check	0.22	Double solenoid	P2M1VEEE2CV
		3-way, 2-position, NC w/ exhaust check	0.22	Single solenoid	P2M1V3ES2CV
		3-way, 2-position, dual valve, NC/NC	0.22	Double solenoid	P2M1VGEE2CV

“V” Series Size 1 Accessories

	Description	Tube size	Option	Part number	
	Size 1 push to connect fitting	5/32"	Elbow	CMD04-1	
			Straight	FMD04-1	
	Size 1 push to connect fitting	1/4"	Elbow	CMD07-1B	
			Straight	FMD07-1B	
	Size 1 push to connect fitting	6mm	Elbow	CMD06-1	
			Straight	FMD06-1	
	Muffler for exhaust port			MMDVA1	
	Plug			PMDYY1	
	Double male union		Connecting peripheral modules	HMDXX1	
	Electrical 20-pin multi-connector cable with flying leads	IP65 rated	2M cable	P8LMH20M2A	
			5M cable	P8LMH20M5A	
			9M cable	P8LMH20M9A	
	Electrical 25-pin D-sub cable	IP20 rated	3M cable	P8LMH25M3A	
			9M cable	SCD259D	
			IP65 rated	3M cable	SCD253W
				9M cable	SCD259WE
	Field wireable connector for power supply	Female	M12 - A code	P8CS1205AA	
	Line termination resistor	Profibus DP	M12 type B	P8BPA00MB	
		Devicenet or Canopen	M12 type A	P8BPA00MA	
	AS-i M12 cable with jack for addressing		1M cable	P8LS12JACK	
	Torx screwdriver			P2M1K0TASD	

Electrical Connections

Description	Part number
20-pin, Multi-connector electrical head module	P2M2HEV0A
25-pin, D-sub, electrical head module	P2M2HEV0D

Fieldbus Connections

Description	Part number	
Profibus DP	P2M2HBVP21600	
DeviceNet	P2M2HBVD21600	
CANopen	P2M2HBVC21600	
Interbus S	P2M2HBVS11600	
AS-i	0 inputs and 8 solenoid outputs	P2M2HBVA10800
AS-i	8 (PNP) inputs on eight (M8) connectors and 8 solenoid outputs	P2M2HBVA10808A
AS-i	8 (PNP) inputs on four (M12) connectors and 8 solenoid outputs	P2M2HBVA10808B
AS-i Version 2.1 Protocol	AS-i 0 inputs and 6 solenoid outputs	P2M2HBVA20600
AS-i Version 2.1 Protocol	AS-i 8 (PNP) inputs on eight (M8) connectors and 6 solenoid outputs	P2M2HBVA20608A
AS-i Version 2.1 Protocol	AS-i 8 (PNP) inputs on four (M12) connectors and 6 solenoid outputs	P2M2HBVA20608B

Manifold Options

Module	Part number
Pneumatic end plate kit	P2M2HXT01*
Pneumatic end plate kit with torx screwdriver	P2M2HXT0T*
Intermediate supply module (Includes 4 configuration plates)	P2M2BXV0A*

* Use Fittings for Size 2 Modules Only



P2M2HXT01



P2M2BXV0A

Valvair II
Series

DX ISOMAX
Series

Fieldbus

Isys ISO
Series









Isys Micro
Series

Moduflex
Series













D

Subbase & Manifold
Valve Products

“V” Series Manifold Valves with Collective Wiring Size 2

	Symbol	Type	Cv	Operator	Part number
 <p>Single Solenoid</p> <p>Double Solenoid</p>		4-way, 2-position	0.8	Single solenoid	P2M2V4ES2CV
		4-way, 2-position	0.8	Double solenoid	P2M2V4EE2CV
		3-way, 2-position, dual valve, NC/NC w/ exhaust check	0.44	Double solenoid	P2M2VDEE2CV
		3-way, 2-position, dual valve, NO/NO w/ exhaust check	0.44	Double solenoid	P2M2VCEE2CV
		3-way, 2-position, dual valve, NC/NO w/ exhaust check	0.44	Double solenoid	P2M2VEEE2CV
		3-way, 2-position, NC w/ exhaust check	0.44	Single solenoid	P2M2V3ES2CV
		3-way, 2-position, dual valve, NC/NC	0.44	Double solenoid	P2M2VGEE2CV

“V” Series Size 2 Accessories

	Description	Tube size	Option	Part number
	Size 2 push to connect fitting	1/4" OD tube	Elbow	CMD07-2B
			Straight	FMD07-2B
	Size 2 push to connect fitting	3/8" OD tube	Elbow	CMD09-2B
			Straight	FMD09-2B
	Size 2 push to connect fitting	1/2" OD tube	Straight	FMD13-2B
				Size 2 push to connect fitting
Straight	FMD06-2			
	Size 2 push to connect fitting	8mm OD tube	Elbow	CMD08-2
			Straight	FMD08-2
	Size 2 push to connect fitting	10mm OD tube	Elbow	CMD10-2
			Straight	FMD10-2
	Size 2 push to connect fitting	12mm OD tube	Elbow	CMD12-2
			Straight	FMD12-2
	Muffler for exhaust port			MMDVA2
	Plug			PMDYY2
	Double Male Union		Connecting peripheral modules	HMDXX2
	Electrical 20-pin multi-connector cable with flying leads	IP65 rated	2M cable	P8LMH20M2A
			5M cable	P8LMH20M5A
			9M cable	P8LMH20M9A
	Electrical 25-pin D-sub cable	IP20 rated	3M cable	P8LMH25M3A
			9M cable	SCD259D
			3M cable	SCD253W
			9M cable	SCD259WE
	Torx screwdriver			P2M1K0TASD

Electrical Connections

Description	Part number
20-pin, Multi-connector electrical head module	P2M2HEV0A
25-pin, D-sub, electrical head module	P2M2HEV0D

Fieldbus Connections

Description	Part number	
Profibus DP	P2M2HBVP21600	
DeviceNet	P2M2HBVD21600	
CANopen	P2M2HBVC21600	
Interbus S	P2M2HBVS11600	
AS-i	0 inputs and 8 solenoid outputs	P2M2HBVA10800
AS-i	8 (PNP) inputs on eight (M8) connectors and 8 solenoid outputs	P2M2HBVA10808A
AS-i	8 (PNP) inputs on four (M12) connectors and 8 solenoid outputs	P2M2HBVA10808B
AS-i Version 2.1 Protocol AS-i	0 inputs and 6 solenoid outputs	P2M2HBVA20600
AS-i Version 2.1 Protocol AS-i	8 (PNP) inputs on eight (M8) connectors and 6 solenoid outputs	P2M2HBVA20608A
AS-i Version 2.1 Protocol AS-i	8 (PNP) inputs on four (M12) connectors and 6 solenoid outputs	P2M2HBVA20608B

Manifold Options

Module	Part number
Pneumatic end plate kit	P2M2HXT01*
Pneumatic end plate kit with torx screwdriver	P2M2HXT0T*
Intermediate supply module (Includes 4 configuration plates)	P2M2BXV0A*

* Use Fittings for Size 2 Modules Only



P2M2HXT01

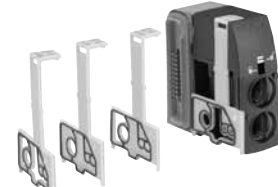

P2M2BXV0A

Valvair II
Series

DX ISOMAX
Series

Fieldbus

Isys ISO
Series

Isys Micro
Series

Moduflex
Series

D

Subbase & Manifold
Valve Products

“V” Series Valve Manifold with Collective Wiring
(Complete with Pneumatic Connectors)

Valvair II Series
 DX ISOMAX Series
 Fieldbus
 Isys ISO Series
 Isys Micro Series
 Moduflex Series
D
 Subbase & Manifold Valve Products

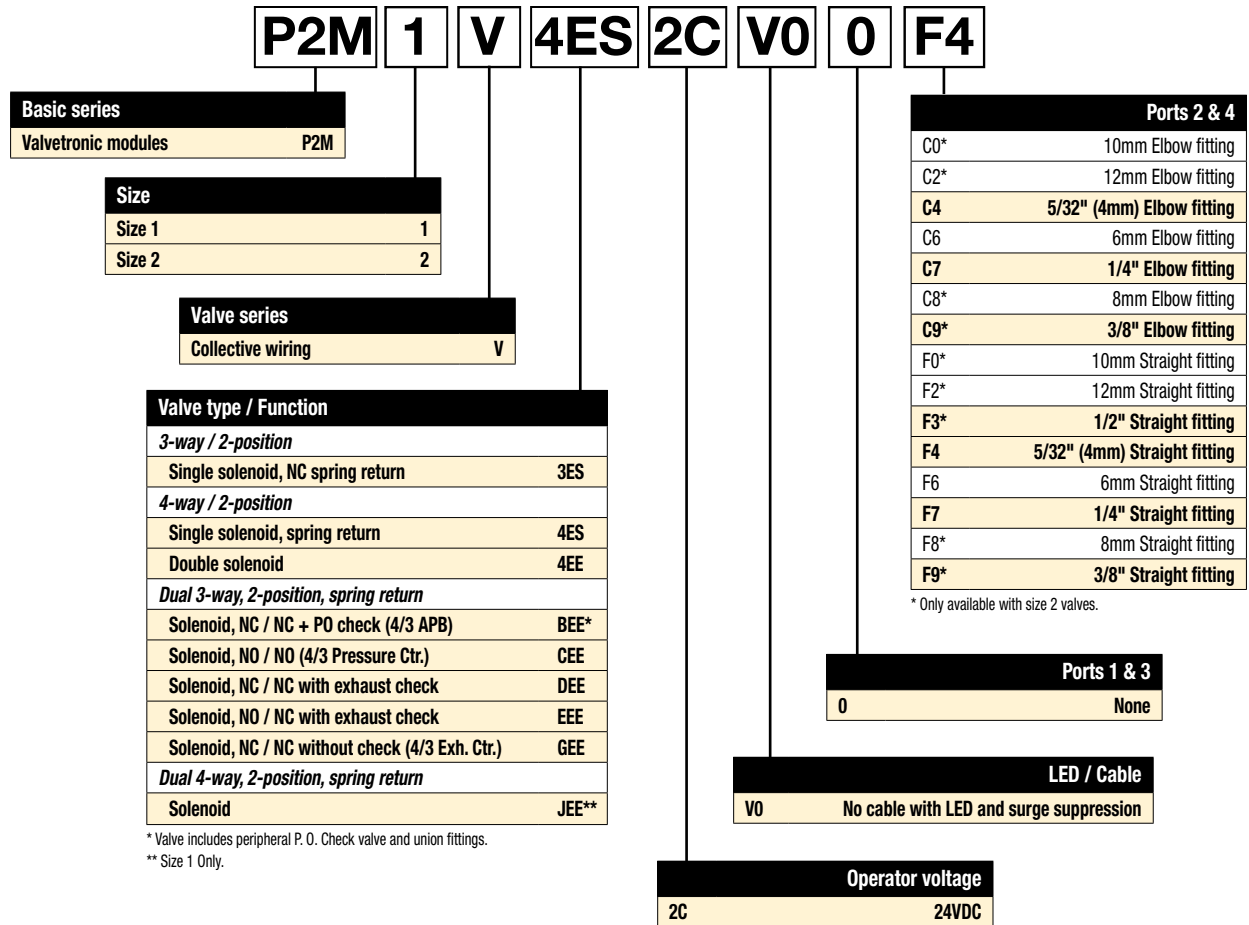







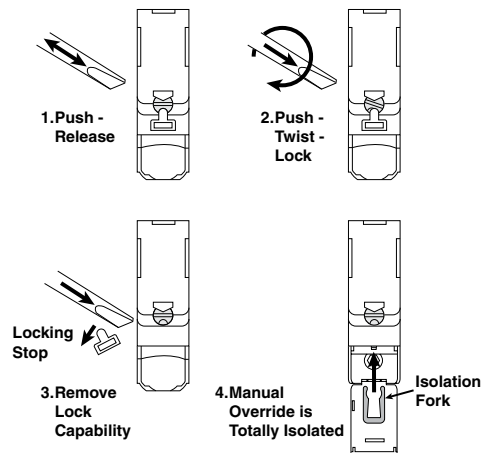



With only one universal solenoid pilot for all configurations

24VDC is now a global standard for all machines. The Moduflex 24VDC unique solenoid pilot is supplied with the multi-function manual override that can be adapted to all requirements, as explained by the drawings.

Multi-function adaptable manual override



Peripheral Modules Size 1

Accessories	Description	Option	Part number
	Pressure regulator without gauge	0 to 30 PSI	P2M1PXST
		0 to 60 PSI	P2M1PXSL
		0 to 120 PSI	P2M1PXSX
	Pressure regulator with gauge	0 to 30 PSI	P2M1PXSR
		0 to 60 PSI	P2M1PXSM
		0 to 120 PSI	P2M1PXSG
	Gauge	0 to 30 PSI	P2M1K0GT
		0 to 60 PSI	P2M1K0GL
		0 to 120 PSI	P2M1K0GN
	Dual P.O. Check valve		P2M1PXCA
	Dual flow control		P2M1PXFA
	Vacuum generator	See ordering information below	P2M1PXVA
	Size 1 push to connect fitting	5/32" or 4mm OD tube	Elbow CMD04-1 Straight FMD04-1
		1/4" OD tube	Elbow CMD07-1B Straight FMD07-1B
	Size 1 push to connect fitting	6mm OD tube	Elbow CMD06-1 Straight FMD06-1
			Connecting peripheral modules
	Double male union		HMDXX1
	Muffler for vacuum exhaust port		MMDVA1
	Plug		PMDYY1





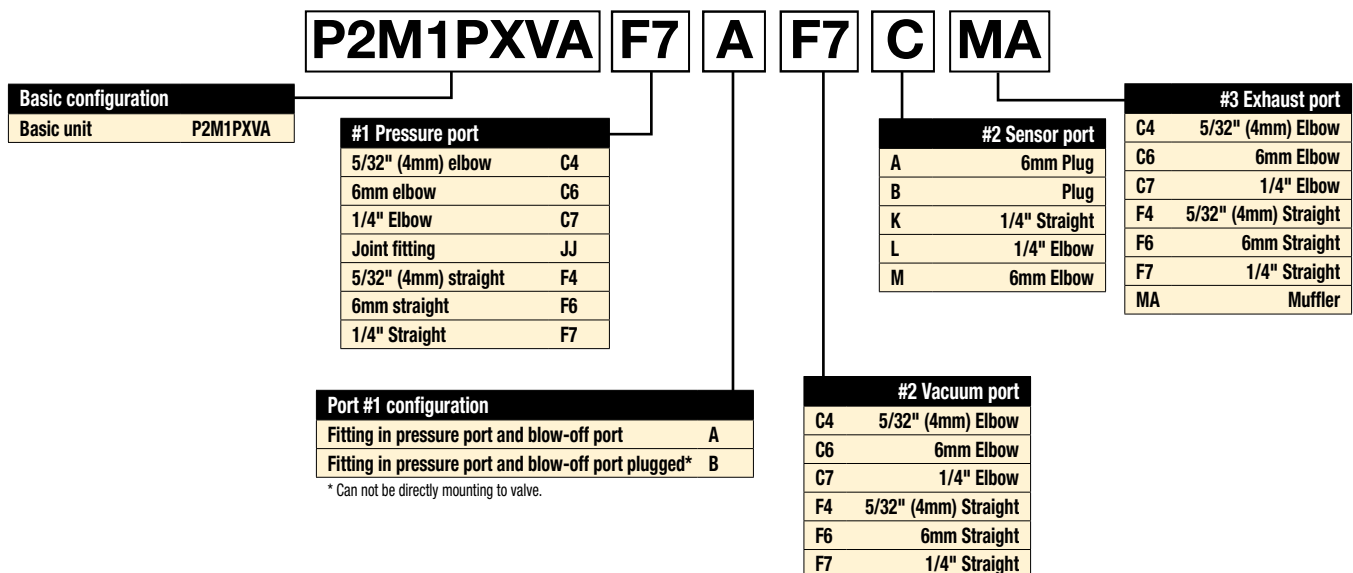









Valvair II Series
 DX ISOMAX Series
 Fieldbus
 Isys ISO Series
 Isys Micro Series
 Moduflex Series

Vacuum Generator Model Number Index



D
 Subbase & Manifold Valve Products

Peripheral Modules Size 2

	Accessories	Description	Option	Part number
Valvair II Series		Pressure regulator without gauge	0 to 30 PSI	P2M2PXST
			0 to 60 PSI	P2M2PXSL
			0 to 120 PSI	P2M2PXSN
Valvair II Series		Pressure regulator with gauge	0 to 30 PSI	P2M2PXSR
			0 to 60 PSI	P2M2PXSM
			0 to 120 PSI	P2M2PXSG
DX ISOMAX Series		Gauge	0 to 30 PSI	P2M1K0GT
			0 to 60 PSI	P2M1K0GL
			0 to 120 PSI	P2M1K0GN
Fieldbus		Dual P.O. check valve		P2M2PXCA
				Dual flow control
Isys ISO Series		Size 2 push to connect fitting	1/4" OD tube	Elbow CMD07-2B
			3/8" OD tube	Straight FMD07-2B
Isys Micro Series		Size 2 push to connect fitting	1/2" OD tube	Elbow CMD09-2B
			6mm OD tube	Straight FMD09-2B
Moduflex Series		Size 2 push to connect fitting	8mm OD tube	Elbow CMD13-2B
			10mm OD tube	Straight FMD13-2B
Moduflex Series		Size 2 push to connect fitting	12mm OD tube	Elbow CMD06-2
				Straight FMD06-2
Moduflex Series		Size 2 push to connect fitting	8mm OD tube	Elbow CMD08-2
			10mm OD tube	Straight FMD08-2
Moduflex Series		Size 2 push to connect fitting	12mm OD tube	Elbow CMD10-2
				Straight FMD10-2
Moduflex Series		Size 2 push to connect fitting	12mm OD tube	Elbow CMD12-2
				Straight FMD12-2
Moduflex Series		Muffler for exhaust port		MMDVA2
				Plug
Moduflex Series		Double Male Union	Connecting peripheral modules	HMDXX2

Valvair II Series
 DX ISOMAX Series
 Fieldbus
 Isys ISO Series
 Isys Micro Series
 Moduflex Series
D
 Subbase & Manifold Valve Products

“P” Series Peripheral Modules Model Number Index
(Complete with Pneumatic Connectors)

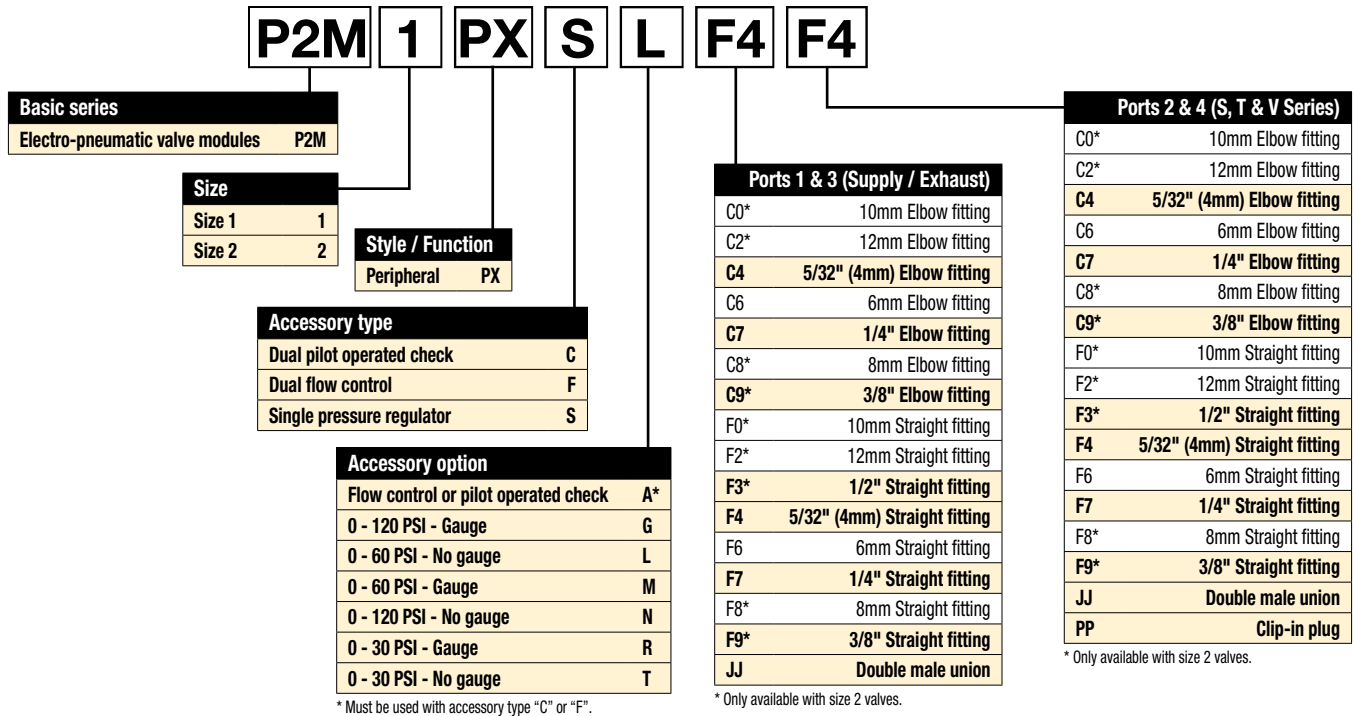

Intermediate Supply Module Model Number Index

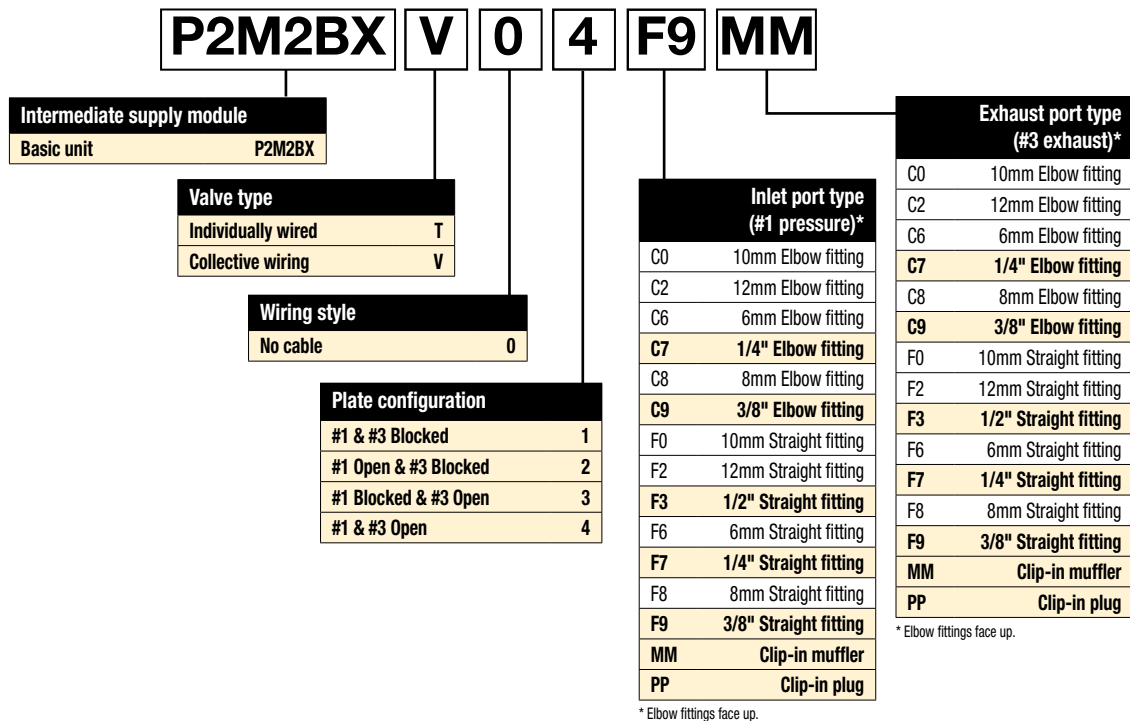

Moduflex Add-A-Fold Assembly Model Number Index
(Complete with Pneumatic and Electrical Connectors)

How To Order Plug-in Add-A-Fold Assemblies

1. List Add-A-Fold Assembly call out. This automatically includes the end plate kit assembly.
2. List valves and manifolds. List left to right, LOOKING AT THE CYLINDER PORTS on the manifold.

P2MA V 0 1 C9 C9 ##

Moduflex island assembly	
Add-A-Fold	P2MA*

*Includes pneumatic H & T end plate kit.

Style	
Individually wired	T
Collective wiring	V*

* Includes 20-pin multi-connector or 25-pin, D-sub electrical head module.

Wiring / Bus protocol	
No cable (20-pin multi-connector T series)	0
2 Meter cable (20-pin)	2
5 Meter cable (20-pin)	5
9 Meter cable (20-pin)	9
Bus	
No cable (25-pin, D-sub)	D
3 Meter cable (25-pin, D-sub)	F

* Order bus module as a separate line item.
 † Default to option "0" for T series.

Pilot source	
Internal supply / Internal exhaust	1
Internal supply / External exhaust	2
External supply / Internal exhaust	3
External supply / External exhaust	4

Number of stations [†]	
01 - 19*	V-Type
01 - 30	T-Type

* Max. number of addresses for V type is 19. Single solenoid valves equal one address. Double solenoid valves equal two addresses. Maximum address may depend upon choice of bus protocol.

† Intermediate modules are considered stations, but do not count against maximum number of addresses for manifold.

Exhaust port type (#3 Exhaust)*	
C0	10mm Elbow fitting
C2	12mm Elbow fitting
C6	6mm Elbow fitting
C7	1/4" Elbow fitting
C8	8mm Elbow fitting
C9	3/8" Elbow fitting
F0	10mm Straight fitting
F2	12mm Straight fitting
F3	1/2" Straight fitting
F6	6mm Straight fitting
F7	1/4" Straight fitting
F8	8mm Straight fitting
F9	3/8" Straight fitting
MM	Clip-in muffler
PP	Clip-in plug

* Elbow fittings face up.

Inlet port type (#1 pressure)*	
C0	10mm Elbow fitting
C2	12mm Elbow fitting
C6	6mm Elbow fitting
C7	1/4" Elbow fitting
C8	8mm Elbow fitting
C9	3/8" Elbow fitting
F0	10mm Straight fitting
F2	12mm Straight fitting
F3	1/2" Straight fitting
F6	6mm Straight fitting
F7	1/4" Straight fitting
F8	8mm Straight fitting
F9	3/8" Straight fitting
MM	Clip-in muffler
PP	Clip-in plug

* Elbow fittings face up.



"V" Series with 20-pin Connector



"V" Series with Field Bus Connection

Valvair II Series
 DX ISOMAX Series
 Fieldbus
 Isys ISO Series
 Isys Micro Series
 Moduflex Series
D
 Subbase & Manifold Valve Products

Internal and external pilot supply options

All T and V Series Valve bases incorporate an auxiliary channel "X" to supply pressure to the solenoid pilots. The "X" galley is pressurized from the left hand end plate. Depending on the configuration of the left hand end plate, this pressure is either supplied from the #1 port in the left hand end plate or supplied externally through a 4mm OD tube fitting in the left hand end plate. This fitting is supplied in all left hand end plates and can be converted in the field.

Internal and external solenoid pilot exhaust options

All T and V Series Valve bases incorporate an auxiliary channel "E" which is used to exhaust the solenoid pilot pressure from each solenoid valve. The "E" galley is connected to the left hand end plate. Depending on the configuration of the left hand end plate, this exhaust is either connected to the #3 exhaust port or is connected to a 4mm OD Tube fitting in the left hand end plate. This fitting is supplied in all left hand end plates and can be converted in the field.

To configure the left hand end plate, with pressure off, remove head cover to expose the selector section. Loosen selector section and rotate "X" or "E" channel selector to desired position. Tighten selector section and assemble cover.

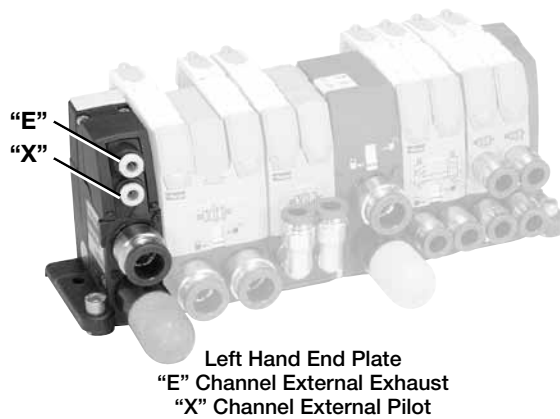
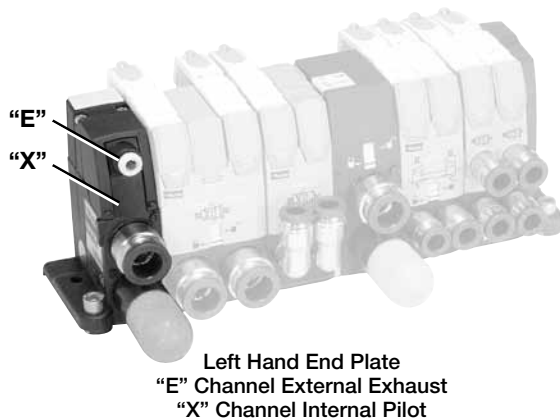
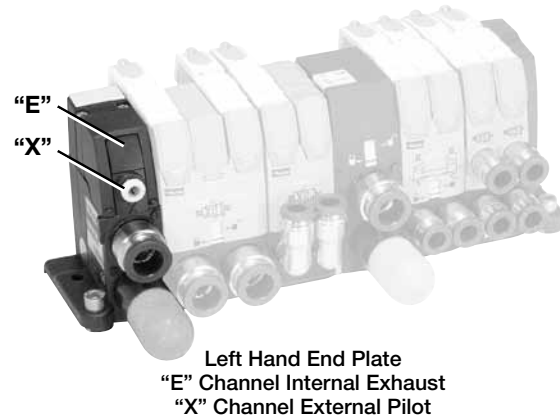
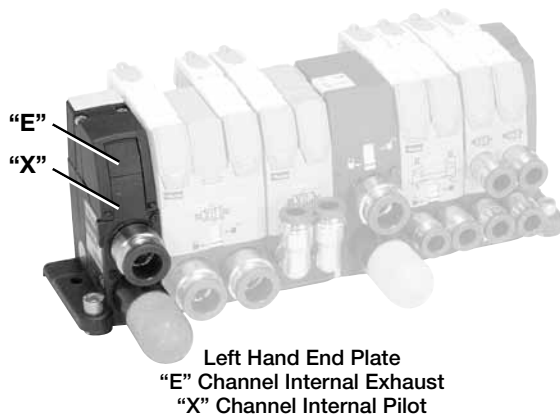
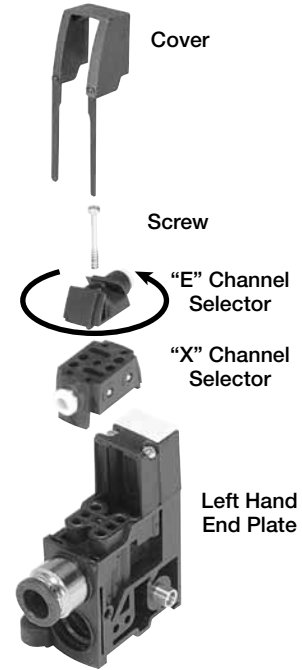

Valvoir II Series

DX ISOMAX Series

Fieldbus

Isys ISO Series

Isys Micro Series

Moduflex Series

D

Subbase & Manifold Valve Products

Solenoid Pilot 24VDC

Description	Part number
Solenoid pilot (without plug-in electrical connector)	P2D8V32C5
Air pilot with 5/32" (4mm) tube fitting	P2M2K0PA



P2D8V32C5



P2M2K0PA

Valvair II Series

DX ISOMAX Series

Fieldbus

Isys ISO Series

Isys Micro Series

Moduflex Series

D

Subbase & Manifold Valve Products

Size 1 Valve Without Solenoid Pilot and Without Subbase

4-way / 2-position / Single Valve P2M1X4EE

Solenoid	Part number
Single solenoid (Monostable)	P2M1X4ES
Double solenoid (Bistable)	P2M1X4EE



P2M1X4EE

Size 2 Valve Without Solenoid Pilot and Without Subbase

4-way / 2-position / Dual Valve P2M2X4EE

Solenoid	Part number
Single solenoid (Monostable)	P2M2X4ES
Double solenoid (Bistable)	P2M2X4EE



P2M2X4EE

4-way / 2-position / Dual Valve

Solenoid	Part number
Solenoid spring with exhaust check	P2M1XJEE

3-way / 2-position / Dual Valve

Solenoid	Part number
Double solenoid NC + NC with exhaust check	P2M1XDEE
Double solenoid NO + NO with exhaust check	P2M1XCEE
Double solenoid NC + NO with exhaust check	P2M1XEEE
Single solenoid NC with exhaust check	P2M1X3ES

3-way / 2-position / Dual Valve

Solenoid	Part number
Double solenoid NC + NC with exhaust check	P2M2XDEE
Double solenoid NO + NO with exhaust check	P2M2XCEE
Double solenoid NC + NO with exhaust check	P2M2XEEE
Single solenoid NC with exhaust check	P2M2X3ES

Set of Maintenance Parts

Description	Part number
Clips Set of 10 clips: 6 for size 1 valves, 2 for size 2 valves, 2 for end plate and intermediate modules	P2M2K0CA
Seals Set of 10 seals: 3 for manifold to manifold seals, 3 under solenoid pilot seals, 4 under valve seals (two size 1 seals, two size 2 seals)	P2M2K0JA
Forks Set of 10 isolation forks for solenoid pilot manual override	P2M2K0FA

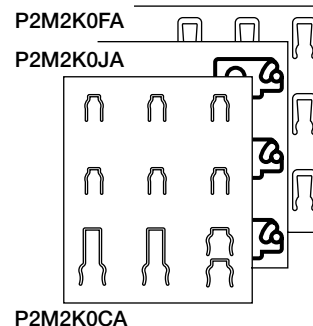

“S” Series Individual Subbase Valve Dimensions and Mounting

Subbase Valve Size 1



Subbase Valve Size 2



Surface Mounting with Screws 4 mm Dia. into Retractable Brackets 3mm Thick

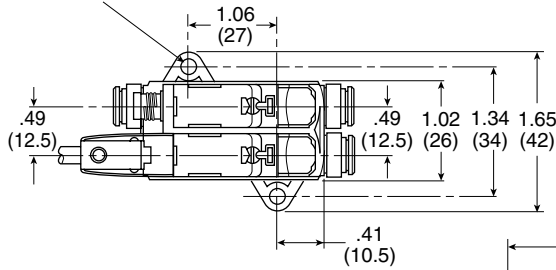

Surface Mounting with Screws 4 mm Dia. into Retractable Brackets 3mm Thick

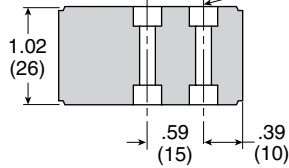
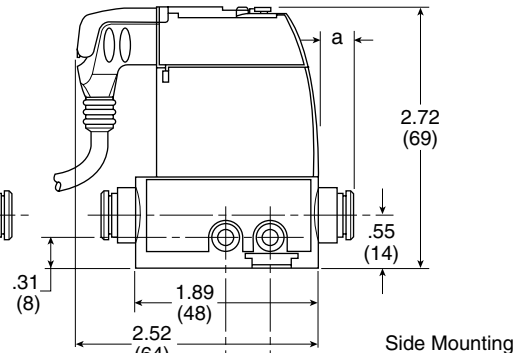
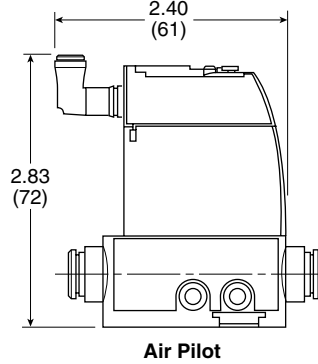
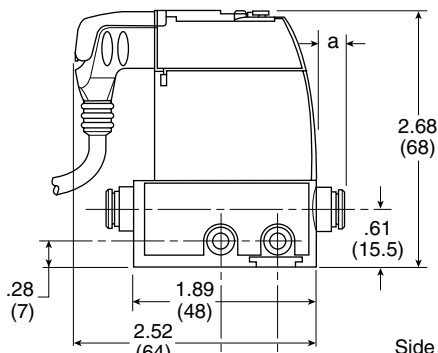
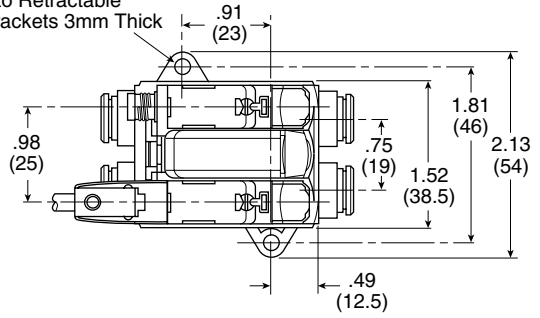

Size 1

Side Mounting with 2 Screws 4mm Dia.

Side Mounting with 2 Screws 4mm Dia.

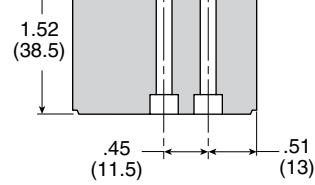

Size 2

	OD Tube Ext.	a	b	c
Size 1 Valves	5/32" (4 mm)	8	10	12
	6 mm	8	13	16
	1/4"	15	18	22
	Muffler		31	
Size 2 Valves	1/4"	12	18	22
	8 mm	9	16	19
	3/8"	16	23	26
	10 mm	13	18	22
	Muffler		40	

Special Case: 4/3 all ports blocked. Add the dual P.O. check valve that has been plugged in the basic valve.

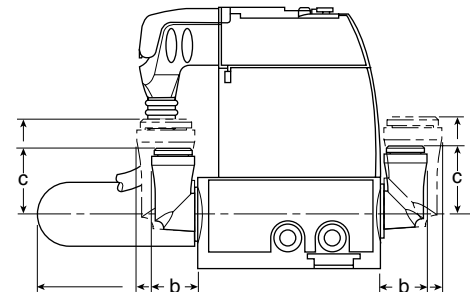

"T" Series Manifold Dimensions and Mounting

Valvair II Series
 DX ISOMAX Series
 Fieldbus
 Isys ISO Series
 Isys Micro Series
 Moduflex Series
D
 Subbase & Manifold Valve Products



Total Width Depends on Valve Composition

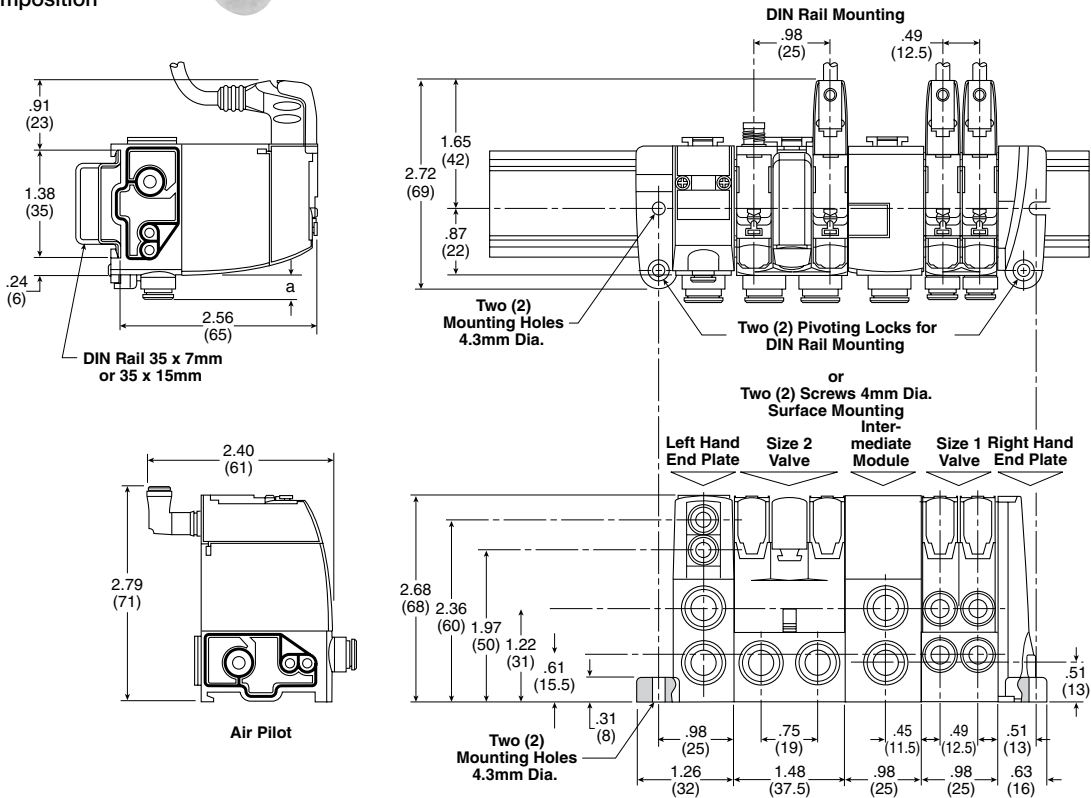

Special Case: 4/3 all ports blocked function within island version, add the dimensions of the dual P.O. check valve plugged into the island.

End Plate and Intermediate Modules

	a	b	c
6 mm Tube OD	8	13	16
1/4" Tube OD	12	18	22
8 mm Tube OD	9	16	19
3/8" Tube OD	16	23	26
10 mm Tube OD	13	18	25
12 mm Tube OD	13	19	25
1/2" Tube OD	13		
Muffler	40		

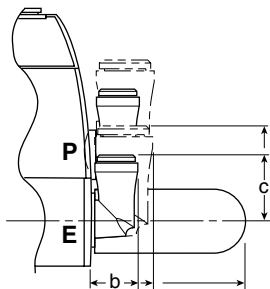

OD Tube	Ext.	a	b	c
Size 1 Valves	5/32" (4 mm)	8	10	12
	6 mm	8	13	16
	1/4"	15	18	22
Size 2 Valves	1/4"	12	18	22
	8 mm	9	16	19
	3/8"	16	23	26
10 mm	13	18	22	

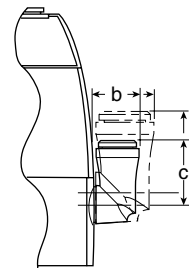

“V” Series Manifold Dimensions and Mounting
 20-pin, Multi-Connector Valve Manifold



Total Width Depends
 on Valve Composition

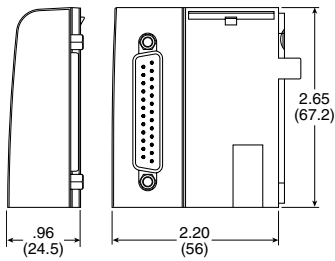
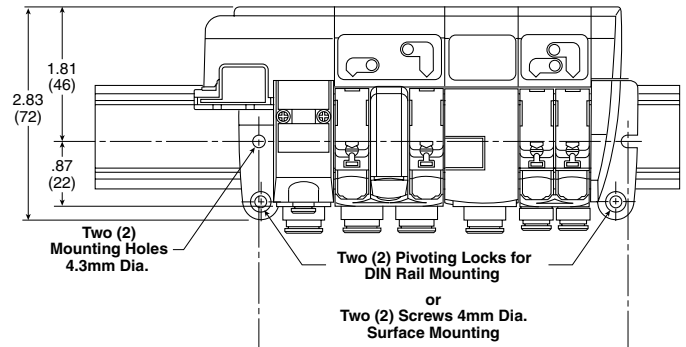
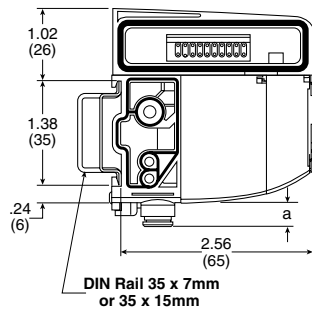

25-pin,
 D-Sub

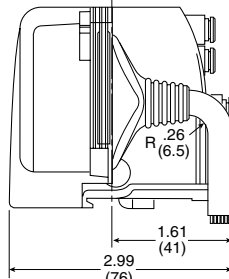

20-pin,
 Multi-Connector

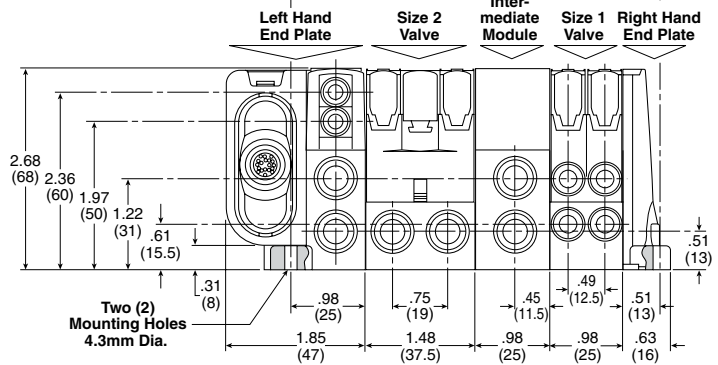

End Plate and Intermediate Modules

	a	b	c
6 mm Tube OD	8	13	16
1/4" Tube OD	12	18	22
8 mm Tube OD	9	16	19
3/8" Tube OD	16	23	26
10 mm Tube OD	13	18	25
12 mm Tube OD	13	19	25
1/2" Tube OD	13		
Muffler	40		

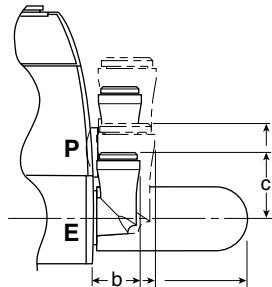

OD Tube	Ext.	a	b	c
Size 1 Modules	5/32" (4 mm)	8	10	12
	6 mm	8	13	16
Size 2 Modules	1/4"	15	18	22
	1/4"	12	18	22
	8 mm	9	16	19
	3/8"	16	23	26
	10 mm	13	18	22

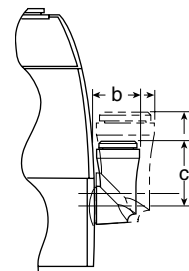

“V” Series Manifold Dimensions and Mounting
Fieldbus Connected Manifolds

Total Width Depends
on Valve Composition



Valvair II Series
DX ISOMAX Series
Fieldbus
Isys ISO Series
Isys Micro Series
Moduflex Series
D
Subbase & Manifold Valve Products

AS-i Bus Islands

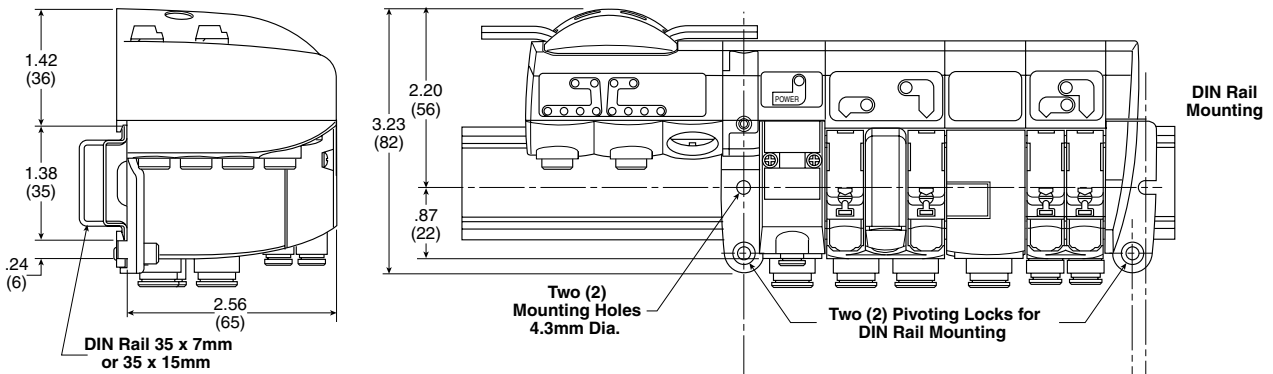

Device Bus Islands

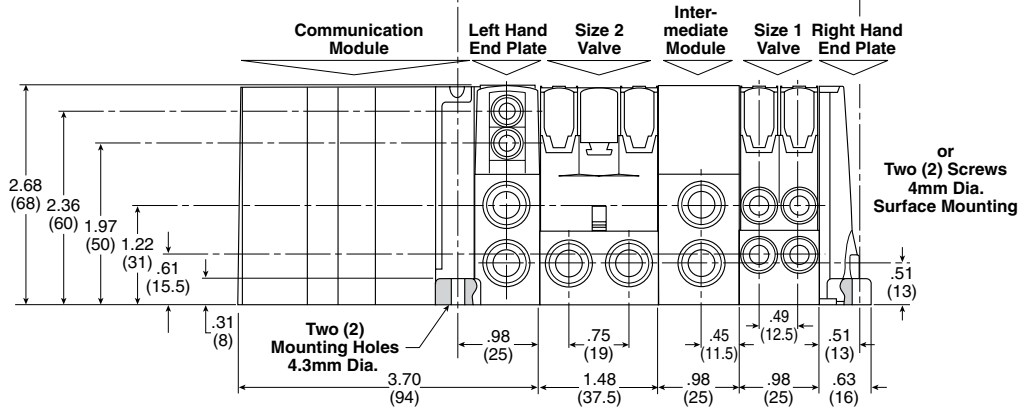
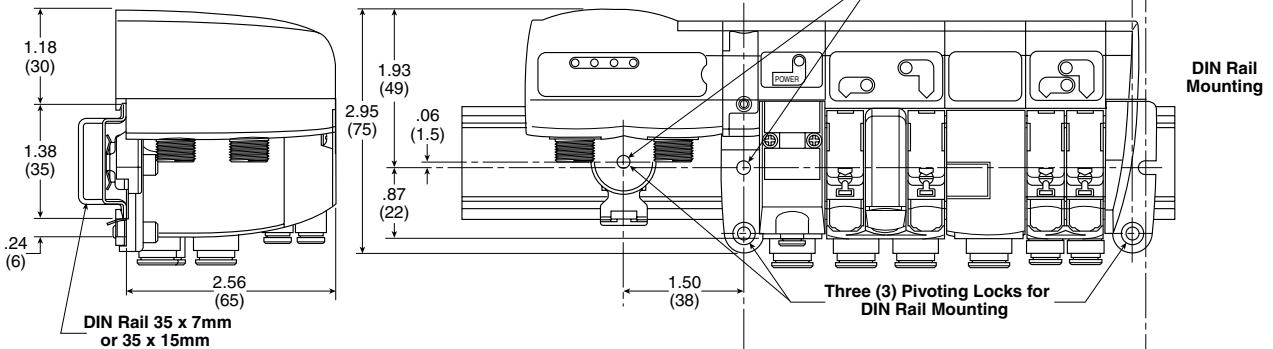

“P” Series Peripheral Modules Dimensions and Mounting

Reminder: Peripheral modules may either be plugged in the valve output ports or mounted in-line separate from the valve.

Peripheral Module Plugged in a Valve

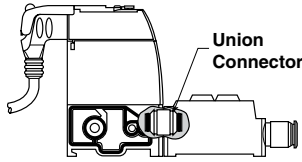

In-Line Peripheral Modules: Mounting is Required

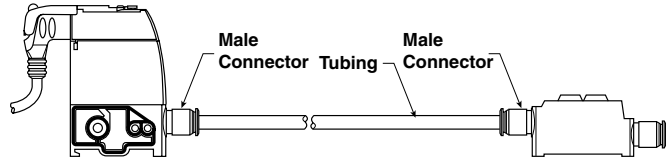

Dual Flow Control Size 1

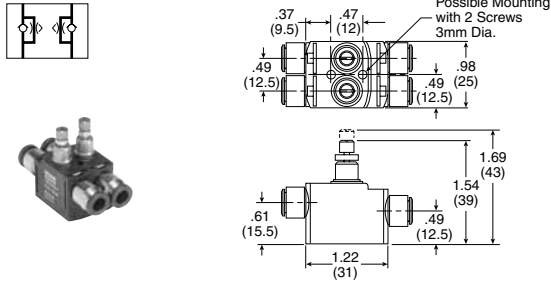

Dual Flow Control Size 2

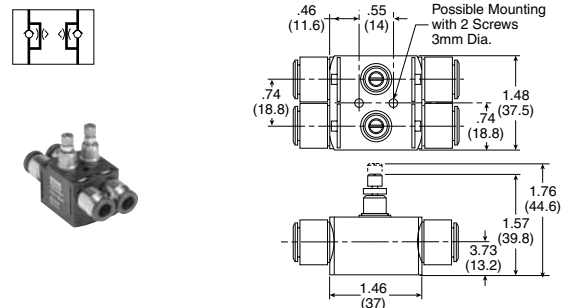

Pressure Regulator Size 1

With Gauge

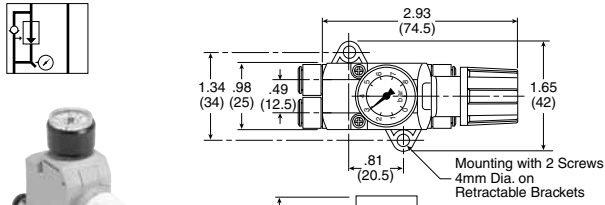

Pressure Regulator Size 2

With Gauge

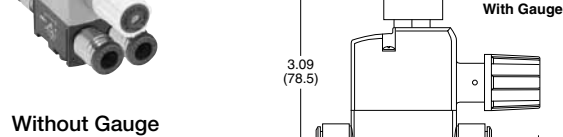
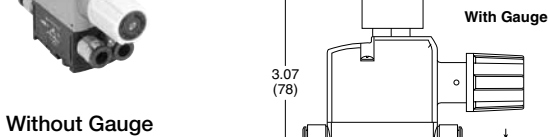
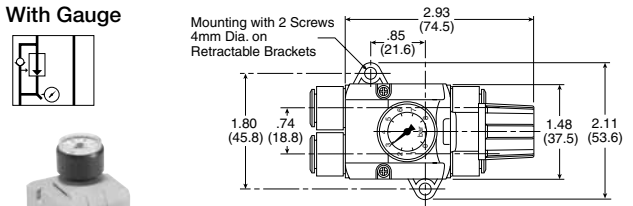

Without Gauge

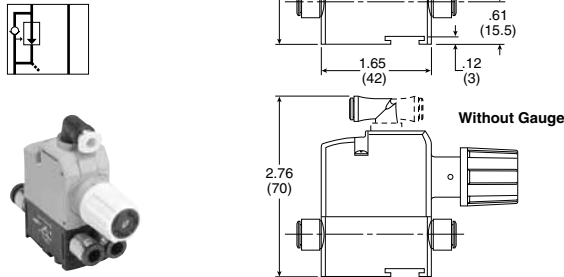

Without Gauge

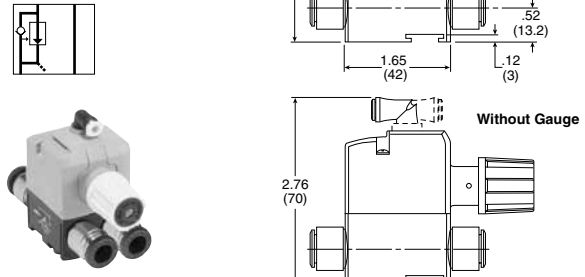

Dual P.O. Check Valve Size 1

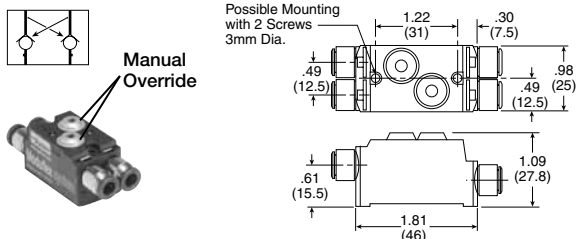

Dual P.O. Check Valve Size 2

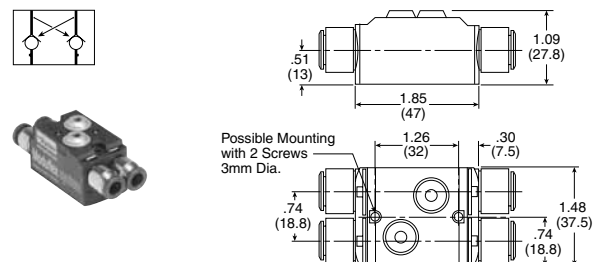

Valvair II Series

DX ISOMAX Series

Fieldbus

Isys ISO Series

Isys Micro Series

Moduflex Series

D

Subbase & Manifold Valve Products

“P” Series Peripheral Modules Dimensions and Mounting

Reminder: Peripheral modules may either be plugged in the valve output ports or mounted in-line separate from the valve.

Vacuum Generator Size 1

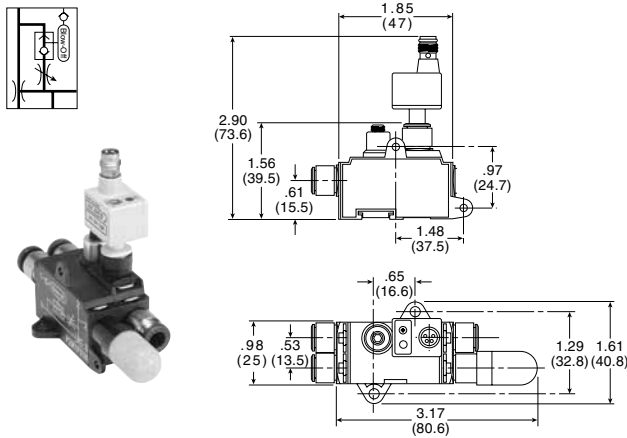

Sensor specifications

Isys ISO Series	Media	Air and non-corrosives gases
	Proof pressure	(M) 72.5 PSI
	Operating temperature	32 to 122°F (0 to 50°C)
	Storage temperature	14 to 140°F (-10 to 60°C)
Isys Micro Series	Humidity	35 to 85% RH
	Electrical connection	(C) 4-pin, M8 connector
	Power supply	10.8 to 30 VDC, ripple Vp-p 10% max., reverse voltage protection
	Switch output	1 output signal open and closed, NPN or PNP, 30VDC, 125mA
Moduflex Series	Linear output	Analog output 1 to 5 VDC
	Switch point setting	2/3 turn trimmer
	Hysteresis setting	< 2% of F.S.
	Output response time	<1ms
D Subbase & Manifold Valve Products	Repeatability	<0.2% F.S.
	Shock resistance	100 G, XYZ
	Material	Housing: Polycarbonate, pressure port: Zinc die-cast
	Mass	T Port: 0.25 oz. (7g)

Sensor pin out

- Pin #
- 1 Brown: 24VDC
 - 2 White: NPN / PNP open collector output
 - 3 Blue: 0VDC
 - 4 Black: NPN / PNP open collector output

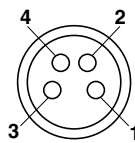

Cables

CB-M8-4P-2M, Female to Open Lead

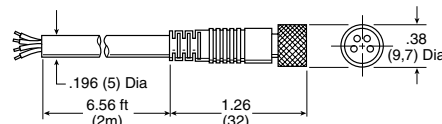

CB-M8-4P-5M, Female to Open Lead

