



OTSEGO, MICHIGAN



TIJUANA, MEXICO



ALBION, INDIANA



LAKEVIEW, MICHIGAN



MESA, ARIZONA

⚠ WARNING – USER RESPONSIBILITY

FAILURE OR IMPROPER SELECTION OR IMPROPER USE OF THE PRODUCTS DESCRIBED HEREIN OR RELATED ITEMS CAN CAUSE DEATH, PERSONAL INJURY AND PROPERTY DAMAGE.

This document and other information from Parker-Hannifin Corporation, its subsidiaries and authorized distributors provide product or system options for further investigation by users having technical expertise.

The user, through its own analysis and testing, is solely responsible for making the final selection of the system and components and assuring that all performance, endurance, maintenance, safety and warning requirements of the application are met. The user must analyze all aspects of the application, follow applicable industry standards, and follow the information concerning the product in the current product catalog and in any other materials provided from Parker or its subsidiaries or authorized distributors.

To the extent that Parker or its subsidiaries or authorized distributors provide component or system options based upon data or specifications provided by the user, the user is responsible for determining that such data and specifications are suitable and sufficient for all applications and reasonably foreseeable uses of the components or systems.

Offer of Sale

The items described in this document are hereby offered for sale by Parker Hannifin Corporation, its subsidiaries or its authorized distributors. This offer and its acceptance are governed by the provisions stated on the separate page of this document entitled "Offer of Sale".

Safe Drinking Water Act

In accordance with 42 USC § 300g-6, parts in this catalog are to be used exclusively for nonpotable services such as manufacturing, industrial processing, irrigation, outdoor watering, or any other uses where the water is not anticipated to be used for human consumption. The only exceptions are parts described explicitly as "low lead" or suitable for potable water.

Directives and Regulations

Parker complies with the directives and regulations listed below and goes beyond its statutory obligations for the ranges in question.



D.O.T. FMVSS 571.106
Fittings comply with the performance requirements



European RoHS directives: 2015/863
Relating to the limitation of the use of 10 hazardous substances in electrical and electronic equipment (Lead, Mercury, Cadmium, Hexavalent Chromium, PBB, PBDE, Bis Phthalate, BBP, DBP, DIBP).



Fittings meet the requirements of the specific SAE standard called out in the product sections



CFR 21: Code of Federal Regulation Title 21: Food and Drugs
This code consists of lists of prohibited substances for materials intended to come into contact with foodstuffs.



DIN 74324
Fittings comply with the performance requirements



Regulation 1935/2004
This framework regulation relates to materials and objects designed to come into contact with foodstuffs. It describes specific measures per product group (Art. 5).



Fittings are listed under 1 of 3 categories depending on the application. Fittings meet dimensional and testing requirements as specified by Underwriter Laboratories and carry the UL symbol.



NSF 51: NSF / ANSI-51
Fittings and tubes complying with this standard are tested and approved by NSF for contact with drinks and foodstuffs.



ISO 6149-3
Fittings meet the dimensional requirements



NSF 61: NSF / ANSI-61
Fittings and tubes complying with this standard are tested and approved by NSF for contact with drinking water.



Gold Seal Program
Fittings comply with the ANSI standards and approved by WQA for contact with drinks and foodstuffs.



NSF 42 and 58: NSF/ANSI-42/58
Tubes complying with this standard are tested and approved by NSF for drinking water treatment systems.



REACH regulation: no. 1907/2006
As product manufacturer, we are subject to article 33 of the regulation which defines a duty to inform when a candidate substance is present at more than 0.1% weight for weight.



WRAS: Water Regulations Advisory Scheme (UK) Fittings approved by this programme are declared compliant for water supply by WRc - NSF.

| Product | Type | Body Material | Temperature | | Maximum Pressure | | Tubing Size | |
|---------|------|---------------|-------------|------|------------------|-----|-------------|----|
| | | | MIN. | MAX. | PSI | BAR | IN. | MM |

Pneumatic

| | | | | | | | | |
|-----------------------------|-----------------|---------------------------|----------------|-------------------|-----|----|------------|--------|
| Prestolok Metal | Push-to-Connect | Nickel Plated Brass | 0° F (-18° C) | +200° F (+93° C) | 300 | 21 | 1/8 - 1/2 | 4 - 12 |
| Prestolok Composite | Push-to-Connect | Glass Filled Nylon | -4° F (-20° C) | +175° F (+79° C) | 290 | 20 | 1/8 - 1/2 | 3 - 14 |
| Prestolok PLM | Push-to-Connect | Nickel Plated Brass | -4° F (-20° C) | +302° F (+150° C) | 435 | 30 | 5/32 - 1/2 | 4 - 14 |
| Prestolok PLS | Push-to-Connect | Stainless Steel | -4° F (-20° C) | +302° F (+150° C) | 435 | 30 | 5/32 - 1/2 | 4 - 12 |
| Flow controls | Function | Nylon/Treated Brass | +30° F (-1° C) | +160° F (+71° C) | 145 | 10 | 1/8 - 1/2 | 4 - 14 |
| Blocking Valves | Function | Treated Brass | -4° F (-20° C) | +160° F (+71° C) | 145 | 10 | 1/8 - 3/8 | 4 - 14 |
| Slow Start Valve | Function | Nickel Plated Brass | +5° F (-15° C) | +140° F (+60° C) | 150 | 10 | 1/4 - 3/8 | 4 - 6 |
| Threshold Sensor | Function | Polymer | +5° F (-15° C) | +140° F (+60° C) | 115 | 8 | 5/32 | 4 |
| Check Valve | Function | Nylon/Nickel Plated Brass | +34° F (+1° C) | +150° F (+65° C) | 145 | 10 | 5/32 - 3/8 | 4 - 12 |
| Slide Valves | | | | | | | | |
| Quick Exhaust Valves | | Nickel-plated brass | 0° F (-18° C) | +160° F (+71° C) | 150 | 10 | 1/8 - 1/2 | - |
| Mini Ball Valves | | Nylon | -4° F (-20° C) | +175° F (+79° C) | 145 | 10 | | |

Water & Beverage

| | | | | | | | | |
|--------------------------------------|-----------------|-------------------|-----------------|-------------------|-----|----|-------------|--------|
| LIQUIfit | Push-to-Connect | Bio-based Polymer | +35° F (1° C) | +200° F (+93° C) | 230 | 16 | 1/4 - 1/2 | 4 - 12 |
| TrueSeal Acetal | Push-to-Connect | Acetal | -20° F (-29° C) | +180° F (+82° C) | 300 | 21 | 1/4 - 1/2 | - |
| TrueSeal Polypropylene | Push-to-Connect | Polypropylene | 0° F (-18° C) | +225° F (+107° C) | 150 | 10 | 1/4 - 1/2 | - |
| TrueSeal Kynar | Push-to-Connect | Kynar | 0° F (-18° C) | +275° F (+135° C) | 300 | 21 | 1/4 - 1/2 | - |
| Fast & Tite Polypropylene | Compression | Polypropylene | 0° F (-18° C) | +212° F (+100° C) | 300 | 21 | 1/4 - 5/8 | - |
| Fast & Tite Nylon | Compression | Nylon | -40° F (-40° C) | +200° F (+93° C) | 300 | 21 | 1/4 - 5/8 | - |
| Par-Barb Polypropylene | Barb | Polypropylene | 0° F (-18° C) | +212° F (+100° C) | 125 | 9 | 1/8 - 3/4 | - |
| Par-Barb Nylon | Barb | Nylon | -40° F (-40° C) | +200° F (+93° C) | 125 | 9 | 1/8 - 1 1/2 | - |
| LIQUIfit Ball Valves | Push-to-Connect | Polypropylene | +35° F (1° C) | +200° F (+93° C) | 150 | 10 | 1/4 - 3/8 | - |
| TrueSeal Ball Valves | Push-to-Connect | Polypropylene | 0° F (-18° C) | +225° F (+107° C) | 150 | 10 | 1/4 - 3/8 | - |
| Fast and Tite Ball Valves | Compression | Polypropylene | +35° F (1° C) | +200° F (+93° C) | 150 | 10 | 1/4 - 1/2 | - |
| Par-Barb Ball Valves | Barb | Polypropylene | +35° F (1° C) | +200° F (+93° C) | 150 | 10 | 1/4 - 3/8 | - |
| Check Valves | Push-to-Connect | Acetal | +34° F (+1° C) | +150° F (+65° C) | 150 | 10 | 1/4 - 3/8 | - |

Cartridges

| | | | | | | | | |
|-------------------------|-----------------|------------------|-----------------|------------------|-----|----|-----------|--------|
| Carstick | Push-to-Connect | Polymer | -4° F (-20° C) | +175° F (+79° C) | 290 | 20 | 1/8 - 3/8 | 4 - 8 |
| PLM/PLS | Push-to-Connect | Brass/ Stainless | -4° F (-20° C) | +175° F (+79° C) | 435 | 30 | - | 4 - 14 |
| LIQUIfit | Push-to-Connect | Polymer | + 35° F (+1° C) | +200° F (+93° C) | 230 | 16 | 1/4 - 1/2 | 4 - 12 |
| TrueSeal | Push-to-Connect | Acetal | -20° F (-29° C) | +180° F (+82° C) | 150 | 10 | 1/4 - 1/2 | - |
| SAE Encapsulated | Push-to-Connect | Brass | -40° F (-40° C) | +200° F (+93° C) | 250 | 17 | 1/4 - 5/8 | - |

Transportation Push-to-Connect

| | | | | | | | | |
|------------------------------------|-----------------|-----------|-----------------|-------------------|-----|-----|------------|--------|
| PTC Brass Fittings | Push-to-Connect | Brass | -40° F (-40° C) | +200° F (+93° C) | 250 | 17 | 5/32 - 3/4 | - |
| PTC/PTCR Composite Fittings | Push-to-Connect | Composite | -40° F (-40° C) | +200° F (+93° C) | 250 | 17 | 1/4 - 3/4 | - |
| Metric Prestomatic | Push-to-Connect | Brass | -40° F (-40° C) | +200° F (+93° C) | 250 | 17 | - | 4 - 16 |
| Parker Safe Lock | | | -40° F (-40° C) | +239° F (+115° C) | 72 | 4.9 | | |

WARNING These products can expose you to chemicals including NICKEL, CARBON BLACK, TITANIUM DIOXIDE, or LEAD, which are known to the state of California to cause cancer, and LEAD which is known to cause birth defects or other reproductive harm. For more information go to www.P65Warnings.ca.gov.

| Product | Type | Body Material | Temperature | | Maximum Pressure | | Tubing Size | |
|---------|------|---------------|-------------|------|------------------|-----|-------------|----|
| | | | MIN. | MAX. | PSI | BAR | IN. | MM |

Transportation Compression

| | | | | | | | | |
|--------------------------------------|----------------|-------|-----------------|-------------------|--------------|--------------|------------|---|
| NTA | Compression | Brass | -40° F (-40° C) | +200° F (+93° C) | 150 | 10 | 3/16 - 3/4 | - |
| Transmission | Compression | Brass | -40° F (-40° C) | +220° F (+104° C) | 150 | 10 | 1/8 - 5/32 | - |
| Air Brake - AB | Compression | Brass | -65° F (-54° C) | +250° F (+121° C) | 400 | 27 | 1/4 - 3/4 | - |
| Air Brake Hose Ends | Compression | Brass | -50° F (-45° C) | +212° F (+100° C) | 225 | 15 | 3/8 - 1/2 | - |
| Vibra-Lok Buna N Sleeve | Compression | Brass | -30° F (-34° C) | +275° F (+135° C) | On Condition | On Condition | 1/8 - 3/4 | - |
| Vibra-Lok Fluorocarbon Sleeve | Compression | Brass | -15° F (-26° C) | +450° F (+232° C) | On Condition | On Condition | 1/8 - 3/4 | - |
| Truck Valves | Shut Off | Brass | -30° F (-34° C) | +250° F (+121° C) | 150 | 10 | 3/8 - 3/4 | - |
| Lanyard Valve | Manual Release | Brass | -40° F (-40° C) | +200° F (+93° C) | 150 | 10 | - | - |

Transportation Cartridges & Manifolds

| | | | | | | | | |
|-----------------------------------|-----------------|--------------------|-----------------|------------------|-----|----|------------|---|
| SAE Encapsulated Cartridge | Push-to-Connect | Brass | -40° F (-40° C) | +200° F (+93° C) | 250 | 17 | 5/32 - 3/4 | - |
| Presto Manifold | Push-to-Connect | Glass Filled Nylon | -40° F (-40° C) | +200° F (+93° C) | 150 | 10 | 1/4 - 1/2 | - |

Industrial Compression Style

| | | | | | | | | |
|---------------------------|-------------|-------|-----------------|-------------------|------|-----|-----------|--------|
| Compression | Compression | Brass | -65° F (-54° C) | +250° F (+121° C) | 2800 | 193 | 1/8 - 7/8 | |
| Compress-Align | Compression | Brass | -65° F (-54° C) | +250° F (+121° C) | 2800 | 193 | 1/8 - 1 | |
| Metric Compression | Compression | Brass | -40° F (-40° C) | +482° F (+250° C) | 3335 | 230 | | 4 - 22 |
| Poly-Tite | Compression | Brass | 0° F (-18° C) | +150° F (+65° C) | 150 | 10 | 1/4 - 1/2 | |
| Hi-Duty | Compression | Brass | -65° F (-54° C) | +250° F (+121° C) | 4300 | 296 | 1/8 - 5/8 | |

Industrial Flare Fittings

| | | | | | | | | |
|-----------------------|-------|-------|-----------------|-------------------|------|-----|-----------|--|
| 45° Flare | Flare | Brass | -65° F (-54° C) | +250° F (+121° C) | 2800 | 193 | 1/8 - 7/8 | |
| Inverted Flare | Flare | Brass | -65° F (-54° C) | +250° F (+121° C) | 2800 | 193 | 1/8 - 3/4 | |
| Access Valves | Flare | Brass | -20° F (-29° C) | +200° F (+93° C) | 500 | 34 | 1/8 - 1/2 | |

Industrial Barbed Fittings

| | | | | | | | | |
|-------------------|--------|-------|-----------------|--|------------------------------|---------------------------|---------|--|
| Dubl-Barb | Barbed | Brass | -65° F (-54° C) | (1/4-3/8) - +90° F (+32° C) (1/2) - +75° F (+24° C) | (1/4 - 3/8) 150 (1/2) 100 | (1/4 - 3/8) 10 (1/2) 7 | | |
| Hose Barbs | Barbed | Brass | -40° F (-40° C) | +160° F (+71° C) | 150 | 10 | 1/4 - 1 | |

Industrial Adapters

| | | | | | | | | |
|--------------------------|----------|-------|--|-------------------|-------|----|---------|--|
| Pipe | Threaded | Brass | -65° F (-54° C) | +250° F (+121° C) | 1,000 | 69 | 1/8 - 1 | |
| ISO Port Adapters | | Brass | Dependent on Tubing or Hose End Connection | | | | | |
| Garden Hose | | Brass | +35° F (+2° C) | +100° F (+38° C) | 75 | 5 | | |

NOTE: DO NOT ALLOW MEDIA TO FREEZE OR PRODUCT DAMAGE MAY OCCUR. REFER TO USER RESPONSIBILITY ON PAGE 0.

WARNING These products can expose you to chemicals including NICKEL, CARBON BLACK, TITANIUM DIOXIDE, or LEAD, which are known to the state of California to cause cancer, and LEAD which is known to cause birth defects or other reproductive harm. For more information go to www.P65Warnings.ca.gov.



| Product | Type | Body Material | Temperature | | Maximum Pressure | | Tubing Size | |
|---------|------|---------------|-------------|------|------------------|-----|-------------|----|
| | | | MIN. | MAX. | PSI | BAR | IN. | MM |

Industrial Ball Valves

| | | | | | | | | |
|---------------------------|-----------------------------|---------------------|-----------------|-------------------|--------------------------------------|----------------------------------|--|--|
| 500 Series | Female/Female | Brass | 0° F (-18° C) | +350° F (+176° C) | 600 | 41 | | |
| 501 Series | Female/Male | Brass | 0° F (-18° C) | +350° F (+176° C) | 600 | 41 | | |
| 502 Series | Panel Mounted | Brass | 0° F (-18° C) | +350° F (+176° C) | 600 | 41 | | |
| 506 Series | Straight Thread | Brass | 0° F (-18° C) | +350° F (+176° C) | 600 | 41 | | |
| 509 Series | Solder Ends | Brass | | | | | | |
| 510 Series | Male/Female Straight Thread | Brass | 0° F (-18° C) | +350° F (+176° C) | 600 | 41 | | |
| 520 Series | Female/Female | Brass | 0° F (-18° C) | +350° F (+176° C) | 600 | 41 | | |
| 525 Series | Female/Female | Brass | -40° F (-40° C) | +350° F (+176° C) | 600 | 41 | | |
| 533 Series | 3-Way Diversion | Brass | -20° F (-29° C) | +350° F (+176° C) | 400 | 27 | | |
| 540 Series | 4-Way | Brass | -20° F (-29° C) | +350° F (+176° C) | 400 | 27 | | |
| 590/591 Series | Right Angle | Brass | -50° F (-45° C) | +350° F (+176° C) | 250 | 17 | | |
| 500HB Series | Hose Barb | Brass | 0° F (-18° C) | +350° F (+176° C) | 150 | 10 | | |
| 600 Series | Six Port Diversion | Brass | 0° F (-18° C) | +250° F (+121° C) | 150 | 10 | | |
| 500CS/502CS Series | Female/Female | Carbon Steel | -20° F (-29° C) | +425° F (+218° C) | 2,000 (1/4 - 1) 1,500 (1 1/4 - 2) | 137 (1/4 - 1) 103 (1 1/4 - 2) | | |
| 506CS Series | Straight Thread | Carbon Steel | -20° F (-29° C) | +425° F (+218° C) | 3,000 | 206 | | |
| 500HP/506HP Series | High Pressure | Carbon Steel | -10° F (-23° C) | +210° F (+99° C) | 6,000 | 413 | | |
| 501SS | Male/ Female | Stainless Steel | 0° F (-18° C) | +400° F (+204° C) | 2,000 | 137 | | |
| 502SS | Female/Female | Stainless Steel | 0° F (-18° C) | +400° F (+204° C) | 2,000 (1/4 - 1) 1,500 (1 1/4 - 2) | 137 (1/4 - 1) 103 (1 1/4 - 2) | | |
| 708 Series | Male/Female | Brass | -35° F (-37° C) | +300° F (+148° C) | 500 | 34 | | |
| 709 Series | Female/Female | Brass | -35° F (-37° C) | +300° F (+148° C) | 500 | 34 | | |
| 200 Series | Female/Female | Chrome Plated Brass | 0° F (-18° C) | +200° F (+93° C) | 200 | 13 | | |
| 608 Series | Male/Female | Brass | 0° F (-18° C) | +200° F (+93° C) | 450 | 31 | | |
| 609 Series | Female/Female | Brass | 0° F (-18° C) | +200° F (+93° C) | 450 | 31 | | |
| Mini Ball Valves | | Nylon | -4° F (-20° C) | +175° F (+79° C) | 145 | 10 | | |

Plug Valves

| | | | | | | | | |
|-------------------|---------------|-------|-----------------|------------------|-----|----|--|--|
| 607 Series | Male/Male | Brass | -40° F (-40° C) | +175° F (+79° C) | 250 | 17 | | |
| 608 Series | Male/Female | Brass | -40° F (-40° C) | +175° F (+79° C) | 250 | 17 | | |
| 609 Series | Female/Female | Brass | -40° F (-40° C) | +175° F (+79° C) | 250 | 17 | | |

Needle Valves/Drain Cocks/ Ground Plug Shutoff

| | | | | | | | | |
|----------------------------|-------------------|-------|-----------------|-------------------|-----|----|--|--|
| Needle Valves | Shutoff | Brass | -45° F (-42° C) | +250° F (+121° C) | 150 | 10 | | |
| Drain Cocks | External/Internal | Brass | -65° F (-54° C) | +250° F (+121° C) | 150 | 10 | | |
| Ground Plug Shutoff | Shutoff | Brass | +32° F (0° C) | +125° F (+51° C) | 30 | 2 | | |

WARNING These products can expose you to chemicals including NICKEL, CARBON BLACK, TITANIUM DIOXIDE, or LEAD, which are known to the state of California to cause cancer, and LEAD which is known to cause birth defects or other reproductive harm. For more information go to www.P65Warnings.ca.gov.



Parker
W51PLP-4-4
MALE ELBOW

Parker
W51PLP-4-4
MALE CONNECTOR

Parker
215PML-2-25
LONG NIPPLE

Parker
215PML-2-25
LONG NIPPLE

Parker
W51PW-4-4
MALE CONNECTOR

Parker
W51PW-4-2
MALE CONNECTOR

Parker
164PLP-4
UNION TEE

Parker
W172PW-4-2
MALE BRANCH TEE

Parker
517P-4
NUT NIPPLE

Parker
517P-4
UNION

Parker
517PW-4
UNION BULKHEAD

Parker
08-4
DUST BOOT

Parker
64C-4-4
MALE CONNECTOR

Parker
64C-4-4
MALE CONNECTOR

Parker
64C-4-2
MALE CONNECTOR

- A
- B
- C
- D
- E
- F
- G
- H
- I
- J
- K
- L
- M
- N
- O



Pneumatic: Push-to-Connect

Section A

| | |
|--|--|
| Prestolok PLP Metal Push-to-Connect Fittings | Prestolok PLM Metal Push-to-Connect Fittings |
| Prestolok PLP Composite Push-to-Connect Fittings | Prestolok PLS Stainless Steel Push-to-Connect Fittings |
| Oscillating Elbows | |



Pneumatic: Integrated Fittings

Section B

| | | |
|-----------------------------|-------------------------------|---------------------------|
| Compact Flow Controls | Stainless Steel | Quick Exhaust Valve |
| Miniature Flow Controls | Flow Controls | Blocking Valves |
| Swivel Outlet Flow Controls | In-Line Check Valves | Slow Start Valves |
| Plug-In Flow Controls | Stainless Steel Check Valves | Threshold Sensor Fittings |
| In-Line Flow Controls | Piloted Operated Check Valves | Mini Ball Valves |
| Metal Flow Controls | Pneumatic Slide Valves | |



Water & Beverage: Thermoplastic Fittings and Valves

Section C

| | | |
|--------------------|-----------------------|---------------------------|
| LIQUIfit Fittings | Fast & Tite® Fittings | Thermoplastic Ball Valves |
| TrueSeal™ Fittings | Par-Barb® Fittings | |



Cartridges

Section D

| | | |
|----------------------|----------------------|-----------------------------|
| Cartridges | LIQUIfit® Cartridges | PLM/PLS Cartridges |
| Carstick® Cartridges | TrueSeal™ Cartridges | SAE Encapsulated Cartridges |



Transportation Push-to-Connect

Section E

| | |
|-----------------------------|-----------------------------|
| PTC/PTCR Composite Fittings | Metric Prestomatic Fittings |
| PTC Brass Fittings | Parker Safe Lock |



Transportation Compression Fittings & Valves

Section F

| | | |
|-------------------------|------------------------------|------------------------------|
| Air Brake—NTA® Fittings | Air Brake – AB Fittings | Vibra-Lok Fittings |
| Transmission Fittings | Air Brake Hose Ends Fittings | Truck Valves & Lanyard Valve |



Industrial Compression Style Fittings

Section G

| | | |
|--------------------------|--------------------------|---------------------------------|
| Compression Fittings | Brass Metric Compression | Hi-Duty Flareless Tube Fittings |
| Compress-Align® Fittings | Poly-Tite Fittings | |



Industrial Flare Fittings

Section H

| | | |
|--------------------|-------------------------|---------------|
| 45° Flare Fittings | Inverted Flare Fittings | Access Valves |
|--------------------|-------------------------|---------------|

WARNING These products can expose you to chemicals including NICKEL, CARBON BLACK, TITANIUM DIOXIDE, or LEAD, which are known to the state of California to cause cancer, and LEAD which is known to cause birth defects or other reproductive harm. For more information go to www.P65Warnings.ca.gov.

| | | |
|-----------------------------------|--------------------|-----------|
| Industrial Barbed Fittings | | Section I |
| Dubl-Barb® Fittings | Hose Barb Fittings | |



| | | | |
|----------------------------|-------------------------------|----------------------|-----------|
| Industrial Adapters | | | Section J |
| Pipe Fittings | Nickel Plated Metric Adapters | Garden Hose Fittings | |
| Metric Adapters | ISO Port Adapters | | |



| | | |
|--|--|-----------|
| Industrial Valves | | Section K |
| Ball Valves Brass Series 500 | Ball Valves Stainless Steel Series 501SS | |
| Ball Valves Brass Series 501 | Ball Valves Stainless Steel Series 502SS | |
| Ball Valves Brass Series 502 | Ball Valves Micro Series 708/709 | |
| Ball Valve Brass Series 506 | Ball Valves Mini Series 200/608/609 | |
| Ball Valves Brass Series 509 | Ball Valves Polypropylene | |
| Ball Valves Brass Series 510 | Plug Valves Series PV | |
| Ball Valves Brass Series 520 | Ball Valves Rotary Actuator Series ACT | |
| Ball Valves Brass Series 525 | Ball Valve Series BVGC | |
| Ball Valves Brass Series 533 | Ball Valve Series BVGL | |
| 3-Way Diversion / Series 540 4-Way | Ball Valve Series BVGLOCK | |
| Ball Valves Brass Series 590/591 | Ball Valve Series MBVG | |
| Ball Valves Brass Series 500HB | Axial Valves | |
| Ball Valves Brass Series 600 | Replacement Componentry | |
| Ball Valves Carbon Steel Series 500CS/502CS | Ball Valve Stem Extensions Series STX | |
| Ball Valves Carbon Steel Series 506CS | Needle Valves | |
| Ball Valves Carbon Steel Series 500HP, 506HP | Drain Cocks/Ground Plug Shutoff | |



| | | | |
|--------------------|-----------|----------------------------|-----------|
| Accessories | | | Section L |
| Blow Guns | Silencers | Bins, Bags & Copper Tubing | |



| | | | |
|-----------------------------------|---------------------------|----------------------------|-----------|
| Tube Fabricating Equipment | | | Section M |
| Tube Cutters | Metric Tube Benders | Flaring Tools | |
| Kloskut Tube Cutters | Tube Benders, Spring Type | In-Ex® Tube Deburring Tool | |
| Tube Benders, Lever Type | | | |



| | | |
|--------------------------|--|-----------|
| General Technical | | Section N |
|--------------------------|--|-----------|

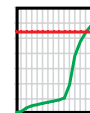

WARNING These products can expose you to chemicals including NICKEL, CARBON BLACK, TITANIUM DIOXIDE, or LEAD, which are known to the state of California to cause cancer, and LEAD which is known to cause birth defects or other reproductive harm. For more information go to www.P65Warnings.ca.gov.





Pneumatic: Push to Connect

Prestolok PLP Metal
Push-to-Connect Fittings

Prestolok PLP Composite
Push-to-Connect Fittings

Oscillating Elbows

Prestolok PLM Metal
Push-to-Connect Fittings

Prestolok PLS
Stainless Steel
Push-to-Connect Fittings



For more product information visit:
www.parker.com/automation-fittings



A

B

C

D

E

F

G

H

I

J

K

L

M

N

O



Prestolok PLP Metal Push-to-Connect Fittings

Prestolok PLP metal push-to-connect fittings offers a wide variety of configurations, allowing you to find the perfect product to meet your needs, optimizing the use of your equipment.

Product Features:

- Stainless steel grab ring
- Nickel-plated brass body
- Nitrile seal
- Flame resistant release button
- Corrosion resistance
- Inch and metric tube connections
- NPT, BSPP, BSPT, and metric threads

Markets:

- Industrial
- Automotive
- Climate Control
- Welding
- Robotic Welding

Compatible Media:

- Air
- Oil
- Inert Gases

Specifications:

| | |
|--------------------------|---|
| Pressure Range | Up to 300 PSI (20.6 bar) depending on tubing |
| Temperature Range | 0° to +200° F (-17.7° to 93.3° C) |
| Vacuum Rating | 28" Hg |

Note: Vacuum applications are dependent upon temperature and type of tubing used
Note: Maximum pressure and temperature range depend on the type of tubing used.

Compatible Tubing:

- 95FR Microweld
- Polyethylene
- Polypropylene
- Semi Rigid Nylon
- Rigid Nylon
- Polyurethane 95 Durometer Shore A

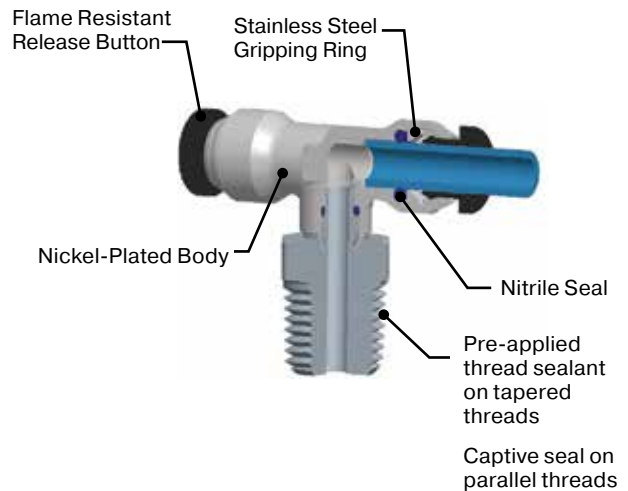

Assembly Instructions

1. Cut tubing squarely – maximum of 15° angle allowable.
2. Check that port or mating part is clean and free of debris.
3. Mark tubing to appropriate tube insertion length. (see Tube Insertion Chart on page 15)
4. Insert tubing until it bottoms
5. Pull on tubing to verify it is fully inserted
6. To disassemble, simply press release button, hold against body and pull tubing out of fitting.

WARNING These products can expose you to chemicals including LEAD which is known to the state of California to cause cancer and birth defects or other reproductive harm. For more information go to www.P65Warnings.ca.gov.



Threaded Fittings

66PLP

Female Connector – NPTF
p. A8



66PLP

Female Connector – BSPP
p. A8



W68PLP

Male Connector – NPTF
p. A9



W68PLP

Male Connector – BSPT
p. A9



68PLP

Male Connector – BSPP
p. A9



68PLP

Male Connector – BSPP
p. A10



68PLPR

Round Male Connector – NPTF/UNF
p. A10



68PLPR

Round Male Connector – BSPP/M5
p. A10



W169PLP

Male Elbow Swivel 90° – NPTF
p. A11



W169PLP

Male Elbow Swivel 90° – BSPT
p. A12



W169PLPNS

Male Elbow 90° – NPTF
p. A12



169PLP

Male Elbow Swivel 90° – BSPP
p. A12



W171PLP

Male Run Tee Swivel – NPTF
p. A13



W171PLP

Male Run Tee Swivel – BSPT
p. A13



171PLP

Male Run Tee Swivel – BSPP
p. A13



W172PLP

Male Branch Tee Swivel – NPTF
p. A14



W172PLP

Male Branch Tee Swivel – BSPT
p. A14



172PLP

Male Branch Tee Swivel – BSPP
p. A14



Tube to Tube Fittings

62PLP

Union – Inch
p. A7



62PLP

Union – Metric
p. A7



62PLP

Unequal Union – Inch
p. A7



62PLP

Unequal Union – Metric
p. A7



164PLP

Union Tee – Inch
p. A10



164PLP

Union Tee – Metric
p. A10



165PLP

Union Elbow – Inch
p. A11



165PLP

Union Elbow – Metric
p. A11



362PW

Union Y (PVDF) – Inch
p. A15



362PW

Union Y (PVDF) – Metric
p. A15



Bulkhead Unions

62PLPBH

Bulkhead Union – Inch
p. A7



62PLPBH

Bulkhead Union – Metric
p. A7



66PLPBH

Female Bulkhead – NPTF
p. A8



66PLPBH

Female Bulkhead – BSPP
p. A8



WARNING These products can expose you to chemicals including LEAD which is known to the state of California to cause cancer and birth defects or other reproductive harm. For more information go to www.P65Warnings.ca.gov.



A

B

C

D

E

F

G

H

I

J

K

L

M

N

O

- A
- B
- C
- D
- E
- F
- G
- H
- I
- J
- K
- L
- M
- N
- O

■ **Plug-In Fittings**

62PLPSP

Tube Expander – Inch
p. A15



62PLPSP

Tube Expander – Metric
p. A15



67PLP

Tube Reducer – Inch
p. A15



67PLP

Tube Reducer – Metric
p. A15



■ **Accessories**

139PLP

Plug – Metric
p. A15



TPL

Plug (PVDF) – Inch
p. A15



DB

Dust/Weld Spatter Boot
p. A16



3000 71 00

Tube Cutter
p. A16



PTC-001

Tube Cutter
p. A16



AQRT

Quick Release Tool
p. A16



0139

Bi-Material Captive Sealing Washer BSPP
p. A16



WARNING These products can expose you to chemicals including LEAD which is known to the state of California to cause cancer and birth defects or other reproductive harm. For more information go to www.P65Warnings.ca.gov.



[Click here for CADs, Product Specifications or to Configure Parts Online](#)

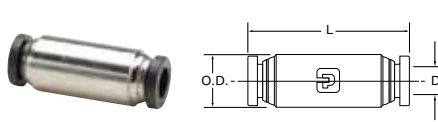

62PLP Union – Inch

| PART NO. | TUBE SIZE IN | O.D. | L | FLOW DIA. D |
|------------|--------------|------|------|-------------|
| 62PLP-2 | 1/8 | .375 | 1.40 | .094 |
| 62PLP-3 | 3/16 | .437 | 1.41 | .156 |
| 62PLP-5/32 | 5/32 | .375 | 1.41 | .125 |
| 62PLP-4 | 1/4 | .500 | 1.43 | .188 |
| 62PLP-5 | 5/16 | .562 | 1.65 | .250 |
| 62PLP-6 | 3/8 | .625 | 1.66 | .312 |
| 62PLP-8 | 1/2 | .750 | 1.82 | .375 |

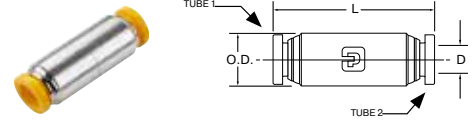

62PLP Unequal Union – Metric

| PART NO. | TUBE 1 SIZE IN | TUBE 2 SIZE IN | O.D. | L MM | FLOW DIA. D |
|---------------|----------------|----------------|-------|-------|-------------|
| 62PLP-4M-6M | 4 | 6 | 12.70 | 34.94 | 4.17 |
| 62PLP-6M-8M | 6 | 8 | 14.27 | 40.59 | 6.22 |
| 62PLP-8M-10M | 8 | 10 | 17.46 | 41.36 | 10.26 |
| 62PLP-10M-12M | 10 | 12 | 19.05 | 44.42 | 12.24 |

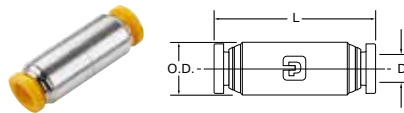

62PLP Union – Metric

| PART NO. | TUBE SIZE MM | O.D. | L IN | FLOW DIA. D |
|-----------|--------------|-------|------|-------------|
| 62PLP-4M | 4 | 9.53 | 35.5 | 3.175 |
| 62PLP-6M | 6 | 12.70 | 34.4 | 4.775 |
| 62PLP-8M | 8 | 14.27 | 41.8 | 6.350 |
| 62PLP-10M | 10 | 17.46 | 40.9 | 7.925 |
| 62PLP-12M | 12 | 19.05 | 40.9 | 9.525 |

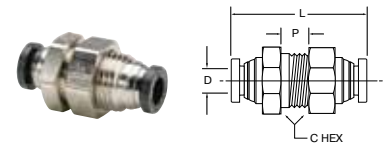

62PLPBH Bulkhead Union – Inch

| PART NO. | TUBE SIZE IN | BULKHEAD HOLE DIA. B | C HEX | P MAX. | L | D |
|--------------|--------------|----------------------|-------|--------|------|------|
| 62PLPBH-2 | 1/8 | 7/16 | 9/16 | .39 | 1.40 | .094 |
| 62PLPBH-5/32 | 5/32 | 7/16 | 9/16 | .39 | 1.41 | .125 |
| 62PLPBH-4 | 1/4 | 9/16 | 11/16 | .29 | 1.43 | .188 |
| 62PLPBH-5 | 5/16 | 5/8 | 3/4 | .60 | 1.65 | .250 |
| 62PLPBH-6 | 3/8 | 3/4 | 7/8 | .54 | 1.66 | .312 |
| 62PLPBH-8 | 1/2 | 7/8 | 1 | .66 | 2.04 | .375 |

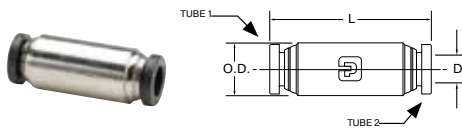

62PLP Unequal Union – Inch

| PART NO. | TUBE 1 SIZE IN | TUBE 2 SIZE IN | O.D. | L | FLOW DIA. D |
|--------------|----------------|----------------|------|------|-------------|
| 62PLP-5/32-2 | 5/32 | 1/8 | .375 | 1.41 | .094 |
| 62PLP-4-2 | 1/4 | 1/8 | .500 | 1.43 | .094 |
| 62PLP-4-5/32 | 1/4 | 5/32 | .500 | 1.43 | .125 |
| 62PLP-4-6 | 1/4 | 3/8 | .625 | 1.66 | .188 |
| 62PLP-6-8 | 3/8 | 1/2 | .750 | 1.82 | .312 |

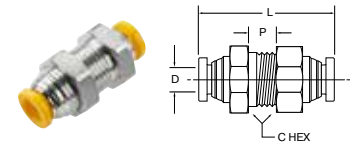

62PLPBH Bulkhead Union – Metric

| PART NO. | TUBE SIZE MM | BULKHEAD HOLE DIA. B | C HEX | P MAX. | L MM | D MM |
|-------------|--------------|----------------------|-------|--------|-------|-------|
| 62PLPBH-4M | 4 | 11 | 9/16 | 9.68 | 35.49 | 3.175 |
| 62PLPBH-6M | 6 | 14 | 11/16 | 7.57 | 34.07 | 4.775 |
| 62PLPBH-8M | 8 | 16 | 3/4 | 14.67 | 41.79 | 6.350 |
| 62PLPBH-10M | 10 | 19 | 7/8 | 11.66 | 40.91 | 7.925 |
| 62PLPBH-12M | 12 | 22 | 1 | 14.99 | 50.94 | 9.525 |

WARNING These products can expose you to chemicals including LEAD which is known to the state of California to cause cancer and birth defects or other reproductive harm. For more information go to www.P65Warnings.ca.gov.



- A
- B
- C
- D
- E
- F
- G
- H
- I
- J
- K
- L
- M
- N
- O

[Click here for CADs, Product Specifications or to Configure Parts Online](#)

- A
- B
- C
- D
- E
- F
- G
- H
- I
- J
- K
- L
- M
- N
- O

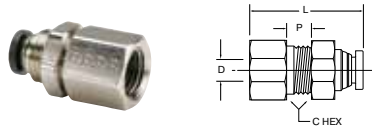

66PLPBH Female Bulkhead – NPTF

| PART NO. | TUBE SIZE IN | PIPE THD NPTF | C HEX | P MAX. | L | FLOW DIA. D | BKHD HOLE DIA. |
|----------------|--------------|---------------|-------|--------|------|-------------|----------------|
| 66PLPBH-5/32-4 | 5/32 | 1/4 | 11/16 | .19 | 1.39 | .125 | 1/2 |
| 66PLPBH-4-4 | 1/4 | 1/4 | 11/16 | .24 | 1.35 | .188 | 9/16 |
| 66PLPBH-6-6 | 3/8 | 3/8 | 1 | .22 | 1.47 | .312 | 7/8 |
| 66PLPBH-8-6 | 1/2 | 3/8 | 1 | .35 | 1.56 | .344 | 7/8 |

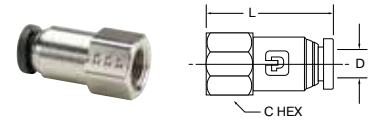

66PLP Female Connector – NPTF

| PART NO. | TUBE SIZE IN | PIPE THREAD NPTF | C HEX | L | FLOW DIA. D |
|--------------|--------------|------------------|-------|------|-------------|
| 66PLP-2-2 | 1/8 | 1/8 | 9/16 | 1.17 | .094 |
| 66PLP-2-4 | 1/8 | 1/4 | 11/16 | 1.34 | .094 |
| 66PLP-3-2 | 3/16 | 1/8 | 9/16 | 1.13 | .156 |
| 66PLP-5/32-2 | 5/32 | 1/8 | 9/16 | 1.17 | .125 |
| 66PLP-5/32-4 | 5/32 | 1/4 | 11/16 | 1.38 | .125 |
| 66PLP-4-2 | 1/4 | 1/8 | 9/16 | 1.17 | .188 |
| 66PLP-4-4 | 1/4 | 1/4 | 11/16 | 1.38 | .188 |
| 66PLP-5-2 | 5/16 | 1/8 | 9/16 | 1.25 | .250 |
| 66PLP-5-4 | 5/16 | 1/4 | 11/16 | 1.45 | .250 |
| 66PLP-6-4 | 3/8 | 1/4 | 11/16 | 1.46 | .312 |
| 66PLP-6-6 | 3/8 | 3/8 | 13/16 | 1.51 | .312 |

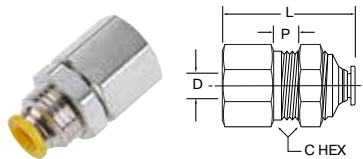

66PLPBH Female Bulkhead – BSPP

| PART NO. | TUBE SIZE MM | THREAD BSPP | C HEX | P MAX. | L MM | FLOW DIA. D | BKHD HOLE DIA. |
|----------------|--------------|-------------|-------|--------|-------|-------------|----------------|
| 66PLPBH-4M-4G | 4 | 1/4 | 11/16 | 3.81 | 37.85 | 3.175 | 12 |
| 66PLPBH-6M-4G | 6 | 1/4 | 11/16 | 3.91 | 36.40 | 4.775 | 14 |
| 66PLPBH-10M-6G | 10 | 3/8 | 1 | 4.93 | 39.50 | 7.925 | 22 |
| 66PLPBH-12M-6G | 12 | 3/8 | 1 | 7.62 | 41.61 | 9.525 | 22 |

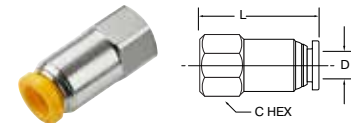

66PLP Female Connector – BSPP

| PART NO. | TUBE SIZE MM | THREAD BSPP | C HEX | L MM | FLOW DIA. D |
|--------------|--------------|-------------|-------|-------|-------------|
| 66PLP-4M-2G | 4 | 1/8 | 9/16 | 30.99 | 3.175 |
| 66PLP-4M-4G | 4 | 1/4 | 11/16 | 38.61 | 3.175 |
| 66PLP-6M-2G | 6 | 1/8 | 9/16 | 30.05 | 4.775 |
| 66PLP-6M-4G | 6 | 1/4 | 11/16 | 36.40 | 4.775 |
| 66PLP-8M-2G | 8 | 1/8 | 9/16 | 33.60 | 6.350 |
| 66PLP-8M-4G | 8 | 1/4 | 11/16 | 40.46 | 6.350 |
| 66PLP-10M-4G | 10 | 1/4 | 11/16 | 38.23 | 7.925 |
| 66PLP-10M-6G | 10 | 3/8 | 13/16 | 39.50 | 7.925 |

WARNING These products can expose you to chemicals including LEAD which is known to the state of California to cause cancer and birth defects or other reproductive harm. For more information go to www.P65Warnings.ca.gov.

[Click here for CADs, Product Specifications or to Configure Parts Online](#)

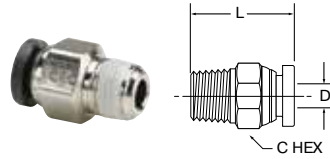

W68PLP Male Connector – NPTF

| PART NO. | TUBE SIZE IN | PIPE THD NPTF | C HEX | L | FLOW DIA. D |
|-----------------|--------------|---------------|-------|------|-------------|
| 68PLP-2-0** | 1/8 | 10X32 | 3/8 | .92 | .094 |
| W68PLP-2-1 | 1/8 | 1/16 | 3/8 | .79 | .094 |
| W68PLP-2-2 | 1/8 | 1/8 | 7/16 | .79 | .094 |
| W68PLP-2-4 | 1/8 | 1/4 | 9/16 | 1.02 | .094 |
| W68PLP-3-2 | 3/16 | 1/8 | 7/16 | .85 | .156 |
| W68PLP-3-4 | 3/16 | 1/4 | 9/16 | 1.01 | .156 |
| 68PLP-5/32-0** | 5/32 | 10X32 | 3/8 | .90 | .090 |
| W68PLP-5/32-1 | 5/32 | 1/16 | 3/8 | .88 | .940 |
| W68PLP-5/32-2 | 5/32 | 1/8 | 7/16 | .80 | .125 |
| W68PLP-5/32-4 | 5/32 | 1/4 | 9/16 | 1.03 | .125 |
| 68PLP-4-0** | 1/4 | 10X32 | 1/2 | .96 | .094 |
| W68PLP-4-1 | 1/4 | 1/16 | 1/2 | 1.07 | .141 |
| W68PLP-4-2 | 1/4 | 1/8 | 1/2 | .89 | .188 |
| W68PLP-4-4 | 1/4 | 1/4 | 9/16 | 1.00 | .188 |
| W68PLP-4-6 | 1/4 | 3/8 | 3/4 | 1.04 | .188 |
| W68PLP-5-2 | 5/16 | 1/8 | 9/16 | 1.18 | .250 |
| W68PLP-5-4 | 5/16 | 1/4 | 9/16 | 1.04 | .250 |
| W68PLP-5-6 | 5/16 | 3/8 | 11/16 | 1.04 | .250 |
| W68PLP-6-2 | 3/8 | 1/8 | 5/8 | 1.21 | .250 |
| W68PLP-6-4 | 3/8 | 1/4 | 5/8 | 1.08 | .312 |
| W68PLP-6-6 | 3/8 | 3/8 | 11/16 | 1.02 | .312 |
| W68PLP-6-8 | 3/8 | 1/2 | 7/8 | 1.28 | .312 |
| W68PLP-8-4 | 1/2 | 1/4 | 13/16 | 1.44 | .344 |
| W68PLP-8-6 | 1/2 | 3/8 | 13/16 | 1.24 | .344 |
| W68PLP-8-8 | 1/2 | 1/2 | 7/8 | 1.35 | .375 |
| 68PLP-5/32-4LT* | 5/32 | 1/4-28 | 7/16 | .88 | .093 |

* SAE-LTThreads
 ** Neoprene Seal

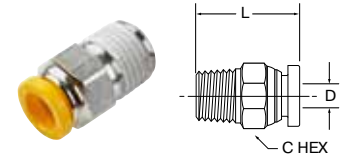

W68PLP Male Connector – BSPT

| PART NO. | TUBE SIZE MM | THREAD BSPT | C HEX | L MM | FLOW DIA. D |
|---------------|--------------|-------------|-------|-------|-------------|
| W68PLP-4M-2R | 4 | 1/8 | 7/16 | 20.41 | 3.175 |
| W68PLP-4M-4R | 4 | 1/4 | 9/16 | 27.18 | 3.175 |
| W68PLP-6M-2R | 6 | 1/8 | 1/2 | 22.00 | 4.775 |
| W68PLP-6M-4R | 6 | 1/4 | 9/16 | 26.74 | 4.775 |
| W68PLP-6M-6R | 6 | 3/8 | 11/16 | 26.46 | 4.775 |
| W68PLP-8M-2R | 8 | 1/8 | 9/16 | 29.80 | 6.350 |
| W68PLP-8M-4R | 8 | 1/4 | 9/16 | 26.24 | 6.350 |
| W68PLP-8M-6R | 8 | 3/8 | 11/16 | 27.51 | 6.350 |
| W68PLP-10M-4R | 10 | 1/4 | 5/8 | 29.72 | 7.925 |
| W68PLP-10M-6R | 10 | 3/8 | 11/16 | 27.18 | 7.925 |
| W68PLP-10M-8R | 10 | 1/2 | 7/8 | 34.24 | 7.925 |
| W68PLP-12M-4R | 12 | 1/4 | 13/16 | 36.90 | 8.738 |
| W68PLP-12M-6R | 12 | 3/8 | 13/16 | 30.85 | 9.525 |
| W68PLP-12M-8R | 12 | 1/2 | 7/8 | 33.85 | 9.525 |

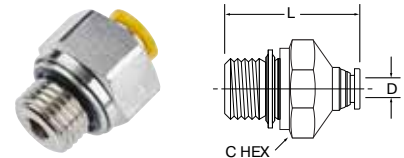

68PLP Male Connector – BSPP

| PART NO. | TUBE SIZE MM | THREAD BSPP | C HEX | L MM | FLOW DIA. D |
|--------------|--------------|-------------|--------|-------|-------------|
| 68PLP-4M-M5 | 4 | M5X0.8 | 3/8 | 21.15 | 2.693 |
| 68PLP-4M-2G | 4 | 1/8 | 9/16 | 23.22 | 3.175 |
| 68PLP-4M-4G | 4 | 1/4 | 3/4 | 29.32 | 3.175 |
| 68PLP-6M-M5* | 6 | M5X0.8 | 1/2 | 23.39 | 2.80 |
| 68PLP-6M-2G | 6 | 1/8 | 9/16 | 22.00 | 4.775 |
| 68PLP-6M-4G | 6 | 1/4 | 3/4 | 28.10 | 4.775 |
| 68PLP-6M-6G | 6 | 3/8 | 7/8 | 31.90 | 4.775 |
| 68PLP-8M-2G | 8 | 1/8 | 9/16 | 29.67 | 6.350 |
| 68PLP-8M-4G | 8 | 1/4 | 3/4 | 30.05 | 6.350 |
| 68PLP-8M-6G | 8 | 3/8 | 7/8 | 35.14 | 6.350 |
| 68PLP-10M-4G | 10 | 1/4 | 3/4 | 31.88 | 7.925 |
| 68PLP-10M-6G | 10 | 3/8 | 7/8 | 26.80 | 7.925 |
| 68PLP-10M-8G | 10 | 1/2 | 1 1/16 | 31.88 | 7.925 |
| 68PLP-12M-4G | 12 | 1/4 | 13/16 | 35.76 | 8.738 |
| 68PLP-12M-6G | 12 | 3/8 | 7/8 | 33.22 | 9.525 |
| 68PLP-12M-8G | 12 | 1/2 | 1 1/16 | 33.47 | 9.525 |

*M5 seal is neoprene

WARNING These products can expose you to chemicals including LEAD which is known to the state of California to cause cancer and birth defects or other reproductive harm. For more information go to www.P65Warnings.ca.gov.



Click here for CADs, Product Specifications or to Configure Parts Online

- A
- B
- C
- D
- E
- F
- G
- H
- I
- J
- K
- L
- M
- N
- O



68PLP Male Connector – BSPP

| PART NO. | TUBE SIZE IN | PIPE THD BSPP | C HEX | L | FLOW DIA. D |
|------------|--------------|---------------|--------|------|-------------|
| 68PLP-4-2G | 1/4 | 1/8 | 11/16 | 1.13 | .188 |
| 68PLP-4-4G | 1/4 | 1/4 | 3/4 | 1.13 | .188 |
| 68PLP-4-6G | 1/4 | 3/8 | 7/8 | 1.08 | .188 |
| 68PLP-6-4G | 3/8 | 1/4 | 3/4 | 1.26 | .31 |
| 68PLP-6-6G | 3/8 | 3/8 | 3/4 | 1.26 | .31 |
| 68PLP-6-8G | 3/8 | 1/2 | 7/8 | 1.26 | .31 |
| 68PLP-8-6G | 1/2 | 3/8 | 7/8 | 1.36 | .45 |
| 68PLP-8-8G | 1/2 | 1/2 | 1-1/16 | 1.36 | .45 |

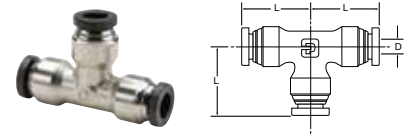

164PLP Union Tee – Inch

| PART NO. | TUBE SIZE IN | L | FLOW DIA. D |
|-------------|--------------|------|-------------|
| 164PLP-2 | 1/8 | .74 | .094 |
| 164PLP-3 | 3/16 | .82 | .156 |
| 164PLP-5/32 | 5/32 | .77 | .125 |
| 164PLP-4 | 1/4 | .85 | .188 |
| 164PLP-5 | 5/16 | .97 | .250 |
| 164PLP-6 | 3/8 | 1.01 | .250 |
| 164PLP-8 | 1/2 | 1.15 | .375 |

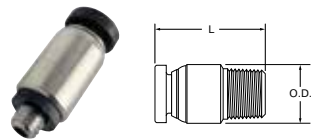

68PLPR Round Male Connector – NPTF/UNF

| PART NO. | TUBE SIZE IN | THREAD SIZE NPTF | INTERNAL HEX BROACH | BODY DIA. O.D. | L | FLOW DIA. |
|----------------|--------------|------------------|---------------------|----------------|------|-----------|
| 68PLPR-2-0* | 1/8 | 10-32 | 3/32 | 3/8" | .89 | .094 |
| 68PLPR-5/32-0* | 5/32 | 10-32 | 3/32 | 3/8" | .91 | .094 |
| 68PLPR-4-0* | 1/4 | 10-32 | 3/32 | 1/2" | .95 | .094 |
| W68PLPR-5/32-1 | 5/32 | 1/16 | 1/8 | 3/8" | .87 | .125 |
| W68PLPR-5/32-2 | 5/32 | 1/8 | 1/8 | 7/16" | .79 | .125 |
| W68PLPR-4-1 | 1/4 | 1/16 | 5/32 | 1/2" | 1.06 | .156 |
| W68PLPR-4-2 | 1/4 | 1/8 | 3/16 | 1/2" | .88 | .188 |
| W68PLPR-4-4 | 1/4 | 1/4 | 3/16 | 5/8" | .99 | .188 |

*10-32 seal is neoprene

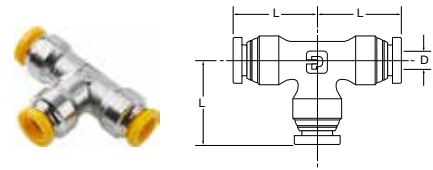

164PLP Union Tee – Metric

| PART NO. | TUBE SIZE MM | L MM | FLOW DIA. D |
|------------|--------------|-------|-------------|
| 164PLP-4M | 4 | 19.40 | 3.175 |
| 164PLP-6M | 6 | 20.47 | 4.775 |
| 164PLP-8M | 8 | 24.58 | 6.350 |
| 164PLP-10M | 10 | 24.90 | 7.137 |
| 164PLP-12M | 12 | 28.77 | 9.525 |

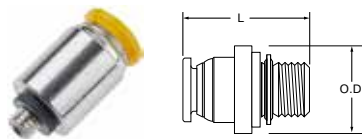

Round Male Connector – BSPP/M5

| PART NO. | TUBE SIZE MM | THREAD BSPP/M5 | INTERNAL HEX BROACH | BODY DIA. O.D. | L MM | FLOW DIA. |
|---------------|--------------|----------------|---------------------|----------------|-------|-----------|
| 68PLPR-4M-M5 | 4 | M5X0.8 | 2.43 | 10.74 | 23.13 | 2.801 |
| 68PLPR-4M-2G | 4 | 1/8 | 3.07 | 10.74 | 23.10 | 3.549 |
| 68PLPR-6M-M5* | 6 | M5X0.8 | 2.46 | 11.94 | 23.91 | 2.801 |
| 68PLPR-6M-2G | 6 | 1/8 | 4.85 | 11.94 | 22.13 | 5.602 |
| 68PLPR-6M-4G | 6 | 1/4 | 4.85 | 11.94 | 26.95 | 5.602 |

*M5 seal is neoprene

WARNING These products can expose you to chemicals including LEAD which is known to the state of California to cause cancer and birth defects or other reproductive harm. For more information go to www.P65Warnings.ca.gov.

[Click here for CADs, Product Specifications or to Configure Parts Online](#)

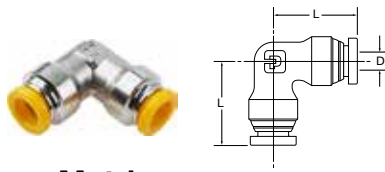

165PLP Union Elbow – Metric

| PART NO. | TUBE SIZE MM | L MM | FLOW DIA. D |
|------------|--------------|-------|-------------|
| 165PLP-4M | 4 | 19.05 | 3.175 |
| 165PLP-6M | 6 | 20.14 | 4.775 |
| 165PLP-8M | 8 | 24.21 | 6.350 |
| 165PLP-10M | 10 | 23.75 | 7.925 |
| 165PLP-12M | 12 | 27.13 | 9.525 |

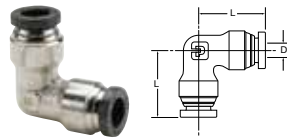

W169PLP Male Elbow Swivel 90° – NPTF

| PART NO. | TUBE SIZE IN | PIPE THREAD NPTF | C HEX | L | N | FLOW DIA. D |
|----------------|--------------|------------------|-------|------|------|-------------|
| W169PLP-2-1 | 1/8 | 1/16 | 3/8 | .74 | .93 | .160 |
| W169PLP-2-2 | 1/8 | 1/8 | 7/16 | .74 | .92 | .094 |
| 169PLP-2-0* | 1/8 | 10-32 | 3/8 | .74 | .74 | .080 |
| W169PLP-2-4 | 1/8 | 1/4 | 9/16 | .74 | 1.10 | .094 |
| W169PLP-3-2 | 3/16 | 1/8 | 7/16 | .82 | .92 | .156 |
| W169PLP-5/32-1 | 5/32 | 1/16 | 3/8 | .84 | .93 | .160 |
| W169PLP-5/32-2 | 5/32 | 1/8 | 7/16 | .77 | .92 | .125 |
| W169PLP-5/32-4 | 5/32 | 1/4 | 9/16 | .77 | 1.10 | .125 |
| 169PLP-5/32-0* | 5/32 | 10-32 | 3/8 | .85 | .74 | .080 |
| W169PLP-4-1 | 1/4 | 1/16 | 3/8 | .84 | .93 | .160 |
| W169PLP-4-2 | 1/4 | 1/8 | 7/16 | .85 | .92 | .156 |
| W169PLP-4-4 | 1/4 | 1/4 | 9/16 | .85 | 1.10 | .156 |
| W169PLP-4-6 | 1/4 | 3/8 | 11/16 | .85 | 1.19 | .156 |
| 169PLP-4-0* | 1/4 | 10-32 | 3/8 | .85 | .74 | .080 |
| W169PLP-5-2 | 5/16 | 1/8 | 9/16 | .97 | 1.02 | .250 |
| W169PLP-5-4 | 5/16 | 1/4 | 9/16 | .97 | 1.24 | .250 |
| W169PLP-6-2 | 3/8 | 1/8 | 9/16 | 1.01 | 1.02 | .250 |
| W169PLP-6-4 | 3/8 | 1/4 | 9/16 | 1.01 | 1.24 | .250 |
| W169PLP-6-6 | 3/8 | 3/8 | 11/16 | 1.01 | 1.24 | .250 |
| W169PLP-6-8 | 3/8 | 1/2 | 7/8 | 1.01 | 1.48 | .250 |
| W169PLP-8-4 | 1/2 | 1/4 | 9/16 | 1.15 | 1.28 | .312 |
| W169PLP-8-6 | 1/2 | 3/8 | 11/16 | 1.15 | 1.31 | .312 |
| W169PLP-8-8 | 1/2 | 1/2 | 7/8 | 1.15 | 1.52 | .312 |

*10-32 seal is neoprene

165PLP Union Elbow – Inch

| PART NO. | TUBE SIZE IN | L | FLOW DIA. D |
|-------------|--------------|------|-------------|
| 165PLP-2 | 1/8 | .74 | .094 |
| 165PLP-5/32 | 5/32 | .77 | .125 |
| 165PLP-4 | 1/4 | .85 | .188 |
| 165PLP-5 | 5/16 | .97 | .250 |
| 165PLP-6 | 3/8 | 1.01 | .312 |
| 165PLP-8 | 1/2 | 1.15 | .375 |

WARNING These products can expose you to chemicals including LEAD which is known to the state of California to cause cancer and birth defects or other reproductive harm. For more information go to www.P65Warnings.ca.gov.



Click here for CADs, Product Specifications or to Configure Parts Online

- A
- B
- C
- D
- E
- F
- G
- H
- I
- J
- K
- L
- M
- N
- O

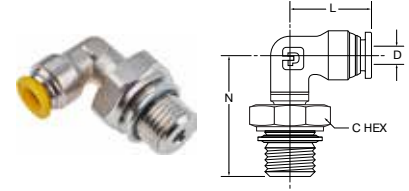
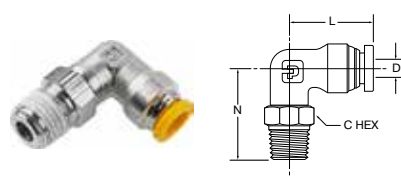

W169PLP Male Elbow Swivel 90° – BSPT

| PART NO. | TUBE SIZE MM | THREAD BSPT | C HEX | L MM | N MM | FLOW DIA. D |
|----------------|--------------|-------------|-------|-------|-------|-------------|
| W169PLP-4M-2R | 4 | 1/8 | 7/16 | 19.05 | 23.93 | 3.175 |
| W169PLP-4M-4R | 4 | 1/4 | 9/16 | 19.05 | 28.50 | 3.962 |
| W169PLP-6M-2R | 6 | 1/8 | 7/16 | 19.13 | 22.91 | 3.962 |
| W169PLP-6M-4R | 6 | 1/4 | 9/16 | 19.13 | 27.48 | 3.962 |
| W169PLP-6M-6R | 6 | 3/8 | 11/16 | 19.13 | 29.74 | 3.962 |
| W169PLP-8M-2R | 8 | 1/8 | 9/16 | 24.20 | 26.16 | 6.350 |
| W169PLP-8M-4R | 8 | 1/4 | 9/16 | 24.20 | 31.75 | 6.350 |
| W169PLP-8M-6R | 8 | 3/8 | 9/16 | 24.20 | 31.75 | 6.350 |
| W169PLP-10M-4R | 10 | 1/4 | 9/16 | 23.75 | 31.49 | 6.350 |
| W169PLP-10M-6R | 20 | 3/8 | 11/16 | 23.75 | 31.75 | 6.350 |
| W169PLP-10M-8R | 10 | 1/2 | 7/8 | 23.75 | 37.69 | 6.350 |
| W169PLP-12M-4R | 12 | 1/4 | 11/16 | 27.63 | 32.86 | 7.950 |
| W169PLP-12M-6R | 12 | 3/8 | 11/16 | 27.63 | 33.78 | 9.525 |
| W169PLP-12M-8R | 12 | 1/2 | 7/8 | 27.63 | 38.96 | 9.525 |

169PLP Male Elbow Swivel 90° – BSPP

| PART NO. | TUBE SIZE MM | THREAD BSPP | C HEX | L MM | N MM | FLOW DIA. D |
|---------------|--------------|-------------|--------|-------|-------|-------------|
| 169PLP-4M-M5 | 4 | M5X0.8 | 3/8 | 19.05 | 19.79 | 2.425 |
| 169PLP-4M-2G | 4 | 1/8 | 9/16 | 19.05 | 23.92 | 3.175 |
| 169PLP-4M-4G | 4 | 1/4 | 3/4 | 19.05 | 30.27 | 3.175 |
| 169PLP-6M-M5* | 6 | M5X0.8 | 3/8 | 19.12 | 18.52 | 2.425 |
| 169PLP-6M-2G | 6 | 1/8 | 9/16 | 19.12 | 22.94 | 3.960 |
| 169PLP-6M-4G | 6 | 1/4 | 3/4 | 19.12 | 29.23 | 3.960 |
| 169PLP-6M-6G | 6 | 3/8 | 11/16 | 19.12 | 31.04 | 2.425 |
| 169PLP-8M-2G | 8 | 1/8 | 9/16 | 24.25 | 27.13 | 6.350 |
| 169PLP-8M-4G | 8 | 1/4 | 3/4 | 24.20 | 33.25 | 6.350 |
| 169PLP-8M-6G | 8 | 3/8 | 11/16 | 24.25 | 33.22 | 6.350 |
| 169PLP-10M-4G | 10 | 1/4 | 3/4 | 23.75 | 32.77 | 6.350 |
| 169PLP-10M-6G | 10 | 3/8 | 11/16 | 23.75 | 32.61 | 6.350 |
| 169PLP-10M-8G | 10 | 1/2 | 1 1/16 | 23.75 | 37.59 | 6.350 |
| 169PLP-12M-4G | 12 | 1/4 | 3/4 | 26.63 | 35.20 | 7.950 |
| 169PLP-12M-6G | 12 | 3/8 | 7/8 | 26.63 | 53.20 | 9.525 |
| 169PLP-12M-8G | 12 | 1/2 | 1 1/16 | 26.63 | 38.96 | 9.525 |

*M5 seal is neoprene

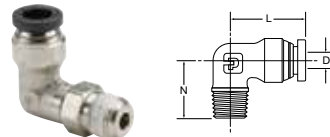

W169PLPNS Male Elbow 90° – NPTF

| PART NO. | TUBE IN | PIPE THD NPTF | L | N | FLOW DIA. D |
|-------------------|---------|---------------|------|------|-------------|
| W169PLPNS-2-2 | 1/8 | 1/8 | .74 | .67 | .094 |
| W169PLPNS5/32-2 | 5/32 | 1/8 | .77 | .67 | .125 |
| W169PLPNS5/32-4 | 5/32 | 1/4 | .77 | .87 | .125 |
| W169PLPNS-4-2 | 1/4 | 1/8 | .85 | .67 | .188 |
| W169PLPNS-4-4 | 1/4 | 1/4 | .85 | .87 | .188 |
| W169PLPNS-5-2 | 5/16 | 1/8 | .97 | .75 | .234 |
| W169PLPNS-5-4 | 5/16 | 1/4 | .97 | .94 | .250 |
| W169PLPNS-6-4 | 3/8 | 1/4 | 1.01 | .94 | .312 |
| W169PLPNS-6-6 | 3/8 | 3/8 | 1.01 | 1.01 | .312 |
| W169PLPNS-6-8 | 3/8 | 1/2 | 1.01 | 1.27 | .312 |
| W169PLPNS-8-6 | 1/2 | 3/8 | 1.15 | 1.00 | .375 |
| W169PLPNS-8-8 | 1/2 | 1/2 | 1.15 | 1.27 | .375 |
| 169PLPNS-5/32-4LT | 5/32 | 1/4-28 | .60 | .48 | .090 |

* SAE-LT Threads

WARNING These products can expose you to chemicals including LEAD which is known to the state of California to cause cancer and birth defects or other reproductive harm. For more information go to www.P65Warnings.ca.gov.

[Click here for CADs, Product Specifications or to Configure Parts Online](#)

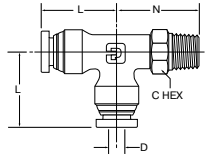

W171PLP Male Run Tee Swivel – NPTF

| PART NO. | TUBE SIZE IN | PIPE THREAD NPTF | C HEX | L | N | FLOW DIA. D |
|----------------|--------------|------------------|-------|------|------|-------------|
| W171PLP-2-2 | 1/8 | 1/8 | 7/16 | .74 | .92 | .094 |
| W171PLP-5/32-2 | 5/32 | 1/8 | 7/16 | .77 | .92 | .125 |
| W171PLP-4-2 | 1/4 | 1/8 | 7/16 | .85 | .92 | .156 |
| W171PLP-4-4 | 1/4 | 1/4 | 9/16 | .85 | 1.10 | .156 |
| W171PLP-4-6 | 1/4 | 3/8 | 11/16 | .85 | 1.24 | .156 |
| W171PLP-5-2 | 5/16 | 1/8 | 9/16 | .97 | 1.02 | .250 |
| W171PLP-5-4 | 5/16 | 1/4 | 9/16 | .97 | 1.24 | .250 |
| W171PLP-6-4 | 3/8 | 1/4 | 9/16 | 1.01 | 1.24 | .250 |
| W171PLP-6-6 | 3/8 | 3/8 | 11/16 | 1.01 | 1.24 | .250 |
| W171PLP-8-6 | 1/2 | 3/8 | 11/16 | 1.15 | 1.31 | .312 |
| W171PLP-8-8 | 1/2 | 1/2 | 7/8 | 1.15 | 1.52 | .312 |

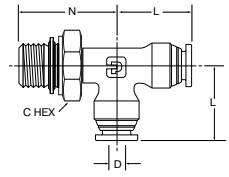

171PLP Male Run Tee Swivel – BSPP

| PART NO. | TUBE SIZE MM | THREAD BSPP | C HEX | L MM | N MM | FLOW DIA. D |
|---------------|--------------|-------------|--------|-------|-------|-------------|
| 171PLP-4M-2G | 4 | 1/8 | 9/16 | 19.05 | 24.02 | 3.17 |
| 171PLP-4M-4G | 4 | 1/4 | 3/4 | 19.05 | 30.37 | 3.17 |
| 171PLP-6M-2G | 6 | 1/8 | 9/16 | 20.90 | 23.92 | 4.77 |
| 171PLP-6M-4G | 6 | 1/4 | 3/4 | 20.90 | 30.27 | 4.77 |
| 171PLP-6M-6G | 6 | 3/8 | 7/8 | 20.90 | 32.30 | 4.77 |
| 171PLP-8M-2G | 8 | 1/8 | 9/16 | 24.40 | 26.92 | 6.35 |
| 171PLP-8M-4G | 8 | 1/4 | 3/4 | 24.20 | 33.02 | 6.35 |
| 171PLP-8M-6G | 8 | 3/8 | 7/8 | 24.20 | 33.02 | 6.35 |
| 171PLP-10M-4G | 10 | 1/4 | 3/4 | 25.52 | 33.02 | 7.13 |
| 171PLP-10M-6G | 10 | 3/8 | 7/8 | 25.52 | 33.02 | 7.13 |
| 171PLP-10M-8G | 10 | 1/2 | 1 1/16 | 25.52 | 37.84 | 7.13 |
| 171PLP-12M-4G | 12 | 1/4 | 3/4 | 29.15 | 35.30 | 9.52 |
| 171PLP-12M-6G | 12 | 3/8 | 7/8 | 29.15 | 35.30 | 9.52 |
| 171PLP-12M-8G | 12 | 1/2 | 1 1/16 | 29.15 | 38.86 | 9.52 |

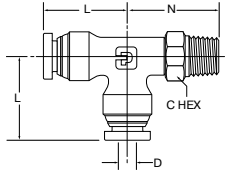

W171PLP Male Run Tee Swivel – BSPT

| PART NO. | TUBE SIZE MM | THREAD BSPT | C HEX | L MM | N MM | FLOW DIA. D |
|----------------|--------------|-------------|-------|-------|-------|-------------|
| W171PLP-4M-2R | 4 | 1/8 | 7/16 | 19.05 | 23.95 | 3.17 |
| W171PLP-4M-4R | 4 | 1/4 | 9/16 | 19.05 | 28.60 | 3.17 |
| W171PLP-6M-2R | 6 | 1/8 | 7/16 | 20.90 | 23.92 | 4.77 |
| W171PLP-6M-4R | 6 | 1/4 | 9/16 | 20.90 | 28.49 | 4.77 |
| W171PLP-6M-6R | 6 | 3/8 | 11/16 | 20.90 | 30.78 | 4.77 |
| W171PLP-8M-2R | 8 | 1/8 | 9/16 | 24.20 | 26.16 | 6.35 |
| W171PLP-8M-4R | 8 | 1/4 | 9/16 | 24.20 | 31.75 | 6.35 |
| W171PLP-8M-6R | 8 | 3/8 | 11/16 | 24.20 | 31.75 | 6.35 |
| W171PLP-10M-4R | 10 | 1/4 | 9/16 | 25.52 | 31.75 | 7.13 |
| W171PLP-10M-6R | 10 | 3/8 | 11/16 | 25.52 | 31.75 | 7.13 |
| W171PLP-10M-8R | 10 | 1/2 | 7/8 | 25.52 | 37.84 | 7.13 |
| W171PLP-12M-4R | 12 | 1/4 | 11/16 | 29.15 | 32.77 | 9.52 |
| W171PLP-12M-6R | 12 | 3/8 | 11/16 | 29.15 | 33.52 | 9.52 |
| W171PLP-12M-8R | 12 | 1/2 | 7/8 | 29.15 | 38.86 | 9.52 |

WARNING These products can expose you to chemicals including LEAD which is known to the state of California to cause cancer and birth defects or other reproductive harm. For more information go to www.P65Warnings.ca.gov.



- A
- B
- C
- D
- E
- F
- G
- H
- I
- J
- K
- L
- M
- N
- O

[Click here for CADs, Product Specifications or to Configure Parts Online](#)

- A
- B
- C
- D
- E
- F
- G
- H
- I
- J
- K
- L
- M
- N
- O

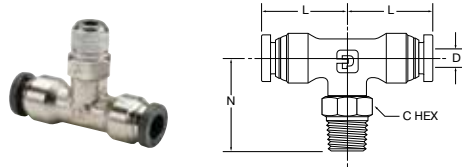

W172PLP Male Branch Tee Swivel – NPTF

| PART NO. | TUBE SIZE IN | PIPE THREAD NPTF | C HEX | L | N | FLOW DIA. D |
|----------------|--------------|------------------|-------|------|------|-------------|
| W172PLP-2-2 | 1/8 | 1/8 | 7/16 | .74 | .92 | .094 |
| W172PLP-3-2 | 3/16 | 1/8 | 7/16 | .82 | .92 | .156 |
| W172PLP-5/32-2 | 5/32 | 1/8 | 7/16 | .77 | .92 | .125 |
| 172PLP-4-0 | 1/4 | 10-32 | 3/8 | .84 | .80 | .250 |
| W172PLP-4-2 | 1/4 | 1/8 | 7/16 | .85 | .92 | .156 |
| W172PLP-4-4 | 1/4 | 1/4 | 9/16 | .85 | 1.10 | .156 |
| W172PLP-4-6 | 1/4 | 3/8 | 11/16 | .85 | 1.10 | .156 |
| W172PLP-5-2 | 5/16 | 1/8 | 9/16 | .97 | 1.02 | .250 |
| W172PLP-5-4 | 5/16 | 1/4 | 9/16 | .97 | 1.24 | .250 |
| W172PLP-6-4 | 3/8 | 1/4 | 9/16 | 1.01 | 1.24 | .250 |
| W172PLP-6-6 | 3/8 | 3/8 | 11/16 | 1.01 | 1.24 | .250 |
| W172PLP-6-8 | 3/8 | 1/2 | 7/8 | 1.00 | 1.48 | .250 |
| W172PLP-8-4 | 1/2 | 1/4 | 9/16 | 1.15 | 1.30 | .312 |
| W172PLP-8-6 | 1/2 | 3/8 | 11/16 | 1.15 | 1.31 | .312 |
| W172PLP-8-8 | 1/2 | 1/2 | 7/8 | 1.15 | 1.52 | .312 |

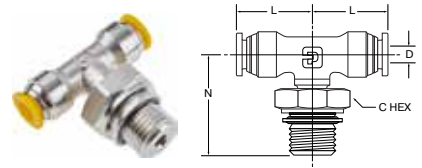

172PLP Male Branch Tee Swivel – BSPP

| PART NO. | TUBE SIZE MM | THREAD BSPP | C HEX | L MM | N MM | FLOW DIA. D |
|---------------|--------------|-------------|--------|-------|-------|-------------|
| 172PLP-4M-2G | 4 | 1/8 | 9/16 | 19.05 | 24.35 | 3.17 |
| 172PLP-4M-4G | 4 | 1/4 | 3/4 | 19.05 | 30.70 | 3.17 |
| 172PLP-6M-2G | 6 | 1/8 | 9/16 | 21.15 | 23.92 | 3.96 |
| 172PLP-6M-4G | 6 | 1/4 | 3/4 | 21.15 | 30.27 | 3.96 |
| 172PLP-6M-6G | 6 | 3/8 | 7/8 | 21.15 | 32.30 | 3.96 |
| 172PLP-8M-2G | 8 | 1/8 | 9/16 | 24.20 | 27.33 | 6.35 |
| 172PLP-8M-4G | 8 | 1/4 | 3/4 | 24.20 | 33.42 | 6.35 |
| 172PLP-8M-6G | 8 | 3/8 | 7/8 | 24.20 | 33.42 | 6.35 |
| 172PLP-10M-4G | 10 | 1/4 | 3/4 | 25.52 | 33.42 | 6.35 |
| 172PLP-10M-6G | 10 | 3/8 | 7/8 | 25.52 | 33.42 | 6.35 |
| 172PLP-10M-8G | 10 | 1/2 | 1 1/16 | 25.52 | 38.25 | 6.35 |
| 172PLP-12M-4G | 12 | 1/4 | 3/4 | 28.65 | 35.56 | 7.95 |
| 172PLP-12M-6G | 12 | 3/8 | 7/8 | 28.65 | 35.56 | 9.52 |
| 172PLP-12M-8G | 12 | 1/2 | 1 1/16 | 28.65 | 39.11 | 9.52 |

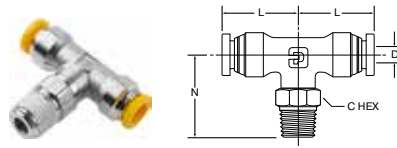

W172PLP Male Branch Tee Swivel – BSPT

| PART NO. | TUBE SIZE MM | THREAD BSPT | C HEX | L MM | N MM | FLOW DIA. D |
|----------------|--------------|-------------|-------|-------|-------|-------------|
| W172PLP-4M-2R | 4 | 1/8 | 7/16 | 19.05 | 24.35 | 3.17 |
| W172PLP-4M-4R | 4 | 1/4 | 9/16 | 19.05 | 28.93 | 3.17 |
| W172PLP-6M-2R | 6 | 1/8 | 7/16 | 21.15 | 23.92 | 3.96 |
| W172PLP-6M-4R | 6 | 1/4 | 9/16 | 21.15 | 28.49 | 3.96 |
| W172PLP-6M-6R | 6 | 3/8 | 11/16 | 21.15 | 30.78 | 3.96 |
| W172PLP-8M-2R | 8 | 1/8 | 9/16 | 24.20 | 26.56 | 6.35 |
| W172PLP-8M-4R | 8 | 1/4 | 9/16 | 24.20 | 32.15 | 6.35 |
| W172PLP-8M-6R | 8 | 3/8 | 11/16 | 24.20 | 32.15 | 6.35 |
| W172PLP-10M-4R | 10 | 1/4 | 9/16 | 25.53 | 32.14 | 7.14 |
| W172PLP-10M-6R | 10 | 3/8 | 11/16 | 25.53 | 32.14 | 7.14 |
| W172PLP-10M-8R | 10 | 1/2 | 7/8 | 25.53 | 32.24 | 7.14 |
| W172PLP-12M-4R | 12 | 1/4 | 9/16 | 28.65 | 33.02 | 9.53 |
| W172PLP-12M-6R | 12 | 3/8 | 11/16 | 28.65 | 33.78 | 9.53 |
| W172PLP-12M-8R | 12 | 1/2 | 7/8 | 28.65 | 39.11 | 9.53 |

WARNING These products can expose you to chemicals including LEAD which is known to the state of California to cause cancer and birth defects or other reproductive harm. For more information go to www.P65Warnings.ca.gov.

[Click here for CADs, Product Specifications or to Configure Parts Online](#)

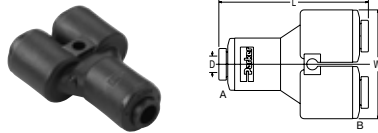

362PW – Union Y (PVDF) – Inch

| PART NO. | TUBE SIZE IN | TUBE SIZE IN | L IN | W IN | FLOW DIA. D |
|-----------|--------------|--------------|-------|------|-------------|
| 362PW-4 | 1/4 | 1/4 | 2.100 | 1.43 | 0.190 |
| 362PW-4-6 | 3/8 | 1/4 | 2.100 | 1.43 | 0.190 |
| 362PW-6 | 3/8 | 3/8 | 2.175 | 1.75 | 0.250 |
| 362PW-6-8 | 1/2 | 3/8 | 2.370 | 1.93 | 0.250 |
| 362PW-8 | 1/2 | 1/2 | 2.370 | 1.93 | 0.380 |

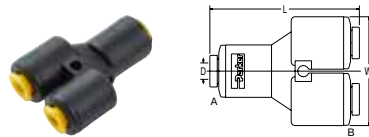

362PW – Union Y (PVDF) – Metric

| PART NO. | 1 TUBE SIZE MM | 2 TUBE SIZE MM | L MM | W MM | FLOW DIA. D |
|---------------|----------------|----------------|-------|-------|-------------|
| 362PW-6M | 6 | 6 | 53.34 | 51.94 | 0.190 |
| 362PW-6M-10M | 6 | 10 | 53.34 | 51.94 | 0.190 |
| 362PW-8M | 8 | 8 | 57.15 | 44.45 | 0.190 |
| 362PW-8M-12M | 8 | 12 | 60.20 | 49.02 | 0.250 |
| 362PW-10M | 10 | 10 | 60.20 | 49.02 | 0.250 |
| 362PW-10M-12M | 10 | 12 | 60.20 | 49.02 | 0.250 |
| 362PW-12M | 12 | 12 | 60.20 | 49.02 | 0.250 |

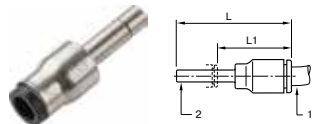

62PLPSP – Tube Expander – Inch

| PART NO. | 1 TUBE SIZE IN | 2 TUBE SIZE IN | L IN | L1 IN |
|----------------|----------------|----------------|------|-------|
| 62PLPSP-4-5/32 | 1/4 | 5/32 | 1.39 | .71 |
| 62PLPSP-6-4 | 3/8 | 1/4 | 1.66 | .89 |

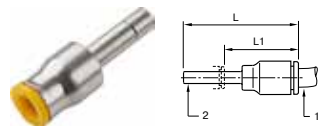

62PLPSP – Tube Expander – Metric

| PART NO. | 1 TUBE SIZE MM | 2 TUBE SIZE MM | L MM | L1 MM |
|-----------------|----------------|----------------|------|-------|
| 62PLPSP-10M-8M | 10 | 8 | 42.7 | 21.2 |
| 62PLPSP-12M-10M | 12 | 10 | 48.5 | 24 |
| 62PLPSP-6M-4M | 6 | 4 | 33 | 21 |
| 62PLPSP-8M-6M | 8 | 6 | 39.6 | 26.1 |

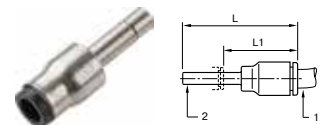

67PLP – Tube Reducer – Inch

| PART NO. | 1 TUBE SIZE IN | 2 TUBE SIZE IN | L IN | L1 IN |
|--------------|----------------|----------------|------|-------|
| 67PLP-5/32-4 | 5/32 | 1/4 | 1.46 | .81 |
| 67PLP-5/32-6 | 5/32 | 3/8 | 1.67 | 1.02 |
| 67PLP-5-6 | 5/16 | 3/8 | 1.83 | 1.06 |
| 67PLP-5-8 | 5/16 | 1/2 | 1.97 | 1.2 |
| 67PLP-4-6 | 1/4 | 3/8 | 1.75 | 1.07 |
| 67PLP-4-8 | 1/4 | 1/2 | 1.85 | 1.17 |
| 67PLP-6-8 | 3/8 | 1/2 | 1.97 | 1.2 |

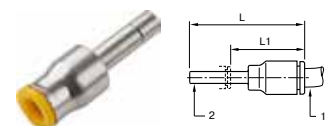

67PLP – Tube Reducer – Metric

| PART NO. | 1 TUBE SIZE MM | 2 TUBE SIZE MM. | L MM | L1 MM |
|---------------|----------------|-----------------|------|-------|
| 67PLP-10M-12M | 10 | 12 | 48.8 | 25.8 |
| 67PLP-4M-10M | 4 | 10 | 37.6 | 16.1 |
| 67PLP-4M-6M | 4 | 6 | 34.5 | 24.5 |
| 67PLP-4M-8M | 4 | 8 | 40.1 | 21.6 |
| 67PLP-6M-10M | 6 | 10 | 41.4 | 20.9 |
| 67PLP-6M-12M | 6 | 12 | 44.2 | 21.2 |
| 67PLP-6M-8M | 6 | 8 | 38.6 | 23.1 |
| 67PLP-8M-10M | 8 | 10 | 47 | 26.5 |
| 67PLP-8M-12M | 8 | 12 | 49.3 | 24.8 |

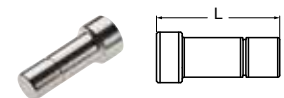

139PLP – Plug – Metric

| PART NO. | TUBE SIZE MM | L IN |
|------------|--------------|------|
| 139PLP-6M | 6 | .92 |
| 139PLP-8M | 5/16 (8mm) | 1.10 |
| 139PLP-10M | 10 | 1.22 |
| 139PLP-12M | 12 | 1.34 |

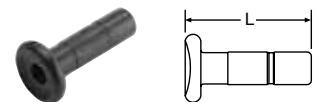

TPL – Plug (PVDF) – Inch

| PART NO. | TUBE SIZE IN | L IN |
|-----------|--------------|------|
| FB4TPL | 1/4 | .88 |
| 139PLP-8M | 5/16 | 1.10 |
| FB6TPL | 3/8 | 1.45 |
| FB8TPL | 1/2 | 1.50 |

WARNING These products can expose you to chemicals including LEAD which is known to the state of California to cause cancer and birth defects or other reproductive harm. For more information go to www.P65Warnings.ca.gov.



- A
- B
- C
- D
- E
- F
- G
- H
- I
- J
- K
- L
- M
- N
- O

[Click here for CADs, Product Specifications or to Configure Parts Online](#)

- A
- B
- C
- D
- E
- F
- G
- H
- I
- J
- K
- L
- M
- N
- O



DB – Dust/Weld Spatter Boot

| PART NO. | TUBE SIZE IN | L IN | D IN |
|----------|--------------|------|------|
| DB-4 | 1/4 (6MM) | .50 | .40 |
| DB-6 | 3/8 (10MM) | .50 | .63 |
| DB-8 | 1/2 (12MM) | .50 | .75 |



0139 Bi-Material Captive Sealing Washer BSPP

| PART NO. | C BSPP | G MM | G2 MM | K MM | WT. OZ |
|------------|--------|------|-------|------|--------|
| 0139 10 00 | G1/8 | 14 | 1 | 1.8 | .001 |
| 0139 13 00 | G1/4 | 17 | 1 | 1.8 | .001 |
| 0139 17 00 | G3/8 | 22 | 1.3 | 2.1 | .001 |
| 0139 21 00 | G1/2 | 26 | 1.6 | 2.4 | .002 |



Tube Cutter

| PART NO. | DESCRIPTION |
|---------------|---|
| 3000 71 11 | Tube cutter for tubing and push-on hose. for hoses up to 1" (25mm). Weight: 1.09oz. |
| 3000 71 11 05 | Replacement Blades |



Tube Cutter

| PART NO. | DESCRIPTION |
|-----------|---|
| PTC-001 | Plastic Tube Cutter – May be used with polyethylene, polypropylene, nylon, and other thermoplastic tubing. For tube O.D. sizes 1/8" to 1/2" |
| PTC-001RB | Replacement Blades |



Quick Release Tool

| PART NO. | DESCRIPTION |
|----------|--|
| AQRT | Quick release tool makes disconnection of tube adapters and tubing a breeze. |

WARNING These products can expose you to chemicals including LEAD which is known to the state of California to cause cancer and birth defects or other reproductive harm. For more information go to www.P65Warnings.ca.gov.



Prestolok PLP Composite Push-to-Connect Fittings

Prestolok push-to-connect composite fittings with its wide variety configurations allows you to find the perfect product to meet your needs, optimizing the use of your equipment.

Product Features:

- Stainless steel grab ring
- Glass-reinforced nylon 6.6 body
- Nitrile D-seal
- Nylon release button
- Corrosion and chemical resistance
- NPT, BSPT, BSPP, and metric threads
- Silicone Free

Markets:

- Pneumatic
- Industrial
- Robotic
- Automation
- Printing
- Packaging
- Textile

Compatible Media:

- Air
- Cutting Fluids
- Inert Gases

Compatible Tubing:

- Semi-rigid nylon
- Polyurethane 95 Durometer Shore A*
- Nylon
- Fluoropolymer
- Polyethylene

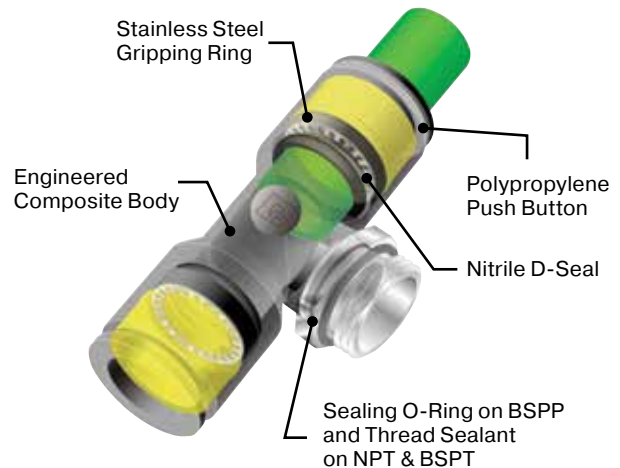

Specifications:

| | |
|--------------------------|--|
| Pressure Range | Up to 290 PSI (19.9 bar) depending on tubing |
| | Up to 260 PSI (17.9 bar) depending on tubing (3/16" size only) |
| Temperature Range | -4° to +175° F (-20° to +79.4° C) |
| | 5° to +155° F (-15° to +68.3° C) (3/16" size only) |
| Vacuum Rating | 28" Hg |

*Tube Support Required

Assembly Instructions

1. Cut tubing squarely maximum of 15° angle allowable.
2. Check that port or mating part is clean and free of debris.
3. Mark tubing to appropriate tube insertion length. (see Tube Insertion Chart on page N22)
4. Insert tubing until it bottoms
5. Pull on tubing to verify it is fully inserted
6. To disassemble, simply press release button, hold against body and pull tubing out of fitting.

WARNING These products can expose you to chemicals including NICKEL, which is known to the state of California to cause cancer. For more information go to www.P65Warnings.ca.gov.



- A
- B
- C
- D
- E
- F
- G
- H
- I
- J
- K
- L
- M
- N
- O

Threaded Fittings

W369PLP

Male Elbow
NPT, BSPT
p. A22, A23



W369PLPX

Extended Male Elbow
NPT, BSPT
p. A24



W379PLP

45° Male Elbow
NPT, BSPT
p. A24, A25



W372PLP

Male Branch Tee
NPT, BSPT
p. A25, A26



372PLP

Male Branch Tee
BSPP
p. A27



W371PLP

Male Run Tee
NPT, BSPT
p. A27, A28



W368PLP

Male Y Connector
NPT, BSPT
p. A29



W68LF

Male Connector
NPT, BSPT
p. A20, A21



68LFR

Male Connector
UNF, Straight
p. A21



66LF

Female Connector
NPT, BSPP
p. A20



377PLP

Female Branch Tee
NPT
p. A27



370PLP

Female Elbow
NPT, BSPP
p. A30



68LF

Male Connector
BSPP
p. A22



369PLP

Male Elbow
BSPP
p. A23



369PLPX

Extended Male Elbow - BSPP
p. A24



379PLP

45° Male Elbow
BSPP
p. A25



371PLP

Male Run Tee
BSPP
p. A28



368PLP

Male Y Connector
BSPP
p. A29



W368PLPD

Double Y Male Connector
BSPT
p. A30



W369PLPO

Oscillating Compact Elbow
NPT, BSPT
p. A43



369PLPO

Oscillating Compact Elbow
BSPP
p. A43



Tube to Tube Fittings

32PLP

Union
p. A33



365PLP

Union Elbow
p. A33, A34



364PLP

Union Tee
p. A34



362PLP

Union Y
p. A34



362PLPD

Double Y
p. A35



24PLP

Multiple Tee
p. A35



24PLPD

Double Multiple Tee
p. A36



347PLP

Cross
p. A36



32PLPRC

Connector for 2 Tubes
p. A40



32PLPDRC

Connector for 3 Tubes
p. A40



Bulkhead Unions

32PLPBH

Bulkhead Union
p. A35



365PLPBH

Bulkhead Elbow
p. A35



32PLPBHP

Plug-in Bulkhead Union
p. A41



WARNING These products can expose you to chemicals including NICKEL, which is known to the state of California to cause cancer. For more information go to www.P65Warnings.ca.gov.



■ Standpipes

W68PLPSP

Male Standpipe
NPT
p. A28



W68PLPSP

Male Standpipe
BSPT
p. A28



68PLPSP

Male Standpipe
BSPP
p. A29



■ Plug-In Fittings

369PLPSP

Plug-In Elbow
p. A36



369PLPSPX

Extended Plug-In
Elbow
p. A37



379PLPSP

Plug-In 45° Male
Elbow
p. A37



372PLPSP

Plug-In Branch Tee
p. A37



371PLPSP

Plug-In Run Tee
p. A37, A38



362PLPSP

Plug-In Y
p. A38



362PLPDSP

Double Plug-In Y
p. A38



37PLP

Tube Reducer
p. A39



32PLPSP

Tube Expander
p. A39



32PLPSP

Tube Converter
p. A39



322PLPSP

Barbed Connector
p. A39, A40



■ Modular Fittings

369PLPBJ

Single Banjo
BSPP
p. A31



369PLPBJB

Single Banjo Body
p. A31



32PLPDJB

Double Banjo Body
p. A31



369PLPTJB

Twin Banjo Body
p. A31



68BJB

Single Banjo Bolt
p. A31



68BJBD

Double Banjo Bolt
p. A32



68BJBT

Triple Banjo Bolt
p. A32



66BJB

Female Banjo Bolt
p. A32



376PLPBJ

Banjo with Female
Bolt
p. A32



369PLPTJ

Twin Banjo
p. A32



32PLPDJ

Double Banjo
p. A32



W369PLPBJ

Single Banjo
NPT, BSPT
p. A30



W369PLPTJ

Twin Banjo
NPT
p. A32



■ Accessories

63PLP

Double Male Union
p. A38



639PLP

Plug
p. A39



Clip

p. A40



3151

End Cap
p. A40



AQRT

Release Tool
p. A41



3110-3330

End Cap
p. A41



WARNING These products can expose you to chemicals including NICKEL, which is known to the state of California to cause cancer. For more information go to www.P65Warnings.ca.gov.

- A
- B
- C
- D
- E
- F
- G
- H
- I
- J
- K
- L
- M
- N
- O

[Click here for CADs, Product Specifications or to Configure Parts Online](#)

- A
- B
- C
- D
- E
- F
- G
- H
- I
- J
- K
- L
- M
- N
- O

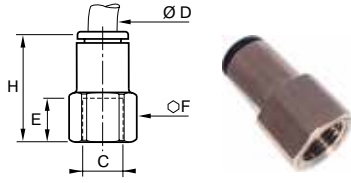

66LF Female Connector – BSPP

| PART NO. | TUBE SIZE MM | THREAD BSPP | E MM | F MM | H MM |
|-------------|--------------|-------------|------|------|------|
| 66LF-4M-M5 | 4 | M5X0.8 | 6.5 | 8 | 19.5 |
| 66LF-4M-2G | 4 | 1/8 | 9.5 | 13 | 22.5 |
| 66LF-4M-4G | 4 | 1/4 | 13.5 | 16 | 26.5 |
| 66LF-6M-2G | 6 | 1/8 | 9.5 | 13 | 24.5 |
| 66LF-6M-4G | 6 | 1/4 | 13.5 | 16 | 28.5 |
| 66LF-8M-2G | 8 | 1/8 | 9.5 | 13 | 29.0 |
| 66LF-8M-4G | 8 | 1/4 | 13.5 | 16 | 33.0 |
| 66LF-8M-6G | 8 | 3/8 | 14.0 | 19 | 34.0 |
| 66LF-10M-4G | 10 | 1/4 | 13.5 | 16 | 36.0 |
| 66LF-10M-6G | 10 | 3/8 | 14.0 | 19 | 36.0 |
| 66LF-10M-8G | 10 | 1/2 | 19.5 | 24 | 41.5 |
| 66LF-12M-4G | 12 | 1/4 | 14.0 | 19 | 39.5 |
| 66LF-12M-6G | 12 | 3/8 | 14.0 | 19 | 40.0 |
| 66LF-12M-8G | 12 | 1/2 | 19.5 | 24 | 45.5 |
| 66LF-14M-6G | 14 | 3/8 | 14.0 | 22 | 42.5 |
| 66LF-16M-8G | 16 | 1/2 | 15.0 | 27 | 49.0 |

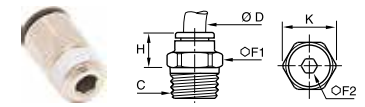

W68LF Male Connector – NPT

| PART NO. | TUBE SIZE IN | C NPT | F1 MM | F2 IN | H IN | K IN |
|------------|--------------|-------|-------|-------|-------|------|
| W68LF-2-1 | 1/8 | 1/16 | 10 | .07 | .413 | .433 |
| W68LF-2-2 | 1/8 | 1/8 | 11 | .07 | .283 | .472 |
| W68LF-2-4 | 1/8 | 1/4 | 14 | .07 | .315 | .591 |
| W68LF-4M-2 | 5/32 (4MM) | 1/8 | 11 | .11 | .334 | .472 |
| W68LF-4M-4 | 5/32 (4MM) | 1/4 | 14 | .11 | .275 | .590 |
| W68LF-4-2 | 1/4 | 1/8 | 11 | .16 | .472 | .472 |
| W68LF-4-4 | 1/4 | 1/4 | 14 | .16 | .374 | .590 |
| W68LF-4-6 | 1/4 | 3/8 | 18 | .19 | .295 | .767 |
| W68LF-8M-2 | 5/16 (8MM) | 1/8 | 13 | .19 | .787 | .551 |
| W68LF-8M-4 | 5/16 (8MM) | 1/4 | 14 | .25 | .661 | .590 |
| W68LF-8M-6 | 5/16 (8MM) | 3/8 | 18 | .25 | .464 | .767 |
| W68LF-6-2 | 3/8 | 1/8 | 16 | .16 | .894 | .689 |
| W68LF-6-4 | 3/8 | 1/4 | 16 | .28 | .807 | .689 |
| W68LF-6-6 | 3/8 | 3/8 | 18 | .28 | .689 | .767 |
| W68LF-6-8 | 3/8 | 1/2 | 22 | .28 | .610 | .945 |
| W68LF-8-4 | 1/2 | 1/4 | 22 | .25 | 1.100 | .945 |
| W68LF-8-6 | 1/2 | 3/8 | 22 | .28 | 1.100 | .945 |
| W68LF-8-8 | 1/2 | 1/2 | 22 | .28 | 1.100 | .945 |

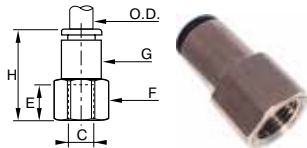

66LF Female Connector – NPT

| PART NO. | TUBE SIZE IN | THREAD NPT | F MM | G IN | H IN | E IN |
|-----------|--------------|------------|------|------|------|------|
| 66LF-2-2 | 1/8 | 1/8 | 13 | .43 | .87 | .37 |
| 66LF-2-4 | 1/8 | 1/4 | 16 | .43 | 1.05 | .55 |
| 66LF-4M-2 | 5/32 (4MM) | 1/8 | 13 | .35 | .89 | .37 |
| 66LF-4M-4 | 5/32 (4MM) | 1/4 | 16 | .33 | 1.06 | .55 |
| 66LF-4-2 | 1/4 | 1/8 | 13 | .42 | .98 | .37 |
| 66LF-4-4 | 1/4 | 1/4 | 16 | .42 | 1.16 | .55 |
| 66LF-8M-2 | 5/16 (8MM) | 1/8 | 13 | .53 | 1.14 | .37 |
| 66LF-8M-4 | 5/16 (8MM) | 1/4 | 16 | .53 | 1.32 | .55 |
| 66LF-6-2 | 3/8 | 1/8 | 16 | .61 | 1.22 | .37 |
| 66LF-6-4 | 3/8 | 1/4 | 16 | .61 | 1.40 | .55 |
| 66LF-6-6 | 3/8 | 3/8 | 22 | .61 | 1.52 | .65 |
| 66LF-8-4 | 1/2 | 1/4 | 20 | .84 | 1.73 | .47 |
| 66LF-8-6 | 1/2 | 3/8 | 22 | .85 | 1.81 | .65 |
| 66LF-8-8 | 1/2 | 1/2 | 24 | .85 | 1.93 | .77 |

WARNING These products can expose you to chemicals including NICKEL, which is known to the state of California to cause cancer. For more information go to www.P65Warnings.ca.gov.

Click here for CADs, Product Specifications or to Configure Parts Online

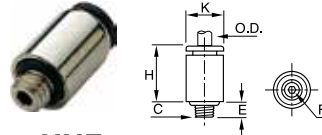

68LFR Male Connector – UNF

| PART NO. | TUBE SIZE IN | C UNF | E IN | F MM | H IN | K IN |
|------------|--------------|-------|------|------|------|------|
| 68LFR-2-0 | 1/8 | 10-32 | .13 | 2.0 | .49 | .32 |
| 68LFR-4M-0 | 5/32 (4MM) | 10-32 | .13 | 2.0 | .54 | .34 |
| 68LFR-4-0 | 1/4 | 10-32 | .13 | 2.0 | .64 | .46 |
| 68LFR-4-M5 | 1/4 | M5 | .14 | 2.5 | .65 | .41 |
| 68LFR-4-M7 | 1/4 | M7 | .18 | 4.0 | .65 | .41 |

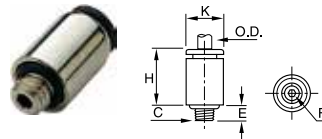

68LFR Male Connector Metric Straight Thread

| PART NO. | TUBE SIZE MM | C UNF | E MM | F MM | H MM | K MM |
|-------------|--------------|--------|------|------|------|------|
| 68LFR-4M-M7 | 4 | M7X1 | 4.6 | 3 | 14 | 9.95 |
| 68LFR-4M-M5 | 4 | M5X0.8 | 3.5 | 2.5 | 14.5 | 8.50 |
| 68LFR-6M-M7 | 6 | M7X1 | 4.6 | 3 | 16 | 9.90 |

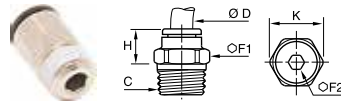

W68LF Male Connector – BSPT

| PART NO. | TUBE SIZE IN | C BSPT | F1 MM | F2 MM | H IN | K IN |
|---------------|--------------|--------|-------|-------|-------|-------|
| W68LF-2-2R | 1/8 | 1/8 | 10 | 2 | .335 | .433 |
| W68LF-5/32-2R | 5/32 | 1/8 | 10 | 3 | .370 | .430 |
| W68LF-5/32-4R | 5/32 | 1/4 | 14 | 3 | .260 | .590 |
| W68LF-3-2R | 3/16 | 1/8 | 11 | 3 | .610 | .510 |
| W68LF-3-4R | 3/16 | 1/4 | 14 | 3 | .590 | .650 |
| W68LF-4-2R | 1/4 | 1/8 | 11 | 4 | .472 | .472 |
| W68LF-4-4R | 1/4 | 1/4 | 14 | 4 | .374 | .591 |
| W68LF-5-2R | 5/16 | 1/8 | 13 | 5 | .790 | .550 |
| W68LF-5-4R | 5/16 | 1/4 | 14 | 6 | .670 | .590 |
| W68LF-5-6R | 5/16 | 3/8 | 17 | 6 | .510 | .730 |
| W68LF-5-8R | 5/16 | 1/2 | 21 | 6 | .470 | .910 |
| W68LF-6-4R | 3/8 | 1/4 | 16 | 7 | .807 | .689 |
| W68LF-6-6R | 3/8 | 3/8 | 17 | 7 | .650 | .728 |
| W68LF-6-8R | 3/8 | 1/2 | 21 | 7 | .551 | .906 |
| W68LF-8-4R | 1/2 | 1/4 | 22 | 6 | 1.060 | .945 |
| W68LF-8-6R | 1/2 | 3/8 | 22 | 7 | 1.020 | .945 |
| W68LF-8-8R | 1/2 | 1/2 | 24 | 7 | .807 | 1.020 |

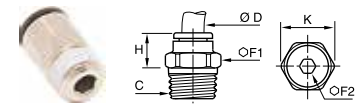

W68LF Male Connector Metric to NPT

| PART NO. | TUBE SIZE MM | C NPT | F1 MM | F2 IN | H IN | K IN |
|-------------|--------------|-------|-------|-------|------|------|
| W68LF-4M-2 | 4 | 1/8 | 11 | 3 | .33 | .47 |
| W68LF-4M-4 | 4 | 1/4 | 14 | 3 | .28 | .59 |
| W68LF-6M-2 | 6 | 1/8 | 11 | 4 | .45 | .47 |
| W68LF-6M-4 | 6 | 1/4 | 14 | 4 | .33 | .59 |
| W68LF-8M-2 | 8 | 1/8 | 13 | 5 | .79 | .55 |
| W68LF-8M-4 | 8 | 1/4 | 14 | 6 | .66 | .59 |
| W68LF-8M-6 | 8 | 3/8 | 18 | 6 | .46 | .77 |
| W68LF-10M-4 | 10 | 1/4 | 16 | 7 | .79 | .69 |
| W68LF-10M-6 | 10 | 3/8 | 18 | 8 | .65 | .77 |
| W68LF-10M-8 | 10 | 1/2 | 22 | 8 | .55 | .95 |
| W68LF-12M-6 | 12 | 3/8 | 19 | 9 | .95 | .83 |
| W68LF-12M-8 | 12 | 1/2 | 22 | 10 | .77 | .95 |

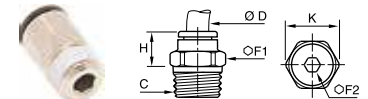

W68LF Male Connector Metric to BSPT

| PART NO. | TUBE SIZE MM | C BSPT | F1 MM | F2 MM | H MM | K MM |
|--------------|--------------|--------|-------|-------|------|------|
| W68LF-4M-2R | 4 | 1/8 | 10 | 3 | 9.5 | 11.0 |
| W68LF-4M-4R | 4 | 1/4 | 14 | 3 | 6.5 | 15.0 |
| W68LF-4M-6R | 4 | 3/8 | 17 | 3 | 8.0 | 18.5 |
| W68LF-6M-2R | 6 | 1/8 | 11 | 4 | 11.5 | 11.0 |
| W68LF-6M-4R | 6 | 1/4 | 14 | 4 | 8.5 | 15.0 |
| W68LF-6M-6R | 6 | 3/8 | 17 | 4 | 8.5 | 18.5 |
| W68LF-6M-8R | 6 | 1/2 | 21 | 4 | 9.0 | 23.0 |
| W68LF-8M-2R | 8 | 1/8 | 13 | 5 | 20.0 | 14.0 |
| W68LF-8M-4R | 8 | 1/4 | 14 | 6 | 17.0 | 15.0 |
| W68LF-8M-8R | 8 | 1/2 | 21 | 6 | 12.0 | 23.0 |
| W68LF-10M-2R | 10 | 1/8 | 16 | 5 | 22.5 | 17.5 |
| W68LF-10M-4R | 10 | 1/4 | 16 | 7 | 20.0 | 17.5 |
| W68LF-10M-6R | 10 | 3/8 | 17 | 8 | 16.5 | 18.5 |
| W68LF-10M-8R | 10 | 1/2 | 21 | 8 | 14.0 | 23.0 |
| W68LF-12M-4R | 12 | 1/4 | 19 | 7 | 26.5 | 21.0 |
| W68LF-12M-6R | 12 | 3/8 | 19 | 9 | 24.0 | 21.0 |
| W68LF-12M-8R | 12 | 1/2 | 21 | 9 | 19.5 | 23.0 |
| W68LF-14M-6R | 14 | 3/8 | 22 | 9 | 28.5 | 24.0 |
| W68LF-14M-8R | 14 | 1/2 | 24 | 10 | 23.5 | 26.0 |

WARNING These products can expose you to chemicals including NICKEL, which is known to the state of California to cause cancer. For more information go to www.P65Warnings.ca.gov.



Click here for CADs, Product Specifications or to Configure Parts Online

- A
- B
- C
- D
- E
- F
- G
- H
- I
- J
- K
- L
- M
- N
- O

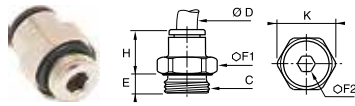

68LF Male Connector Metric to BSPP

| PART NO. | TUBE SIZE MM | C BSPP | E MM | F1 MM | F2 MM | H MM | K MM |
|-------------|--------------|---------|------|-------|-------|------|------|
| 68LF-3M-M3 | 3 | M3X0.5 | 2.50 | 8 | - | 12.5 | 8.5 |
| 68LF-3M-M5 | 3 | M5X0.8 | 3.50 | 8 | 2.5 | 12.5 | 8.5 |
| 68LF-4M-M3 | 4 | M3X0.5 | 2.50 | 8 | - | 14.5 | 8.5 |
| 68LF-4M-M5 | 4 | M5X0.8 | 3.50 | 8 | 2.5 | 14.0 | 8.5 |
| 68LF-4M-M7 | 4 | M7X1 | 5.00 | 10 | 2.5 | 14.0 | 11.0 |
| 68LF-4M-2G | 4 | 1/8 | 4.50 | 13 | 3.0 | 11.5 | 14.0 |
| 68LF-4M-4G | 4 | 1/4 | 5.50 | 16 | 3.0 | 10.5 | 17.5 |
| 68LF-6M-M5 | 6 | M5X0.8 | 3.50 | 10 | 2.5 | 16.0 | 11.0 |
| 68LF-6M-M7 | 6 | M7X1 | 5.00 | 10 | 3.0 | 16.0 | 11.0 |
| 68LF-6M-M10 | 6 | M10X1 | 5.00 | 13 | 4.0 | 13.0 | 14.0 |
| 68LF-6M-M12 | 6 | M12X1.5 | 5.50 | 15 | 4.0 | 13.0 | 16.0 |
| 68LF-6M-2G | 6 | 1/8 | 4.50 | 13 | 4.0 | 13.0 | 14.0 |
| 68LF-6M-4G | 6 | 1/4 | 5.50 | 16 | 4.0 | 12.5 | 17.5 |
| 68LF-6M-6G | 6 | 3/8 | 5.50 | 20 | 4.0 | 13.0 | 22.0 |
| 68LF-6M-8G | 6 | 1/2 | 7.50 | 24 | 4.0 | 20.0 | 26.0 |
| 68LF-8M-M10 | 8 | M10X1 | 5.00 | 13 | 5.0 | 21.0 | 14.0 |
| 68LF-8M-M12 | 8 | M12X1.5 | 5.50 | 15 | 5.0 | 21.0 | 16.0 |
| 68LF-8M-2G | 8 | 1/8 | 4.50 | 13 | 5.0 | 20.5 | 14.0 |
| 68LF-8M-4G | 8 | 1/4 | 5.50 | 16 | 6.0 | 19.5 | 17.5 |
| 68LF-8M-6G | 8 | 3/8 | 5.50 | 20 | 6.0 | 18.0 | 22.0 |
| 68LF-8M-8G | 8 | 1/2 | 7.50 | 24 | 6.0 | 16.5 | 26.0 |
| 68LF-10M-4G | 10 | 1/4 | 5.50 | 16 | 7.0 | 23.0 | 17.5 |
| 68LF-10M-6G | 10 | 3/8 | 5.50 | 20 | 8.0 | 19.5 | 22.0 |
| 68LF-10M-8G | 10 | 1/2 | 7.50 | 24 | 8.0 | 18.5 | 26.0 |
| 68LF-12M-4G | 12 | 1/4 | 5.50 | 19 | 7.0 | 27.5 | 21.0 |
| 68LF-12M-6G | 12 | 3/8 | 5.50 | 20 | 9.0 | 27.0 | 22.0 |
| 68LF-12M-8G | 12 | 1/2 | 7.00 | 24 | 10.0 | 22.5 | 26.0 |
| 68LF-14M-6G | 14 | 3/8 | 5.50 | 22 | 9.0 | 29.5 | 24.0 |
| 68LF-14M-8G | 14 | 1/2 | 7.00 | 24 | 11.0 | 28.0 | 26.0 |

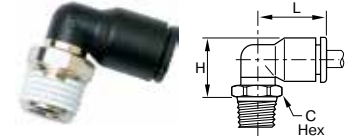

W369PLP Male Elbow - NPT

| PART NO. | TUBE SIZE IN | THREAD NPT / UNF | C HEX MM | L | H |
|--------------|--------------|------------------|----------|------|------|
| 369PLP-2-0 | 1/8 | 10-32 | 8 | .57 | .52 |
| W369PLP-2-1 | 1/8 | 1/16 | 10 | .57 | .53 |
| W369PLP-2-2 | 1/8 | 1/8 | 11 | .57 | .53 |
| W369PLP-2-4 | 1/8 | 1/4 | 14 | .57 | .55 |
| 369PLP-4M-0 | 5/32 (4MM) | 10-32 | 8 | .55 | .53 |
| W369PLP-4M-2 | 5/32 (4MM) | 1/8 | 11 | .55 | .53 |
| W369PLP-4M-4 | 5/32 (4MM) | 1/4 | 14 | .55 | .55 |
| W369PLP-3-2 | 3/16 | 1/8 | 11 | .85 | .67 |
| 369PLP-4-0 | 1/4 | 10-32 | 11 | .71 | .63 |
| W369PLP-4-2 | 1/4 | 1/8 | 11 | .71 | .67 |
| W369PLP-4-4 | 1/4 | 1/4 | 14 | .71 | .63 |
| W369PLP-4-6 | 1/4 | 3/8 | 18 | .71 | .65 |
| W369PLP-8M-2 | 5/16 (8MM) | 1/8 | 11 | .91 | .75 |
| W369PLP-8M-4 | 5/16 (8MM) | 1/4 | 14 | .91 | .71 |
| W369PLP-8M-6 | 5/16 (8MM) | 3/8 | 18 | .91 | .73 |
| W369PLP-6-2 | 3/8 | 1/8 | 15 | 1.08 | .91 |
| W369PLP-6-4 | 3/8 | 1/4 | 15 | 1.08 | .91 |
| W369PLP-6-6 | 3/8 | 3/8 | 18 | 1.08 | .87 |
| W369PLP-6-8 | 3/8 | 1/2 | 22 | 1.08 | .91 |
| W369PLP-8-4 | 1/2 | 1/4 | 20 | 1.38 | 1.22 |
| W369PLP-8-6 | 1/2 | 3/8 | 20 | 1.38 | 1.22 |
| W369PLP-8-8 | 1/2 | 1/2 | 24 | 1.38 | 1.12 |



W369PLP Male Elbow - BSPT

| PART NO. | TUBE SIZE IN | THREAD BSPT | C HEX MM | L | H |
|---------------|--------------|-------------|----------|------|------|
| W369PLP-2-2R | 1/8 | 1/8 | 10 | .57 | .53 |
| W369PLP-4M-2R | 5/32 (4M) | 1/8 | 10 | .55 | .53 |
| W369PLP-4M-4R | 5/32 (4M) | 1/4 | 14 | .55 | .55 |
| W369PLP-3-2R | 3/16 | 1/8 | 11 | .85 | .67 |
| W369PLP-4-2R | 1/4 | 1/8 | 10 | .71 | .67 |
| W369PLP-4-4R | 1/4 | 1/4 | 14 | .71 | .63 |
| W369PLP-8M-2R | 5/16 (8M) | 1/8 | 10 | .91 | .75 |
| W369PLP-8M-4R | 5/16 (8M) | 1/4 | 14 | .91 | .71 |
| W369PLP-8M-6R | 5/16 (8M) | 3/8 | 17 | .91 | .71 |
| W369PLP-8M-8R | 5/16 (8M) | 1/2 | 21 | .91 | .77 |
| W369PLP-6-4R | 3/8 | 1/4 | 15 | 1.04 | .87 |
| W369PLP-6-6R | 3/8 | 3/8 | 17 | 1.04 | .87 |
| W369PLP-8-4R | 1/2 | 1/4 | 20 | 1.38 | 1.22 |
| W369PLP-8-6R | 1/2 | 3/8 | 20 | 1.38 | 1.22 |
| W369PLP-8-8R | 1/2 | 1/2 | 24 | 1.38 | 1.12 |

WARNING These products can expose you to chemicals including NICKEL, which is known to the state of California to cause cancer. For more information go to www.P65Warnings.ca.gov.



[Click here for CADs, Product Specifications or to Configure Parts Online](#)

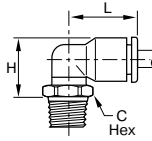

W369PLP Male Elbow - NPT

| PART NO. | TUBE SIZE MM | THREAD NPT | C HEX MM | H | L |
|---------------|--------------|------------|----------|------|------|
| W369PLP-4M-2 | 4 | 1/8 | 11 | .53 | .55 |
| W369PLP-4M-4 | 4 | 1/4 | 14 | .55 | .55 |
| W369PLP-6M-2 | 6 | 1/8 | 11 | .61 | .63 |
| W369PLP-6M-4 | 6 | 1/4 | 14 | .63 | .63 |
| W369PLP-8M-2 | 8 | 1/8 | 11 | .75 | .91 |
| W369PLP-8M-4 | 8 | 1/4 | 14 | .71 | .91 |
| W369PLP-8M-6 | 8 | 3/8 | 18 | .73 | .91 |
| W369PLP-10M-4 | 10 | 1/4 | 15 | .91 | 1.04 |
| W369PLP-10M-6 | 10 | 3/8 | 18 | .87 | 1.04 |
| W369PLP-10M-8 | 10 | 1/2 | 22 | .91 | 1.04 |
| W369PLP-12M-6 | 12 | 3/8 | 18 | .98 | 1.22 |
| W369PLP-12M-8 | 12 | 1/2 | 22 | 1.02 | 1.22 |

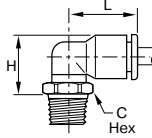

W369PLP Male Elbow - BSPT

| PART NO. | TUBE SIZE MM | THREAD BSPT | C HEX MM | H | L |
|----------------|--------------|-------------|----------|------|------|
| W369PLP-4M-2R | 4 | 1/8 | 10 | 13.5 | 14.0 |
| W369PLP-4M-4R | 4 | 1/4 | 14 | 14.0 | 14.0 |
| W369PLP-4M-6R | 4 | 3/8 | 17 | 13.5 | 14.0 |
| W369PLP-6M-2R | 6 | 1/8 | 10 | 15.5 | 16.0 |
| W369PLP-6M-4R | 6 | 1/4 | 14 | 16.0 | 16.0 |
| W369PLP-6M-6R | 6 | 3/8 | 17 | 16.0 | 16.0 |
| W369PLP-6M-8R | 6 | 1/2 | 21 | 16.5 | 16.0 |
| W369PLP-8M-2R | 8 | 1/8 | 10 | 19.0 | 23.0 |
| W369PLP-8M-4R | 8 | 1/4 | 14 | 18.0 | 23.0 |
| W369PLP-8M-6R | 8 | 3/8 | 17 | 18.0 | 23.0 |
| W369PLP-8M-8R | 8 | 1/2 | 21 | 19.5 | 23.0 |
| W369PLP-10M-2R | 10 | 1/8 | 15 | 23.0 | 26.5 |
| W369PLP-10M-4R | 10 | 1/4 | 15 | 22.0 | 26.5 |
| W369PLP-10M-6R | 10 | 3/8 | 17 | 22.0 | 26.5 |
| W369PLP-10M-8R | 10 | 1/2 | 21 | 22.0 | 26.5 |
| W369PLP-12M-4R | 12 | 1/4 | 15 | 25.0 | 31.0 |
| W369PLP-12M-6R | 12 | 3/8 | 17 | 25.0 | 31.0 |
| W369PLP-12M-8R | 12 | 1/2 | 21 | 25.0 | 31.0 |
| W369PLP-14M-6R | 14 | 3/8 | 20 | 30.5 | 35.5 |
| W369PLP-14M-8R | 14 | 1/2 | 24 | 28.5 | 35.5 |
| W369PLP-16M-6R | 16 | 3/8 | 27 | 53 | 39.0 |
| W369PLP-16M-8R | 16 | 1/2 | 27 | 53 | 39.0 |

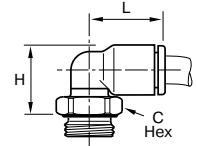

369PLP Male Elbow - BSPP

| PART NO. | TUBE SIZE MM | BSPP / METRIC | C HEX MM | H | L |
|---------------|--------------|---------------|----------|------|------|
| 369PLP-3M-M3 | 3 | M3X0.5 | 8 | 15.0 | 14.5 |
| 369PLP-3M-M5 | 3 | M5X0.8 | 8 | 13.5 | 14.5 |
| 369PLP-4M-M3 | 4 | M3X0.5 | 8 | 15.0 | 14.5 |
| 369PLP-4M-M5 | 4 | M5X0.8 | 8 | 13.5 | 14.0 |
| 369PLP-4M-2G | 4 | 1/8 | 13 | 13.0 | 14.0 |
| 369PLP-4M-4G | 4 | 1/4 | 16 | 13.0 | 14.0 |
| 369PLP-6M-M5 | 6 | M5X0.8 | 8 | 15.5 | 16.0 |
| 369PLP-6M-M7 | 6 | M7X1 | 10 | 17.5 | 16.0 |
| 369PLP-6M-M10 | 6 | M10X1 | 13 | 15.0 | 14.0 |
| 369PLP-6M-M12 | 6 | M12X1.5 | 15 | 15.0 | 16.0 |
| 369PLP-6M-2G | 6 | 1/8 | 13 | 15.0 | 16.0 |
| 369PLP-6M-4G | 6 | 1/4 | 16 | 15.0 | 16.0 |
| 369PLP-6M-6G | 6 | 3/8 | 20 | 15.5 | 16.0 |
| 369PLP-6M-8G | 6 | 1/2 | 24 | 16.0 | 16.0 |
| 369PLP-8M-M10 | 8 | M10X1 | 13 | 20.5 | 23.0 |
| 369PLP-8M-M12 | 8 | M12X1.5 | 15 | 19.5 | 23.0 |
| 369PLP-8M-2G | 8 | 1/8 | 13 | 20.5 | 23.0 |
| 369PLP-8M-4G | 8 | 1/4 | 16 | 18.5 | 23.0 |
| 369PLP-8M-6G | 8 | 3/8 | 20 | 18.5 | 23.0 |
| 369PLP-8M-8G | 8 | 1/2 | 24 | 19.0 | 23.0 |
| 369PLP-10M-4G | 10 | 1/4 | 16 | 23.5 | 26.5 |
| 369PLP-10M-6G | 10 | 3/8 | 20 | 22.0 | 26.5 |
| 369PLP-10M-8G | 10 | 1/2 | 24 | 22.0 | 26.5 |
| 369PLP-12M-4G | 12 | 1/4 | 16 | 26.5 | 31.0 |
| 369PLP-12M-6G | 12 | 3/8 | 20 | 25.0 | 31.0 |
| 369PLP-12M-8G | 12 | 1/2 | 24 | 25.0 | 31.0 |
| 369PLP-14M-6G | 14 | 3/8 | 20 | 32.5 | 35.5 |
| 369PLP-14M-8G | 14 | 1/2 | 24 | 27.0 | 35.5 |
| 369PLP-16M-6G | 16 | 3/8 | 27 | 54.5 | 39 |
| 369PLP-16M-8G | 16 | 1/2 | 27 | 54.5 | 39 |

WARNING These products can expose you to chemicals including NICKEL, which is known to the state of California to cause cancer. For more information go to www.P65Warnings.ca.gov.



[Click here for CADs, Product Specifications or to Configure Parts Online](#)

- A
- B
- C
- D
- E
- F
- G
- H
- I
- J
- K
- L
- M
- N
- O

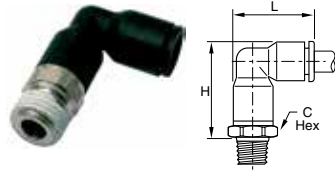

W369PLPX Extended Male Elbow - NPT

| PART NO. | TUBE SIZE IN | THREAD NPT / UNF | C HEX MM | H | L |
|---------------|--------------|------------------|----------|------|------|
| 369PLPX-2-0 | 1/8 | 10-32 | 8 | .91 | .75 |
| W369PLPX-2-2 | 1/8 | 1/8 | 11 | .91 | .75 |
| W369PLPX-2-4 | 1/8 | 1/4 | 14 | .93 | .75 |
| 369PLPX-4M-0 | 5/32 (4MM) | 10-32 | 8 | .91 | .75 |
| W369PLPX-4M-2 | 5/32 (4MM) | 1/8 | 11 | .91 | .75 |
| W369PLPX-4M-4 | 5/32 (4MM) | 1/4 | 14 | .93 | .75 |
| 369PLPX-4-0 | 1/4 | 10-32 | 11 | 1.10 | .93 |
| 369PLPX-4-M7 | 1/4 | M7 | 9 | 1.17 | .93 |
| W369PLPX-4-2 | 1/4 | 1/8 | 11 | 1.12 | .93 |
| W369PLPX-4-4 | 1/4 | 1/4 | 14 | 1.08 | .93 |
| W369PLPX-4-6 | 1/4 | 3/8 | 17 | 1.12 | .93 |
| W369PLPX-8M-2 | 5/16 (8MM) | 1/8 | 13 | 1.32 | 1.16 |
| W369PLPX-8M-4 | 5/16 (8MM) | 1/4 | 14 | 1.28 | 1.16 |
| W369PLPX-6-2 | 3/8 | 1/8 | 17 | 1.40 | 1.34 |
| W369PLPX-6-4 | 3/8 | 1/4 | 17 | 1.41 | 1.33 |
| W369PLPX-6-6 | 3/8 | 3/8 | 18 | 1.45 | 1.33 |

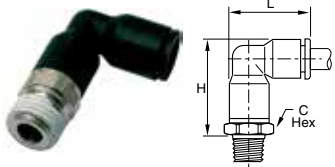

W369PLPX Extended Male Elbow - BSPT

| PART NO. | TUBE SIZE MM | THREAD BSPT | C HEX MM | H | L |
|-----------------|--------------|-------------|----------|------|------|
| W369PLPX-4M-2R | 4 | 1/8 | 10 | 23.0 | 19.0 |
| W369PLPX-4M-4R | 4 | 1/4 | 14 | 23.5 | 19.0 |
| W369PLPX-6M-2R | 6 | 1/8 | 10 | 27.0 | 22.5 |
| W369PLPX-6M-4R | 6 | 1/4 | 14 | 27.5 | 22.5 |
| W369PLPX-8M-2R | 8 | 1/8 | 13 | 34.5 | 29.5 |
| W369PLPX-8M-4R | 8 | 1/4 | 14 | 32.5 | 29.5 |
| W369PLPX-8M-6R | 8 | 3/8 | 17 | 33.0 | 29.5 |
| W369PLPX-10M-4R | 10 | 1/4 | 15 | 39.5 | 34.5 |
| W369PLPX-10M-6R | 10 | 3/8 | 17 | 39.5 | 34.5 |
| W369PLPX-10M-8R | 10 | 1/2 | 21 | 39.5 | 34.5 |
| W369PLPX-12M-4R | 12 | 1/4 | 19 | 45.5 | 40.5 |
| W369PLPX-12M-6R | 12 | 3/8 | 19 | 45.5 | 40.5 |
| W369PLPX-12M-8R | 12 | 1/2 | 21 | 45.5 | 40.5 |
| W369PLPX-14M-6R | 14 | 3/8 | 21 | 51.5 | 46.5 |
| W369PLPX-14M-8R | 14 | 1/2 | 21 | 51.5 | 46.5 |

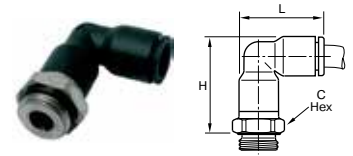

369PLPX Extended Male Elbow - BSPP

| PART NO. | TUBE SIZE MM | BSPP / METRIC | C HEX MM | H |
|----------------|--------------|---------------|----------|------|
| 369PLPX-4M-M5 | 4 | M5X0.8 | 8 | 23.0 |
| 369PLPX-4M-M7 | 4 | M7X1 | 10 | 22.5 |
| 369PLPX-4M-2G | 4 | 1/8 | 13 | 22.5 |
| 369PLPX-4M-4G | 4 | 1/4 | 16 | 22.5 |
| 369PLPX-6M-M5 | 6 | M5X0.8 | 10 | 27.5 |
| 369PLPX-6M-M7 | 6 | M7X1 | 10 | 26.0 |
| 369PLPX-6M-2G | 6 | 1/8 | 13 | 27.0 |
| 369PLPX-6M-4G | 6 | 1/4 | 16 | 27.0 |
| 369PLPX-8M-2G | 8 | 1/8 | 13 | 36.0 |
| 369PLPX-8M-4G | 8 | 1/4 | 16 | 33.0 |
| 369PLPX-8M-6G | 8 | 3/8 | 20 | 33.0 |
| 369PLPX-10M-4G | 10 | 1/4 | 16 | 40.5 |
| 369PLPX-10M-6G | 10 | 3/8 | 20 | 40.5 |
| 369PLPX-10M-8G | 10 | 1/2 | 24 | 40.5 |
| 369PLPX-12M-4G | 12 | 1/4 | 19 | 44.5 |
| 369PLPX-12M-6G | 12 | 3/8 | 20 | 42.0 |
| 369PLPX-12M-8G | 12 | 1/2 | 24 | 42.0 |
| 369PLPX-14M-6G | 14 | 3/8 | 22 | 51.0 |
| 369PLPX-14M-8G | 14 | 1/2 | 24 | 48.5 |



W379PLP Male Elbow 45° - NPT

| PART NO. | TUBE SIZE IN | THREAD NPT / UNF | C HEX MM | H | L |
|-------------|--------------|------------------|----------|------|-----|
| 379PLP-2-0 | 1/8 | 10-32 | 8 | .91 | .49 |
| W379PLP-2-2 | 1/8 | 1/8 | 11 | .81 | .49 |
| W379PLP-4-2 | 1/4 | 1/8 | 11 | .98 | .57 |
| W379PLP-4-4 | 1/4 | 1/4 | 14 | .98 | .57 |
| W379PLP-6-4 | 3/8 | 1/4 | 17 | 1.36 | .91 |
| W379PLP-6-6 | 3/8 | 3/8 | 18 | 1.36 | .91 |

WARNING These products can expose you to chemicals including NICKEL, which is known to the state of California to cause cancer. For more information go to www.P65Warnings.ca.gov.

Click here for CADs, Product Specifications or to Configure Parts Online

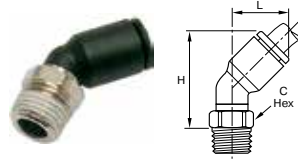

W379PLP 45° Male Elbow - BSPT

| PART NO. | TUBE SIZE MM | BSPT | C HEX MM | H | L |
|----------------|--------------|------|----------|------|------|
| W379PLP-4M-2R | 4 | 1/8 | 10 | 24.5 | 13.0 |
| W379PLP-6M-2R | 6 | 1/8 | 10 | 28.0 | 14.5 |
| W379PLP-6M-4R | 6 | 1/4 | 14 | 30.0 | 14.5 |
| W379PLP-8M-2R | 8 | 1/8 | 10 | 33.5 | 19.5 |
| W379PLP-8M-4R | 8 | 1/4 | 14 | 33.5 | 19.5 |
| W379PLP-8M-6R | 8 | 3/8 | 17 | 33.5 | 19.5 |
| W379PLP-10M-4R | 10 | 1/4 | 15 | 38.5 | 23.0 |
| W379PLP-10M-6R | 10 | 3/8 | 17 | 39.0 | 23.0 |
| W379PLP-10M-8R | 10 | 1/2 | 21 | 40.5 | 23.0 |
| W379PLP-12M-4R | 12 | 1/4 | 15 | 44.0 | 26.0 |
| W379PLP-12M-6R | 12 | 3/8 | 17 | 44.0 | 26.0 |
| W379PLP-12M-8R | 12 | 1/2 | 21 | 46.0 | 26.0 |

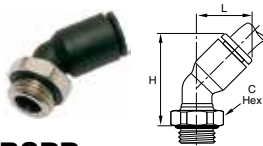

379PLP 45° Male Elbow - BSPP

| PART NO. | TUBE SIZE MM | BSPP / M5 | C HEX MM | H | L |
|---------------|--------------|-----------|----------|------|------|
| 379PLP-4M-M5 | 4 | M5X0.8 | 8 | 23.0 | 13.0 |
| 379PLP-4M-2G | 4 | 1/8 | 13 | 25.0 | 13.0 |
| 379PLP-6M-M5 | 6 | M5X0.8 | 8 | 30.0 | 14.5 |
| 379PLP-6M-2G | 6 | 1/8 | 13 | 28.5 | 14.5 |
| 379PLP-6M-4G | 6 | 1/4 | 16 | 29.5 | 14.5 |
| 379PLP-8M-2G | 8 | 1/8 | 13 | 36.0 | 19.5 |
| 379PLP-8M-4G | 8 | 1/4 | 16 | 34.5 | 19.5 |
| 379PLP-8M-6G | 8 | 3/8 | 20 | 34.5 | 19.5 |
| 379PLP-10M-4G | 10 | 1/4 | 16 | 40.5 | 23.0 |
| 379PLP-10M-6G | 10 | 3/8 | 20 | 39.0 | 23.0 |
| 379PLP-10M-8G | 10 | 1/2 | 24 | 41.0 | 23.0 |
| 379PLP-12M-4G | 12 | 1/4 | 16 | 46.0 | 26.0 |
| 379PLP-12M-6G | 12 | 3/8 | 20 | 44.5 | 26.0 |
| 379PLP-12M-8G | 12 | 1/2 | 24 | 46.0 | 26.0 |

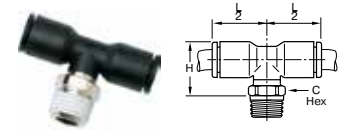

W372PLP Male Branch Tee - NPT

| PART NO. | TUBE SIZE IN | THREAD NPT / UNF | C HEX MM | L/2 | H |
|--------------|--------------|------------------|----------|------|------|
| 372PLP-2-0 | 1/8 | 10-32 | 8 | .57 | .61 |
| W372PLP-2-1 | 1/8 | 1/16 | 10 | .57 | .61 |
| W372PLP-2-2 | 1/8 | 1/8 | 11 | .57 | .61 |
| W372PLP-2-4 | 1/8 | 1/4 | 14 | .57 | .63 |
| 372PLP-4M-0 | 5/32 (4MM) | 10-32 | 8 | .55 | .71 |
| W372PLP-4M-4 | 5/32 (4MM) | 1/4 | 14 | .55 | .63 |
| W372PLP-3-2 | 3/16 | 1/8 | 11 | .85 | .67 |
| W372PLP-4-2 | 1/4 | 1/8 | 11 | .71 | .67 |
| W372PLP-4-4 | 1/4 | 1/4 | 14 | .71 | .63 |
| W372PLP-4-6 | 1/4 | 3/8 | 18 | .71 | .65 |
| W372PLP-5-2 | 5/16 | 1/8 | 11 | .91 | .87 |
| W372PLP-5-4 | 5/16 | 1/4 | 14 | .91 | .83 |
| W372PLP-5-6 | 5/16 | 3/8 | 18 | .91 | .85 |
| W372PLP-6-2 | 3/8 | 1/8 | 15 | 1.04 | .99 |
| W372PLP-6-4 | 3/8 | 1/4 | 15 | 1.04 | .99 |
| W372PLP-6-6 | 3/8 | 3/8 | 18 | 1.04 | .95 |
| W372PLP-6-8 | 3/8 | 1/2 | 22 | 1.04 | .98 |
| W372PLP-8-4 | 1/2 | 1/4 | 20 | 1.38 | 1.22 |
| W372PLP-8-6 | 1/2 | 3/8 | 20 | 1.38 | 1.22 |
| W372PLP-8-8 | 1/2 | 1/2 | 24 | 1.38 | 1.21 |

WARNING These products can expose you to chemicals including NICKEL, which is known to the state of California to cause cancer. For more information go to www.P65Warnings.ca.gov.



Click here for CADs, Product Specifications or to Configure Parts Online

- A
- B
- C
- D
- E
- F
- G
- H
- I
- J
- K
- L
- M
- N
- O



W372PLP Male Branch Tee - BSPT

| PART NO. | TUBE SIZE IN | THREAD BSPT | C HEX MM | L/2 | H |
|---------------|--------------|-------------|----------|------|------|
| W372PLP-2-2R | 1/8 | 1/8 | 10 | .55 | .61 |
| W372PLP-4M-2R | 5/32 (4MM) | 1/8 | 10 | .55 | .61 |
| W372PLP-4M-4R | 5/32 (4MM) | 1/4 | 14 | .55 | .63 |
| W372PLP-3-2R | 3/16 | 1/8 | 11 | .85 | .67 |
| W372PLP-3-4R | 3/16 | 1/4 | 14 | .85 | .67 |
| W372PLP-4-2R | 1/4 | 1/8 | 10 | .71 | .67 |
| W372PLP-4-4R | 1/4 | 1/4 | 14 | .71 | .63 |
| W372PLP-8M-2R | 5/16 (8MM) | 1/8 | 10 | .91 | .87 |
| W372PLP-8M-4R | 5/16 (8MM) | 1/4 | 14 | .91 | .83 |
| W372PLP-8M-6R | 5/16 (8MM) | 3/8 | 17 | .91 | .83 |
| W372PLP-6-4R | 3/8 | 1/4 | 15 | 1.04 | .95 |
| W372PLP-6-6R | 3/8 | 3/8 | 17 | 1.04 | .95 |
| W372PLP-8-4R | 1/2 | 1/4 | 20 | 1.38 | 1.24 |
| W372PLP-8-6R | 1/2 | 3/8 | 20 | 1.38 | 1.22 |



W372PLP Male Branch Tee - BSPT

| PART NO. | TUBE SIZE MM | BSPT | C HEX MM | H | L/2 |
|----------------|--------------|------|----------|------|------|
| W372PLP-4M-2R | 4 | 1/8 | 10 | 15.5 | 14.0 |
| W372PLP-4M-4R | 4 | 1/4 | 14 | 16.0 | 14.0 |
| W372PLP-6M-2R | 6 | 1/8 | 10 | 17.5 | 16.0 |
| W372PLP-6M-4R | 6 | 1/4 | 14 | 18.0 | 16.0 |
| W372PLP-8M-2R | 8 | 1/8 | 10 | 22.0 | 23.0 |
| W372PLP-8M-4R | 8 | 1/4 | 14 | 21.0 | 23.0 |
| W372PLP-8M-6R | 8 | 3/8 | 17 | 21.0 | 23.0 |
| W372PLP-10M-4R | 10 | 1/4 | 15 | 24.0 | 26.5 |
| W372PLP-10M-6R | 10 | 3/8 | 17 | 24.0 | 26.5 |
| W372PLP-10M-8R | 10 | 1/2 | 21 | 24.0 | 26.5 |
| W372PLP-12M-4R | 12 | 1/4 | 15 | 27.0 | 31.0 |
| W372PLP-12M-6R | 12 | 3/8 | 17 | 27.0 | 31.0 |
| W372PLP-12M-8R | 12 | 1/2 | 21 | 27.0 | 31.0 |
| W372PLP-14M-6R | 14 | 3/8 | 20 | 30.5 | 35.5 |
| W372PLP-14M-8R | 14 | 1/2 | 24 | 28.5 | 35.5 |
| W372PLP-16M-6R | 16 | 3/8 | 27 | 53.0 | 38.5 |
| W372PLP-16M-8R | 16 | 1/2 | 27 | 53.0 | 38.5 |



W372PLP Male Branch Tee - NPT

| PART NO. | TUBE SIZE MM | NPT | C HEX MM | H | L/2 |
|---------------|--------------|-----|----------|------|------|
| W372PLP-4M-2 | 4 | 1/8 | 11 | .61 | .55 |
| W372PLP-4M-4 | 4 | 1/4 | 14 | .63 | .55 |
| W372PLP-6M-2 | 6 | 1/8 | 11 | .69 | .63 |
| W372PLP-6M-4 | 6 | 1/4 | 14 | .71 | .63 |
| W372PLP-8M-2 | 8 | 1/8 | 11 | .87 | .91 |
| W372PLP-8M-4 | 8 | 1/4 | 14 | .83 | .91 |
| W372PLP-8M-6 | 8 | 3/8 | 18 | .85 | .91 |
| W372PLP-10M-4 | 10 | 1/4 | 15 | .98 | 1.04 |
| W372PLP-10M-6 | 10 | 3/8 | 18 | .95 | 1.04 |
| W372PLP-10M-8 | 10 | 1/2 | 22 | .98 | 1.04 |
| W372PLP-12M-6 | 12 | 3/8 | 18 | 1.06 | 1.22 |
| W372PLP-12M-8 | 12 | 1/2 | 22 | .98 | 1.22 |

WARNING These products can expose you to chemicals including NICKEL, which is known to the state of California to cause cancer. For more information go to www.P65Warnings.ca.gov.

[Click here for CADs, Product Specifications or to Configure Parts Online](#)

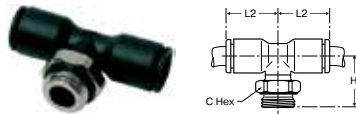

372PLP Male Branch Tee - BSPP

| PART NO. | TUBE SIZE MM | BSPP / M5 | C HEX MM | H | L/2 |
|---------------|--------------|-----------|----------|------|------|
| 372PLP-4M-M5 | 4 | M5X0.8 | 8 | 17.5 | 14.0 |
| 372PLP-4M-2G | 4 | 1/8 | 13 | 15.0 | 14.0 |
| 372PLP-4M-4G | 4 | 1/4 | 16 | 15.0 | 14.0 |
| 372PLP-6M-M5 | 6 | M5X0.8 | 8 | 19.5 | 16.0 |
| 372PLP-6M-2G | 6 | 1/8 | 13 | 17.0 | 16.0 |
| 372PLP-6M-4G | 6 | 1/4 | 16 | 17.0 | 16.0 |
| 372PLP-8M-2G | 8 | 1/8 | 13 | 23.5 | 23.0 |
| 372PLP-8M-4G | 8 | 1/4 | 16 | 21.5 | 23.0 |
| 372PLP-8M-6G | 8 | 3/8 | 20 | 21.5 | 23.0 |
| 372PLP-10M-4G | 10 | 1/4 | 16 | 26.0 | 26.5 |
| 372PLP-10M-6G | 10 | 3/8 | 20 | 24.0 | 26.5 |
| 372PLP-10M-8G | 10 | 1/2 | 24 | 24.0 | 26.5 |
| 372PLP-12M-4G | 12 | 1/4 | 16 | 29.0 | 31.0 |
| 372PLP-12M-6G | 12 | 3/8 | 20 | 27.0 | 31.0 |
| 372PLP-12M-8G | 12 | 1/2 | 24 | 27.0 | 31.0 |
| 372PLP-14M-6G | 14 | 3/8 | 20 | 32.5 | 35.5 |
| 372PLP-14M-8G | 14 | 1/2 | 24 | 27.0 | 35.5 |
| 372PLP-16M-6G | 16 | 3/8 | 27 | 54.5 | 38.5 |
| 372PLP-16M-8G | 16 | 1/2 | 27 | 54.5 | 38.5 |

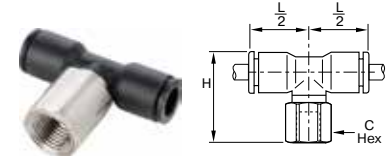

377PLP Female Branch Tee - NPT

| PART NO. | TUBE SIZE IN | THREAD NPT / UNF | C HEX MM | L/2 | H |
|-------------|--------------|------------------|----------|------|------|
| 377PLP-2-2 | 1/8 | 1/8 | 13 | .57 | .99 |
| 377PLP-4M-2 | 5/32 (4MM) | 1/8 | 13 | .55 | .91 |
| 377PLP-4M-4 | 5/32 (4MM) | 1/4 | 16 | .55 | 1.08 |
| 377PLP-4-2 | 1/4 | 1/8 | 13 | .71 | 1.02 |
| 377PLP-4-4 | 1/4 | 1/4 | 16 | .71 | 1.18 |
| 377PLP-8M-2 | 5/16 (8MM) | 1/8 | 13 | .91 | 1.24 |
| 377PLP-8M-4 | 5/16 (8MM) | 1/4 | 16 | .91 | 1.40 |
| 377PLP-6-4 | 3/8 | 1/4 | 16 | 1.04 | 1.60 |
| 377PLP-8-6 | 1/2 | 3/8 | 22 | 1.38 | 1.88 |

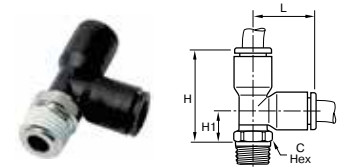

W371PLP Male Run Tee - NPT

| PART NO. | TUBE SIZE IN | THREAD NPT / UNF | C HEX MM | L | H | H1 |
|--------------|--------------|------------------|----------|------|------|-----|
| 371PLP-2-0 | 1/8 | 10-32 | 8 | .57 | .92 | .35 |
| W371PLP-2-1 | 1/8 | 1/16 | 10 | .57 | .93 | .35 |
| W371PLP-2-2 | 1/8 | 1/8 | 11 | .57 | .93 | .35 |
| 371PLP-4M-0 | 5/32 (4MM) | 10-32 | 8 | .57 | 1.02 | .45 |
| W371PLP-4M-2 | 5/32 (4MM) | 1/8 | 11 | .57 | .93 | .53 |
| W371PLP-4M-4 | 5/32 (4MM) | 1/4 | 14 | .57 | .94 | .37 |
| W371PLP-3-2 | 3/16 | 1/8 | 11 | .85 | 1.31 | .45 |
| W371PLP-4-2 | 1/4 | 1/8 | 11 | .69 | 1.16 | .45 |
| W371PLP-4-4 | 1/4 | 1/4 | 14 | .69 | 1.12 | .41 |
| W371PLP-4-6 | 1/4 | 3/8 | 18 | .69 | 1.14 | .43 |
| W371PLP-8M-2 | 5/16 (8MM) | 1/8 | 11 | .91 | 1.38 | .49 |
| W371PLP-8M-4 | 5/16 (8MM) | 1/4 | 14 | .91 | 1.34 | .45 |
| W371PLP-8M-6 | 5/16 (8MM) | 3/8 | 18 | .91 | 1.36 | .47 |
| W371PLP-6-2 | 3/8 | 1/8 | 15 | 1.04 | 1.63 | .60 |
| W371PLP-6-4 | 3/8 | 1/4 | 15 | 1.04 | 1.63 | .60 |
| W371PLP-6-6 | 3/8 | 3/8 | 18 | 1.04 | 1.60 | .55 |
| W371PLP-6-8 | 3/8 | 1/2 | 22 | 1.04 | 1.63 | .59 |
| W371PLP-8-4 | 1/2 | 1/4 | 20 | 1.38 | 2.17 | .79 |
| W371PLP-8-6 | 1/2 | 3/8 | 20 | 1.38 | 2.17 | .79 |
| W371PLP-8-8 | 1/2 | 1/2 | 24 | 1.38 | 2.07 | .79 |

WARNING These products can expose you to chemicals including NICKEL, which is known to the state of California to cause cancer. For more information go to www.P65Warnings.ca.gov.



[Click here for CADs, Product Specifications or to Configure Parts Online](#)

- A
- B
- C
- D
- E
- F
- G
- H
- I
- J
- K
- L
- M
- N
- O

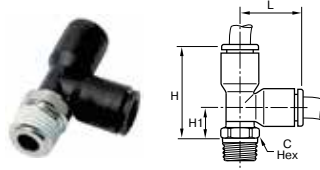

W371PLP Male Run Tee - BSPT

| PART NO. | TUBE SIZE MM | THREAD BSPT | C HEX MM | H | H1 | L |
|----------------|--------------|-------------|----------|------|------|------|
| W371PLP-4M-2R | 4 | 1/8 | 10 | 23.5 | 9.0 | 14.5 |
| W371PLP-4M-4R | 4 | 1/4 | 14 | 24.0 | 9.5 | 14.5 |
| W371PLP-6M-2R | 6 | 1/8 | 10 | 27.5 | 10.0 | 17.5 |
| W371PLP-6M-4R | 6 | 1/4 | 14 | 28.0 | 10.5 | 17.5 |
| W371PLP-8M-2R | 8 | 1/8 | 10 | 35.0 | 12.0 | 23.0 |
| W371PLP-8M-4R | 8 | 1/4 | 14 | 34.0 | 11.0 | 23.0 |
| W371PLP-8M-6R | 8 | 3/8 | 17 | 34.0 | 11.0 | 23.0 |
| W371PLP-10M-4R | 10 | 1/4 | 15 | 40.5 | 14.0 | 26.5 |
| W371PLP-10M-6R | 10 | 3/8 | 17 | 40.5 | 14.0 | 26.5 |
| W371PLP-10M-8R | 10 | 1/2 | 21 | 40.5 | 14.0 | 26.5 |
| W371PLP-12M-4R | 12 | 1/4 | 15 | 46.5 | 15.5 | 31.0 |
| W371PLP-12M-6R | 12 | 3/8 | 17 | 46.5 | 15.5 | 31.0 |
| W371PLP-12M-8R | 12 | 1/2 | 21 | 46.5 | 15.5 | 31.0 |
| W371PLP-14M-8R | 14 | 1/2 | 24 | 52.5 | 17.5 | 35.5 |
| W371PLP-16M-6R | 16 | 3/8 | 27 | 38.5 | 78 | 39.5 |
| W371PLP-16M-8R | 16 | 1/2 | 27 | 38.5 | 78 | 39.5 |

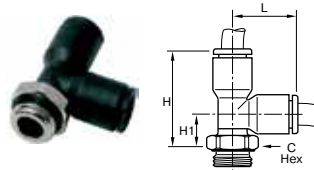

371PLP Male Run Tee - BSPP

| PART NO. | TUBE SIZE MM | BSPP / M5 | C HEX MM | H | H1 | L |
|---------------|--------------|-----------|----------|------|------|------|
| 371PLP-4M-M5 | 4 | M5X0.8 | 8 | 26.0 | 11.5 | 14.5 |
| 371PLP-4M-2G | 4 | 1/8 | 13 | 23.0 | 8.5 | 14.5 |
| 371PLP-4M-4G | 4 | 1/4 | 16 | 23.0 | 8.5 | 14.5 |
| 371PLP-6M-M5 | 6 | M5X0.8 | 8 | 29.5 | 12.5 | 17.5 |
| 371PLP-6M-2G | 6 | 1/8 | 13 | 27.0 | 10.0 | 17.5 |
| 371PLP-6M-4G | 6 | 1/4 | 16 | 27.0 | 10.0 | 17.5 |
| 371PLP-8M-2G | 8 | 1/8 | 13 | 36.5 | 14.0 | 23.0 |
| 371PLP-8M-4G | 8 | 1/4 | 16 | 34.5 | 12.0 | 23.0 |
| 371PLP-8M-6G | 8 | 3/8 | 20 | 34.5 | 12.0 | 23.0 |
| 371PLP-10M-4G | 10 | 1/4 | 16 | 42.0 | 15.5 | 26.5 |
| 371PLP-10M-6G | 10 | 3/8 | 20 | 40.5 | 14.0 | 26.5 |
| 371PLP-10M-8G | 10 | 1/2 | 24 | 40.5 | 14.0 | 26.5 |
| 371PLP-12M-4G | 12 | 1/4 | 16 | 48.0 | 17.0 | 31.0 |
| 371PLP-12M-6G | 12 | 3/8 | 20 | 46.5 | 15.5 | 31.0 |
| 371PLP-12M-8G | 12 | 1/2 | 24 | 46.5 | 15.5 | 31.0 |
| 371PLP-14M-6G | 14 | 3/8 | 20 | 56.5 | 21.5 | 35.5 |
| 371PLP-14M-8G | 14 | 1/2 | 24 | 51.0 | 16.0 | 35.5 |
| 371PLP-16M-6G | 16 | 3/8 | 27 | 38.5 | 79.5 | 41 |
| 371PLP-16M-8G | 16 | 1/2 | 27 | 38.5 | 79.5 | 41 |

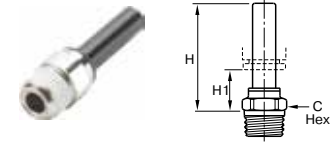

W68PLPSP Male Standpipe - NPT

| PART NO. | TUBE SIZE IN | THREAD NPT / UNF | C HEX MM | H | H1 |
|---------------|--------------|------------------|----------|------|-----|
| 68PLPSP-4M-0 | 5/32 (4MM) | 10-32 | 8 | 1.24 | |
| W68PLPSP-4M-2 | 5/32 (4MM) | 1/8 | 11 | 1.02 | .57 |
| W68PLPSP-4M-4 | 5/32 (4MM) | 1/4 | 14 | 1.04 | .59 |
| W68PLPSP-4-2 | 1/4 | 1/8 | 11 | 1.18 | .61 |
| W68PLPSP-4-4 | 1/4 | 1/4 | 14 | 1.12 | .57 |
| W68PLPSP-8M-2 | 5/16 (8MM) | 1/8 | 11 | 1.16 | .43 |
| W68PLPSP-8M-4 | 5/16 (8MM) | 1/4 | 14 | 1.12 | .39 |
| W68PLPSP-6-2 | 3/8 | 1/8 | 15 | 1.47 | .81 |
| W68PLPSP-6-4 | 3/8 | 1/4 | 15 | 1.42 | .67 |
| W68PLPSP-6-6 | 3/8 | 3/8 | 17 | 1.42 | .61 |
| W68PLPSP-8-6 | 1/2 | 3/8 | 17 | 1.44 | .37 |
| W68PLPSP-8-8 | 1/2 | 1/2 | 21 | 1.46 | .39 |

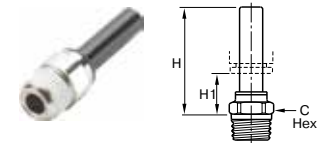

W68PLPSP Male Standpipe - BSPT

| PART NO. | TUBE SIZE MM | BSPT | C HEX MM | H | H1 |
|-----------------|--------------|------|----------|------|------|
| W68PLPSP-4M-2R | 4 | 1/8 | 10 | 26.0 | 14.0 |
| W68PLPSP-4M-4R | 4 | 1/4 | 14 | 26.5 | 14.5 |
| W68PLPSP-6M-2R | 6 | 1/8 | 10 | 28.0 | 14.0 |
| W68PLPSP-6M-4R | 6 | 1/4 | 14 | 28.5 | 14.5 |
| W68PLPSP-8M-2R | 8 | 1/8 | 10 | 29.5 | 11.0 |
| W68PLPSP-8M-4R | 8 | 1/4 | 14 | 28.5 | 10.0 |
| W68PLPSP-10M-4R | 10 | 1/4 | 15 | 36.0 | 15.5 |
| W68PLPSP-10M-6R | 10 | 3/8 | 17 | 36.0 | 15.5 |
| W68PLPSP-10M-8R | 10 | 1/2 | 21 | 36.0 | 15.5 |
| W68PLPSP-12M-6R | 12 | 3/8 | 17 | 36.5 | 12.0 |
| W68PLPSP-12M-8R | 12 | 1/2 | 21 | 36.5 | 12.0 |

WARNING These products can expose you to chemicals including NICKEL, which is known to the state of California to cause cancer. For more information go to www.P65Warnings.ca.gov.



[Click here for CADs, Product Specifications or to Configure Parts Online](#)

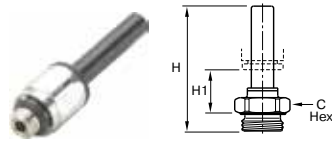

68PLPSP Male Standpipe - BSPP

| PART NO. | TUBE SIZE MM | BSPP | C HEX MM | H | H1 |
|----------------|--------------|--------|----------|------|------|
| 68PLPSP-4M-M5 | 4 | M5X0.8 | 8 | 31.0 | 16.0 |
| 68PLPSP-4M-2G | 4 | 1/8 | 13 | 30.0 | 13.5 |
| 68PLPSP-4M-4G | 4 | 1/4 | 16 | 31.0 | 13.5 |
| 68PLPSP-6M-2G | 6 | 1/8 | 13 | 32.0 | 13.5 |
| 68PLPSP-6M-4G | 6 | 1/4 | 16 | 33.0 | 13.5 |
| 68PLPSP-8M-2G | 8 | 1/8 | 13 | 35.5 | 12.5 |
| 68PLPSP-8M-4G | 8 | 1/4 | 16 | 34.5 | 10.5 |
| 68PLPSP-8M-6G | 8 | 3/8 | 20 | 34.5 | 10.5 |
| 68PLPSP-10M-4G | 10 | 1/4 | 16 | 43.5 | 17.5 |
| 68PLPSP-10M-6G | 10 | 3/8 | 20 | 41.5 | 15.5 |
| 68PLPSP-10M-8G | 10 | 1/2 | 24 | 41.5 | 15.5 |
| 68PLPSP-12M-6G | 12 | 3/8 | 20 | 42.0 | 12.0 |
| 68PLPSP-12M-8G | 12 | 1/2 | 24 | 43.5 | 12.0 |
| 68PLPSP-14M-6G | 14 | 3/8 | 20 | 46.5 | 14.0 |
| 68PLPSP-14M-8G | 14 | 1/2 | 24 | 48.0 | 13.5 |

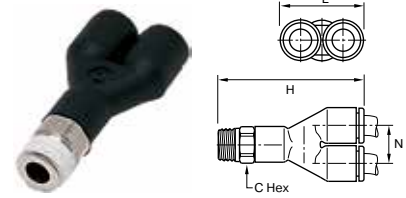

W368PLP Male Y Connector - BSPT

| PART NO. | TUBE SIZE MM | BSPT | C HEX MM | H | L | N |
|----------------|--------------|------|----------|------|------|------|
| W368PLP-4M-2R | 4 | 1/8 | 10 | 32.5 | 17.5 | 9.0 |
| W368PLP-4M-4R | 4 | 1/4 | 14 | 33.0 | 17.5 | 9.0 |
| W368PLP-6M-2R | 6 | 1/8 | 10 | 39.5 | 21.5 | 1.0 |
| W368PLP-6M-4R | 6 | 1/4 | 14 | 40.0 | 21.5 | 1.0 |
| W368PLP-8M-2R | 8 | 1/8 | 13 | 56.5 | 28.0 | 14.5 |
| W368PLP-8M-4R | 8 | 1/4 | 14 | 55.5 | 28.0 | 14.5 |
| W368PLP-8M-6R | 8 | 3/8 | 16 | 48.5 | 28.0 | 14.5 |
| W368PLP-10M-4R | 10 | 1/4 | 14 | 60.0 | 39.0 | 20.0 |
| W368PLP-10M-6R | 10 | 3/8 | 16 | 60.5 | 39.0 | 20.0 |
| W368PLP-10M-8R | 10 | 1/2 | 24 | 61.0 | 39.0 | 20.0 |
| W368PLP-12M-6R | 12 | 3/8 | 19 | 66.0 | 39.0 | 20.0 |
| W368PLP-12M-8R | 12 | 1/2 | 21 | 66.0 | 39.0 | 20.0 |

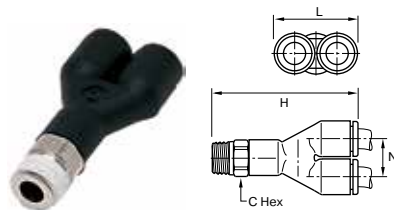

W368PLP Male Y Connector - NPT

| PART NO. | TUBE SIZE IN | THREAD NPT | C HEX MM | H | L | N |
|--------------|--------------|------------|----------|------|------|-----|
| W368PLP-4M-2 | 5/32 (4MM) | 1/8 | 11 | 1.28 | .69 | .35 |
| W368PLP-4M-4 | 5/32 (4MM) | 1/4 | 14 | 1.30 | .69 | .35 |
| W368PLP-4-2 | 1/4 | 1/8 | 11 | 1.61 | .87 | .45 |
| W368PLP-4-4 | 1/4 | 1/4 | 14 | 1.56 | .87 | .45 |
| W368PLP-6-4 | 3/8 | 1/4 | 17 | 2.24 | 1.30 | .67 |
| W368PLP-6-6 | 3/8 | 3/8 | 18 | 2.28 | 1.30 | .67 |

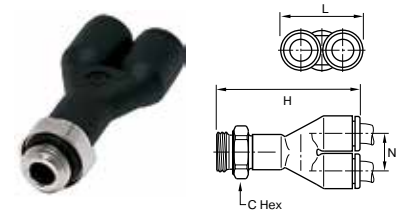

368PLP Male Y Connector - BSPP

| PART NO. | TUBE SIZE MM | BSPP / M5 | C HEX MM | H | L | N |
|---------------|--------------|-----------|----------|------|------|------|
| 368PLP-4M-M5 | 4 | M5X0.8 | 8 | 32.5 | 17.5 | 9.0 |
| 368PLP-4M-2G | 4 | 1/8 | 13 | 32.0 | 17.5 | 9.0 |
| 368PLP-4M-4G | 4 | 1/4 | 16 | 32.0 | 17.5 | 9.0 |
| 368PLP-6M-M5 | 6 | M5X0.8 | 10 | 39.5 | 21.5 | 11.0 |
| 368PLP-6M-2G | 6 | 1/8 | 13 | 39.0 | 21.5 | 11.0 |
| 368PLP-6M-4G | 6 | 1/4 | 16 | 39.0 | 21.5 | 11.0 |
| 368PLP-8M-2G | 8 | 1/8 | 13 | 56.0 | 28.0 | 14.5 |
| 368PLP-8M-4G | 8 | 1/4 | 16 | 55.0 | 28.0 | 14.5 |
| 368PLP-8M-6G | 8 | 3/8 | 19 | 54.0 | 28.0 | 14.5 |
| 368PLP-10M-4G | 10 | 1/4 | 16 | 63.5 | 33.0 | 17.0 |
| 368PLP-10M-6G | 10 | 3/8 | 20 | 63.5 | 33.0 | 17.0 |
| 368PLP-10M-8G | 10 | 1/2 | 20 | 65.0 | 33.0 | 17.0 |
| 368PLP-12M-6G | 12 | 3/8 | 19 | 68.0 | 39.0 | 20.0 |
| 368PLP-12M-8G | 12 | 1/2 | 24 | 70.0 | 39.0 | 20.0 |

WARNING These products can expose you to chemicals including NICKEL, which is known to the state of California to cause cancer. For more information go to www.P65Warnings.ca.gov.

- A
- B
- C
- D
- E
- F
- G
- H
- I
- J
- K
- L
- M
- N
- O

Click here for CADs, Product Specifications or to Configure Parts Online

A

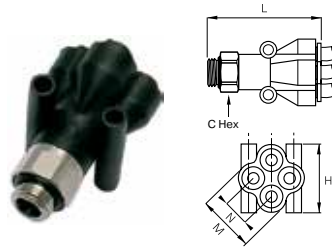

W368PLPD Double Y Male Connector - BSPT

| PART NO. | TUBE SIZE MM | BSPT | C HEX MM | H | L | M | N | MOUNTING HOLE DIA |
|----------------|--------------|------|----------|------|------|------|------|-------------------|
| W368PLPD-4M-2R | 4 | 1/8 | 13 | 25.5 | 41.5 | 21.0 | 10.0 | 3.7 |
| W368PLPD-4M-4R | 4 | 1/4 | 16 | 25.5 | 43.5 | 21.0 | 10.0 | 3.7 |
| W368PLPD-6M-2R | 6 | 1/8 | 19 | 31.5 | 54.5 | 26.5 | 12.0 | 3.7 |
| W368PLPD-6M-4R | 6 | 1/4 | 19 | 31.5 | 57.5 | 26.5 | 12.0 | 3.7 |

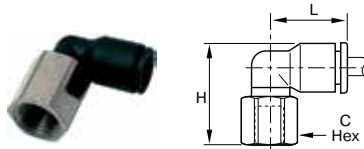

370PLP Female Elbow Swivel - NPT

| PART NO. | TUBE SIZE IN | THREAD NPT | C HEX MM | L | H |
|-------------|--------------|------------|----------|------|------|
| 370PLP-2-2 | 1/8 | 1/8 | 13 | .57 | .91 |
| 370PLP-4M-2 | 5/32 (4MM) | 1/8 | 13 | .55 | .91 |
| 370PLP-4M-4 | 5/32 (4MM) | 1/4 | 16 | .55 | 1.08 |
| 370PLP-4-2 | 1/4 | 1/8 | 13 | .71 | 1.02 |
| 370PLP-4-4 | 1/4 | 1/4 | 16 | .71 | 1.18 |
| 370PLP-8M-2 | 5/16 (8MM) | 1/8 | 13 | .91 | 1.12 |
| 370PLP-8M-4 | 5/16 (8MM) | 1/4 | 16 | .91 | 1.28 |
| 370PLP-6-2 | 3/8 | 1/8 | 16 | 1.04 | 1.52 |
| 370PLP-6-4 | 3/8 | 1/4 | 16 | 1.04 | 1.52 |
| 370PLP-8-6 | 1/2 | 3/8 | 22 | 1.38 | 1.88 |

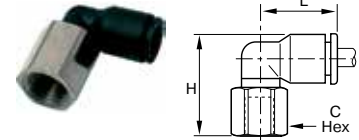

370PLP Female Elbow - BSPP

| PART NO. | TUBE SIZE MM | BSPP | C HEX MM | H | L |
|---------------|--------------|------|----------|------|------|
| 370PLP-4M-2G | 4 | 1/8 | 13 | 23.0 | 14.0 |
| 370PLP-4M-4G | 4 | 1/4 | 16 | 27.0 | 14.0 |
| 370PLP-6M-2G | 6 | 1/8 | 13 | 25.0 | 16.0 |
| 370PLP-6M-4G | 6 | 1/4 | 16 | 29.0 | 16.0 |
| 370PLP-8M-2G | 8 | 1/8 | 13 | 28.0 | 23.0 |
| 370PLP-8M-4G | 8 | 1/4 | 16 | 32.0 | 23.0 |
| 370PLP-8M-6G | 8 | 3/8 | 19 | 33.0 | 23.0 |
| 370PLP-10M-4G | 10 | 1/4 | 16 | 34.5 | 26.5 |
| 370PLP-10M-6G | 10 | 3/8 | 19 | 35.0 | 26.5 |
| 370PLP-10M-8G | 10 | 1/2 | 24 | 41.0 | 26.5 |
| 370PLP-12M-4G | 12 | 1/4 | 16 | 38.0 | 30.5 |
| 370PLP-12M-6G | 12 | 3/8 | 19 | 38.5 | 30.5 |
| 370PLP-12M-8G | 12 | 1/2 | 24 | 43.5 | 30.5 |

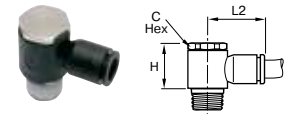

W369PLPBJ Banjo - NPT

| PART NO. | TUBE SIZE IN | THREAD NPT / UNF | C HEX MM | H | L2 |
|----------------|--------------|------------------|----------|------|------|
| 369PLPBJ-2-0 | 1/8 | 10-32 | | .79 | .65 |
| 369PLPBJ-4M-0 | 5/32 (4MM) | 10-32 | | .79 | .65 |
| W369PLPBJ-4M-2 | 5/32 (4MM) | 1/8 | 13 | .73 | .73 |
| 369PLPBJ-4-0 | 1/4 | 10-32 | | .79 | .73 |
| W369PLPBJ-4-2 | 1/4 | 1/8 | 13 | .73 | .83 |
| W369PLPBJ-4-4 | 1/4 | 1/4 | 17 | .89 | .91 |
| W369PLPBJ-4-6 | 1/4 | 3/8 | 21 | 1.04 | 1.12 |
| W369PLPBJ-6-4 | 3/8 | 1/4 | 17 | .89 | 1.12 |
| W369PLPBJ-6-6 | 3/8 | 3/8 | 21 | 1.04 | 1.20 |

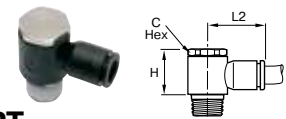

W369PLPBJ Banjo - BSPT

| PART NO. | TUBE SIZE MM | BSPT | C HEX MM | H | L2 |
|------------------|--------------|------|----------|------|------|
| W369PLPBJ-6M-2R | 6 | 1/8 | 13 | 18.5 | 20.0 |
| W369PLPBJ-6M-4R | 6 | 1/4 | 17 | 22.5 | 22.0 |
| W369PLPBJ-8M-2R | 8 | 1/8 | 13 | 18.5 | 25.0 |
| W369PLPBJ-8M-4R | 8 | 1/4 | 17 | 22.5 | 27.0 |
| W369PLPBJ-10M-4R | 10 | 1/4 | 17 | 22.5 | 29.0 |
| W369PLPBJ-10M-6R | 10 | 3/8 | 21 | 26.5 | 31.0 |
| W369PLPBJ-12M-4R | 12 | 1/4 | 21 | 26.5 | 34.5 |
| W369PLPBJ-12M-6R | 12 | 3/8 | 21 | 26.5 | 34.5 |

WARNING These products can expose you to chemicals including NICKEL, which is known to the state of California to cause cancer. For more information go to www.P65Warnings.ca.gov.



B

C

D

E

F

G

H

I

J

K

L

M

N

O

Click here for CADs, Product Specifications or to Configure Parts Online

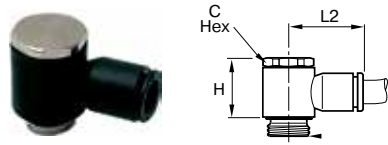

369PLPBJ Banjo - BSPP

| PART NO. | TUBE SIZE MM | BSPP / METRIC | C HEX MM | H | L2 |
|-----------------|--------------|---------------|----------|------|------|
| 369PLPBJ-3M-M3* | 3 | M3X0.5 | | 13.0 | 16.0 |
| 369PLPBJ-4M-M5* | 4 | M5X0.8 | | 13.0 | 16.0 |
| 369PLPBJ-4M-2G | 4 | 1/8 | 13 | 17.0 | 18.5 |
| 369PLPBJ-6M-M5* | 6 | M5X0.8 | | 13.0 | 18.5 |
| 369PLPBJ-6M-2G | 6 | 1/8 | 13 | 17.0 | 20.0 |
| 369PLPBJ-6M-4G | 6 | 1/4 | 17 | 21.0 | 22.0 |
| 369PLPBJ-8M-2G | 8 | 1/8 | 13 | 16.5 | 25.0 |
| 369PLPBJ-8M-4G | 8 | 1/4 | 17 | 21.0 | 27.0 |
| 369PLPBJ-8M-6G | 8 | 3/8 | 20 | 24.5 | 29.0 |
| 369PLPBJ-10M-4G | 10 | 1/4 | 17 | 21.0 | 29.0 |
| 369PLPBJ-10M-6G | 10 | 3/8 | 20 | 24.5 | 31.0 |
| 369PLPBJ-10M-8G | 10 | 1/2 | 25 | 27.5 | 36.5 |
| 369PLPBJ-12M-6G | 12 | 3/8 | 20 | 24.5 | 34.5 |
| 369PLPBJ-12M-8G | 12 | 1/2 | 25 | 27.5 | 36.5 |

*With screwdriver slot

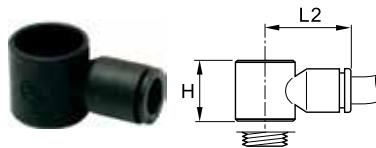

369PLPBJB Banjo Bodies

| PART NO. | TUBE SIZE MM | BSPP / M5 | H | L2 |
|------------------|--------------|-----------|------|------|
| 369PLPBJB-4M-M5 | 4 | M5X0.8 | 13.0 | 16.0 |
| 369PLPBJB-4M-2G | 4 | 1/8 | 14.5 | 18.5 |
| 369PLPBJB-6M-M5 | 6 | M5X0.8 | 13.0 | 18.5 |
| 369PLPBJB-6M-2G | 6 | 1/8 | 14.5 | 20.0 |
| 369PLPBJB-6M-4G | 6 | 1/4 | 18.0 | 22.0 |
| 369PLPBJB-8M-2G | 8 | 1/8 | 14.5 | 25.0 |
| 369PLPBJB-8M-4G | 8 | 1/4 | 18.0 | 27.0 |
| 369PLPBJB-8M-6G | 8 | 3/8 | 21.5 | 29.0 |
| 369PLPBJB-10M-4G | 10 | 1/4 | 18.0 | 29.0 |
| 369PLPBJB-10M-6G | 10 | 3/8 | 21.5 | 31.0 |
| 369PLPBJB-12M-6G | 12 | 3/8 | 21.5 | 34.5 |

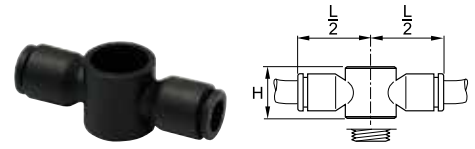

32PLPDJB Double Banjo Bodies

| PART NO. | TUBE SIZE MM | BSPP / M5 | H | L/2 |
|----------------|--------------|-----------|------|------|
| 32PLPDJB-6M-2G | 6 | 1/8 | 14.4 | 20.0 |
| 32PLPDJB-6M-4G | 6 | 1/4 | 18.0 | 26.0 |
| 32PLPDJB-8M-4G | 8 | 1/4 | 18.0 | 27.0 |

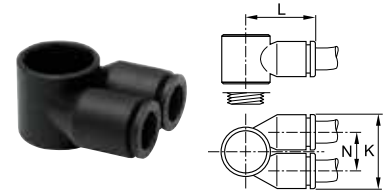

369PLTJB Twin Banjo Bodies

| PART NO. | TUBE SIZE MM | BSPP / M5 | K | L | N |
|----------------|--------------|-----------|------|------|------|
| 369PLTJB-4M-4G | 4 | 1/4 | 28.0 | 25.0 | 14.5 |
| 369PLTJB-6M-2G | 6 | 1/8 | 22.5 | 20.5 | 12.0 |
| 369PLTJB-6M-4G | 6 | 1/4 | 28.0 | 25.0 | 14.5 |
| 369PLTJB-6M-6G | 6 | 3/8 | 33.0 | 28.5 | 17.0 |
| 369PLTJB-8M-4G | 8 | 1/4 | 28.0 | 26.0 | 14.5 |
| 369PLTJB-8M-6G | 8 | 3/8 | 33.0 | 29.5 | 17.0 |

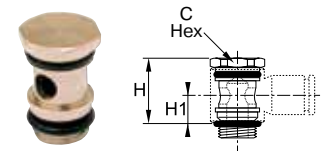

68BJB Single Banjo Bolt

| PART NO. | BSPP / M5 | C HEX MM | H | H1 |
|-----------|-----------|----------|------|------|
| 68BJB-M5* | M5X0.8 | | 17.0 | 7.5 |
| 68BJB-2G | 1/8 | 13 | 17.0 | 7.5 |
| 68BJB-4G | 1/4 | 17 | 21.0 | 9.5 |
| 68BJB-6G | 3/8 | 20 | 24.5 | 11.0 |

*With screwdriver slot

WARNING These products can expose you to chemicals including NICKEL, which is known to the state of California to cause cancer. For more information go to www.P65Warnings.ca.gov.



Click here for CADs, Product Specifications or to Configure Parts Online

- A
- B
- C
- D
- E
- F
- G
- H
- I
- J
- K
- L
- M
- N
- O

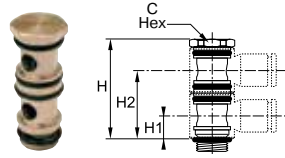

68BJBD Double Banjo Bolt

| PART NO. | BSPP / M5 | C HEX MM | H | H1 | H2 |
|------------|-----------|----------|------|------|------|
| 68BJBD-M5* | M5X0.8 | | 24.5 | 7.5 | 18.5 |
| 68BJBD-2G | 1/8 | 13 | 31.0 | 7.5 | 22.0 |
| 68BJBD-4G | 1/4 | 17 | 39.0 | 9.5 | 27.5 |
| 68BJBD-6G | 3/8 | 20 | 46.0 | 11.0 | 32.5 |

*With screwdriver slot

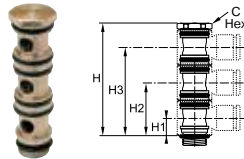

68BJBT Triple Banjo Bolt

| PART NO. | BSPP | C HEX MM | H | H1 | H2 | H3 |
|-----------|------|----------|------|------|------|------|
| 68BJBT-2G | 1/8 | 13 | 45.5 | 7.5 | 22.0 | 36.0 |
| 68BJBT-4G | 1/4 | 17 | 54.0 | 9.5 | 27.5 | 45.5 |
| 68BJBT-6G | 3/8 | 20 | 67.5 | 11.0 | 32.5 | 54.0 |

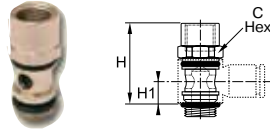

66BJB Female Threaded Banjo Bolt

| PART NO. | 1 BSPP / M5 | 2 BSPP / M5 | C HEX MM | H | H1 |
|----------|-------------|-------------|----------|------|------|
| 66BJB-2G | 1/8 | 1/8 | 13 | 24.5 | 7.5 |
| 66BJB-4G | 1/4 | 1/4 | 17 | 33.0 | 9.5 |
| 66BJB-6G | 3/8 | 3/8 | 20 | 37.5 | 11.0 |
| 66BJB-8G | 1/2 | 1/2 | 25 | 42.0 | 11.5 |

*With screwdriver slot

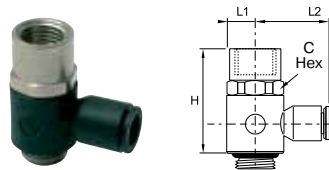

376PLPBJ Banjo with Female Bolt

| PART NO. | TUBE SIZE MM | BSPP / M5 | C HEX MM | H | L1 | L2 |
|----------------|--------------|-----------|----------|------|-----|------|
| 376PLPBJ-4M-2G | 4 | 1/8 | 13 | 25.5 | 7.0 | 18.5 |
| 376PLPBJ-6M-4G | 6 | 1/4 | 17 | 33.0 | 9.0 | 22.0 |
| 376PLPBJ-8M-6G | 8 | 3/8 | 20 | 37.5 | 11 | 29.0 |

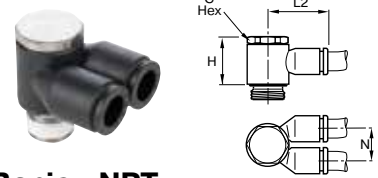

W369PLPTJ Twin Banjo - NPT

| PART NO. | TUBE SIZE IN | THREAD NPT / UNF | C HEX MM | H | L2 |
|----------------|--------------|------------------|----------|------|------|
| 369PLPTJ-4M-0 | 5/32 (4MM) | 10-32 | | .63 | .61 |
| W369PLPTJ-4M-2 | 5/32 (4MM) | 1/8 | 13 | .73 | .73 |
| W369PLPTJ-4-2 | 1/4 | 1/8 | 13 | .73 | .73 |
| W369PLPTJ-4-4 | 1/4 | 1/4 | 17 | .89 | 1.04 |
| W369PLPTJ-6-4 | 3/8 | 1/4 | 21 | 1.04 | 1.22 |
| W369PLPTJ-6-6 | 3/8 | 3/8 | 21 | 1.04 | 1.22 |

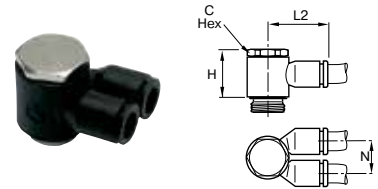

369PLPTJ Twin Banjo - BSPP, M5

| PART NO. | TUBE SIZE MM | BSPP / M5 | C HEX MM | H | L2 | N |
|-----------------|--------------|-----------|----------|------|------|------|
| 369PLPTJ-4M-M5 | 4 | M5X0.8 | | 13.0 | 16.0 | 9.0 |
| 369PLPTJ-4M-2G | 4 | 1/8 | 13 | 16.5 | 18.5 | 11.5 |
| 369PLPTJ-6M-2G | 6 | 1/8 | 13 | 16.5 | 18.5 | 11.5 |
| 369PLPTJ-6M-4G | 6 | 1/4 | 17 | 21.0 | 27.0 | 14.5 |
| 369PLPTJ-8M-4G | 8 | 1/4 | 17 | 21.0 | 27.0 | 14.5 |
| 369PLPTJ-8M-6G | 8 | 3/8 | 20 | 24.5 | 31.0 | 17.0 |
| 369PLPTJ-10M-6G | 10 | 3/8 | 20 | 24.5 | 31.0 | 17.0 |

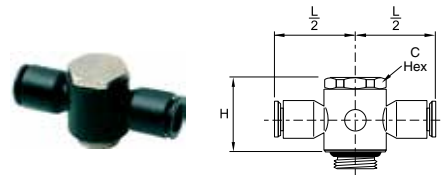

32PLPDJ Double Banjo - BSPP, M5

| PART NO. | TUBE SIZE MM | BSPP / M5 | C HEX MM | H | L/2 |
|---------------|--------------|-----------|----------|------|------|
| 32PLPDJ-4M-M5 | 4 | M5X0.8 | | 13.0 | 16.0 |
| 32PLPDJ-6M-2G | 6 | 1/8 | 13 | 17.0 | 20.0 |
| 32PLPDJ-6M-4G | 6 | 1/4 | 17 | 21.0 | 26.5 |
| 32PLPDJ-8M-4G | 8 | 1/4 | 17 | 21.0 | 27.0 |
| 32PLPDJ-8M-6G | 8 | 3/8 | 20 | 24.5 | 30.5 |

WARNING These products can expose you to chemicals including NICKEL, which is known to the state of California to cause cancer. For more information go to www.P65Warnings.ca.gov.



[Click here for CADs, Product Specifications or to Configure Parts Online](#)

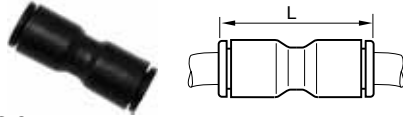

32PLP Equal Union

| PART NO. | TUBE SIZE IN | L |
|----------|--------------|------|
| 32PLP-2 | 1/8 | .97 |
| 32PLP-3 | 3/16 | 1.44 |
| 32PLP-4 | 1/4 | 1.16 |
| 32PLP-6 | 3/8 | 1.65 |
| 32PLP-8 | 1/2 | 2.17 |

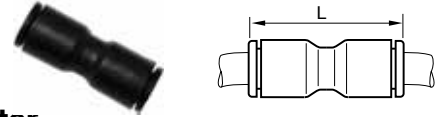

32PLP Converter

| PART NO. | TUBE SIZE IN | TUBE SIZE MM | L |
|-------------|--------------|--------------|------|
| 32PLP-6M-4 | 1/4 | 6 | 1.18 |
| 32PLP-10M-6 | 3/8 | 10 | 1.99 |
| 32PLP-12M-8 | 1/2 | 12 | 2.25 |

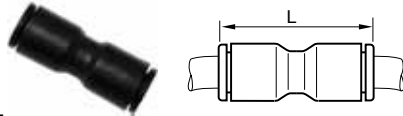

32PLP Unequal Union

| PART NO. | 1 TUBE SIZE IN | 2 TUBE SIZE IN | L |
|------------|----------------|----------------|------|
| 32PLP-4M-2 | 5/32 (4M) | 1/8 | 0.96 |
| 32PLP-4M-4 | 5/32 (4M) | 1/4 | 1.16 |
| 32PLP-4-2 | 1/4 | 1/8 | 1.32 |
| 32PLP-4-8M | 1/4 | 5/16 (8M) | 1.44 |
| 32PLP-6-4 | 3/8 | 1/4 | 1.61 |
| 32PLP-6-8 | 3/8 | 1/2 | 2.17 |

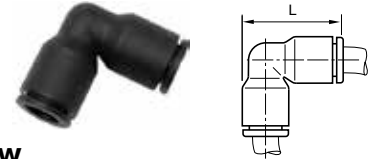

365PLP Union Elbow

| PART NO. | TUBE SIZE IN | L |
|----------|--------------|------|
| 365PLP-2 | 1/8 | .71 |
| 365PLP-3 | 3/16 | 1.07 |
| 365PLP-4 | 1/4 | .93 |
| 365PLP-6 | 3/8 | 1.33 |
| 365PLP-8 | 1/2 | 1.38 |

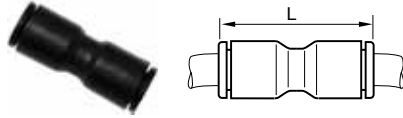

32PLP Union

| PART NO. | TUBE SIZE MM | L |
|-----------|--------------|------|
| 32PLP-3M | 3 | 25.0 |
| 32PLP-4M | 4 | 25.0 |
| 32PLP-6M | 6 | 28.5 |
| 32PLP-8M | 8 | 38.0 |
| 32PLP-10M | 10 | 42.0 |
| 32PLP-12M | 12 | 50.5 |
| 32PLP-14M | 14 | 56.0 |
| 32PLP-16M | 16 | 60.5 |



365PLP Unequal Union Elbow

| PART NO. | 1 TUBE SIZE IN | 2 TUBE SIZE IN | L | H |
|-------------|----------------|----------------|------|------|
| 365PLP-2-4 | 1/8 | 1/4 | .93 | .93 |
| 365PLP-4M-4 | 5/32 (4M) | 1/4 | .93 | .93 |
| 365PLP-6-4 | 3/8 | 1/4 | 1.33 | 1.30 |
| 365PLP-6-8 | 3/8 | 1/2 | 1.81 | 1.81 |

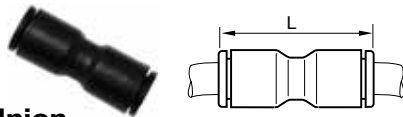

32PLP Unequal Union

| PART NO. | 1 TUBE SIZE MM | 2 TUBE SIZE MM | L |
|---------------|----------------|----------------|------|
| 32PLP-3M-4M | 3 | 4 | 25.0 |
| 32PLP-6M-4M | 6 | 4 | 28.0 |
| 32PLP-8M-4M | 8 | 4 | 28.0 |
| 32PLP-8M-6M | 8 | 6 | 38.0 |
| 32PLP-10M-6M | 10 | 6 | 42.0 |
| 32PLP-10M-8M | 10 | 8 | 42.0 |
| 32PLP-12M-8M | 12 | 8 | 50.5 |
| 32PLP-12M-10M | 12 | 10 | 50.5 |
| 32PLP-12M-14M | 12 | 14 | 56.0 |
| 32PLP-12M-16M | 16 | 12 | 61.0 |

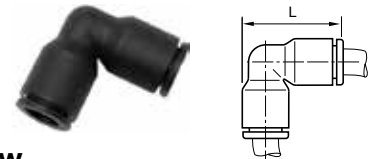

365PLP Union Elbow

| PART NO. | TUBE SIZE MM | L |
|------------|--------------|------|
| 365PLP-4M | 4 | 19.0 |
| 365PLP-6M | 6 | 22.5 |
| 365PLP-8M | 8 | 29.5 |
| 365PLP-10M | 10 | 34.5 |
| 365PLP-12M | 12 | 40.5 |
| 365PLP-14M | 14 | 46.5 |
| 365PLP-16M | 16 | 52.0 |

WARNING These products can expose you to chemicals including NICKEL, which is known to the state of California to cause cancer. For more information go to www.P65Warnings.ca.gov.



- A
- B
- C
- D
- E
- F
- G
- H
- I
- J
- K
- L
- M
- N
- O

Click here for CADs, Product Specifications or to Configure Parts Online

- A
- B
- C
- D
- E
- F
- G
- H
- I
- J
- K
- L
- M
- N
- O



365PLP Unequal Union Elbow

| PART NO. | 1 TUBE SIZE MM | 2 TUBE SIZE MM | L |
|----------------|----------------|----------------|------|
| 365PLP-4M-6M | 4 | 6 | 22.5 |
| 365PLP-6M-8M | 6 | 8 | 29.5 |
| 365PLP-8M-10M | 8 | 10 | 34.5 |
| 365PLP-10M-12M | 10 | 12 | 40.5 |



364PLP Unequal Union Tee

| PART NO. | 1 TUBE SIZE MM | 2 TUBE SIZE MM | H | L/2 |
|----------------|----------------|----------------|------|------|
| 364PLP-4M-6M | 4 | 6 | 22.5 | 17.5 |
| 364PLP-6M-4M | 6 | 4 | 22.5 | 17.5 |
| 364PLP-6M-8M | 6 | 8 | 29.5 | 23.0 |
| 364PLP-8M-6M | 8 | 6 | 29.5 | 23.0 |
| 364PLP-8M-10M | 8 | 10 | 34.5 | 26.5 |
| 364PLP-10M-12M | 10 | 12 | 34.5 | 26.5 |
| 364PLP-10M-8M | 10 | 8 | 40.5 | 31.0 |
| 364PLP-12M-10M | 12 | 10 | 40.5 | 31.0 |
| 364PLP-14M-8M | 14 | 8 | 46.0 | 35.5 |
| 364PLP-16M-12M | 16 | 12 | 39.0 | |

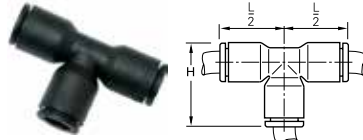

364PLP Union Tee

| PART NO. | TUBE SIZE IN | L/2 | H |
|----------|--------------|------|------|
| 364PLP-2 | 1/8 | .57 | .75 |
| 364PLP-3 | 3/16 | .85 | 1.07 |
| 364PLP-4 | 1/4 | .71 | .92 |
| 364PLP-6 | 3/8 | 1.02 | 1.34 |
| 364PLP-8 | 1/2 | 1.38 | 1.81 |

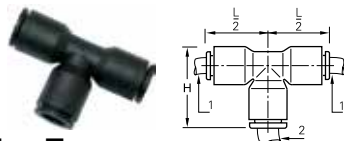

364PLP Unequal Union Tee

| PART NO. | 1 TUBE SIZE IN | 2 TUBE SIZE IN | L/2 | H |
|-------------|----------------|----------------|------|------|
| 364PLP-2-4 | 1/8 | 1/4 | .71 | .93 |
| 364PLP-4M-4 | 5/32 (4MM) | 1/4 | .71 | .93 |
| 364PLP-4-2 | 1/4 | 1/8 | .73 | .93 |
| 364PLP-4-4M | 1/4 | 5/32 (4MM) | .73 | .93 |
| 364PLP-4-6 | 1/4 | 3/8 | .96 | 1.32 |
| 364PLP-6-4 | 3/8 | 1/4 | 1.00 | 1.28 |
| 364PLP-6-8 | 3/8 | 1/2 | 1.38 | 1.81 |
| 364PLP-8-4 | 1/2 | 1/4 | 1.38 | 1.81 |
| 364PLP-8-6 | 1/2 | 3/8 | 1.38 | 1.81 |



362PLP Union Y

| PART NO. | 1 TUBE SIZE IN | 2 TUBE SIZE IN | L | H | N |
|-------------|----------------|----------------|------|------|-----|
| 362PLP-2 | 1/8 | 1/8 | 1.12 | .69 | .35 |
| 362PLP-2-4 | 1/8 | 1/4 | 1.42 | .87 | .45 |
| 362PLP-4M-4 | 5/32 (4MM) | 1/4 | 1.42 | .87 | .45 |
| 362PLP-4 | 1/4 | 1/4 | 1.42 | .87 | .45 |
| 362PLP-4-6 | 1/4 | 3/8 | 2.02 | 1.30 | .67 |
| 362PLP-6 | 3/8 | 3/8 | 2.09 | 1.30 | .67 |
| 362PLP-8 | 1/2 | 1/2 | 2.64 | 1.77 | .91 |

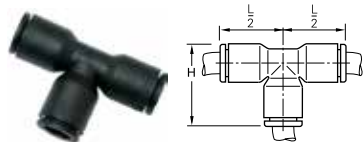

364PLP Union Tee

| PART NO. | TUBE SIZE MM | H | L/2 |
|------------|--------------|------|------|
| 364PLP-3M | 3 | 19.0 | 14.5 |
| 364PLP-4M | 4 | 19.0 | 14.5 |
| 364PLP-6M | 6 | 23.5 | 18.0 |
| 364PLP-8M | 8 | 29.5 | 23.0 |
| 364PLP-10M | 10 | 34.5 | 26.5 |
| 364PLP-12M | 12 | 40.5 | 31.0 |
| 364PLP-14M | 14 | 46.0 | 35.5 |
| 364PLP-16M | 16 | 52.0 | 39.0 |

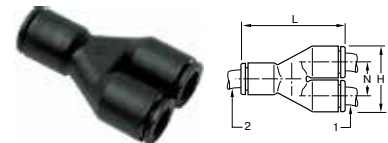

362PLP Union Y

| PART NO. | 1 TUBE SIZE MM | 2 TUBE SIZE (M) | H | L | N |
|----------------|----------------|-----------------|------|------|------|
| 362PLP-4M | 4 | 4 | 17.5 | 28.5 | 9.0 |
| 362PLP-6M | 6 | 6 | 21.5 | 35.0 | 11.0 |
| 362PLP-8M | 8 | 8 | 28.0 | 45.0 | 14.5 |
| 362PLP-10M | 10 | 10 | 33.0 | 53.0 | 17.0 |
| 362PLP-12M | 12 | 12 | 39.0 | 57.0 | 20.0 |
| 362PLP-4M-6M | 4 | 6 | 17.5 | 33.0 | 9.0 |
| 362PLP-6M-8M | 6 | 8 | 22.5 | 41.0 | 11.5 |
| 362PLP-8M-10M | 8 | 10 | 28.0 | 47.0 | 14.5 |
| 362PLP-10M-12M | 10 | 12 | 33.0 | 57.0 | 17.0 |

WARNING These products can expose you to chemicals including NICKEL, which is known to the state of California to cause cancer. For more information go to www.P65Warnings.ca.gov.



Click here for CADs, Product Specifications or to Configure Parts Online

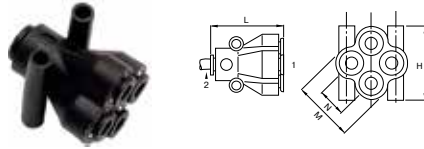

362PLPD Double Y Connector

| PART NO. | 1 TUBE SIZE IN | 2 TUBE SIZE IN | H | L | M | N | MOUNTING HOLE DIA. |
|--------------|----------------|----------------|------|------|-----|-----|--------------------|
| 362PLPD-4M-4 | 5/32 (4MM) | 1/4 | 1.00 | 1.18 | .83 | .39 | .15 |

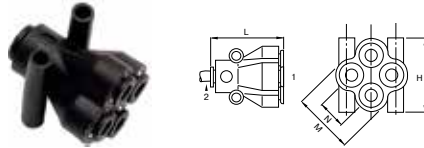

362PLPD Double Y Connector

| PART NO. | 1 TUBE SIZE MM | 2 TUBE SIZE MM | H | L | M | N | MOUNTING HOLE DIA. |
|---------------|----------------|----------------|------|------|------|------|--------------------|
| 362PLPD-4M | 4 | 4 | 25.5 | 30.5 | 21.0 | 10.0 | 3.7 |
| 362PLPD-6M | 6 | 6 | 31.5 | 37.5 | 26.5 | 12.0 | 3.7 |
| 362PLPD-4M-6M | 4 | 6 | 25.5 | 30.5 | 21.0 | 10.0 | 3.7 |
| 362PLPD-6M-8M | 6 | 8 | 31.5 | 38.0 | 26.5 | 12.0 | 3.7 |



32PLPBH Bulkhead Union

| PART NO. | TUBE SIZE IN | C HEX MM | K MAX | L1 | L2 | BULKHEAD THREAD | BULKHEAD HOLE DIA. |
|-----------|--------------|----------|-------|-----|------|-----------------|--------------------|
| 32PLPBH-2 | 1/8 | 13 | .22 | .37 | .61 | M10 X 1 | 12MM |
| 32PLPBH-4 | 1/4 | 16 | .35 | .37 | .81 | M15 X 1 | 16MM |
| 32PLPBH-6 | 3/8 | 22 | .57 | .51 | 1.18 | M18 X 1.5 | 24MM |
| 32PLPBH-8 | 1/2 | 29 | .81 | .67 | 1.61 | M25 X 1.5 | 26MM |



32PLPBH Bulkhead Union

| PART NO. | TUBE SIZE MM | C HEX MM | K MAX | L1 | L2 | BULKHEAD THREAD | BULKHEAD HOLE DIA. |
|-------------|--------------|----------|-------|------|------|-----------------|--------------------|
| 32PLPBH-4M | 4 | 13 | 5.5 | 15.0 | 10.0 | M12 X 1 | 12MM |
| 32PLPBH-6M | 6 | 15 | 8.5 | 18.0 | 10.5 | M14 X 1 | 14MM |
| 32PLPBH-8M | 8 | 18 | 14.5 | 25.0 | 13.5 | M16 X 1 | 16MM |
| 32PLPBH-10M | 10 | 22 | 14.5 | 27.5 | 15.5 | M22 X 1.5 | 22MM |
| 32PLPBH-12M | 12 | 26 | 18.5 | 33.0 | 18.0 | M24 X 1.5 | 24MM |
| 32PLPBH-14M | 14 | 29 | 20.5 | 37.5 | 20.5 | M26 X 1.5 | 26MM |

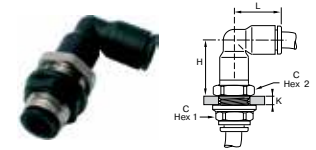

365PLPBH Equal Bulkhead Elbow

| PART NO. | TUBE SIZE IN | C1 HEX | C2 HEX | K MAX | H | L | BULKHEAD THREAD | BHD HOLE DIA. |
|-------------|--------------|--------|--------|-------|------|------|-----------------|---------------|
| 365PLPBH-2 | 1/8 | 13 | 13 | .28 | .71 | .57 | M10 X 1 | 10MM |
| 365PLPBH-4M | 5/32(4MM) | | 13 | .26 | .83 | .67 | M12 X 1 | 12MM |
| 365PLPBH-4 | 1/4 | 18 | 17 | .32 | .87 | .71 | M15 X 1 | 15MM |
| 365PLPBH-8M | 5/16(8MM) | | 18 | .31 | 1.22 | .94 | M16 X 1 | 16MM |
| 365PLPBH-6 | 3/8 | 22 | 22 | .33 | 1.08 | 1.00 | M18 X 1.5 | 18MM |
| 365PLPBH-8 | 1/2 | 29 | 27 | .41 | 1.54 | 1.38 | M25 X 1.5 | 25MM |

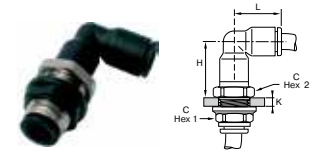

365PLPBH Equal Bulkhead Elbow

| PART NO. | TUBE SIZE MM | C1 HEX | C2 HEX | K MAX | H | L | BULKHEAD THREAD | BULKHEAD HOLE DIA. |
|--------------|--------------|--------|--------|-------|------|------|-----------------|--------------------|
| 365PLPBH-4M | 4 | 13 | 13 | 6.5 | 21.0 | 17.0 | M12 X 1 | 12MM |
| 365PLPBH-6M | 6 | 15 | 15 | 7.0 | 24.5 | 19.5 | M14 X 1 | 14MM |
| 365PLPBH-8M | 8 | 18 | 18 | 8.0 | 31.0 | 24.0 | M16 X 1 | 16MM |
| 365PLPBH-10M | 10 | 22 | 22 | 8.5 | 36.0 | 28.0 | M22 X 1.5 | 22MM |
| 365PLPBH-12M | 12 | 26 | 26 | 8.5 | 42.0 | 33.0 | M24 X 1.5 | 24MM |

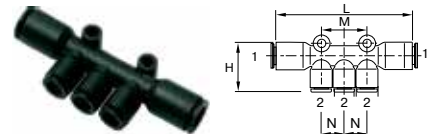

24PLP Multiple Tee

| PART NO. | 1 TUBE SIZE IN | 2 TUBE SIZE IN | H | L | M | N | MTG HOLE DIA. |
|------------|----------------|----------------|------|------|------|-----|---------------|
| 24PLP-4-4M | 1/4 | 5/32(4MM) | 0.97 | 2.81 | .90 | .45 | .17 |
| 24PLP-4-4 | 1/4 | 1/4 | 1.22 | 3.14 | 1.21 | .61 | .17 |
| 24PLP-6-4 | 3/8 | 1/4 | 1.34 | 3.21 | 1.22 | .61 | .17 |

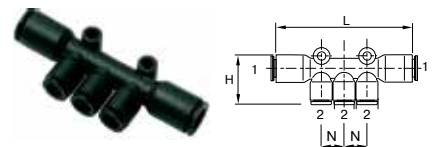

24PLP Multiple Tee

| PART NO. | 1 TUBE SIZE MM | 2 TUBE SIZE (M) | H | L | N | MOUNTING HOLE DIA. |
|--------------|----------------|-----------------|------|----|------|--------------------|
| 24PLP-6M-4M | 6 | 4 | 24.5 | 74 | 11.5 | 4.2 |
| 24PLP-8M-4M | 8 | 4 | 24.5 | 74 | 11.5 | 4.2 |
| 24PLP-8M-6M | 8 | 6 | 24.5 | 74 | 11.5 | 4.2 |
| 24PLP-10M-6M | 10 | 6 | 36.0 | 81 | 15.5 | 4.2 |
| 24PLP-10M-8M | 10 | 8 | 36.0 | 81 | 15.5 | 4.2 |

WARNING These products can expose you to chemicals including NICKEL, which is known to the state of California to cause cancer. For more information go to www.P65Warnings.ca.gov.



Click here for CADs, Product Specifications or to Configure Parts Online

- A
- B
- C
- D
- E
- F
- G
- H
- I
- J
- K
- L
- M
- N
- O

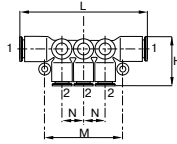

24PLPD Double Multiple Tee

| PART NO. | 1 TUBE SIZE IN | 2 TUBE SIZE IN | H | L | M | N | MOUNTING HOLE DIA. |
|-------------|----------------|----------------|-----|------|------|-----|--------------------|
| 24PLPD-4-4M | 1/4 | 5/32(4MM) | .73 | 2.84 | 1.69 | .45 | .17 |
| 24PLPD-4-4 | 1/4 | 1/4 | .73 | 2.84 | 1.69 | .45 | .17 |
| 24PLPD-6-4 | 3/8 | 1/4 | .91 | 3.31 | 2.05 | .57 | .17 |

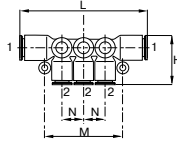

24PLPD Double Multiple Tee

| PART NO. | 1 TUBE SIZE MM | 2 TUBE SIZE MM | H | L | M | N | MOUNTING HOLE DIA. |
|---------------|----------------|----------------|------|------|------|------|--------------------|
| 24PLPD-6M-4M | 6 | 4 | 18.5 | 72.0 | 43.0 | 11.5 | 4.2 |
| 24PLPD-8M-4M | 8 | 4 | 18.5 | 73.0 | 43.0 | 11.5 | 4.2 |
| 24PLPD-8M-6M | 8 | 6 | 18.5 | 73.0 | 43.0 | 11.5 | 4.2 |
| 24PLPD-10M-6M | 10 | 6 | 23.0 | 84.0 | 52.0 | 14.5 | 4.2 |
| 24PLPD-10M-8M | 10 | 8 | 23.5 | 84.0 | 52.0 | 14.5 | 4.2 |

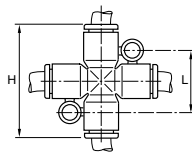

347PLP Equal Cross

| PART NO. | TUBE SIZE IN | H | L | MOUNTING HOLE DIA. |
|----------|--------------|------|-----|--------------------|
| 347PLP-4 | 1/4 | 1.40 | .79 | .17 |

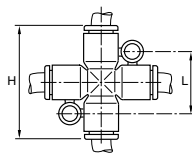

347PLP Equal Cross

| PART NO. | TUBE SIZE MM | H | L | MOUNTING HOLE DIA. |
|-----------|--------------|----|------|--------------------|
| 347PLP-4M | 4 | 36 | 20.0 | 4.2 |
| 347PLP-6M | 6 | 36 | 20.0 | 4.2 |
| 347PLP-8M | 8 | 46 | 22.5 | 4.2 |

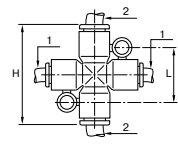

347PLP Unequal Cross

| PART NO. | 1 TUBE SIZE MM | 2 TUBE SIZE MM | H | L | MOUNTING HOLE DIA. |
|---------------|----------------|----------------|----|------|--------------------|
| 347PLP-4M-6M | 4 | 6 | 36 | 20.0 | 4.2 |
| 347PLP-6M-4M* | 6 | 4 | 36 | 20.0 | 4.2 |
| 347PLP-6M-8M | 6 | 8 | 46 | 22.5 | 4.2 |
| 347PLP-8M-6M* | 8 | 6 | 46 | 22.5 | 4.2 |

*This model provides 3 outlets of "TUBE1" and 1 outlet of "TUBE 2".

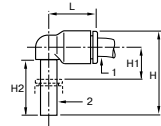

369PLPSP Plug-In Elbow

| PART NO. | 1 TUBE SIZE IN | 2 TUBE SIZE IN | H | H1 | H2 | L |
|---------------|----------------|----------------|------|-----|------|------|
| 369PLPSP-2 | 1/8 | 1/8 | .92 | .31 | .64 | .57 |
| 369PLPSP-4M-4 | 5/32(4MM) | 1/4 | 1.08 | .30 | .71 | .71 |
| 369PLPSP-4 | 1/4 | 1/4 | 1.20 | .43 | .83 | .73 |
| 369PLPSP-4-6 | 1/4 | 3/8 | 1.52 | .35 | .96 | .98 |
| 369PLPSP-6 | 3/8 | 3/8 | 1.52 | .35 | .96 | 1.02 |
| 369PLPSP-8 | 1/2 | 1/2 | 2.00 | .51 | 1.12 | 1.38 |

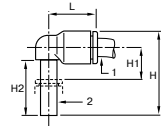

369PLPSP Plug-In Elbow

| PART NO. | 1 TUBE SIZE MM | 2 TUBE SIZE MM | H | H1 | H2 | L |
|------------------|----------------|----------------|------|------|------|------|
| 369PLPSP-4M | 4 | 4 | 23.0 | 6.0 | 15.5 | 14.0 |
| 369PLPSP-6M | 6 | 6 | 26.5 | 7.0 | 17.0 | 16.0 |
| 369PLPSP-8M | 8 | 8 | 33.5 | 8.0 | 21.5 | 23.0 |
| 369PLPSP-10M | 10 | 10 | 39.0 | 9.5 | 24.5 | 23.5 |
| 369PLPSP-12M | 12 | 12 | 44.5 | 10.0 | 27.5 | 31.0 |
| 369PLPSP-4M-6M | 4 | 6 | 26.5 | 7.0 | 17.0 | 16.0 |
| 369PLPSP-6M-4M | 6 | 4 | 24.5 | 7.0 | 15.5 | 16.0 |
| 369PLPSP-6M-8M | 6 | 8 | 33.5 | 8.0 | 21.5 | 22.0 |
| 369PLPSP-8M-10M | 8 | 10 | 39.0 | 8.5 | 24.5 | 26.5 |
| 369PLPSP-10M-12M | 10 | 12 | 44.5 | 10.0 | 27.5 | 31.0 |

WARNING These products can expose you to chemicals including NICKEL, which is known to the state of California to cause cancer. For more information go to www.P65Warnings.ca.gov.

[Click here for CADs, Product Specifications or to Configure Parts Online](#)



369PLPSPX Extended Plug-In Elbow

| PART NO. | 1 TUBE SIZE IN | 2 TUBE SIZE IN | H | H1 | H2 | L |
|-------------|----------------|----------------|------|------|------|------|
| 369PLPSPX-2 | 1/8 | 1/8 | 1.26 | .65 | .98 | .57 |
| 369PLPSPX-4 | 1/4 | 1/4 | 1.56 | .77 | 1.18 | .71 |
| 369PLPSPX-6 | 3/8 | 3/8 | 2.19 | 1.02 | 1.63 | 1.02 |

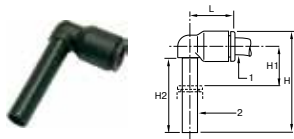

369PLPSPX Extended Plug-In Elbow

| PART NO. | 1 TUBE SIZE MM | 2 TUBE SIZE MM | H | H1 | H2 | L |
|-------------------|----------------|----------------|------|------|------|------|
| 369PLPSPX-4M | 4 | 4 | 32.5 | 15.5 | 25.0 | 14.0 |
| 369PLPSPX-6M | 6 | 6 | 38.5 | 19.0 | 29.0 | 16.0 |
| 369PLPSPX-8M | 8 | 8 | 49.0 | 23.5 | 37.0 | 23.0 |
| 369PLPSPX-10M | 10 | 10 | 56.0 | 26.5 | 41.5 | 26.5 |
| 369PLPSPX-12M | 12 | 12 | 62.5 | 28.0 | 45.5 | 31.0 |
| 369PLPSPX-4M-6M | 4 | 6 | 38.5 | 19.0 | 29.0 | 16.0 |
| 369PLPSPX-6M-8M | 6 | 8 | 49.0 | 23.5 | 37.0 | 23.0 |
| 369PLPSPX-8M-10M | 8 | 10 | 56.0 | 26.5 | 41.5 | 26.5 |
| 369PLPSPX-10M-12M | 10 | 12 | 62.5 | 28.0 | 45.5 | 31.0 |

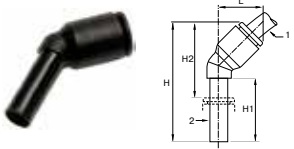

379PLPSP 45° Plug-In Elbow

| PART NO. | 1 TUBE SIZE IN | 2 TUBE SIZE IN | H | H1 | H2 | L |
|------------|----------------|----------------|------|-----|------|-----|
| 379PLPSP-2 | 1/8 | 1/8 | 1.14 | .59 | .69 | .47 |
| 379PLPSP-4 | 1/4 | 1/4 | 1.44 | .71 | .87 | .57 |
| 379PLPSP-6 | 3/8 | 3/8 | 2.00 | .96 | 1.16 | .91 |

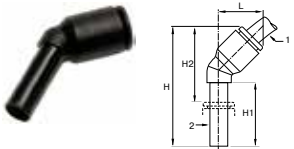

379PLPSP 45° Plug-In Elbow

| PART NO. | 1 TUBE SIZE MM | 2 TUBE SIZE MM | H | H1 | H2 | L |
|--------------|----------------|----------------|------|------|------|------|
| 379PLPSP-4M | 4 | 4 | 33.5 | 19.0 | 21.0 | 13.0 |
| 379PLPSP-6M | 6 | 6 | 39.0 | 21.0 | 25.0 | 14.5 |
| 379PLPSP-8M | 8 | 8 | 44.0 | 21.5 | 25.5 | 19.5 |
| 379PLPSP-10M | 10 | 10 | 53.0 | 27.0 | 32.5 | 23.0 |
| 379PLPSP-12M | 12 | 12 | 58.5 | 27.5 | 34.0 | 26.5 |



372PLPSP Plug-In Branch Tee

| PART NO. | 1 TUBE SIZE IN | 2 TUBE SIZE IN | H | H1 | H2 | L/2 |
|------------|----------------|----------------|------|-----|------|------|
| 372PLPSP-2 | 1/8 | 1/8 | .95 | .26 | .59 | .57 |
| 372PLPSP-4 | 1/4 | 1/4 | .98 | .43 | .77 | .73 |
| 372PLPSP-6 | 3/8 | 3/8 | 1.61 | .35 | .96 | .98 |
| 372PLPSP-8 | 1/2 | 1/2 | 2.01 | .51 | 1.12 | 1.38 |

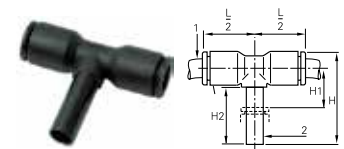

372PLPSP Plug-In Branch Tee

| PART NO. | 1 TUBE SIZE MM | 2 TUBE SIZE MM | H | H1 | H2 | L/2 |
|------------------|----------------|----------------|------|------|------|------|
| 372PLPSP-4M | 4 | 4 | 23.0 | 6.0 | 15.5 | 14.5 |
| 372PLPSP-6M | 6 | 6 | 26.5 | 7.0 | 17.0 | 16.0 |
| 372PLPSP-8M | 8 | 8 | 33.5 | 8.0 | 21.5 | 23.0 |
| 372PLPSP-10M | 10 | 10 | 39.0 | 9.5 | 24.5 | 26.5 |
| 372PLPSP-12M | 12 | 12 | 44.5 | 10.0 | 27.5 | 31.0 |
| 372PLPSP-4M-6M | 4 | 6 | 26.5 | 7.0 | 17.0 | 16.0 |
| 372PLPSP-6M-8M | 6 | 8 | 33.5 | 8.0 | 21.5 | 23.0 |
| 372PLPSP-8M-10M | 8 | 10 | 39.0 | 9.5 | 24.5 | 26.5 |
| 372PLPSP-10M-12M | 10 | 12 | 44.5 | 10.0 | 27.5 | 31.0 |

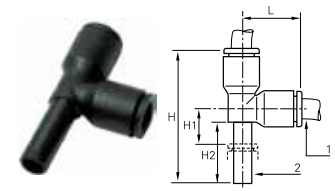

371PLPSP Plug-In Run Tee

| PART NO. | 1 TUBE SIZE IN | 2 TUBE SIZE IN | H | H1 | H2 | L |
|------------|----------------|----------------|------|-----|------|------|
| 371PLPSP-4 | 1/4 | 1/4 | 1.69 | .43 | .83 | .73 |
| 371PLPSP-6 | 3/8 | 3/8 | 2.23 | .33 | .96 | 1.00 |
| 371PLPSP-8 | 1/2 | 1/2 | 2.86 | .51 | 1.12 | 1.38 |

WARNING These products can expose you to chemicals including NICKEL, which is known to the state of California to cause cancer. For more information go to www.P65Warnings.ca.gov.



Click here for CADs, Product Specifications or to Configure Parts Online

A

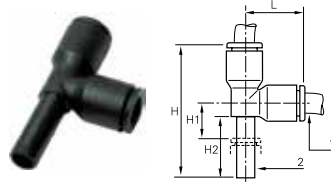

371PLPSP Plug-In Run Tee

| PART NO. | 1 TUBE SIZE MM | 2 TUBE SIZE MM | H | H1 | H2 | L |
|------------------|----------------|----------------|------|------|------|------|
| 371PLPSP-4M | 4 | 4 | 33.0 | 6.0 | 15.5 | 14.5 |
| 371PLPSP-6M | 6 | 6 | 38.5 | 7.0 | 17.0 | 17.5 |
| 371PLPSP-8M | 8 | 8 | 49.0 | 8.0 | 21.5 | 23.0 |
| 371PLPSP-10M | 10 | 10 | 57.0 | 10.5 | 24.5 | 26.5 |
| 371PLPSP-12M | 12 | 12 | 65.5 | 10.5 | 27.5 | 31.0 |
| 371PLPSP-4M-6M | 4 | 6 | 10.5 | 7.0 | 17.0 | 17.5 |
| 371PLPSP-6M-8M | 6 | 8 | 13.5 | 8.0 | 21.5 | 23.0 |
| 371PLPSP-8M-10M | 8 | 10 | 16.0 | 10.5 | 24.5 | 26.5 |
| 371PLPSP-10M-12M | 10 | 12 | 19.0 | 10.5 | 27.5 | 31.0 |

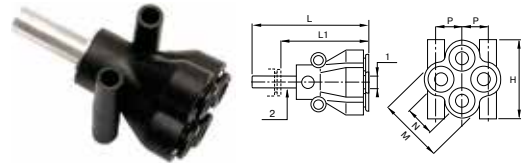

362PLPDSP Plug-In Multiple Y

| PART NO. | 1 TUBE SIZE MM | 2 TUBE SIZE MM | H | L | L1 | M | N |
|-----------------|----------------|----------------|------|------|------|------|------|
| 362PLPDSP-4M-6M | 4 | 6 | 25.5 | 45.0 | 31.0 | 21.0 | 10.0 |
| 362PLPDSP-4M-8M | 4 | 8 | 25.5 | 49.5 | 31.0 | 21.0 | 10.0 |
| 362PLPDSP-6M-8M | 6 | 8 | 31.5 | 59.5 | 41.0 | 26.5 | 12.0 |

*Aluminum tail piece

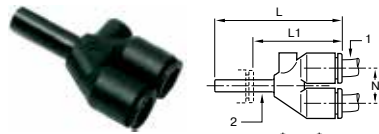
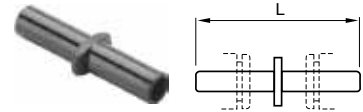

362PLPSP Plug-In Y

| PART NO. | 1 TUBE SIZE IN | 2 TUBE SIZE IN | L | L1 | N |
|------------|----------------|----------------|------|------|-----|
| 362PLPSP-2 | 1/8 | 1/8 | 1.36 | 1.00 | .35 |
| 362PLPSP-4 | 1/4 | 1/4 | 1.60 | 1.02 | .45 |
| 362PLPSP-6 | 3/8 | 3/8 | 2.23 | 1.42 | .67 |

63PLP Double Male Union

| PART NO. | TUBE SIZE IN | L |
|----------|--------------|------|
| 63PLP-4 | 1/4 | 1.52 |
| 63PLP-6 | 3/8 | 2.03 |

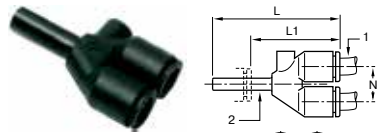
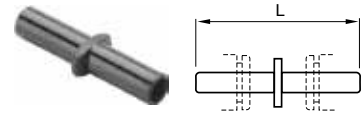

362PLPSP Plug-In Y

| PART NO. | 1 TUBE SIZE MM | 2 TUBE SIZE MM | L | L1 | N |
|------------------|----------------|----------------|------|------|------|
| 362PLPSP-4M | 4 | 4 | 34.0 | 21.5 | 9.0 |
| 362PLPSP-6M | 6 | 6 | 39.5 | 25.5 | 11.0 |
| 362PLPSP-8M | 8 | 8 | 50.5 | 32.0 | 14.5 |
| 362PLPSP-10M | 10 | 10 | 57.5 | 36.0 | 17.0 |
| 362PLPSP-12M | 12 | 12 | 66.0 | 41.0 | 20.0 |
| 362PLPSP-4M-6M | 4 | 6 | 35.5 | 21.5 | 9.0 |
| 362PLPSP-6M-8M | 6 | 8 | 44.0 | 25.5 | 11.0 |
| 362PLPSP-8M-10M | 8 | 10 | 53.5 | 32.0 | 14.5 |
| 362PLPSP-10M-12M | 10 | 12 | 60.0 | 35.0 | 17.0 |

63PLP Double Male Union

| PART NO. | TUBE SIZE MM | L |
|-----------|--------------|--------|
| 63PLP-4M | 4 | 34 1/2 |
| 63PLP-6M | 6 | 38 1/2 |
| 63PLP-8M | 8 | 41 |
| 63PLP-10M | 10 | 51 1/2 |
| 63PLP-12M | 12 | 60 |
| 63PLP-14M | 14 | 69 1/2 |

WARNING These products can expose you to chemicals including NICKEL, which is known to the state of California to cause cancer. For more information go to www.P65Warnings.ca.gov.



Click here for CADs, Product Specifications or to Configure Parts Online



37PLP Tube Reducer

| PART NO. | 1 TUBE SIZE IN | 2 TUBE SIZE IN | L | L1 |
|------------|----------------|----------------|------|------|
| 37PLP-2-4M | 1/8 | 5/32 (4M) | 1.79 | 1.32 |
| 37PLP-2-3 | 1/8 | 3/16 | 1.79 | 1.14 |
| 37PLP-2-4 | 1/8 | 1/4 | 1.79 | 1.22 |
| 37PLP-4M-3 | 5/32 (4MM) | 3/16 | 1.48 | .83 |
| 37PLP-4M-4 | 5/32 (4MM) | 1/4 | 1.48 | .91 |
| 37PLP-4M-6 | 5/32 (4MM) | 3/8 | 1.61 | .81 |
| 37PLP-3-8M | 3/16 | 5/16 (8M) | 1.79 | 1.06 |
| 37PLP-3-4 | 3/16 | 1/4 | 1.79 | 1.22 |
| 37PLP-4-8M | 1/4 | 5/16 (8M) | 1.61 | .89 |
| 37PLP-4-6 | 1/4 | 3/8 | 1.61 | .81 |
| 37PLP-4-8 | 1/4 | 1/2 | 1.97 | .98 |
| 37PLP-8M-6 | 5/16 (8MM) | 3/8 | 1.93 | 1.12 |
| 37PLP-8M-8 | 5/16 (8MM) | 1/2 | 2.01 | 1.02 |
| 37PLP-6-8 | 3/8 | 1/2 | 2.01 | 1.04 |

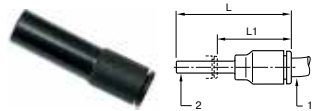

37PLP Tube Reducer

| PART NO. | 1 TUBE SIZE MM | 2 TUBE SIZE MM | L | L1 |
|---------------|----------------|----------------|------|------|
| 37PLP-4M-6M | 4 | 6 | 37.5 | 23.5 |
| 37PLP-4M-8M | 4 | 8 | 37.5 | 19.0 |
| 37PLP-6M-8M | 6 | 8 | 36.0 | 20.5 |
| 37PLP-4M-10M | 4 | 10 | 44.0 | 22.5 |
| 37PLP-6M-10M | 6 | 10 | 38.0 | 17.5 |
| 37PLP-8M-10M | 8 | 10 | 49.0 | 28.5 |
| 37PLP-10M-12M | 10 | 12 | 56.5 | 33.5 |
| 37PLP-6M-12M | 6 | 12 | 46.0 | 23.0 |
| 37PLP-8M-12M | 8 | 12 | 49.0 | 24.5 |
| 37PLP-10M-14M | 10 | 14 | 58.5 | 33.5 |
| 37PLP-12M-14M | 12 | 14 | 58.5 | 33.5 |
| 37PLP-6M-14M | 6 | 14 | 48.0 | 23.0 |
| 37PLP-8M-14M | 8 | 14 | 48.0 | 23.0 |

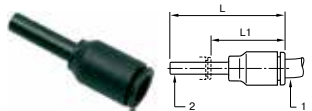

32PLPSP Tube Expander

| PART NO. | 1 TUBE SIZE IN | 2 TUBE SIZE IN | L | L1 |
|--------------|----------------|----------------|------|------|
| 32PLPSP-4-2 | 1/4 | 1/8 | 1.61 | 1.16 |
| 32PLPSP-4-6M | 1/4 | 6M | 1.75 | 1.02 |
| 32PLPSP-4-4M | 1/4 | 5/32 (4M) | 1.61 | 1.14 |
| 32PLPSP-4-3 | 1/4 | 3/16 | 1.61 | 1.00 |
| 32PLPSP-6-4 | 3/8 | 1/4 | 1.58 | 1.00 |

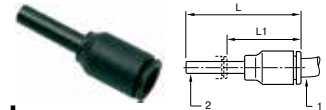

32PLPSP Tube Expander

| PART NO. | 1 TUBE SIZE MM | 2 TUBE SIZE MM | L | L1 |
|-----------------|----------------|----------------|------|------|
| 32PLPSP-6M-4M | 6 | 4 | 35.0 | 23.0 |
| 32PLPSP-8M-6M | 8 | 6 | 45.0 | 31.5 |
| 32PLPSP-10M-8M | 10 | 8 | 42.5 | 21.0 |
| 32PLPSP-12M-10M | 12 | 10 | 49.0 | 24.5 |



32PLPSP Tube Converter

| PART NO. | 1 TUBE SIZE MM | 2 TUBE SIZE IN | L | L1 |
|--------------|----------------|----------------|------|------|
| 32PLPSP-4M-2 | 4M | 1/8 | 1.61 | 1.16 |
| 32PLPSP-8M-4 | 8M | 1/4 | 1.58 | 1.00 |

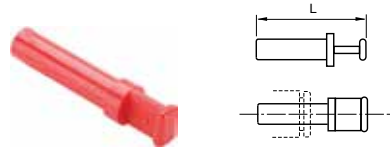

639PLP Plug Inch

| PART NO. | TUBE SIZE | L |
|----------|-----------|------|
| 639PLP-2 | 1/8 | 1.30 |
| 639PLP-3 | 3/16 | 1.36 |
| 639PLP-4 | 1/4 | 1.44 |
| 639PLP-6 | 3/8 | 1.67 |
| 639PLP-8 | 1/2 | 1.91 |

639PLP Plug Metric

| PART NO. | TUBE SIZE | L |
|-------------|-----------|----|
| 639PLP-3M | 3 | 25 |
| 639PLP-4M | 4 | 30 |
| 639PLP-6M | 6 | 33 |
| 639PLP-8M | 8 | 33 |
| 639PLP-10M | 10 | 42 |
| 639PLP-12M | 12 | 45 |
| 639PLP-14M | 14 | 49 |
| 639PLP-16M* | 16 | 57 |

* Nickel Plated Brass

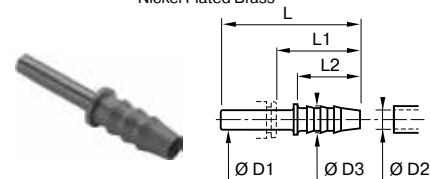

322PLPSP Barbed Connector

| PART NO. | OD 1 | OD 2 | OD 3 | L | L1 | L2 |
|----------------|-----------|------|------|------|------|-----|
| 322PLPSP-4M-2 | 5/32(4MM) | .120 | .20 | 1.46 | .98 | .67 |
| 322PLPSP-4M-5M | 5/32(4MM) | .200 | .28 | 1.46 | .98 | .67 |
| 322PLPSP-4-3* | 1/4 | 3/16 | | 1.65 | 1.00 | |
| 322PLPSP-8M-4 | 5/16(8MM) | .250 | .34 | 1.55 | .83 | .67 |
| 322PLPSP-8M-8M | 5/16(8MM) | .320 | .39 | 1.75 | 1.02 | .87 |
| 322PLPSP-6-8M | 3/8 | .320 | .39 | 1.97 | 1.16 | .87 |
| 322PLPSP-8-6* | 1/2 | .375 | .57 | 2.28 | 1.34 | .87 |

*Nickel-plated brass. Dimensions for OD2 are I.D. of the tube.

WARNING These products can expose you to chemicals including NICKEL, which is known to the state of California to cause cancer. For more information go to www.P65Warnings.ca.gov.



[Click here for CADs, Product Specifications or to Configure Parts Online](#)

A

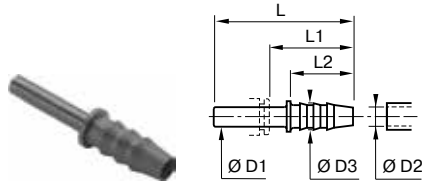

322PLPSP Barbed Connector

| PART NO. | OD 1 | OD 2 | OD 3 | L | L1 | L2 |
|------------------|------|------|------|------|------|------|
| 322PLPSP-4M-3M | 4 | 3.2 | 5.0 | 37.0 | 25.0 | 17.0 |
| 322PLPSP-4M-5M | 4 | 5.0 | 7.0 | 37.0 | 25.0 | 17.0 |
| 322PLPSP-6M-5M | 6 | 5.0 | 7.0 | 39.0 | 25.0 | 17.0 |
| 322PLPSP-8M-6M | 8 | 6.3 | 8.5 | 39.5 | 21.0 | 17.0 |
| 322PLPSP-8M-8M | 8 | 8.0 | 10.0 | 44.5 | 26.0 | 22.0 |
| 322PLPSP-10M-6M | 10 | 6.3 | 8.0 | 45.0 | 24.5 | 17.0 |
| 322PLPSP-10M-8M | 10 | 8.0 | 10.0 | 50.0 | 29.5 | 22.0 |
| 322PLPSP-12M-8M | 12 | 8.0 | 10.0 | 50.0 | 26.0 | 22.0 |
| 322PLPSP-12M-10M | 12 | 10.0 | 12.0 | 48.5 | 25.5 | 22.5 |
| 322PLPSP-12M-12M | 12 | 12.5 | 14.5 | 57.0 | 34.0 | 22.5 |
| 322PLPSP-14M-12M | 14 | 12.5 | 14.5 | 59.5 | 34.5 | 22.5 |

*Nickel-plated brass. Dimensions for OD2 are I.D. of the tube.

B

C

D

E

F

G

H

I

J

K

L

M

N

O

32PLPDRC Connector for 3 Tubes

| PART NO. | TUBE SIZE MM | H | K | L | N |
|-------------|--------------|------|------|------|---|
| 32PLPDRC-4M | 4 | 36.5 | 11.0 | 39.5 | |
| 32PLPDRC-6M | 6 | 36.5 | 11.0 | 39.5 | |
| 32PLPDRC-8M | 8 | 46.0 | 13.0 | 14.5 | |

Clip Strips for Tubing and Fittings

| PART NO. | D TUBE | LF3000 TO BE CLIPPED | H MM | K MM | N MM | NO. PER STRIP |
|------------|----------------|----------------------|------|------|------|---------------|
| CLIP 04 00 | 5/32, 4MM | - | 9 | 13.5 | 10.5 | 8 |
| CLIP 06 00 | 1/4, 3/16, 6MM | - | 10.5 | 13 | 10.5 | 8 |
| CLIP 08 00 | 5/16, 8MM | 5/32, 4MM | 12.5 | 10.5 | 12 | 7 |
| CLIP 10 00 | 3/8, 10MM | 1/4, 6MM | 14 | 12 | 15 | 6 |
| CLIP 12 00 | 1/2, 12MM | | 16.5 | 14 | 16.5 | 5 |
| CLIP 14 00 | 14MM | 5/16, 8MM | 18 | 16 | 20.5 | 4 |

Clip strips come complete with screws of .375 inches in length.

32PLPRC Connector for 2 Tubes

| PART NO. | TUBE SIZE IN | H | K | L |
|-----------|--------------|------|-----|------|
| 32PLPRC-4 | 1/4 | 1.44 | .47 | 1.18 |

32PLPRC Connector for 2 Tubes

| PART NO. | TUBE SIZE MM | H | K | L |
|------------|--------------|------|------|------|
| 32PLPRC-4M | 4 | 36.5 | 11.0 | 39.5 |
| 32PLPRC-6M | 6 | 36.5 | 11.0 | 39.5 |
| 32PLPRC-8M | 8 | 46.0 | 13.0 | 44.5 |

3151 End Caps

| PART NO. | D IN | G MM | H MM |
|------------|------|------|------|
| 3151 53 00 | 1/8 | .33 | .55 |
| 3151 04 00 | 5/32 | .33 | .55 |
| 3151 56 00 | 1/4 | .41 | .64 |
| 3151 08 00 | 5/16 | .53 | .86 |
| 3151 60 00 | 3/8 | .53 | .86 |

3151 End Caps

| PART NO. | D MM | G MM | H MM |
|------------|------|------|------|
| 3151 04 00 | 4 | 8.5 | 14.7 |
| 3151 06 00 | 6 | 10.5 | 16.9 |
| 3151 08 00 | 8 | 13.5 | 21.9 |
| 3151 10 00 | 10 | 16 | 22.2 |
| 3151 12 00 | 12 | 19 | 27.7 |

WARNING These products can expose you to chemicals including NICKEL, which is known to the state of California to cause cancer. For more information go to www.P65Warnings.ca.gov.



[Click here for CADs, Product Specifications or to Configure Parts Online](#)

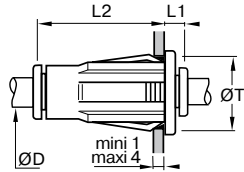

Minimum distance between fittings.
Diameter of fixing hole.

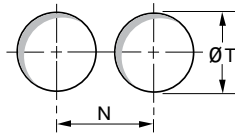

32PLPBHP Plug-in Bulkhead Union

| PART NO. | TUBE SIZE IN | L1 | L2 | ØT |
|-------------|--------------|-----|-------|------|
| 32PLPBHP-4 | 1/4 | .26 | 1.240 | .75 |
| 32PLPBHP-8M | 5/16 (8MM) | .30 | 1.280 | .87 |
| 32PLPBHP-6 | 3/8 | .30 | 1.630 | 1.12 |

Fixing Hole

| D | 5/32 | 1/4 | 5/16 | 3/8 | 1/2 |
|----------|-------|-------|-------|--------|--------|
| T inches | 5/8" | 3/4" | 7/8" | 1 1/8" | 1 1/4" |
| T mm | 15.87 | 19.05 | 22.22 | 28.57 | 31.75 |
| N in | .89 | 1.00 | 1.08 | 1.34 | 1.50 |

Tolerance T: +0.3 -0.1

Installation

1. Mark out the fixing hole
2. Make hole in panel
3. Simply push the fitting into place
4. To complete the installation
5. To identify circuits simply remove the black release button and replace with colored one

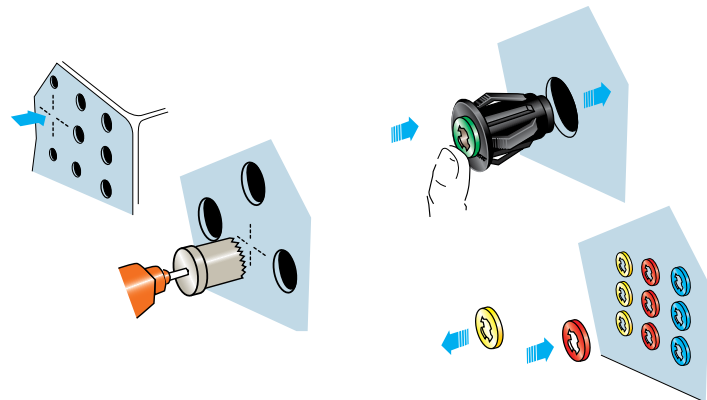

AQRT - Quick Release Tool

Makes disconnection of tube adapters and tubing a breeze.



3110 - 3330 Caps Manual Release Button - Inch

| TUBE O.D. | WHITE PART NO. | BLACK PART NO. | GREEN PART NO. | RED PART NO. | BLUE PART NO. | YELLOW PART NO. |
|-----------|----------------|----------------|----------------|--------------|---------------|-----------------|
| 1/8 | 3110 53 00 | - | 3110 53 02 | 3110 53 03 | 3110 53 04 | 3110 53 05 |
| 5/32 | 3110 04 00 | 3330 04 01 | 3110 04 02 | 3110 04 03 | 3110 04 04 | 3110 04 05 |
| 3/16 | 3330 55 00 | 3330 55 01 | 3330 55 02 | 3330 55 03 | 3330 55 04 | 3330 55 05 |
| 1/4 | 3110 56 00 | 3330 56 01 | 3110 56 02 | 3110 56 03 | 3110 56 04 | 3110 56 05 |
| 5/16 | 3110 08 00 | - | 3110 08 02 | 3110 08 03 | 3110 08 04 | 3110 08 05 |
| 3/8 | 3110 60 00 | - | - | - | 3110 60 04 | 3110 60 05 |
| 1/2 | 3110 62 00 | 3330 62 01 | 3110 62 02 | 3110 62 03 | 3110 62 04 | 3110 62 05 |



3110 - 3330 Caps Manual Release Button - Metric

| TUBE MM | WHITE PART NO. | BLACK PART NO. | GREEN PART NO. | RED PART NO. | BLUE PART NO. | YELLOW PART NO. |
|---------|----------------|----------------|----------------|--------------|---------------|-----------------|
| 4 | 3110 04 00 | 3330 04 01 | 3110 04 02 | 3110 04 03 | 3110 04 04 | 3110 04 05 |
| 6 | 3110 06 00 | 3330 06 01 | 3110 06 02 | 3110 06 03 | 3110 06 04 | 3110 06 05 |
| 8 | 3110 08 00 | - | 3110 08 02 | 3110 08 03 | 3110 08 04 | 3110 08 05 |
| 10 | 3110 10 00 | - | 3110 10 02 | 3110 10 03 | 3110 10 04 | 3110 10 05 |
| 12 | 3110 12 00 | - | 3110 12 02 | 3110 12 03 | 3110 12 04 | 3110 12 05 |
| 14 | 3110 14 00 | - | 3110 14 02 | 3110 14 03 | 3110 14 04 | 3110 14 05 |

In all sizes of the LF3000 fittings, except 3/16, the push button is an integral part of the design which makes it non-removable, and comes standard in black. For identification of the circuits, colored caps (p/n 3110) fit over the black push button.

On the 3/16 sizes, the buttons are removable and can be replaced with a button of another color (p/n 3330).

Six colors are available which allow color coding of the fitting, in association with tubes of the same color.

WARNING These products can expose you to chemicals including NICKEL, which is known to the state of California to cause cancer. For more information go to www.P65Warnings.ca.gov.



A

B

C

D

E

F

G

H

I

J

K

L

M

N

O



Oscillating Elbows

Parker's oscillating fittings are designed to satisfy the requirements of industrial automation and robotics. The oscillating fitting features low-friction washers enabling the fitting to rotate in conjunction with the stroke of the cylinder piston.

Product Features:

- Glass reinforced nylon 6.6 body
- Nylon collar
- Stainless Steel gripping ring
- Nitrile D seal
- Nitrile o-ring
- Nickel-plated brass threads

Markets:

- Robotics
- Pneumatics
- Textile
- Packaging
- Semi-conductors

Applications:

- Air
- Cutting Fluids
- Inert Gases

Specifications:

Pressure Range Up to 290 PSI (19.9 bar)
depending on tubing

Temperature Range -4° to +175° F (-20° to +79.4° C)

Compatible Tubing:

- Semi-rigid nylon
- Polyurethane 95 Durometer Shore A
- Nylon
- Fluoropolymer

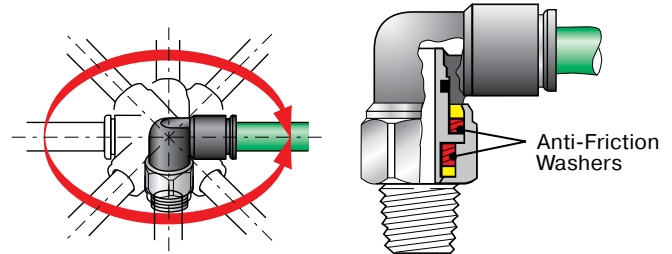

| O.D. TUBE INCH & MM | 5/32 & 4 | 1/4 & 6 | 8 | 10 | 12 |
|---|----------|---------|-----|----|----|
| "MAXIMUM ROTATION SPEED IN RADIAN/SECOND" | 190 | 160 | 120 | 90 | 80 |

Assembly Instructions

1. Cut tubing squarely – maximum of 15° angle allowable.
2. Check that port or mating part is clean and free of debris.
3. Mark tubing to appropriate tube insertion length. (see Tube Insertion Chart on page N22)
4. Insert tubing until it bottoms
5. Pull on tubing to verify it is fully inserted
6. To disassemble, simply press release button, hold against body and pull tubing out of fitting.

WARNING These products can expose you to chemicals including LEAD which is known to the state of California to cause cancer and birth defects or other reproductive harm. For more information go to www.P65Warnings.ca.gov.



[Click here for CADs, Product Specifications or to Configure Parts Online](#)

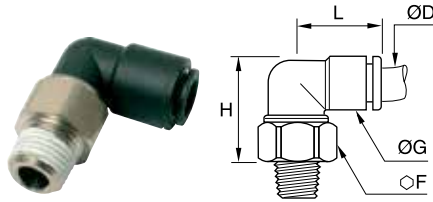

W369PLPO Oscillating Compact Elbow - NPT

| PART NO. | TUBE SIZE IN | NPT | F | G | H | L |
|---------------|--------------|-----|----|-----|------|-----|
| W369PLPO-4M-2 | 5/32(4MM) | 1/8 | 12 | .43 | .85 | .69 |
| W369PLPO-4-2 | 1/4 | 1/8 | 14 | .55 | 1.04 | .81 |
| W369PLPO-4-4 | 1/4 | 1/4 | 14 | .55 | 1.04 | .81 |

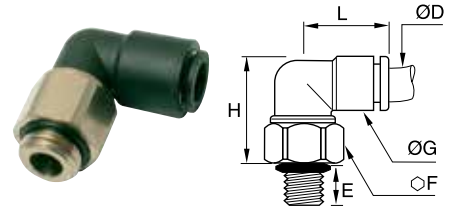

369PLPO Oscillating Compact Elbow - BSPP, M5

| PART NO. | TUBE SIZE MM | M5/BSPP | E | F | G | H | L |
|----------------|--------------|---------|-----|----|------|------|------|
| 369PLPO-4M-M5 | 4 | M5X0.8 | 3.0 | 12 | 11.0 | 24.5 | 17.5 |
| 369PLPO-4M-2G | 4 | 1/8 | 5.0 | 13 | 11.0 | 23.0 | 17.5 |
| 369PLPO-6M-M5 | 6 | M5X0.8 | 3.0 | 12 | 14.0 | 27.5 | 20.5 |
| 369PLPO-6M-2G | 6 | 1/8 | 5.0 | 14 | 14.0 | 27.0 | 20.5 |
| 369PLPO-6M-4G | 6 | 1/4 | 5.5 | 16 | 14.0 | 25.5 | 20.5 |
| 369PLPO-8M-2G | 8 | 1/8 | 5.0 | 17 | 16.0 | 33.5 | 23.5 |
| 369PLPO-8M-4G | 8 | 1/4 | 5.5 | 17 | 16.0 | 31.0 | 23.5 |
| 369PLPO-8M-6G | 8 | 3/8 | 5.5 | 20 | 16.0 | 29.5 | 23.5 |
| 369PLPO-10M-4G | 10 | 1/4 | 5.5 | 19 | 19.5 | 50.0 | 29.0 |
| 369PLPO-10M-6G | 10 | 3/8 | 5.5 | 20 | 19.5 | 37.0 | 29.0 |
| 369PLPO-12M-4G | 12 | 1/4 | 5.5 | 21 | 22.0 | 46.5 | 33.5 |
| 369PLPO-12M-6G | 12 | 3/8 | 5.5 | 21 | 22.0 | 45.5 | 33.5 |

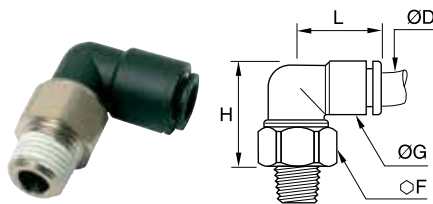

W369PLPO Oscillating Compact Elbow - BSPT

| PART NO. | TUBE SIZE MM | BSPT | F | G | H | L |
|-----------------|--------------|------|----|------|------|------|
| W369PLPO-4M-2R | 4 | 1/8 | 12 | 11.0 | 22.0 | 17.5 |
| W369PLPO-6M-2R | 6 | 1/8 | 14 | 14.0 | 26.5 | 20.5 |
| W369PLPO-6M-4R | 6 | 1/4 | 14 | 14.0 | 23.5 | 20.5 |
| W369PLPO-8M-2R | 8 | 1/8 | 17 | 16.0 | 32.0 | 23.5 |
| W369PLPO-8M-4R | 8 | 1/4 | 17 | 16.0 | 29.0 | 23.5 |
| W369PLPO-8M-6R | 8 | 3/8 | 17 | 16.0 | 25.0 | 23.5 |
| W369PLPO-10M-4R | 10 | 1/4 | 19 | 19.5 | 37.5 | 29.0 |
| W369PLPO-10M-6R | 10 | 3/8 | 19 | 19.5 | 33.5 | 29.0 |
| W369PLPO-12M-4R | 12 | 1/4 | 21 | 22.0 | 44.5 | 33.5 |
| W369PLPO-12M-6R | 12 | 3/8 | 21 | 22.0 | 41.0 | 33.5 |

WARNING These products can expose you to chemicals including LEAD which is known to the state of California to cause cancer and birth defects or other reproductive harm. For more information go to www.P65Warnings.ca.gov.



- A
- B
- C
- D
- E
- F
- G
- H
- I
- J
- K
- L
- M
- N
- O

A

B

C

D

E

F

G

H

I

J

K

L

M

N

O



Prestolok PLM Metal Push-to-Connect Fittings

To meet your technical and environment requirements, Parker's Prestolok PLM fittings offers the robustness, reliability and resistance to industrial fluids for the most demanding environments.

Product Features:

- High phosphorous, FDA-compliant, chemical resistant, nickel-plated collet and body
- FKM seal
- Chemical, corrosion, and abrasion resistance
- NPT, BSPT, BSPP, and metric threads
- Silicone Free

Markets:

- Industrial
- Chemical
- Life Science
- Automation
- Food Processing

Compatible Media:

- Food Fluids
- Harsh Detergents
- Cleaning In Cold/Hot Water
- Steam
- Oils
- Compressed Air
- Inert Gases

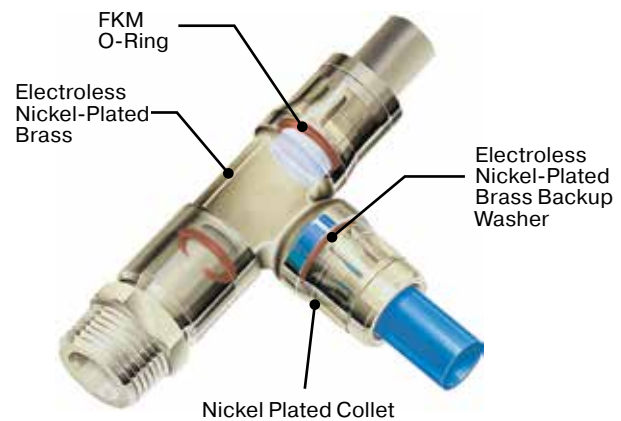

Specifications:

Pressure Range Up to 435 psi (30 bar)
290 psi (19.9 bar) for 169PLM

Temperature Range -13° to +302° F (-25° to +150° C)

Vacuum Rating 28" Hg

Note: Maximum pressure and temperature range depend on the type of tubing used.

Compatible Tubing:

- Polyethylene
- Polyurethane 95 Durometer Shore A
- FEP
- Nylon

Assembly Instructions

1. Cut tubing squarely maximum of 15° angle allowable.
2. Check that port or mating part is clean and free of debris.
3. Mark tubing to appropriate tube insertion length. (see Tube Insertion Chart on page N22)
4. Insert tubing until it bottoms
5. Pull on tubing to verify it is fully inserted
6. To disassemble, simply press release button, hold against body and pull tubing out of fitting.

WARNING These products can expose you to chemicals including LEAD which is known to the state of California to cause cancer and birth defects or other reproductive harm. For more information go to www.P65Warnings.ca.gov.



■ Threaded Fittings

68PLM

Male Connector
NPT, BSPT
p. A46



68PLM

Male Connector
BSPP
p. A46



66PLM

Female Connector
BSPP
p. A46



68PLMSP

Male Standpipe
to BSPT
p. A47



68PLMSP

Male Standpipe
to BSPP
p. A47



169PLM

Male Elbow
NPT, BSPT
p. A47



169PLM

Male Elbow
BSPP
p. A48



169PLMX

Extended Male
Elbow – BSPT
p. A48



169PLMX

Extended Male
Elbow – BSPP
p. A48



171PLM

Male Run Tee
NPT, BSPT
p. A48, A49



171PLM

Male Run Tee
BSPP
p. A49



172PLM

Male Branch Tee
NPT, BSPT
p. A49



172PLM

Male Branch Tee
BSPP
p. A50



■ Tube to Tube Fittings

62PLM

Union
p. A50



165PLM

Union Elbow
p. A51



164PLM

Union Tee
p. A51



■ Bulkhead Unions

62PLMBH

Bulkhead Union
p. A50



66PLMBH

Female Bulkhead
p. A50



165PLMBH

Bulkhead Union
p. A51



■ Modular Fittings

169PLMBJ

Single Banjo
p. A52



■ Plug-In Fittings & Accessories

67PLM

Tube Reducer
p. A51



639PLM

Plug
p. A52



PLMC

Cartridge
p. A52



62PLMSP

Tube Expander
p. A52



62PLMSP

Tube Converter
p. A52



122PLMSP

Barbed Connector
p. A52



63PLM

Double Male Union
p. A52



WARNING These products can expose you to chemicals including LEAD which is known to the state of California to cause cancer and birth defects or other reproductive harm. For more information go to www.P65Warnings.ca.gov.



[Click here for CADs, Product Specifications or to Configure Parts Online](#)

- A
- B
- C
- D
- E
- F
- G
- H
- I
- J
- K
- L
- M
- N
- O

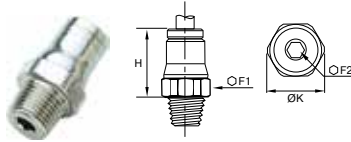

68PLM Male Connector Inch Tube to NPT/UNF

| PART NO. | TUBE SIZE IN | NPT/UNF | F1 MM | F2 MM | H IN | K IN |
|------------|--------------|---------|-------|-------|------|------|
| 68PLM-4M-0 | 5/32(4MM) | 10-32 | 10 | 2.5 | .61 | .43 |
| 68PLM-4M-2 | 5/32(4MM) | 1/8 | 11 | 3.0 | .59 | .47 |
| 68PLM-4M-4 | 5/32(4MM) | 1/4 | 14 | 3.0 | .59 | .59 |
| 68PLM-4-0 | 1/4 | 10-32 | 13 | 2.5 | .75 | .55 |
| 68PLM-4-2 | 1/4 | 1/8 | 13 | 4.0 | .67 | .55 |
| 68PLM-4-4 | 1/4 | 1/4 | 14 | 4.0 | .67 | .59 |
| 68PLM-4-6 | 1/4 | 3/8 | 18 | 5.0 | .67 | .77 |
| 68PLM-6-2 | 3/8 | 1/8 | 18 | 4.0 | .97 | .77 |
| 68PLM-6-4 | 3/8 | 1/4 | 18 | 7.0 | .95 | .77 |
| 68PLM-6-6 | 3/8 | 3/8 | 18 | 8.0 | .91 | .77 |
| 68PLM-6-8 | 3/8 | 1/2 | 22 | 8.0 | .95 | .94 |
| 68PLM-8-6 | 1/2 | 3/8 | 22 | 9.0 | .95 | .94 |
| 68PLM-8-8 | 1/2 | 1/2 | 22 | 10.0 | .95 | .94 |

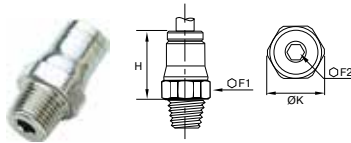

68PLM Male Connector Metric Tube to BSPT

| PART NO. | TUBE SIZE MM | BSPT | F1 MM | F2 MM | H MM | K MM |
|--------------|--------------|------|-------|-------|-------|-------|
| 68PLM-4M-2R | 4 | 1/8 | 10 | 3 | 15.00 | 11.00 |
| 68PLM-4M-4R | 4 | 1/4 | 14 | 3 | 15.00 | 15.00 |
| 68PLM-6M-2R | 6 | 1/8 | 13 | 4 | 17.00 | 14.00 |
| 68PLM-6M-4R | 6 | 1/4 | 14 | 4 | 17.00 | 15.00 |
| 68PLM-8M-2R | 8 | 1/8 | 15 | 5 | 19.00 | 16.00 |
| 68PLM-8M-4R | 8 | 1/4 | 15 | 6 | 18.00 | 16.00 |
| 68PLM-8M-6R | 8 | 3/8 | 17 | 6 | 18.50 | 18.50 |
| 68PLM-10M-4R | 10 | 1/4 | 18 | 7 | 23.00 | 19.50 |
| 68PLM-10M-6R | 10 | 3/8 | 18 | 8 | 22.50 | 19.50 |
| 68PLM-10M-8R | 10 | 1/2 | 22 | 8 | 22.50 | 24.00 |
| 68PLM-12M-4R | 12 | 1/4 | 20 | 7 | 25.50 | 22.00 |
| 68PLM-12M-6R | 12 | 3/8 | 20 | 9 | 24.00 | 22.00 |
| 68PLM-12M-8R | 12 | 1/2 | 22 | 10 | 23.00 | 24.00 |
| 68PLM-14M-6R | 14 | 3/8 | 22 | 9 | 27.00 | 24.00 |
| 68PLM-14M-8R | 14 | 1/2 | 24 | 11 | 26.00 | 26.00 |

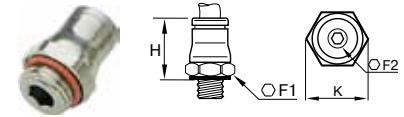

68PLM Male Connector Tube to UNF, BSPP or Metric

| PART NO. | TUBE SIZE MM | BSPP/METRIC | F1 MM | F2 MM | H MM | K MM |
|--------------|--------------|-------------|-------|-------|-------|-------|
| 68PLM-4M-M5 | 4 | M5X0.8 | 10 | 2.50 | 15.50 | 11.00 |
| 68PLM-4M-M6 | 4 | M6X1 | 13 | 3.00 | 14.50 | 14.00 |
| 68PLM-4M-2G | 4 | 1/8 | 10 | 3.00 | 16.00 | 11.00 |
| 68PLM-4M-4G | 4 | 1/4 | 16 | 3.00 | 14.50 | 17.50 |
| 68PLM-4M-M8 | 4 | M8X1 | 11 | 3.00 | 14.50 | 12.00 |
| 68PLM-6M-M5 | 6 | M5X0.8 | 13 | 2.50 | 19.00 | 14.00 |
| 68PLM-6M-2G | 6 | 1/8 | 13 | 4.00 | 17.50 | 14.00 |
| 68PLM-6M-M10 | 6 | M10X1 | 13 | 4.00 | 17.50 | 14.00 |
| 68PLM-6M-4G | 6 | 1/4 | 16 | 4.00 | 17.00 | 17.50 |
| 68PLM-8M-2G | 8 | 1/8 | 15 | 5.00 | 20.00 | 16.00 |
| 68PLM-8M-4G | 8 | 1/4 | 16 | 6.00 | 18.00 | 17.50 |
| 68PLM-8M-6G | 8 | 3/8 | 20 | 6.00 | 19.00 | 22.00 |
| 68PLM-10M-4G | 10 | 1/4 | 18 | 7.00 | 25.00 | 19.50 |
| 68PLM-10M-6G | 10 | 3/8 | 20 | 8.00 | 22.50 | 22.00 |
| 68PLM-10M-8G | 10 | 1/2 | 24 | 8.00 | 22.50 | 26.00 |
| 68PLM-12M-4G | 12 | 1/4 | 20 | 7.00 | 27.00 | 22.00 |
| 68PLM-12M-6G | 12 | 3/8 | 20 | 9.00 | 26.00 | 22.00 |
| 68PLM-12M-8G | 12 | 1/2 | 24 | 10.00 | 23.50 | 26.00 |
| 68PLM-14M-6G | 14 | 3/8 | 22 | 9.00 | 28.00 | 24.00 |
| 68PLM-14M-8G | 14 | 1/2 | 24 | 11.00 | 26.50 | 26.00 |

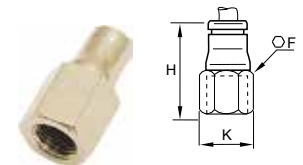

66PLM Female Connector Metric Tube to BSPP or M5

| PART NO. | TUBE SIZE MM | BSPP/M5 | F MM | H MM | K MM |
|--------------|--------------|---------|------|-------|-------|
| 66PLM-4M-M5 | 4 | M5X0.8 | 10 | 22.00 | 11.00 |
| 66PLM-4M-2G | 4 | 1/8 | 14 | 25.00 | 15.00 |
| 66PLM-4M-4G | 4 | 1/4 | 17 | 29.00 | 18.50 |
| 66PLM-6M-2G | 6 | 1/8 | 14 | 27.50 | 15.00 |
| 66PLM-6M-4G | 6 | 1/4 | 17 | 31.50 | 18.50 |
| 66PLM8M-2G | 8 | 1/8 | 15 | 28.50 | 16.00 |
| 66PLM-8M-4G | 8 | 1/4 | 17 | 32.50 | 18.50 |
| 66PLM-10M-6G | 10 | 3/8 | 22 | 38.00 | 24.00 |
| 66PLM-12M-6G | 12 | 3/8 | 22 | 39.00 | 24.00 |
| 66PLM-12M-8G | 12 | 1/2 | 24 | 43.50 | 26.00 |

WARNING These products can expose you to chemicals including LEAD which is known to the state of California to cause cancer and birth defects or other reproductive harm. For more information go to www.P65Warnings.ca.gov.

[Click here for CADs, Product Specifications or to Configure Parts Online](#)

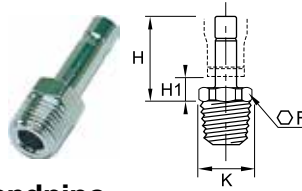

68PLMSP Male Stud Standpipe Metric Tube to BSPT

| PART NO. | TUBE SIZE MM | BSPT | F MM | H MM | H1 MM | K MM |
|----------------|--------------|------|------|-------|-------|-------|
| 68PLMSP-4M-2R | 4 | 1/8 | 10 | 21.00 | 7.00 | 11.00 |
| 68PLMSP-6M-2R | 6 | 1/8 | 10 | 23.50 | 6.50 | 11.00 |
| 68PLMSP-6M-4R | 6 | 1/4 | 10 | 23.50 | 6.50 | 15.00 |
| 68PLMSP-8M-2R | 8 | 1/8 | 10 | 24.00 | 6.50 | 11.00 |
| 68PLMSP-8M-4R | 8 | 1/4 | 14 | 24.00 | 6.50 | 15.00 |
| 68PLMSP-10M-4R | 10 | 1/4 | 14 | 22.00 | 6.50 | 15.00 |
| 68PLMSP-10M-6R | 10 | 3/8 | 17 | 30.00 | 7.50 | 18.50 |
| 68PLMSP-12M-6R | 12 | 3/8 | 17 | 31.00 | 7.50 | 18.50 |
| 68PLMSP-12M-8R | 12 | 1/2 | 22 | 38.00 | 7.50 | 24.00 |
| 68PLMSP-14M-8R | 14 | 1/2 | 22 | 33.00 | 8.00 | 24.00 |

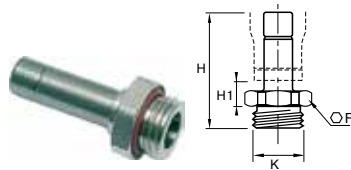

68PLMSP Male Standpipe Metric Tube to BSPP or M5

| PART NO. | TUBE SIZE MM | BSPP/M5 | F MM | H MM | H1 MM | K MM |
|----------------|--------------|---------|------|-------|-------|-------|
| 68PLMSP-4M-M5 | 4 | M5X0.8 | 13 | 25.50 | 7.00 | 14.00 |
| 68PLMSP-4M-2G | 4 | 1/8 | 16 | 26.50 | 7.00 | 17.50 |
| 68PLMSP-4M-4G | 4 | 1/4 | 8 | 25.00 | 7.50 | 8.70 |
| 68PLMSP-6M-2G | 6 | 1/8 | 13 | 28.00 | 6.50 | 14.00 |
| 68PLMSP-6M-4G | 6 | 1/4 | 16 | 29.00 | 6.50 | 17.50 |
| 68PLMSP-8M-2G | 8 | 1/8 | 13 | 28.50 | 6.50 | 14.00 |
| 68PLMSP-8M-4G | 8 | 1/4 | 16 | 29.50 | 6.50 | 17.50 |
| 68PLMSP-8M-6G | 8 | 3/8 | 20 | 30.50 | 7.50 | 22.00 |
| 68PLMSP-10M-4G | 10 | 1/4 | 16 | 34.50 | 6.50 | 17.50 |
| 68PLMSP-10M-6G | 10 | 3/8 | 20 | 35.50 | 7.50 | 22.00 |
| 68PLMSP-10M-8G | 10 | 1/2 | 24 | 37.00 | 7.50 | 26.00 |
| 68PLMSP-12M-6G | 12 | 3/8 | 20 | 36.50 | 7.50 | 22.00 |
| 68PLMSP-12M-8G | 12 | 1/2 | 24 | 38.00 | 7.50 | 26.00 |
| 68PLMSP-14M-8G | 14 | 1/2 | 24 | 40.00 | 8.00 | 26.00 |

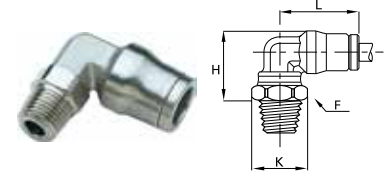

169PLM Male Elbow Inch Tube to NPT, UNF

| PART NO. | TUBE SIZE IN | NPT/UNF | F MM | H IN | K IN | L IN |
|-------------|--------------|---------|------|------|------|------|
| 169PLM-4M-0 | 5/32(4MM) | 10-32 | 10 | 0.71 | 0.43 | .71 |
| 169PLM-4M-2 | 5/32(4MM) | 1/8 | 11 | .59 | .47 | .71 |
| 169PLM-4M-4 | 5/32(4MM) | 1/4 | 14 | .67 | .60 | .71 |
| 169PLM-4-2 | 1/4 | 1/8 | 11 | .69 | .47 | .87 |
| 169PLM-4-4 | 1/4 | 1/4 | 14 | .75 | .60 | .87 |
| 169PLM-4-6 | 1/4 | 3/8 | 18 | .75 | .77 | .87 |
| 169PLM-6-4 | 3/8 | 1/4 | 15 | .93 | .63 | 1.14 |
| 169PLM-6-6 | 3/8 | 3/8 | 18 | 1.02 | .77 | 1.14 |
| 169PLM-6-8 | 3/8 | 1/2 | 22 | 1.06 | .94 | 1.14 |
| 169PLM-8-6 | 1/2 | 3/8 | 18 | 1.14 | .77 | 1.22 |
| 169PLM-8-8 | 1/2 | 1/2 | 22 | 1.14 | .94 | 1.22 |

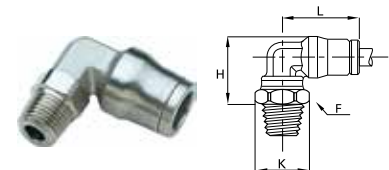

169PLM Male Elbow Metric Tube to BSPT

| PART NO. | TUBE SIZE MM | BSPT | F MM | H MM | K MM | L MM |
|---------------|--------------|------|------|-------|-------|-------|
| 169PLM-4M-2R | 4 | 1/8 | 11 | 15.00 | 12.00 | 18.00 |
| 169PLM-4M-4R | 4 | 1/4 | 14 | 17.00 | 15.00 | 18.00 |
| 169PLM-6M-2R | 6 | 1/8 | 11 | 17.50 | 12.00 | 21.50 |
| 169PLM-6M-4R | 6 | 1/4 | 14 | 19.00 | 15.00 | 21.50 |
| 169PLM-8M-2R | 8 | 1/8 | 11 | 19.50 | 12.00 | 23.50 |
| 169PLM-8M-4R | 8 | 1/4 | 14 | 21.00 | 15.00 | 23.50 |
| 169PLM-8M-6R | 8 | 3/8 | 17 | 21.00 | 18.50 | 23.50 |
| 169PLM-10M-4R | 10 | 1/4 | 15 | 23.50 | 16.00 | 29.00 |
| 169PLM-10M-6R | 10 | 3/8 | 17 | 25.50 | 18.50 | 29.00 |
| 169PLM-12M-4R | 12 | 1/4 | 15 | 26.00 | 16.00 | 31.00 |
| 169PLM-12M-6R | 12 | 3/8 | 17 | 28.50 | 18.50 | 31.00 |
| 169PLM-12M-8R | 12 | 1/2 | 21 | 28.50 | 23.00 | 31.00 |
| 169PLM-14M-6R | 14 | 3/8 | 19 | 29.00 | 21.00 | 34.00 |
| 169PLM-14M-8R | 14 | 1/2 | 24 | 30.00 | 26.00 | 34.00 |

WARNING These products can expose you to chemicals including LEAD which is known to the state of California to cause cancer and birth defects or other reproductive harm. For more information go to www.P65Warnings.ca.gov.



- A
- B
- C
- D
- E
- F
- G
- H
- I
- J
- K
- L
- M
- N
- O

[Click here for CADs, Product Specifications or to Configure Parts Online](#)

A

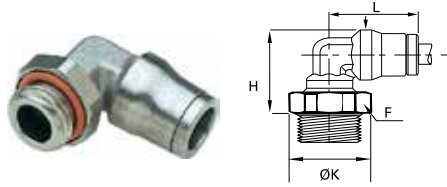

169PLM Male Elbow Tube to BSPP, Metric

| PART NO. | TUBE SIZE MM | BSPP/METRIC | F MM | H MM | K MM | L MM |
|---------------|--------------|-------------|------|-------|-------|-------|
| 169PLM-4M-M5 | 4 | M5X0.8 | 10 | 18.00 | 11.00 | 18.00 |
| 169PLM-4M-2G | 4 | 1/8 | 13 | 17.00 | 14.00 | 18.00 |
| 169PLM-4M-M6 | 4 | M6X1 | 10 | 18.00 | 11.00 | 18.00 |
| 169PLM-4M-4G | 4 | 1/4 | 16 | 17.50 | 17.50 | 18.00 |
| 169PLM-4M-M8 | 4 | M8X1 | 11 | 18.00 | 12.00 | 18.00 |
| 169PLM-6M-M5 | 6 | M5X0.8 | 10 | 20 | 14 | 22 |
| 169PLM-6M-2G | 6 | 1/8 | 13 | 19.00 | 14.00 | 21.50 |
| 169PLM-6M-M10 | 6 | M10X1 | 13 | 19.00 | 14.00 | 21.50 |
| 169PLM-6M-4G | 6 | 1/4 | 16 | 19.50 | 17.50 | 21.50 |
| 169PLM-8M-2G | 8 | 1/8 | 13 | 20.50 | 14.00 | 23.50 |
| 169PLM-8M-4G | 8 | 1/4 | 16 | 21.50 | 17.50 | 23.50 |
| 169PLM-8M-6G | 8 | 3/8 | 20 | 21.50 | 22.00 | 23.50 |
| 169PLM-10M-4G | 10 | 1/4 | 16 | 27.00 | 17.50 | 29.00 |
| 169PLM-10M-6G | 10 | 3/8 | 20 | 25.50 | 22.00 | 29.00 |
| 169PLM-12M-4G | 12 | 1/4 | 16 | 29.50 | 17.50 | 31.00 |
| 169PLM-12M-6G | 12 | 3/8 | 20 | 28.50 | 22.00 | 31.00 |
| 169PLM-12M-8G | 12 | 1/2 | 24 | 28.50 | 26.00 | 31.00 |
| 169PLM-14M-6G | 14 | 3/8 | 20 | 29.00 | 22.00 | 34.00 |
| 169PLM-14M-8G | 14 | 1/2 | 24 | 29.50 | 26.00 | 34.00 |

B

C

D

E

F

G

H

I

J

K

L

M

N

O

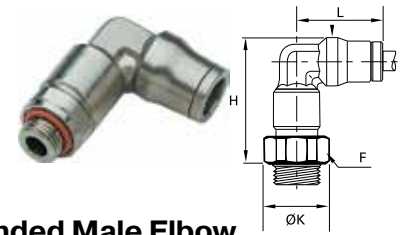

169PLMX Extended Male Elbow Metric Tube to BSPP or M5

| PART NO. | TUBE SIZE MM | BSPP/M5 | F MM | H MM | K MM | L MM |
|----------------|--------------|---------|------|-------|-------|-------|
| 169PLMX-4M-M5 | 4 | M5X0.8 | 10 | 27.50 | 11.00 | 18.00 |
| 169PLMX-4M-2G | 4 | 1/8 | 13 | 25.50 | 14.00 | 18.00 |
| 169PLMX-6M-2G | 6 | 1/8 | 13 | 31.00 | 14.00 | 18.00 |
| 169PLMX-6M-4G | 6 | 1/4 | 16 | 30.50 | 17.50 | 21.50 |
| 169PLMX-8M-2G | 8 | 1/8 | 14 | 33.50 | 15.00 | 23.50 |
| 169PLMX-8M-4G | 8 | 1/4 | 16 | 34.00 | 17.50 | 23.50 |
| 169PLMX-10M-4G | 10 | 1/4 | 18 | 42.00 | 19.50 | 29.00 |
| 169PLMX-10M-6G | 10 | 3/8 | 20 | 41.00 | 22.00 | 29.00 |
| 169PLMX-12M-4G | 12 | 1/4 | 20 | 47.00 | 22.00 | 31.00 |
| 169PLMX-12M-6G | 12 | 3/8 | 20 | 46.00 | 22.00 | 31.00 |
| 169PLMX-14M-8G | 14 | 1/2 | 24 | 49.00 | 26.00 | 34.00 |

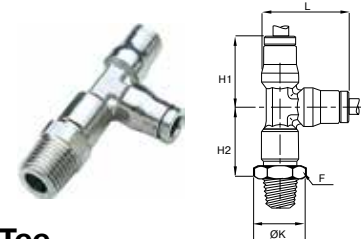

171PLM Male Run Tee Inch Tube to Tube to NPT, UNF

| PART NO. | TUBE SIZE IN | NPT/UNF | F MM | H1 IN | H2 IN | K IN | L IN |
|-------------|--------------|---------|------|-------|-------|------|------|
| 171PLM-4M-2 | 5/32(4MM) | 1/8 | 11 | .71 | .77 | .47 | .91 |
| 171PLM-4-4 | 1/4 | 1/4 | 14 | .87 | .97 | .59 | 1.12 |
| 171PLM-6-4 | 3/8 | 1/4 | 18 | 1.14 | 1.20 | .77 | 1.48 |
| 171PLM-6-6 | 3/8 | 3/8 | 18 | 1.14 | 1.28 | .77 | 1.48 |
| 171PLM-6-8 | 3/8 | 1/2 | 22 | 1.14 | 1.28 | .94 | 1.48 |
| 171PLM-8-6 | 1/2 | 3/8 | 22 | 1.22 | 1.46 | .94 | 1.61 |

169PLMX Extended Male Elbow Metric Tube to BSPT

| PART NO. | TUBE SIZE MM | BSPT | F MM | H MM | K MM | L MM |
|----------------|--------------|------|------|-------|-------|-------|
| 169PLMX-4M-2R | 4 | 1/8 | 10 | 24.50 | 11.00 | 18.00 |
| 169PLMX-6M-2R | 6 | 1/8 | 13 | 29.50 | 14.00 | 21.50 |
| 169PLMX-6M-4R | 6 | 1/4 | 14 | 30.50 | 15.00 | 21.50 |
| 169PLMX-8M-2R | 8 | 1/8 | 14 | 32.50 | 15.00 | 23.50 |
| 169PLMX-8M-4R | 8 | 1/4 | 14 | 34.00 | 15.00 | 23.50 |
| 169PLMX-10M-4R | 10 | 1/4 | 18 | 39.00 | 19.50 | 29.00 |

WARNING These products can expose you to chemicals including LEAD which is known to the state of California to cause cancer and birth defects or other reproductive harm. For more information go to www.P65Warnings.ca.gov.



[Click here for CADs, Product Specifications or to Configure Parts Online](#)

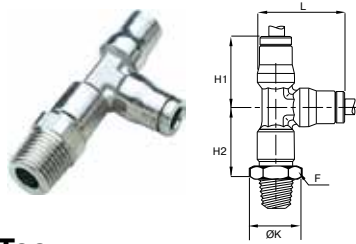

**171PLM Male Run Tee
Metric Tube to Tube to BSPT**

| PART NO. | TUBE SIZE MM | BSPT | F MM | H1 MM | H2 MM | K MM | L MM |
|---------------|--------------|------|------|-------|-------|-------|-------|
| 171PLM-4M-2R | 4 | 1/8 | 10 | 18.00 | 19.50 | 11.00 | 23.00 |
| 171PLM-6M-2R | 6 | 1/8 | 13 | 21.50 | 23.50 | 14.00 | 28.00 |
| 171PLM-6M-4R | 6 | 1/4 | 14 | 21.50 | 24.50 | 15.00 | 28.00 |
| 171PLM-8M-2R | 8 | 1/8 | 14 | 23.50 | 25.00 | 15.00 | 31.00 |
| 171PLM-8M-4R | 8 | 1/4 | 14 | 23.50 | 26.50 | 15.00 | 31.00 |
| 171PLM-10M-4R | 10 | 1/4 | 18 | 29.00 | 30.50 | 19.50 | 37.50 |
| 171PLM-10M-6R | 10 | 3/8 | 18 | 29.00 | 32.50 | 19.50 | 37.50 |
| 171PLM-12M-6R | 12 | 3/8 | 21 | 31.00 | 36.50 | 23.00 | 40.50 |
| 171PLM-14M-8R | 14 | 1/2 | 22 | 34.00 | 40.00 | 24.00 | 45.00 |

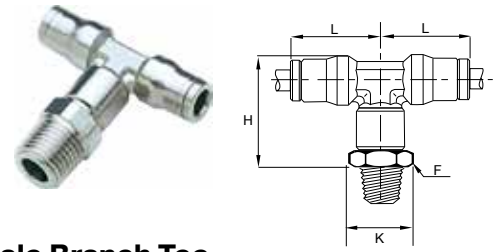

**172PLM Male Branch Tee
Inch Tube to NPT to Tube**

| PART NO. | TUBE SIZE IN | NPT/UNF | F MM | H IN | K IN | L IN |
|-------------|--------------|---------|-------|------|------|------|
| 172PLM-4M-0 | 5/32(4MM) | 10-32 | 10.00 | 1.00 | .47 | .71 |

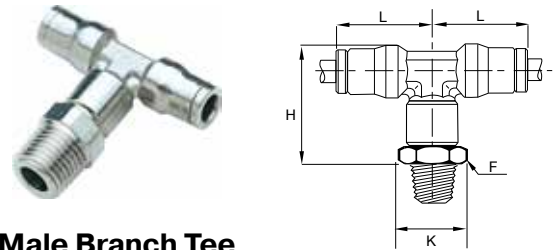

**172PLM Male Branch Tee
Metric Tube to BSPT**

| PART NO. | TUBE SIZE MM | BSPT | F MM | H MM | K MM | L MM |
|---------------|--------------|------|------|-------|-------|-------|
| 172PLM-4M-2R | 4 | 1/8 | 10 | 24.50 | 11.00 | 18.00 |
| 172PLM-6M-2R | 6 | 1/8 | 13 | 29.50 | 14.00 | 21.50 |
| 172PLM-6M-4R | 6 | 1/4 | 14 | 30.50 | 15.00 | 21.50 |
| 172PLM-8M-2R | 8 | 1/8 | 14 | 32.50 | 15.00 | 23.50 |
| 172PLM-8M-4R | 8 | 1/4 | 14 | 34.00 | 15.00 | 23.50 |
| 172PLM-10M-4R | 10 | 1/4 | 18 | 39.00 | 19.50 | 29.00 |
| 172PLM-10M-6R | 10 | 3/8 | 18 | 41.00 | 19.50 | 29.00 |
| 172PLM-12M-6R | 12 | 3/8 | 21 | 46.50 | 23.00 | 31.00 |
| 172PLM-14M-8R | 14 | 1/2 | 22 | 50.50 | 24.00 | 34.00 |

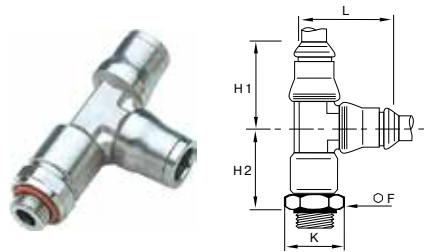

**171PLM Male Run Tee
Tube to Tube to BSPP or M5**

| PART NO. | TUBE SIZE MM | BSPP/M5 | F MM | H1 MM | H2 MM | K MM | L MM |
|---------------|--------------|---------|------|-------|-------|-------|-------|
| 171PLM-4M-M5 | 4 | M5X0.8 | 10 | 18.00 | 22.50 | 11.00 | 23.00 |
| 171PLM-6M-2G | 6 | 1/8 | 13 | 21.50 | 25.00 | 14.00 | 28.00 |
| 171PLM-6M-4G | 6 | 1/4 | 16 | 21.50 | 24.50 | 17.50 | 28.00 |
| 171PLM-8M-2G | 8 | 1/8 | 14 | 23.50 | 26.50 | 15.00 | 31.00 |
| 171PLM-8M-4G | 8 | 1/4 | 16 | 23.50 | 26.50 | 17.50 | 31.00 |
| 171PLM-10M-4G | 10 | 1/4 | 18 | 29.00 | 33.00 | 19.50 | 37.50 |
| 171PLM-12M-6G | 12 | 3/8 | 21 | 31.00 | 36.50 | 23.00 | 40.50 |
| 171PLM-14M-8G | 14 | 1/2 | 24 | 34.00 | 38.50 | 26.00 | 45.00 |

WARNING These products can expose you to chemicals including LEAD which is known to the state of California to cause cancer and birth defects or other reproductive harm. For more information go to www.P65Warnings.ca.gov.



- A
- B
- C
- D
- E
- F
- G
- H
- I
- J
- K
- L
- M
- N
- O

[Click here for CADs, Product Specifications or to Configure Parts Online](#)

- A
- B
- C
- D
- E
- F
- G
- H
- I
- J
- K
- L
- M
- N
- O

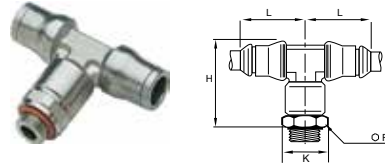

172PLM Male Branch Tee Tube to BSPP or M5

| PART NO. | TUBE SIZE MM | BSPP/M5 | F MM | H MM | K MM | L MM |
|---------------|--------------|---------|------|-------|-------|-------|
| 172PLM-4M-M5 | 4 | M5X0.8 | 10 | 27.50 | 11.00 | 18.00 |
| 172PLM-4M-2G | 4 | 1/8 | 13 | 25.50 | 14.00 | 18.00 |
| 172PLM-6M-2G | 6 | 1/8 | 13 | 31.00 | 14.00 | 21.50 |
| 172PLM-6M-4G | 6 | 1/4 | 16 | 30.50 | 17.50 | 21.50 |
| 172PLM-8M-2G | 8 | 1/8 | 14 | 33.50 | 15.00 | 23.50 |
| 172PLM-8M-4G | 8 | 1/4 | 16 | 34.00 | 17.50 | 23.50 |
| 172PLM-10M-4G | 10 | 1/4 | 18 | 42.00 | 19.50 | 29.00 |
| 172PLM-12M-6G | 12 | 3/8 | 21 | 46.00 | 23.00 | 31.00 |
| 172PLM-14M-8G | 14 | 1/2 | 24 | 49.00 | 26.00 | 34.00 |

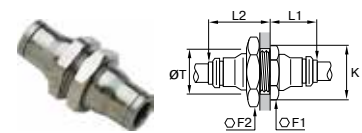

62PLMBH Bulkhead Connector Inch Tube to Tube

| PART NO. | TUBE SIZE IN | F1 MM | F2 MM | K IN | L1 IN | L2 IN | T IN |
|-----------|--------------|-------|-------|------|-------|-------|------|
| 62PLMBH-4 | 1/4 | 16 | 17 | .69 | .67 | .89 | .59 |
| 62PLMBH-6 | 3/8 | 22 | 27 | .95 | .87 | 1.10 | .85 |
| 62PLMBH-8 | 1/2 | 24 | 24 | 1.16 | .89 | 1.14 | 1.04 |

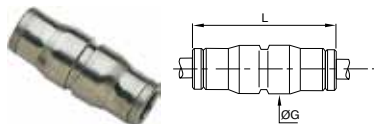

62PLM Straight Union Inch Tube to Tube

| PART NO. | TUBE SIZE IN | G IN | L IN |
|----------|--------------|------|------|
| 62PLM-4 | 1/4 | .49 | 1.44 |
| 62PLM-6 | 3/8 | .67 | 1.87 |
| 62PLM-8 | 1/2 | .79 | 1.89 |

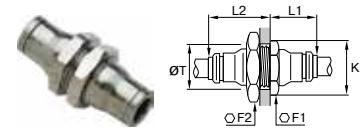

62PLMBH Bulkhead Connector Metric Tube to Tube

| PART NO. | TUBE SIZE MM | F1 MM | F2 MM | K MM | L1 MM | L2 MM | T MM |
|-------------|--------------|-------|-------|-------|-------|-------|-------|
| 62PLMBH-4M | 4MM(5/32) | 13 | 14 | 14.00 | 14.00 | 20.00 | 12.50 |
| 62PLMBH-6M | 6 | 16 | 17 | 17.50 | 17.00 | 22.00 | 15.00 |
| 62PLMBH-8M | 8MM(5/16) | 18 | 19 | 19.50 | 18.50 | 23.50 | 17.00 |
| 62PLMBH-10M | 10 | 22 | 27 | 24.00 | 21.50 | 26.50 | 21.00 |
| 62PLMBH-12M | 12 | 24 | 24 | 26.00 | 23.00 | 27.00 | 23.00 |
| 62PLMBH-14M | 14 | 27 | 27 | 29.50 | 25.50 | 29.50 | 25.00 |

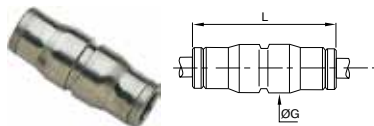

62PLM Straight Union Metric Tube to Tube

| PART NO. | TUBE SIZE MM | G MM | L MM |
|-----------|--------------|-------|-------|
| 62PLM-4M | 4MM(5/32) | 10.00 | 30.50 |
| 62PLM-6M | 6 | 12.00 | 36.50 |
| 62PLM-8M | 8MM(5/16) | 15.00 | 37.50 |
| 62PLM-10M | 10 | 17.50 | 47.50 |
| 62PLM-12M | 12 | 19.50 | 50.00 |
| 62PLM-14M | 14 | 21.50 | 52.50 |

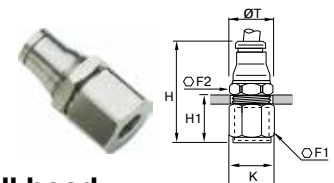

66PLMBH Female Bulkhead Connector Metric Tube to BSPP

| PART NO. | TUBE SIZE MM | BSPP | F1 MM | F2 MM | H MM | H1 MM | K MM | T MM |
|----------------|--------------|------|-------|-------|-------|-------|-------|------|
| 66PLMBH-4M-2G | 4 | 1/8 | 14 | 14 | 30.50 | 11.00 | 15.00 | 13 |
| 66PLMBH-6M-2G | 6 | 1/8 | 17 | 17 | 32.50 | 11.00 | 18.50 | 15 |
| 66PLMBH-6M-4G | 6 | 1/4 | 17 | 17 | 37.00 | 15.00 | 18.50 | 15 |
| 66PLMBH-8M-2G | 8 | 1/8 | 19 | 19 | 34.00 | 10.50 | 21.00 | 17 |
| 66PLMBH-8M-4G | 8 | 1/4 | 19 | 19 | 38.00 | 14.50 | 21.00 | 17 |
| 66PLMBH-10M-6G | 10 | 3/8 | 22 | 27 | 42.50 | 16.00 | 24.00 | 21 |
| 66PLMBH-12M-6G | 12 | 3/8 | 24 | 24 | 43.00 | 16.00 | 26.00 | 23 |
| 66PLMBH-12M-8G | 12 | 1/2 | 27 | 24 | 48.50 | 21.50 | 29.50 | 23 |

WARNING These products can expose you to chemicals including LEAD which is known to the state of California to cause cancer and birth defects or other reproductive harm. For more information go to www.P65Warnings.ca.gov.

[Click here for CADs, Product Specifications or to Configure Parts Online](#)

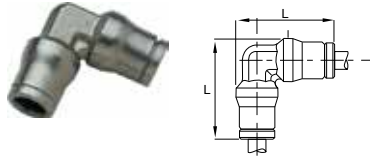

165PLM Union Elbow Inch Tube

| PART NO. | TUBE SIZE IN | L IN |
|----------|--------------|------|
| 165PLM-4 | 1/4 | 1.12 |
| 165PLM-6 | 3/8 | 1.48 |
| 165PLM-8 | 1/2 | 1.61 |

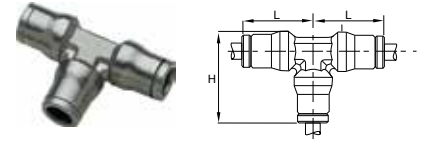

164PLM Union Tee Inch Tube

| PART NO. | TUBE SIZE IN | H IN | L IN |
|----------|--------------|------|------|
| 164PLM-4 | 1/4 | 1.12 | .87 |
| 164PLM-6 | 3/8 | 1.48 | 1.14 |
| 164PLM-8 | 1/2 | 1.61 | 1.22 |

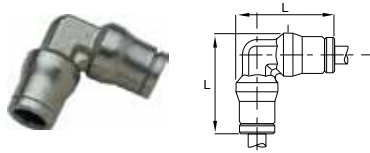

165PLM Union Elbow Metric Tube

| PART NO. | TUBE SIZE MM | L MM |
|------------|--------------|-------|
| 165PLM-4M | 4MM(5/32) | 23.00 |
| 165PLM-6M | 6 | 28.00 |
| 165PLM-8M | 8MM(5/16) | 31.00 |
| 165PLM-10M | 10 | 37.50 |
| 165PLM-12M | 12 | 40.50 |
| 165PLM-14M | 14 | 45.00 |

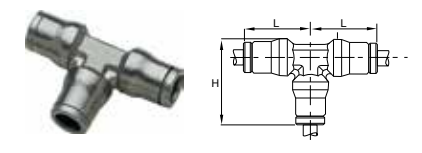

164PLM Union Tee Metric Tube

| PART NO. | TUBE SIZE MM | H MM | L MM |
|------------|--------------|-------|-------|
| 164PLM-4M | 4MM(5/32) | 23.00 | 18.00 |
| 164PLM-6M | 6 | 28.00 | 21.50 |
| 164PLM-8M | 8MM(5/16) | 31.00 | 23.50 |
| 164PLM-10M | 10 | 37.50 | 29.00 |
| 164PLM-12M | 12 | 40.50 | 31.00 |
| 164PLM-14M | 14 | 45.00 | 34.00 |

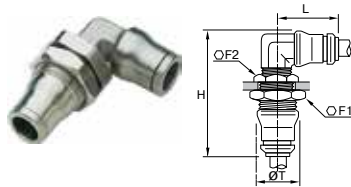

165PLMBH Bulkhead Elbow Metric Tube

| PART NO. | TUBE SIZE MM | F1 MM | F2 MM | H MM | L MM | T MM |
|--------------|--------------|-------|-------|-------|-------|-------|
| 165PLMBH-4M | 4 | 13 | 14 | 35.00 | 18.00 | 12.50 |
| 165PLMBH-6M | 6 | 16 | 17 | 40.50 | 21.50 | 15.00 |
| 165PLMBH-8M | 8 | 18 | 19 | 44.00 | 23.50 | 17.00 |
| 165PLMBH-10M | 10 | 22 | 27 | 51.00 | 29.00 | 21.00 |
| 165PLMBH-12M | 12 | 24 | 24 | 55.00 | 31.00 | 23.00 |
| 165PLMBH-14M | 14 | 27 | 27 | 59.00 | 34.00 | 25.00 |

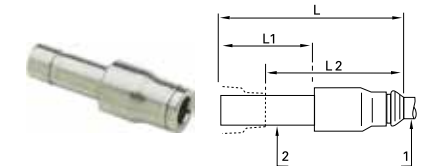

67PLM Plug-In Reducer Metric

| PART NO. | TUBE 1 SIZE MM | TUBE 2 SIZE MM | L MM | L1 MM | L2 MM |
|---------------|----------------|----------------|-------|-------|-------|
| 67PLM-4M-6M | 4 | 6 | 34.50 | 19.00 | 17.50 |
| 67PLM-4M-8M | 4 | 8 | 35.50 | 20.00 | 18.00 |
| 67PLM-6M-8M | 6 | 8 | 37.00 | 20.00 | 19.50 |
| 67PLM-6M-10M | 6 | 10 | 43.50 | 25.00 | 21.00 |
| 67PLM-8M-10M | 8 | 10 | 44.00 | 25.00 | 21.50 |
| 67PLM-8M-12M | 8 | 12 | 45.00 | 26.00 | 21.50 |
| 67PLM-10M-12M | 10 | 12 | 50.00 | 26.00 | 26.50 |
| 67PLM-12M-14M | 12 | 14 | 53.00 | 28.00 | 28.50 |

WARNING These products can expose you to chemicals including LEAD which is known to the state of California to cause cancer and birth defects or other reproductive harm. For more information go to www.P65Warnings.ca.gov.



[Click here for CADs, Product Specifications or to Configure Parts Online](#)

- A
- B
- C
- D
- E
- F
- G
- H
- I
- J
- K
- L
- M
- N
- O

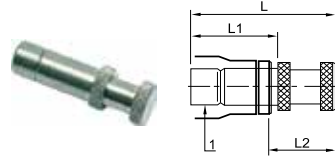

639PLM Plug Metric

| PART NO. | TUBE 1 SIZE MM | L MM | L1 MM | L2 MM |
|------------|----------------|-------|-------|-------|
| 639PLM-4M | 4 | 25.50 | 17.00 | 11.50 |
| 639PLM-6M | 6 | 30.50 | 19.50 | 13.50 |
| 639PLM-8M | 8 | 33.00 | 20.00 | 16.00 |
| 639PLM-10M | 10 | 40.00 | 25.00 | 18.00 |
| 639PLM-12M | 12 | 43.00 | 26.00 | 20.00 |
| 639PLM-14M | 14 | 47.00 | 28.00 | 22.50 |

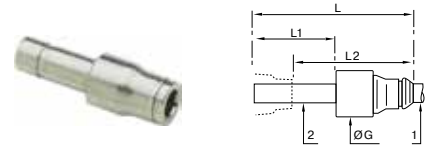

62PLMSP Plug-In Expander Metric

| PART NO. | TUBE 1 SIZE MM | TUBE 2 SIZE MM | G MM | L MM | L1 MM | L2 MM |
|-------------|----------------|----------------|------|------|-------|-------|
| 62PLMSP-4-6 | 6 | 4 | 17 | 42 | 22 | 28 |

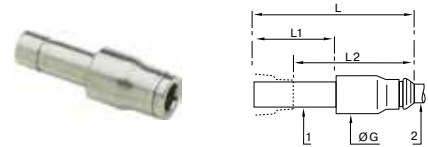

62PLMSP Plug-In Metric/Inch Adapter

| PART NO. | TUBE 1 SIZE MM | TUBE 2 SIZE IN | G MM | L MM | L1 MM | L2 MM |
|---------------|----------------|----------------|-------|-------|-------|-------|
| 62PLMSP-4-6M | 6 | 1/4 | 12.50 | 38.00 | 19.00 | 20.50 |
| 62PLMSP-6-10M | 10 | 3/8 | 17.00 | 49.50 | 25.00 | 27.00 |
| 62PLMSP-8-12M | 12 | 1/2 | 20.00 | 51.00 | 26.00 | 27.50 |

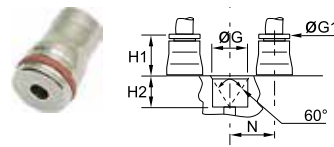

PLMC Cartridge

| PART NO. | TUBE SIZE MM | G +.1 - 0 | H1 MM | H2 MM | N MM |
|----------|--------------|-----------|-------|-------|-------|
| PLMC-4M | 4 | 10.00 | 9.00 | 8.50 | 11.00 |
| PLMC-6M | 6 | 12.00 | 11.00 | 8.50 | 13.50 |
| PLMC-8M | 8 | 15.00 | 12.50 | 8.50 | 16.00 |
| PLMC-10M | 10 | 17.50 | 14.50 | 10.50 | 20.00 |
| PLMC-12M | 12 | 19.50 | 15.00 | 10.50 | 22.50 |
| PLMC-14M | 14 | 21.50 | 16.50 | 12.00 | 25.00 |

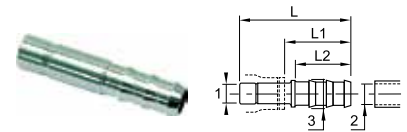

122PLMSP Plug-In Barbed Connector Metric

| PART NO. | TUBE 1 SIZE MM | TUBE 2 SIZE MM | TUBE 3 SIZE MM | L MM | L1 MM | L2 MM |
|-----------------|----------------|----------------|----------------|-------|-------|-------|
| 122PLMSP-4M-3M | 4 | 3.20 | 5.00 | 40.50 | 27.00 | 22.50 |
| 122PLMSP-4M-5M | 4 | 5.00 | 7.00 | 40.50 | 27.00 | 22.50 |
| 122PLMSP-6M-5M | 6 | 5.00 | 7.00 | 43.00 | 27.00 | 22.50 |
| 122PLMSP-8M-6M | 8 | 6.30 | 8.30 | 42.00 | 25.00 | 22.50 |
| 122PLMSP-8M-8M | 8 | 8.00 | 10.00 | 44.00 | 27.00 | 22.50 |
| 122PLMSP-10M-6M | 10 | 6.30 | 8.30 | 47.50 | 25.50 | 22.50 |
| 122PLMSP-10M-8M | 10 | 8.00 | 10.00 | 47.50 | 25.50 | 22.50 |
| 122PLMSP-12M-8M | 12 | 8.00 | 10.00 | 48.50 | 25.50 | 22.50 |
| 122PLMSP-12M10M | 12 | 10.00 | 12.00 | 48.50 | 25.50 | 22.50 |
| 122PLMSP-12M12M | 12 | 12.50 | 14.50 | 57.00 | 34.00 | 29.50 |
| 122PLMSP-14M12M | 14 | 12.50 | 14.50 | 57.50 | 33.00 | 29.50 |
| 122PLMSP-14M14M | 14 | 14.00 | 16.00 | 59.50 | 35.00 | 29.50 |

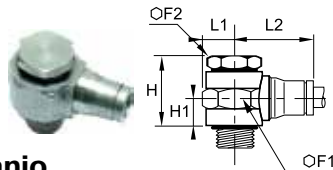

169PLMBJ Single Banjo Metric Tube to BSPP or M5

| PART NO. | TUBE SIZE MM | BSPP/M5 | F1 MM | F2 MM | H MM | H1 MM | L1 MM | L2 MM |
|-----------------|--------------|---------|-------|-------|-------|-------|-------|-------|
| 169PLMBJ-4M-M5 | 4 | M5X0.8 | 10 | 8 | 14.50 | 6.50 | 6.00 | 18.50 |
| 169PLMBJ-4M-2G | 4 | G1/8 | 17 | 14 | 23.00 | 9.50 | 10.00 | 20.50 |
| 169PLMBJ-6M-M5 | 6 | M5X0.8 | 10 | 8 | 15.00 | 7.00 | 6.00 | 22.50 |
| 169PLMBJ-6M-2G | 6 | G1/8 | 17 | 14 | 23.00 | 9.50 | 10.00 | 23.50 |
| 169PLMBJ-6M-4G | 6 | G1/4 | 22 | 17 | 22.00 | 9.00 | 13.00 | 25.50 |
| 169PLMBJ-8M-2G | 8 | G1/8 | 17 | 14 | 23.00 | 9.50 | 10.00 | 26.00 |
| 169PLMBJ-8M-4G | 8 | G1/4 | 22 | 17 | 22.00 | 9.00 | 13.00 | 27.50 |
| 169PLMBJ-10M-6G | 10 | G3/8 | 22 | 22 | 33.00 | 14.00 | 13.00 | 32.00 |



63PLM Double Male Union Metric

| PART NO. | TUBE SIZE MM | L MM | L1 MM |
|-----------|--------------|-------|-------|
| 63PLM-4M | 4 | 31.00 | 14.00 |
| 63PLM-6M | 6 | 36.50 | 17.00 |
| 63PLM-8M | 8 | 37.50 | 17.50 |
| 63PLM-10M | 10 | 47.50 | 22.50 |
| 63PLM-12M | 12 | 49.50 | 23.50 |
| 63PLM-14M | 14 | 53.00 | 25.00 |

WARNING These products can expose you to chemicals including LEAD which is known to the state of California to cause cancer and birth defects or other reproductive harm. For more information go to www.P65Warnings.ca.gov.



Prestolok PLS Stainless Steel Push-to-Connect Fittings

Parker's Prestolok PLS fittings are ideal for conveying corrosive fluids in aggressive environments. Prestolok PLS fittings provide corrosion resistance and a hygienic external design.

Product Features:

- Stainless steel 316L collet
- Stainless steel 316L body
- FKM seal
- Stainless steel 316L backup washer
- Chemical, corrosion, and abrasion resistance
- Hygienic design reduces retention zones for easy cleaning
- NPT, BSPT, BSPP, and metric threads
- Silicone Free

Markets:

- Petrochemical
- Life Science
- Pulp and Paper
- Food Processing
- Wash Down

Compatible Media:

- Food Fluids
- Chemicals
- Cleaning Agents
- Compressed Air
- Inert Gases

Specifications:

| | |
|--------------------------|---|
| Pressure Range | Up to 435 psi (30 bar) 290 psi (19.9 bar) for 169PLS |
| Temperature Range | -13° to +302° F (-25° to +150° C) |
| Vacuum Rating | 28" Hg |

Note: Maximum pressure and temperature range depend on the type of tubing used.

Compatible Tubing:

- Semi-rigid nylon
- Polyethylene
- Polyurethane 95 Durometer Shore A
- Stainless Steel (grooved)
- Copper (grooved)
- FEP

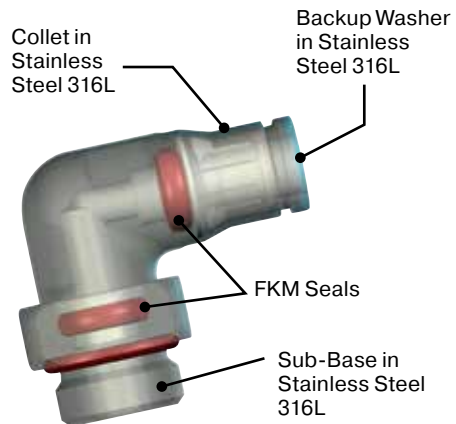

Assembly Instructions

1. Cut tubing squarely – maximum of 15° angle allowable.
2. Check that port or mating part is clean and free of debris.
3. Mark tubing to appropriate tube insertion length. (see Tube Insertion Chart on page N22)
4. Insert tubing until it bottoms
5. Pull on tubing to verify it is fully inserted
6. To disassemble, simply press release button, hold against body and pull tubing out of fitting.

WARNING These products can expose you to chemicals including NICKEL, which is known to the state of California to cause cancer. For more information go to www.P65Warnings.ca.gov.



- A
- B
- C
- D
- E
- F
- G
- H
- I
- J
- K
- L
- M
- N
- O

■ **Threaded Fittings**

68PLS

Male Connector
NPT, BSPT
p. A55



68PLS

Male Connector
BSPP
p. A55



169PLS

Male Elbow
NPT, BSPT
p. A57



169PLS

Male Elbow
BSPP
p. A57



169PLSX

Extended Male
Elbow – NPT, BSPT
p. A58



169PLSX

Extended Male
Elbow – BSPP
p. A58



■ **Tube to Tube Fittings**

62PLS

Union
p. A58



165PLS

Union Elbow
p. A59



164PLS

Union Tee
p. A59



■ **Bulkhead Union**

62PLSBH

Bulkhead Union
p. A59



■ **Standpipes**

68PLSSP

Male Standpipe
NPT, BSPT
p. A56



68PLSSP

Male Standpipe
BSPP
p. A56



■ **Plug-In Fittings & Accessories**

67PLS

Tube Reducer
p. A60



639PLS

Plug
p. A60



PLSC

Cartridge
p. A60



WARNING These products can expose you to chemicals including NICKEL, which is known to the state of California to cause cancer. For more information go to www.P65Warnings.ca.gov.

Click here for CADs, Product Specifications or to Configure Parts Online

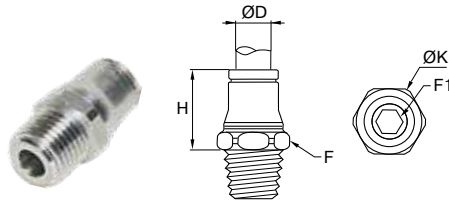

68PLS Male Connector - Inch Tube to NPT, UNF

| PART NO. | TUBE SIZE IN | NPT / UNF | F MM | F1 MM | H IN | K IN |
|------------|--------------|-----------|------|-------|------|------|
| 68PLS-4M-0 | 5/32(4MM) | 10-32 | 10 | 2.5 | .59 | .43 |
| 68PLS-3-2 | 3/16 | 1/8 | 10 | 3 | .61 | .43 |
| 68PLS-4-2 | 1/4 | 1/8 | 13 | 4 | .75 | .55 |
| 68PLS-4-4 | 1/4 | 1/4 | 14 | 4 | .69 | .59 |
| 68PLS-6-4 | 3/8 | 1/4 | 19 | 6 | .98 | .83 |
| 68PLS-6-6 | 3/8 | 3/8 | 19 | 7 | .94 | .83 |
| 68PLS-8-4 | 1/2 | 1/4 | 22 | 7 | 1.02 | .94 |
| 68PLS-8-6 | 1/2 | 3/8 | 22 | 8 | .98 | .94 |
| 68PLS-8-8 | 1/2 | 1/2 | 22 | 10 | .98 | .94 |

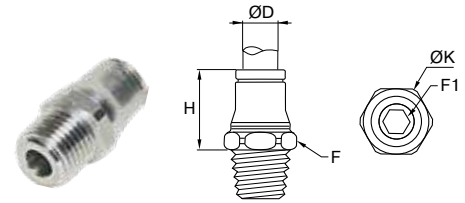

68PLS Male Connector - Metric Tube to BSPT

| PART NO. | TUBE SIZE MM | BSPT | F MM | F1 MM | H MM | K MM |
|--------------|--------------|------|------|-------|-------|-------|
| 68PLS-4M-2R | 4 | 1/8 | 10 | 3 | 14.50 | 11.00 |
| 68PLS-4M-4R | 4 | 1/4 | 14 | 3 | 14.50 | 15.00 |
| 68PLS-6M-2R | 6 | 1/8 | 13 | 4 | 18.00 | 14.00 |
| 68PLS-6M-4R | 6 | 1/4 | 14 | 4 | 16.50 | 15.00 |
| 68PLS-8M-2R | 8 | 1/8 | 15 | 5 | 20.50 | 16.50 |
| 68PLS-8M-4R | 8 | 1/4 | 15 | 5 | 19.00 | 16.50 |
| 68PLS-8M-6R | 8 | 3/8 | 17 | 6 | 19.00 | 18.50 |
| 68PLS-10M-4R | 10 | 1/4 | 19 | 6 | 24.00 | 21.00 |
| 68PLS-10M-6R | 10 | 3/8 | 19 | 7 | 22.50 | 21.00 |
| 68PLS-12M-4R | 12 | 1/4 | 22 | 7 | 25.00 | 24.00 |
| 68PLS-12M-6R | 12 | 3/8 | 22 | 8 | 24.00 | 24.00 |
| 68PLS-12M-8R | 12 | 1/2 | 22 | 10 | 23.00 | 24.00 |

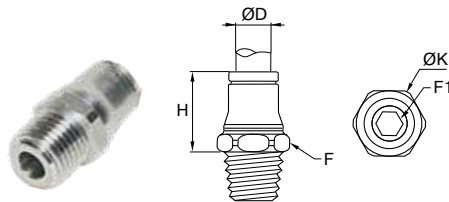

68PLS Male Connector - Metric Tube to NPT

| PART NO. | TUBE SIZE MM | NPT | F MM | F1 MM | H MM | K MM |
|-------------|--------------|-----|------|-------|-------|-------|
| 68PLS-4M-2 | 4MM(5/32) | 1/8 | 11 | 3 | 14.50 | 12.00 |
| 68PLS-6M-2 | 6 | 1/8 | 13 | 4 | 18.00 | 14.00 |
| 68PLS-6M-4 | 6 | 1/4 | 14 | 4 | 16.50 | 15.00 |
| 68PLS-8M-2 | 8MM(5/16) | 1/8 | 15 | 5 | 19.00 | 16.50 |
| 68PLS-8M-4 | 8MM(5/16) | 1/4 | 15 | 6 | 18.00 | 16.50 |
| 68PLS-10M-4 | 10 | 1/4 | 19 | 6 | 24.00 | 21.00 |
| 68PLS-10M-6 | 10 | 3/8 | 19 | 7 | 22.50 | 21.00 |
| 68PLS-12M-4 | 12 | 1/4 | 22 | 7 | 25.00 | 24.00 |
| 68PLS-12M-6 | 12 | 3/8 | 22 | 8 | 24.00 | 24.00 |
| 68PLS-12M-8 | 12 | 1/2 | 22 | 10 | 23.00 | 24.00 |

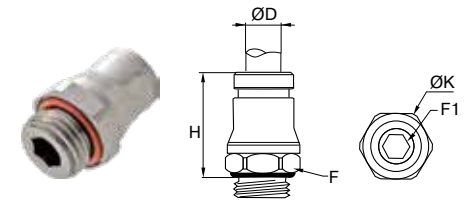

68PLS Male Connector - Metric Tube to BSPP, M5

| PART NO. | TUBE SIZE MM | BSPP / M5 | F MM | F1 MM | H MM | K MM |
|--------------|--------------|-----------|------|-------|-------|-------|
| 68PLS-4M-M5 | 4 | M5X0.8 | 10 | 2.5 | 16.00 | 11.00 |
| 68PLS-4M-2G | 4 | 1/8 | 13 | 3 | 15.00 | 14.00 |
| 68PLS-6M-M5 | 6 | M5X0.8 | 13 | 2.5 | 20.50 | 14.00 |
| 68PLS-6M-2G | 6 | 1/8 | 13 | 4 | 18.00 | 14.00 |
| 68PLS-6M-4G | 6 | 1/4 | 17 | 4 | 18.00 | 18.50 |
| 68PLS-8M-2G | 8 | 1/8 | 15 | 5 | 19.00 | 16.50 |
| 68PLS-8M-4G | 8 | 1/4 | 17 | 5 | 20.50 | 18.50 |
| 68PLS-8M-6G | 8 | 3/8 | 21 | 6 | 20.00 | 23.00 |
| 68PLS-10M-4G | 10 | 1/4 | 18 | 7 | 25.00 | 19.50 |
| 68PLS-10M-6G | 10 | 3/8 | 21 | 7 | 25.00 | 23.00 |
| 68PLS-12M-4G | 12 | 1/4 | 21 | 7 | 27.00 | 23.00 |
| 68PLS-12M-6G | 12 | 3/8 | 21 | 9 | 26.50 | 23.00 |

WARNING These products can expose you to chemicals including NICKEL, which is known to the state of California to cause cancer. For more information go to www.P65Warnings.ca.gov.



[Click here for CADs, Product Specifications or to Configure Parts Online](#)

- A
- B
- C
- D
- E
- F
- G
- H
- I
- J
- K
- L
- M
- N
- O

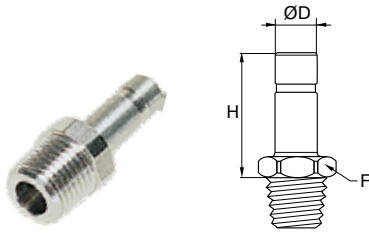

68PLSSP Male Standpipe - Inch Tube to NPT

| PART NO. | TUBE SIZE IN | NPT | F IN | H IN |
|-------------|--------------|-----|------|------|
| 68PLSSP-4-2 | 1/4 | 1/8 | 0.39 | 1.02 |
| 68PLSSP-4-4 | 1/4 | 1/4 | 0.55 | 1.06 |
| 68PLSSP-6-4 | 3/8 | 1/4 | 0.75 | 1.26 |
| 68PLSSP-6-6 | 3/8 | 3/8 | 0.75 | 1.26 |
| 68PLSSP-8-4 | 1/2 | 1/4 | 0.75 | 1.42 |
| 68PLSSP-8-6 | 1/2 | 3/8 | 0.75 | 1.46 |
| 68PLSSP-8-8 | 1/2 | 1/2 | 0.87 | 1.46 |

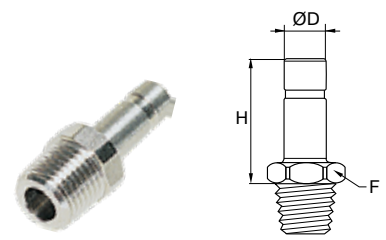

68PLSSP Male Standpipe - Metric Tube to BSPT

| PART NO. | TUBE SIZE MM | BSPT | F MM | H MM |
|----------------|--------------|------|------|------|
| 68PLSSP-4M-2R | 4 | 1/8 | 10 | 21 |
| 68PLSSP-6M-2R | 6 | 1/8 | 10 | 23 |
| 68PLSSP-6M-4R | 6 | 1/4 | 14 | 24 |
| 68PLSSP-8M-2R | 8 | 1/8 | 10 | 24 |
| 68PLSSP-8M-4R | 8 | 1/4 | 14 | 25 |
| 68PLSSP-10M-4R | 10 | 1/4 | 14 | 30 |
| 68PLSSP-10M-6R | 10 | 3/8 | 17 | 30 |
| 68PLSSP-12M-4R | 12 | 1/4 | 14 | 31 |
| 68PLSSP-12M-6R | 12 | 3/8 | 17 | 31 |
| 68PLSSP-12M-8R | 12 | 1/2 | 22 | 32 |

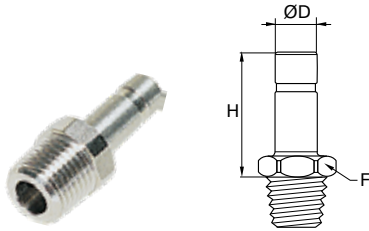

68PLSSP Male Standpipe - Metric Tube to NPT

| PART NO. | TUBE SIZE MM | NPT | F MM | H MM |
|---------------|--------------|-----|------|------|
| 68PLSSP-4M-2 | 4MM(5/32) | 1/8 | 11 | 21 |
| 68PLSSP-6M-2 | 6 | 1/8 | 11 | 23 |
| 68PLSSP-6M-4 | 6 | 1/4 | 14 | 24 |
| 68PLSSP-8M-2 | 8MM(5/16) | 1/8 | 14 | 24 |
| 68PLSSP-8M-4 | 8MM(5/16) | 1/4 | 14 | 25 |
| 68PLSSP-10M-4 | 10 | 1/4 | 14 | 30 |
| 68PLSSP-10M-6 | 10 | 3/8 | 17 | 30 |

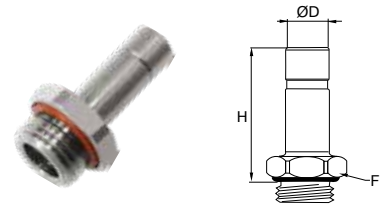

68PLSSP Male Standpipe - Metric Tube to BSPP, M5

| PART NO. | TUBE SIZE MM | BSPP / M5 | F MM | H MM |
|----------------|--------------|-----------|------|-------|
| 68PLSSP-4M-M5 | 4 | M5X0.8 | 7 | 23.50 |
| 68PLSSP-4M-2G | 4 | 1/8 | 13 | 22.00 |
| 68PLSSP-6M-2G | 6 | 1/8 | 13 | 24.00 |
| 68PLSSP-6M-4G | 6 | 1/4 | 17 | 24.00 |
| 68PLSSP-8M-2G | 8 | 1/8 | 13 | 25.00 |
| 68PLSSP-8M-4G | 8 | 1/4 | 17 | 27.00 |
| 68PLSSP-8M-6G | 8 | 3/8 | 21 | 27.00 |
| 68PLSSP-10M-4G | 10 | 1/4 | 17 | 32.00 |
| 68PLSSP-10M-6G | 10 | 3/8 | 21 | 27.00 |
| 68PLSSP-12M-4G | 12 | 1/4 | 17 | 33.00 |
| 68PLSSP-12M-6G | 12 | 3/8 | 21 | 33.00 |

WARNING These products can expose you to chemicals including NICKEL, which is known to the state of California to cause cancer. For more information go to www.P65Warnings.ca.gov.



[Click here for CADs, Product Specifications or to Configure Parts Online](#)

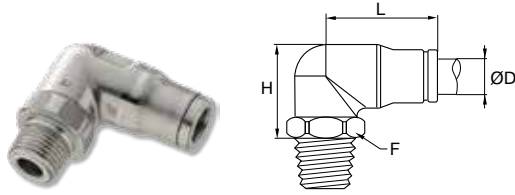

169PLS Male Elbow - Inch Tube to NPT, UNF

| PART NO. | TUBE SIZE IN | NPT / UNF | F MM | H IN | L IN |
|-------------|--------------|-----------|------|------|------|
| 169PLS-4M-0 | 5/32(4MM) | 10-32 | 10 | .98 | .77 |
| 169PLS-4-2 | 1/4 | 1/8 | 13 | .85 | .91 |
| 169PLS-4-4 | 1/4 | 1/4 | 14 | .85 | .91 |
| 169PLS-6-4 | 3/8 | 1/4 | 17 | 1.12 | 1.20 |
| 169PLS-6-6 | 3/8 | 3/8 | 19 | 1.12 | 1.20 |
| 169PLS-8-4 | 1/2 | 1/4 | 22 | 1.34 | 1.30 |
| 169PLS-8-6 | 1/2 | 3/8 | 22 | 1.34 | 1.30 |
| 169PLS-8-8 | 1/2 | 1/2 | 22 | 1.34 | 1.30 |

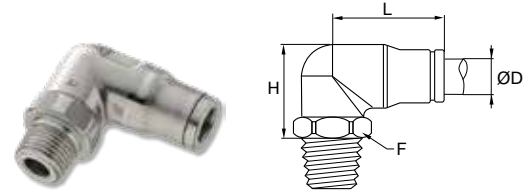

169PLS Male Elbow - Metric Tube to BSPT

| PART NO. | TUBE SIZE MM | BSPT | F MM | H MM | L MM |
|---------------|--------------|------|------|-------|-------|
| 169PLS-4M-2R | 4 | 1/8 | 13 | 18.00 | 19.00 |
| 169PLS-4M-4R | 4 | 1/4 | 14 | 18.00 | 19.00 |
| 169PLS-6M-2R | 6 | 1/8 | 13 | 20.00 | 24.00 |
| 169PLS-6M-4R | 6 | 1/4 | 14 | 20.00 | 23.00 |
| 169PLS-8M-2R | 8 | 1/8 | 13 | 24.50 | 32.00 |
| 169PLS-8M-4R | 8 | 1/4 | 14 | 23.50 | 24.00 |
| 169PLS-8M-6R | 8 | 3/8 | 19 | 23.00 | 25.00 |
| 169PLS-10M-4R | 10 | 1/4 | 17 | 27.00 | 31.00 |
| 169PLS-10M-6R | 10 | 3/8 | 19 | 26.00 | 31.00 |
| 169PLS-12M-4R | 12 | 1/4 | 22 | 31.50 | 33.00 |
| 169PLS-12M-6R | 12 | 3/8 | 22 | 32.50 | 33.00 |
| 169PLS-12M-8R | 12 | 1/2 | 22 | 27.50 | 33.00 |

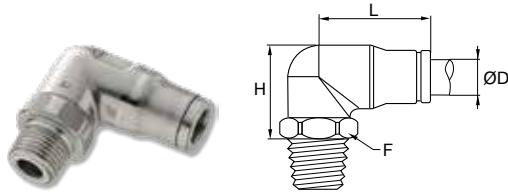

169PLS Male Elbow - Metric Tube to NPT

| PART NO. | TUBE SIZE MM | NPT | F MM | H MM | L MM |
|--------------|--------------|-----|------|-------|-------|
| 169PLS-6M-2 | 6 | 1/8 | 13 | 20.00 | 22.50 |
| 169PLS-6M-4 | 6 | 1/4 | 14 | 20.00 | 22.50 |
| 169PLS-8M-2 | 8MM(5/16) | 1/8 | 13 | 25.00 | 24.00 |
| 169PLS-8M-4 | 8MM(5/16) | 1/4 | 14 | 24.00 | 24.00 |
| 169PLS-10M-4 | 10 | 1/4 | 17 | 27.50 | 27.50 |
| 169PLS-10M-6 | 10 | 3/8 | 19 | 28.50 | 26.50 |
| 169PLS-12M-4 | 12 | 1/4 | 22 | 31.50 | 32.50 |
| 169PLS-12M-6 | 12 | 3/8 | 22 | 32.50 | 32.50 |
| 169PLS-12M-8 | 12 | 1/2 | 22 | 27.50 | 32.50 |

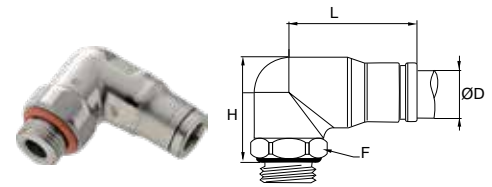

169PLS Male Elbow - Metric Tube to BSPP

| PART NO. | TUBE SIZE MM | BSPP | F MM | H MM | L MM |
|---------------|--------------|------|------|------|------|
| 169PLS-4M-2G | 4 | 1/8 | 10 | 22 | 19 |
| 169PLS-4M-4G | 4 | 1/4 | 17 | 20 | 19 |
| 169PLS-6M-2G | 6 | 1/8 | 13 | 24 | 24 |
| 169PLS-6M-4G | 6 | 1/4 | 17 | 22 | 24 |
| 169PLS-8M-2G | 8 | 1/8 | 13 | 25 | 25 |
| 169PLS-8M-4G | 8 | 1/4 | 17 | 25 | 25 |
| 169PLS-8M-6G | 8 | 3/8 | 21 | 23 | 25 |
| 169PLS-10M-4G | 10 | 1/4 | 18 | 29 | 31 |
| 169PLS-10M-6G | 10 | 3/8 | 21 | 27 | 31 |
| 169PLS-12M-4G | 12 | 1/4 | 17 | 33 | 33 |
| 169PLS-12M-6G | 12 | 3/8 | 21 | 33 | 33 |
| 169PLS-12M-8G | 12 | 1/2 | 24 | 30 | 33 |

WARNING These products can expose you to chemicals including NICKEL, which is known to the state of California to cause cancer. For more information go to www.P65Warnings.ca.gov.



- A
- B
- C
- D
- E
- F
- G
- H
- I
- J
- K
- L
- M
- N
- O

Click here for CADs, Product Specifications or to Configure Parts Online

A

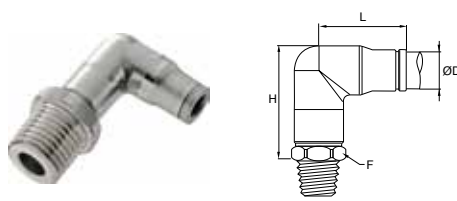

169PLSX Extended Male Elbow - Metric Tube to NPT

| PART NO. | TUBE SIZE MM | NPT | F MM | H MM | L MM |
|---------------|--------------|-----|------|------|------|
| 169PLSX-6M-2 | 6 | 1/8 | 13 | 29 | 22.5 |
| 169PLSX-6M-4 | 6 | 1/4 | 14 | 29 | 22.5 |
| 169PLSX-8M-2 | 8 | 1/8 | 14 | 34 | 24 |
| 169PLSX-8M-4 | 8 | 1/4 | 14 | 34 | 24 |
| 169PLSX-10M-4 | 10 | 1/4 | 19 | 39.5 | 30 |
| 169PLSX-10M-6 | 10 | 3/8 | 19 | 39.5 | 30 |

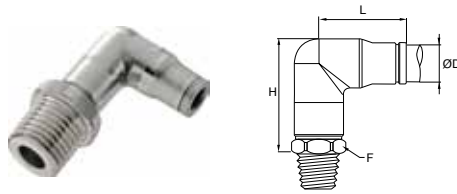

169PLSX Extended Male Elbow - Metric Tube to BSPT

| PART NO. | TUBE SIZE MM | BSPT | F MM | H MM | L MM |
|----------------|--------------|------|------|------|-------|
| 169PLSX-4M-2R | 4 | 1/8 | 10 | 25 | 19.00 |
| 169PLSX-6M-2R | 6 | 1/8 | 13 | 30 | 24.00 |
| 169PLSX-6M-4R | 6 | 1/4 | 14 | 30 | 24.00 |
| 169PLSX-8M-2R | 8 | 1/8 | 14 | 34 | 24.90 |
| 169PLSX-8M-4R | 8 | 1/4 | 14 | 34 | 24.90 |
| 169PLSX-10M-4R | 10 | 1/4 | 19 | 39 | 31.00 |
| 169PLSX-10M-6R | 10 | 3/8 | 19 | 39 | 31.00 |

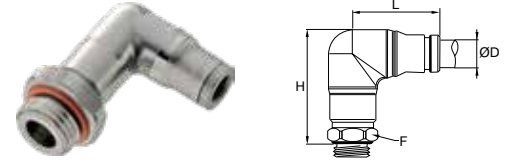

169PLSX Extended Male Elbow - Metric Tube to BSPP, M5

| PART NO. | TUBE SIZE MM | BSPP / M5 | F MM | H MM | L MM |
|----------------|--------------|-----------|------|-------|------|
| 169PLSX-4M-M5 | 4 | M5X0.8 | 10 | 27.00 | 19 |
| 169PLSX-4M-2G | 4 | 1/8 | 13 | 27.00 | 19 |
| 169PLSX-4M-4G | 4 | 1/4 | 17 | 27.00 | 19 |
| 169PLSX-6M-M5 | 6 | M5X0.8 | 13 | 33.00 | 24 |
| 169PLSX-6M-2G | 6 | 1/8 | 13 | 33.00 | 24 |
| 169PLSX-6M-4G | 6 | 1/4 | 17 | 32.00 | 24 |
| 169PLSX-8M-2G | 8 | 1/8 | 14 | 35.00 | 25 |
| 169PLSX-8M-4G | 8 | 1/4 | 17 | 35.00 | 25 |
| 169PLSX-8M-6G | 8 | 3/8 | 21 | 34.50 | 25 |
| 169PLSX-10M-4G | 10 | 1/4 | 18 | 43.00 | 31 |
| 169PLSX-10M-6G | 10 | 3/8 | 21 | 42.00 | 31 |

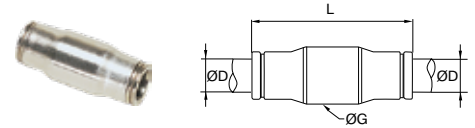

62PLS Union - Inch Tube

| PART NO. | TUBE SIZE IN | G IN | H IN |
|----------|--------------|------|------|
| 62PLS-3 | 3/16 | .39 | 1.18 |
| 62PLS-4 | 1/4 | .47 | 1.38 |
| 62PLS-6 | 3/8 | .69 | 1.81 |
| 62PLS-8 | 1/2 | .79 | 1.89 |

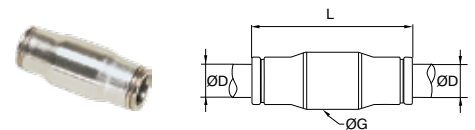

62PLS Union - Metric Tube

| PART NO. | TUBE SIZE MM | G MM | H MM |
|-----------|--------------|-------|-------|
| 62PLS-4M | 4MM(5/32) | 10.00 | 30.00 |
| 62PLS-6M | 6 | 12.00 | 37.00 |
| 62PLS-8M | 8MM(5/16) | 15.00 | 38.00 |
| 62PLS-10M | 10 | 17.00 | 49.00 |
| 62PLS-12M | 12 | 19.50 | 49.50 |

WARNING These products can expose you to chemicals including NICKEL, which is known to the state of California to cause cancer. For more information go to www.P65Warnings.ca.gov.



B

C

D

E

F

G

H

I

J

K

L

M

N

O

[Click here for CADs, Product Specifications or to Configure Parts Online](#)

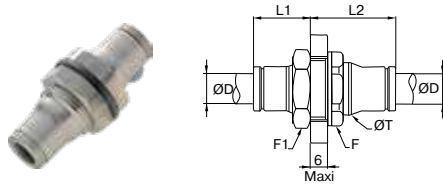

62PLSBH Bulkhead Union - Inch Tube

| PART NO. | TUBE SIZE IN | F MM | F1 MM | L1 IN | L2 IN | T IN |
|-----------|--------------|------|-------|-------|-------|------|
| 62PLSBH-3 | 3/16 | 17 | 13 | .59 | .83 | .49 |
| 62PLSBH-4 | 1/4 | 19 | 17 | .67 | .89 | .59 |
| 62PLSBH-6 | 3/8 | 27 | 22 | .87 | 1.08 | .82 |
| 62PLSBH-8 | 1/2 | 27 | 27 | .94 | 1.14 | .98 |

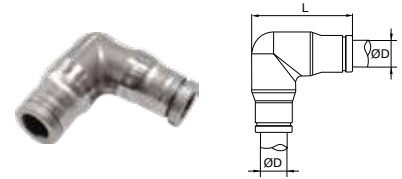

165PLS Union Elbow - Metric Tube

| PART NO. | TUBE SIZE MM | L MM |
|------------|--------------|-------|
| 165PLS-4M | 4MM(5/32) | 24.00 |
| 165PLS-6M | 6 | 30.00 |
| 165PLS-8M | 8MM(5/16) | 32.20 |
| 165PLS-10M | 10 | 39.00 |
| 165PLS-12M | 12 | 43.00 |

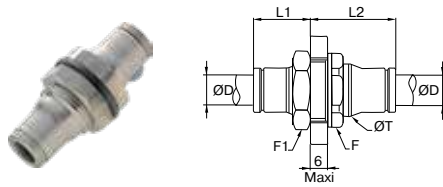

62PLSBH Bulkhead Union - Metric Tube

| PART NO. | TUBE SIZE MM | F MM | F1 MM | L1 MM | L2 MM | T MM |
|-------------|--------------|------|-------|-------|-------|------|
| 62PLSBH-4M | 4MM(5/32) | 14 | 13 | 15 | 18 | 13 |
| 62PLSBH-6M | 6 | 17 | 17 | 19 | 21 | 15 |
| 62PLSBH-8M | 8MM(5/16) | 19 | 19 | 20 | 22 | 17 |
| 62PLSBH-10M | 10 | 22 | 22 | 24 | 26 | 21 |
| 62PLSBH-12M | 12 | 24 | 24 | 25 | 26 | 23 |

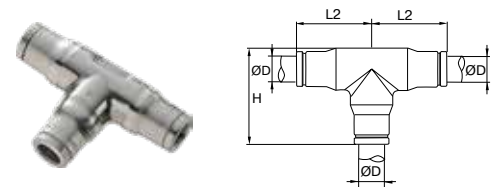

164PLS Union Tee - Inch Tube

| PART NO. | TUBE SIZE IN | H IN | L2 IN |
|----------|--------------|------|-------|
| 164PLS-4 | 1/4 | 1.06 | .83 |
| 164PLS-6 | 3/8 | 1.48 | 1.12 |
| 164PLS-8 | 1/2 | 1.61 | 1.22 |

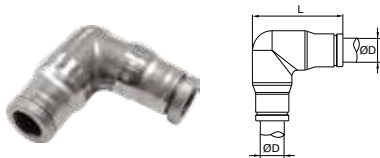

165PLS Union Elbow - Inch Tube

| PART NO. | TUBE SIZE IN | L IN |
|----------|--------------|------|
| 165PLS-4 | 1/4 | 1.14 |
| 165PLS-6 | 3/8 | 1.56 |
| 165PLS-8 | 1/2 | 1.61 |

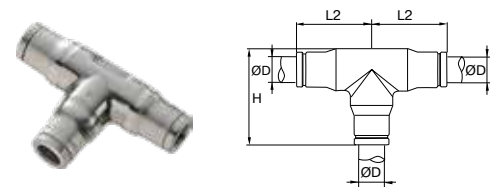

164PLS Union Tee - Metric Tube

| PART NO. | TUBE SIZE MM | H MM | L2 MM |
|------------|--------------|------|-------|
| 164PLS-4M | 4MM(5/32) | 24 | 19 |
| 164PLS-6M | 6 | 30 | 24 |
| 164PLS-8M | 8MM(5/16) | 32 | 25 |
| 164PLS-10M | 10 | 39 | 31 |
| 164PLS-12M | 12 | 43 | 33 |

WARNING These products can expose you to chemicals including NICKEL, which is known to the state of California to cause cancer. For more information go to www.P65Warnings.ca.gov.



- A
- B
- C
- D
- E
- F
- G
- H
- I
- J
- K
- L
- M
- N
- O

[Click here for CADs, Product Specifications or to Configure Parts Online](#)

- A
- B
- C
- D
- E
- F
- G
- H
- I
- J
- K
- L
- M
- N
- O

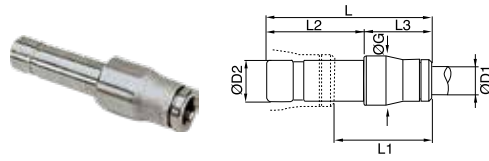

67PLS Tube Reducer - Metric

| PART NO. | TUBE 1 SIZE MM | TUBE 2 SIZE MM | G MM | L MM | L1 MM | L2 MM | L3 MM |
|---------------|----------------|----------------|------|------|-------|-------|-------|
| 67PLS-4M-6M | 4 | 6 | 10 | 35 | 19.0 | 19 | 16 |
| 67PLS-4M-8M | 4 | 8 | 10 | 34 | 17.0 | 20 | 14 |
| 67PLS-6M-8M | 6 | 8 | 12 | 42 | 24.0 | 23 | 19 |
| 67PLS-6M-10M | 6 | 10 | 12 | 42 | 19.0 | 25 | 17 |
| 67PLS-8M-10M | 8 | 10 | 15 | 45 | 22.5 | 25 | 19 |
| 67PLS-8M-12M | 8 | 12 | 15 | 43 | 20.0 | 26 | 17 |
| 67PLS-10M-12M | 10 | 12 | 17 | 51 | 23.0 | 26 | 25 |

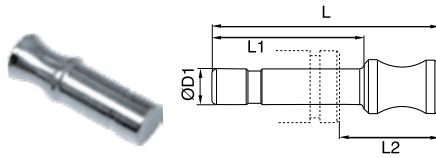

639PLS Plug - Metric

| PART NO. | TUBE 1 SIZE MM | L MM | L1 MM | L2 MM |
|------------|----------------|-------|-------|-------|
| 639PLS-4M | 4 | 25.40 | 17.00 | 11.10 |
| 639PLS-6M | 6 | 30.40 | 19.50 | 13.50 |
| 639PLS-8M | 8 | 33.00 | 20.00 | 14.40 |
| 639PLS-10M | 10 | 40.00 | 25.00 | 17.00 |
| 639PLS-12M | 12 | 43.00 | 26.00 | 18.70 |

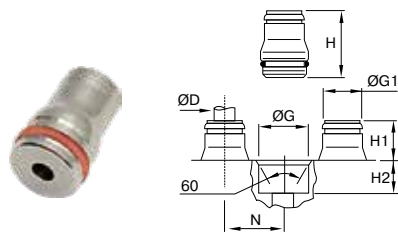

PLSC Cartridge - Metric

| PART NO. | TUBE SIZE MM | G +.1 - 0 MM | G1 MM | H MM | H1 MM | H2 MM | N MM |
|----------|--------------|--------------|-------|-------|-------|-------|-------|
| PLSC-4M | 4 | 9.80 | 8 | 18.00 | 9.50 | 8.50 | 11.00 |
| PLSC-6M | 6 | 12.10 | 10 | 20.00 | 11.50 | 8.50 | 13.50 |
| PLSC-8M | 8 | 14.80 | 13 | 22.00 | 13.50 | 8.50 | 16.00 |
| PLSC-10M | 10 | 17.50 | 15 | 25.50 | 15.00 | 10.50 | 20.00 |

WARNING These products can expose you to chemicals including NICKEL, which is known to the state of California to cause cancer. For more information go to www.P65Warnings.ca.gov.



Pneumatic: Integrated Fittings

Compact Flow Controls

Miniature Flow Controls

Swivel Outlet Flow Controls

Plug-In Flow Controls

In-Line Flow Controls

Metal Flow Controls

Brass Flow Controls

Stainless Steel Flow Controls

In-Line Check Valves

Stainless Steel Check Valves

Piloted Operated Check Valves

Pneumatic Slide Valves

Quick Exhaust Valve

Blocking Valves

Manually Operated Valves

Threshold Sensor Fittings

Mini Ball Valves



■ Compact Flow Controls

FCC731
Meter Out
BSPT, BSPP
p. B8



FCCI731
Meter In
BSPT, BSPP
p. B8



FCCB731
Bi-Directional
BSPT, BSPP
p. B9



FCKC731
Meter Out
Knobless BSPP
p. B9



FCKCI731
Meter In Knobless
BSPP
p. B10



FCKCB731
Bi-Directional
Knobless BSPP
p. B10



FCCS731
Meter Out
p. B15



FCMS731
Meter Out Miniature
BSPP
p. B15



FCMSI731
Meter In Miniature
BSPP
p. B16



FCCS731
Meter Out
BSPP
p. B16



■ Miniature Flow Controls

FCM731
Meter Out
BSPT, BSPP
p. B12



FCMI731
Meter In
BSPT, BSPP
p. B12, B13



FCMB731
Bi-Directional
BSPP
p. B13



FCMK731
Meter Out
Knobless
p. B13



■ Plug-In Flow Controls

FCMSP731
Meter Out
Miniature
p. B18



FCMSPI731
Meter In
Miniature
p. B18



FCMSPI731
Meter In
Miniature
p. B18



FCCSP731
Meter Out
Compact
p. B18



FCCSPI731
Meter In
Compact
p. B18



■ In-Line Flow Controls

FC832
In-Line
p. B20



FCB832
Bi-Directional
p. B20



FCPM832
Panel Mountable
p. B21



FC836
Threaded In-Line
BSPP
p. B21



■ Metal Flow Controls

FC701
Meter Out
BSPP
p. B23



FCI701
Meter In
BSPP
p. B23



FCK701C
Knobless
Compression
Metal BSPP
p. B23



FC702
Meter Out
BSPP
p. B23



FCI702
Meter In
BSPP
p. B23



FC705
Meter Out
p. B23



FC708
Meter Out
p. B23



⚠ WARNING These products can expose you to chemicals including NICKEL or LEAD, which are known to the state of California to cause cancer, and LEAD which is known to cause birth defects or other reproductive harm. For more information go to www.P65Warnings.ca.gov.

■ **Brass Flow Controls**

FC703

Threaded Port
Meter Out Metal
Flow Control – NPT
p. B24



FC703

Threaded Port
Meter Out Metal
Flow Control – BSPP
p. B24



FC703

Push-To-Connect
Meter Out Metal
Flow Control – NPT
p. B25



■ **Stainless Steel Flow Controls**

7810, 7815

Meter Out
NPT
p. B27



7812, 7817

Bi-Directional NPT
p. B27



7810

Meter Out
BSPP
p. B27



7812

Bi-Directional
BSPP
p. B27



7835

Meter Out NPT
p. B27



■ **Check Valves**

32PLCK

In-Line
p. B29



W68PLCK

Meter Out
BSPT
p. B29



W68PLCKI

Meter In
BSPT
p. B29



68PLCK

Meter Out
BSPP
p. B30



68PLCKI

Meter In
BSPP
p. B30



VC

Check Valve
p. B30



■ **Stainless Steel Check Valves**

4890

Unidirectional
BSPP
p. B32



4891

Male x Female
BSPP
p. B32



4892

Female x Male
BSPP
p. B32



4895

Unidirectional
NPT
p. B32



■ **Pilot Operated Check Valves**

7892

BSPP
p. B34



7894

Regulator &
Exhaust BSPP
p. B34



■ **Pneumatic Slide Valves**

0660

Female NPT
p. B36



0661

Male x Female
NPT
p. B36



0669

Female BSPP
p. B36



WARNING These products can expose you to chemicals including NICKEL or LEAD, which are known to the state of California to cause cancer, and LEAD which is known to cause birth defects or other reproductive harm. For more information go to www.P65Warnings.ca.gov.

A

B

C

D

E

F

G

H

I

J

K

L

M

N

O

A
B
C
D
E
F
G
H
I
J
K
L
M
N
O

■ **Manually Operated 3-Way Venting Valves**

7805/7806
p. B41



7800/7801
p. B41



■ **Quick Exhaust**

7970
BSPP
p. B37



7982
NPT
p. B37



■ **Blocking Valves**

FC601
Lock Out
BSPT, BSPP
p. B39



FC602
Lock Out
p. B39



FC608
Lock Out
BSPT, BSPP
p. B39



■ **Threshold Sensor**

PSBJ731
Pneumatic
5/32 Pilot
p. B43



PSBJ731
Pneumatic
4mm Pilot
p. B43



PSPJ731
Pneumatic
10-32 Pilot
p. B43



PSBJ708
Pneumatic
M5 Pilot
p. B43



PSPE731
Pneumatic /
Electric
BSPP
p. B43



■ **Mini Ball Valve**

MV308
Male BSPP
p. B45



MV309
Push-to-Connect
Ports, Vented
p. B45



MVV308
Male BSPP,
Vented
p. B45



MVV309
Push-to-
Connect Ports
p. B45



WARNING These products can expose you to chemicals including NICKEL or LEAD, which are known to the state of California to cause cancer, and LEAD which is known to cause birth defects or other reproductive harm. For more information go to www.P65Warnings.ca.gov.

A

B

C

D

E

F

G

H

I

J

K

L

M

N

O



Compact Flow Controls

Parker's compact flow controls ensure excellent performance of flow and are perfectly suited for reduced spaces due to their small size.

Product Features:

- Glass reinforced nylon 6.6 body
- Stainless steel gripping ring
- Nickel-plated brass adjustment screw
- Nickel-plated brass locking nut
- Nickel-plated brass threads
- Nitrile D seal
- NPT
- BSPT
- BSPP
- Metric threads

Markets:

- Factory/Process Automation
- Life Science
- Food Processing
- Water And Beverage
- Petrochemical

Applications:

- Packaging
- Filling
- Dispensing
- Bottling
- Pneumatic Circuits

Specifications:

Pressure Range 15 to 145 psi (1.0 to 9.9 bar)

Temperature Range +32° to +158° F (0 to +70° C)

Compatible Tubing:

- Semi-rigid nylon
- Polyurethane 95 Durometer Shore A
- Nylon
- Fluoropolymer

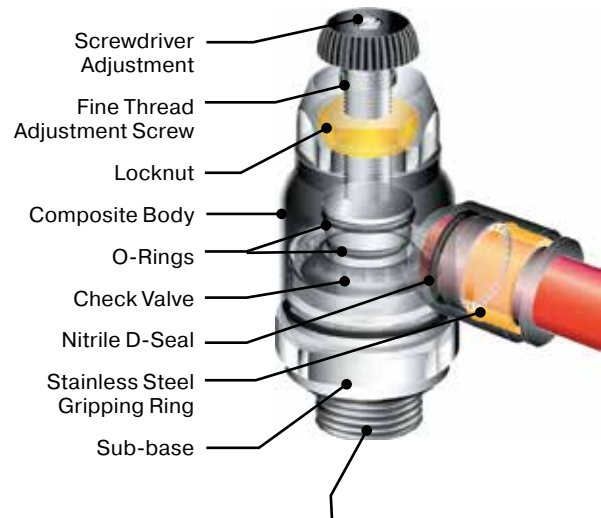

Sealing O-ring on BSPP
Thread Sealant on NPT/BSPT

Assembly Instructions

1. Cut tubing squarely – maximum of 15° angle allowable.
2. Check that port or mating part is clean and free of debris.
3. Mark tubing to appropriate tube insertion length. (see Tube Insertion Chart on page N22)
4. Insert tubing until it bottoms
5. Pull on tubing to verify it is fully inserted
6. To disassemble, simply press release button, hold against body and pull tubing out of fitting.



WARNING These products can expose you to chemicals including NICKEL or LEAD, which are known to the state of California to cause cancer, and LEAD which is known to cause birth defects or other reproductive harm. For more information go to www.P65Warnings.ca.gov.



Click here for CADs, Product Specifications or to Configure Parts Online

- A
- B
- C
- D
- E
- F
- G
- H
- I
- J
- K
- L
- M
- N
- O

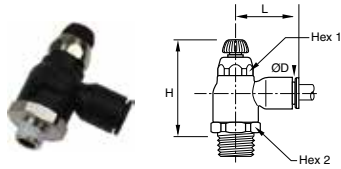

FCC731 Compact Meter Out

| PART NO. | TUBE SIZE IN | NPT | HEX 1 | HEX 2 | H OPEN | H CLOSED | L |
|-------------|--------------|-----|-------|-------|--------|----------|------|
| FCC731-4M-2 | 5/32(4MM) | 1/8 | .63 | .39 | 1.67 | 1.44 | .85 |
| FCC731-4M-4 | 5/32(4MM) | 1/4 | .63 | .39 | 1.67 | 1.44 | .85 |
| FCC731-4-2 | 1/4 | 1/8 | .63 | .39 | 1.67 | 1.44 | .85 |
| FCC731-4-4 | 1/4 | 1/4 | .63 | .39 | 1.67 | 1.44 | .85 |
| FCC731-6-4 | 3/8 | 1/4 | .91 | .67 | 2.03 | 1.71 | 1.22 |
| FCC731-6-6 | 3/8 | 3/8 | .91 | .67 | 2.03 | 1.71 | 1.22 |
| FCC731-6-8 | 3/8 | 1/2 | .67 | .91 | 2.03 | 1.71 | 1.22 |
| FCC731-8-8 | 1/2 | 1/2 | .67 | .91 | 2.03 | 1.71 | 1.22 |

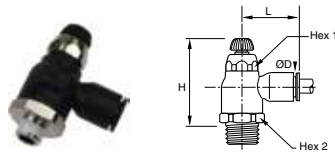

FCC731 Compact Meter Out - BSPT

| PART NO. | TUBE SIZE MM | BSPT | HEX 1 | HEX 2 | H CLOSED | H OPEN | L |
|---------------|--------------|------|-------|-------|----------|--------|------|
| FCC731-6M-2R | 6 | 1/8 | 16 | 10 | 36.5 | 42.5 | 22.0 |
| FCC731-8M-2R | 8 | 1/8 | 19 | 14 | 40.0 | 45.0 | 27.0 |
| FCC731-8M-4R | 8 | 1/4 | 19 | 14 | 40.0 | 45.0 | 27.0 |
| FCC731-10M-4R | 10 | 1/4 | 23 | 17 | 43.5 | 51.5 | 31.5 |
| FCC731-10M-6R | 10 | 3/8 | 23 | 17 | 43.5 | 51.5 | 31.5 |
| FCC731-10M-8R | 10 | 1/2 | 23 | 17 | 43.5 | 51.5 | 31.5 |
| FCC731-12M-4R | 12 | 1/4 | 23 | 17 | 43.5 | 51.5 | 35.0 |
| FCC731-12M-6R | 12 | 3/8 | 23 | 17 | 43.5 | 51.5 | 35.0 |
| FCC731-12M-8R | 12 | 1/2 | 23 | 17 | 43.5 | 51.5 | 35.0 |

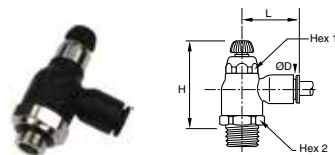

FCC731 Compact Meter Out - BSPP

| PART NO. | TUBE SIZE MM | BSPP | HEX 1 | HEX 2 | H CLOSED | H OPEN | L |
|---------------|--------------|------|-------|-------|----------|--------|------|
| FCC731-4M-2G | 4 | 1/8 | 10 | 16 | 38.0 | 44.0 | 22.0 |
| FCC731-6M-2G | 6 | 1/8 | 10 | 16 | 38.0 | 44.0 | 22.0 |
| FCC731-6M-4G | 6 | 1/4 | 10 | 16 | 36.5 | 42.5 | 22.0 |
| FCC731-8M-2G | 8 | 1/8 | 14 | 19 | 41.5 | 48.0 | 28.0 |
| FCC731-8M-4G | 8 | 1/4 | 14 | 19 | 41.5 | 48.0 | 28.0 |
| FCC731-8M-6G | 8 | 3/8 | 14 | 19 | 41.5 | 48.0 | 28.0 |
| FCC731-10M-4G | 10 | 1/4 | 17 | 23 | 45.5 | 53.5 | 31.5 |
| FCC731-10M-6G | 10 | 3/8 | 17 | 23 | 45.5 | 54.0 | 31.5 |
| FCC731-12M-6G | 12 | 3/8 | 17 | 23 | 45.5 | 54.0 | 35.0 |
| FCC731-12M-8G | 12 | 1/2 | 17 | 24 | 45.5 | 54.0 | 35.0 |

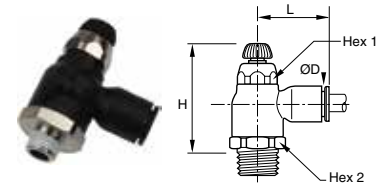

FCCI731 Compact Meter In Flow Control

| PART NO. | TUBE SIZE IN | NPT | HEX 1 | HEX 2 | H OPEN | H CLOSED | L |
|--------------|--------------|-----|-------|-------|--------|----------|-----|
| FCCI731-4M-2 | 5/32(4MM) | 1/8 | .63 | .39 | 1.67 | 1.44 | .85 |
| FCCI731-4M-4 | 5/32(4MM) | 1/4 | .63 | .39 | 1.67 | 1.44 | .85 |
| FCCI731-4-2 | 1/4 | 1/8 | .63 | .39 | 1.67 | 1.44 | .85 |
| FCCI731-4-4 | 1/4 | 1/4 | .63 | .39 | 1.67 | 1.44 | .85 |

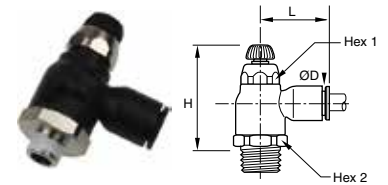

FCCI731 Compact Meter In Flow Control - BSPT

| PART NO. | TUBE SIZE MM | BSPT | HEX 1 | HEX 2 | H CLOSED | H OPEN | L |
|----------------|--------------|------|-------|-------|----------|--------|------|
| FCCI731-10M-4R | 10 | 1/4 | 23 | 17 | 43.5 | 51.5 | 31.5 |
| FCCI731-10M-8R | 10 | 1/2 | 23 | 17 | 43.5 | 51.5 | 31.5 |

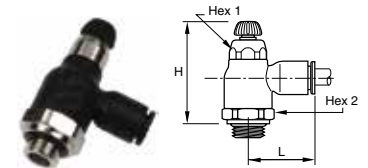

FCCI731 Compact Meter In Flow Control - BSPP

| PART NO. | TUBE SIZE MM | BSPP | HEX 1 | HEX 2 | H CLOSED | H OPEN | L |
|----------------|--------------|------|-------|-------|----------|--------|------|
| FCCI731-4M-2G | 4 | 1/8 | 10 | 16 | 38.0 | 44.0 | 22.0 |
| FCCI731-6M-2G | 6 | 1/8 | 10 | 16 | 38.0 | 44.0 | 22.0 |
| FCCI731-6M-4G | 6 | 1/4 | 10 | 16 | 36.5 | 42.5 | 22.0 |
| FCCI731-8M-2G | 8 | 1/8 | 14 | 19 | 41.5 | 48.0 | 28.0 |
| FCCI731-8M-4G | 8 | 1/4 | 14 | 19 | 41.5 | 48.0 | 28.0 |
| FCCI731-8M-6G | 8 | 3/8 | 14 | 19 | 41.5 | 48.0 | 28.0 |
| FCCI731-10M-4G | 10 | 1/4 | 17 | 23 | 45.5 | 53.5 | 31.5 |
| FCCI731-10M-6G | 10 | 3/8 | 17 | 23 | 45.5 | 54.0 | 31.5 |
| FCCI731-12M-8G | 12 | 1/2 | 17 | 24 | 45.5 | 54.0 | 35.0 |

WARNING These products can expose you to chemicals including NICKEL or LEAD, which are known to the state of California to cause cancer, and LEAD which is known to cause birth defects or other reproductive harm. For more information go to www.P65Warnings.ca.gov.

Click here for CADs, Product Specifications or to Configure Parts Online

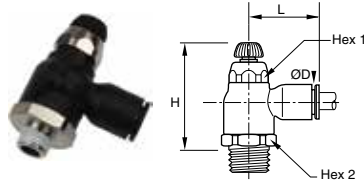

FCCB731 Compact Bi-Directional Flow Control

| PART NO. | TUBE SIZE IN | NPT | HEX 1 | HEX 2 | H OPEN | H CLOSED | L |
|--------------|--------------|-----|-------|-------|--------|----------|-----|
| FCCB731-4M-2 | 5/32(4MM) | 1/8 | .63 | .39 | 1.67 | 1.44 | .85 |
| FCCB731-4-2 | 1/4 | 1/8 | .63 | .39 | 1.67 | 1.44 | .85 |
| FCCB731-4-4 | 1/4 | 1/4 | .63 | .39 | 1.67 | 1.44 | .85 |

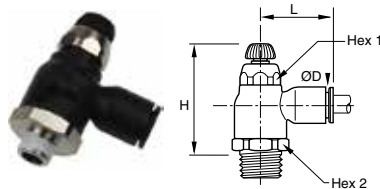

FCCB731 Compact Bi-Directional Flow Control - BSPT

| PART NO. | TUBE SIZE MM | BSPT | HEX 1 | HEX 2 | H CLOSED | H OPEN | L |
|---------------|--------------|------|-------|-------|----------|--------|------|
| FCCB731-4M-2R | 4 | 1/8 | 16 | 10 | 36.5 | 42.5 | 22.0 |
| FCCB731-6M-2R | 6 | 1/8 | 16 | 10 | 36.5 | 42.5 | 22.0 |
| FCCB731-6M-4R | 6 | 1/4 | 16 | 10 | 36.5 | 42.5 | 22.0 |
| FCCB731-8M-2R | 8 | 1/8 | 19 | 14 | 40.0 | 45.0 | 27.0 |
| FCCB731-8M-4R | 8 | 1/4 | 19 | 14 | 40.0 | 45.0 | 27.0 |
| FCCB731-8M-6R | 8 | 3/8 | 19 | 14 | 40.0 | 45.0 | 27.0 |

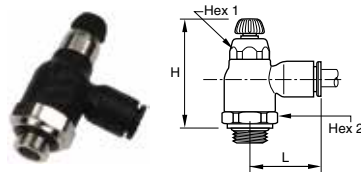

FCCB731 Compact Bi-Directional Flow Control - BSPP

| PART NO. | TUBE SIZE MM | BSPP | HEX 1 | HEX 2 | H CLOSED | H OPEN | L |
|---------------|--------------|------|-------|-------|----------|--------|------|
| FCCB731-4M-2G | 4 | 1/8 | 10 | 16 | 38.0 | 44.0 | 22.0 |
| FCCB731-6M-2G | 6 | 1/8 | 10 | 16 | 38.0 | 44.0 | 22.0 |
| FCCB731-6M-4G | 6 | 1/4 | 10 | 16 | 36.5 | 42.5 | 22.0 |
| FCCB731-8M-2G | 8 | 1/8 | 14 | 19 | 41.5 | 48.0 | 28.0 |
| FCCB731-8M-4G | 8 | 1/4 | 14 | 19 | 41.5 | 48.0 | 28.0 |
| FCCB731-8M-6G | 8 | 3/8 | 14 | 19 | 41.5 | 48.0 | 28.0 |

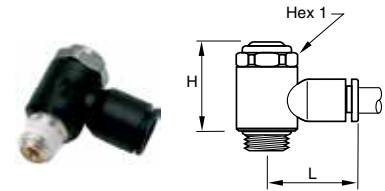

FCKC731 Knobless Meter Out Flow Control

| ART NO. | TUBE SIZE IN | NPT / UNF | HEX 1 MM | H | L |
|--------------|--------------|-----------|----------|------|------|
| FCKC731-2-0 | 1/8 | 10-32 | | .69 | .65 |
| FCKC731-2-2 | 1/8 | 1/8 | 13 | .79 | .75 |
| FCKC731-4M-0 | 5/32(4MM) | 10-32 | | .69 | .65 |
| FCKC731-4M-2 | 5/32(4MM) | 1/8 | 13 | .79 | .75 |
| FCKC731-4-0 | 1/4 | 10-32 | | .69 | .77 |
| FCKC731-4-2 | 1/4 | 1/8 | 13 | .79 | .85 |
| FCKC731-4-4 | 1/4 | 1/4 | 17 | 1.04 | .89 |
| FCKC731-8M-2 | 5/16(8MM) | 1/8 | 13 | .79 | 1.02 |
| FCKC731-8M-4 | 5/16(8MM) | 1/4 | 17 | 1.04 | 1.06 |
| FCKC731-6-4 | 3/8 | 1/4 | 17 | 1.04 | 1.14 |
| FCKC731-6-6 | 3/8 | 3/8 | 20 | 1.14 | 1.36 |

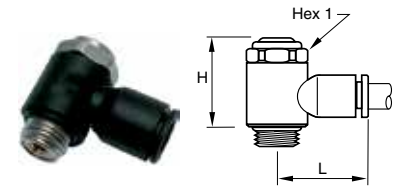

FCKC731 Knobless Compact Flow Control - BSPP

| PART NO. | TUBE SIZE MM | BSPP / M5 | HEX 1 | H | L |
|----------------|--------------|-----------|-------|------|------|
| FCKC731-4M-M5 | 4 | M5X0.8 | 8.0 | 17.5 | 17.0 |
| FCKC731-4M-2G | 4 | 1/8 | 13.0 | 25.0 | 19.0 |
| FCKC731-6M-M5 | 6 | M5X0.8 | 8.0 | 17.5 | 19.0 |
| FCKC731-6M-2G | 6 | 1/8 | 13.0 | 25.0 | 21.0 |
| FCKC731-6M-4G | 6 | 1/4 | 17.0 | 26.5 | 22.0 |
| FCKC731-8M-2G | 8 | 1/8 | 13.0 | 25.0 | 26.0 |
| FCKC731-8M-4G | 8 | 1/4 | 17.0 | 26.5 | 27.0 |
| FCKC731-8M-6G | 8 | 3/8 | 20.0 | 37.5 | 29.0 |
| FCKC731-10M-4G | 10 | 1/4 | 17.0 | 26.5 | 29.0 |
| FCKC731-10M-6G | 10 | 3/8 | 20.0 | 37.5 | 31.0 |
| FCKC731-10M-8G | 10 | 1/2 | 23.0 | 43.0 | 37.0 |
| FCKC731-12M-6G | 12 | 3/8 | 20.0 | 37.5 | 6.8 |
| FCKC731-12M-8G | 12 | 1/2 | 23.0 | 43.0 | 37.0 |

WARNING These products can expose you to chemicals including NICKEL or LEAD, which are known to the state of California to cause cancer, and LEAD which is known to cause birth defects or other reproductive harm. For more information go to www.P65Warnings.ca.gov.



- A
- B
- C
- D
- E
- F
- G
- H
- I
- J
- K
- L
- M
- N
- O

Click here for CADs, Product Specifications or to Configure Parts Online

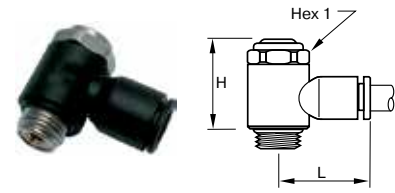
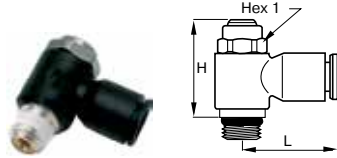

FCKCI731 Knobless Meter In Flow Control

| PART NO. | TUBE SIZE IN | NPT / UNF | HEX 1 MM | H | L |
|---------------|--------------|-----------|----------|-----|-----|
| FCKCI731-4M-2 | 5/32(4MM) | 1/8 | 13 | .79 | .75 |
| FCKCI731-4-2 | 1/4 | 1/8 | 13 | .79 | .85 |

FCKCB731 Knobless Bi-directional Flow Control - BSPP

| PART NO. | TUBE SIZE MM | BSPP / M5 | HEX 1 | H | L |
|----------------|--------------|-----------|-------|------|------|
| FCKCB731-4M-M5 | 4 | M5X0.8 | 8 | 17.5 | 17.0 |
| FCKCB731-4M-2G | 4 | 1/8 | 13 | 25.0 | 19.0 |
| FCKCB731-6M-M5 | 6 | M5X0.8 | 8 | 17.5 | 19.0 |
| FCKCB731-6M-2G | 6 | 1/8 | 13 | 25.0 | 21.0 |
| FCKCB731-6M-4G | 6 | 1/4 | 17 | 26.5 | 22.0 |
| FCKCB731-8M-2G | 8 | 1/8 | 13 | 25.0 | 26.0 |
| FCKCB731-8M-4G | 8 | 1/4 | 17 | 26.5 | 27.0 |
| FCKCB731-8M-6G | 8 | 3/8 | 20 | 37.5 | 29.0 |

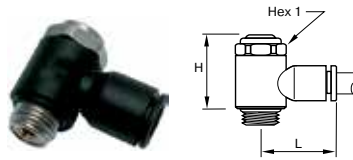

FCKCI731 Knobless Compact Meter In Flow Control-BSPP

| PART NO. | TUBE SIZE MM | BSPP / M5 | HEX 1 | H | L |
|-----------------|--------------|-----------|-------|------|------|
| FCKCI731-4M-M5 | 4 | M5X0.8 | 8.0 | 17.5 | 17.0 |
| FCKCI731-4M-2G | 4 | 1/8 | 13.0 | 25.0 | 19.0 |
| FCKCI731-6M-M5 | 6 | M5X0.8 | 8.0 | 17.5 | 19.0 |
| FCKCI731-6M-2G | 6 | 1/8 | 13.0 | 25.0 | 21.0 |
| FCKCI731-6M-4G | 6 | 1/4 | 17.0 | 26.5 | 22.0 |
| FCKCI731-8M-2G | 8 | 1/8 | 13.0 | 25.0 | 26.0 |
| FCKCI731-8M-4G | 8 | 1/4 | 17.0 | 26.5 | 27.0 |
| FCKCI731-8M-6G | 8 | 3/8 | 20.0 | 37.5 | 29.0 |
| FCKCI731-10M-4G | 10 | 1/4 | 17.0 | 26.5 | 29.0 |
| FCKCI731-10M-6G | 10 | 3/8 | 20.0 | 37.5 | 31.0 |

WARNING These products can expose you to chemicals including NICKEL or LEAD, which are known to the state of California to cause cancer, and LEAD which is known to cause birth defects or other reproductive harm. For more information go to www.P65Warnings.ca.gov.



A

B

C

D

E

F

G

H

I

J

K

L

M

N

O

Miniature Flow Controls



Parker's miniature flow controls ensure excellent performance of flow and are perfectly suited for reduced spaces due to their small size.

Product Features:

- Glass reinforced nylon 6.6 body
- Stainless steel gripping ring
- Nickel-plated brass adjustment screw
- Nickel-plated brass locking nut
- Nickel-plated brass threads
- Nitrile D seal
- NPT, BSPT, BSPP, Metric threads

Markets:

- Factory/Process Automation
- Life Science
- Food Processing
- Water And Beverage
- Petrochemical

Applications:

- Packaging
- Filling
- Dispensing
- Bottling
- Pneumatic Circuits

Specifications:

Pressure Range 15 to 145 psi (1.0 to 9.9 bar)

Temperature Range +32° to +158° F (0 to +70° C)

Compatible Tubing:

- Semi-rigid nylon
- Polyurethane 95 Durometer Shore A
- Nylon
- Fluoropolymer

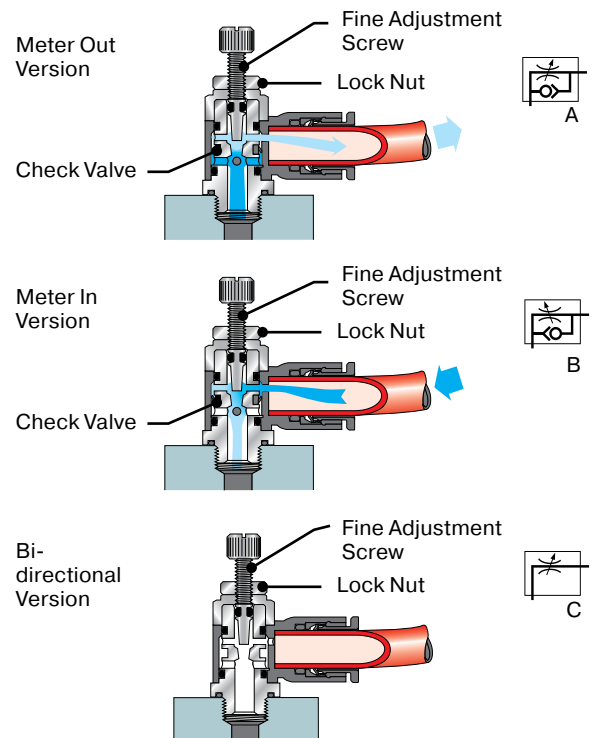

Assembly Instructions

1. Cut tubing squarely – maximum of 15° angle allowable.
2. Check that port or mating part is clean and free of debris.
3. Mark tubing to appropriate tube insertion length. (see Tube Insertion Chart on page N22)
4. Insert tubing until it bottoms
5. Pull on tubing to verify it is fully inserted
6. To disassemble, simply press release button, hold against body and pull tubing out of fitting.

WARNING These products can expose you to chemicals including NICKEL or LEAD, which are known to the state of California to cause cancer, and LEAD which is known to cause birth defects or other reproductive harm. For more information go to www.P65Warnings.ca.gov.



Click here for CADs, Product Specifications or to Configure Parts Online

- A
- B
- C
- D
- E
- F
- G
- H
- I
- J
- K
- L
- M
- N
- O

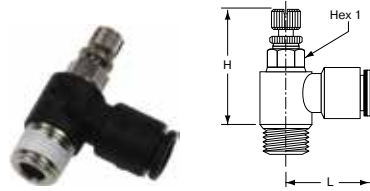

FCM731 Miniature Meter Out Flow Control

| PART NO. | TUBE SIZE IN | NPT | HEX 1 MM | H OPEN | H CLOSED | L |
|---------------|--------------|-------|----------|--------|----------|-----|
| FCM731-2-0 | 1/8 | 10-32 | 6 | 1.14 | .91 | .67 |
| FCM731-2-2 | 1/8 | 1/8 | 7 | 1.41 | 1.26 | .69 |
| FCM731-5/32-0 | 5/32 | 10-32 | 6 | 1.02 | .93 | .67 |
| FCM731-5/32-2 | 5/32 | 1/8 | 7 | 1.16 | 1.06 | .71 |
| FCM731-4-0 | 1/4 | 10-32 | 6 | 1.02 | .93 | .73 |
| FCM731-4-2 | 1/4 | 1/8 | 7 | 1.16 | 1.06 | .75 |
| FCM731-4-4 | 1/4 | 1/4 | 8 | 1.28 | 1.18 | .77 |

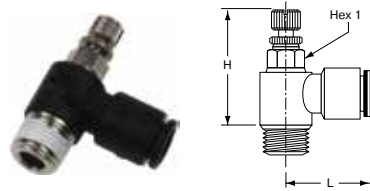

FCMI731 Miniature Meter In Flow Control

| PART NO. | TUBE SIZE IN | NPT | HEX 1 MM | H OPEN | H CLOSED | L |
|----------------|--------------|-------|----------|--------|----------|-----|
| FCMI731-2-0 | 1/8 | 10-32 | 6 | 1.14 | .91 | .67 |
| FCMI731-5/32-0 | 5/32 | 10-32 | 6 | 1.02 | .93 | .67 |
| FCMI731-5/32-2 | 5/32 | 1/8 | 7 | 1.16 | 1.06 | .71 |
| FCMI731-4-0 | 1/4 | 10-32 | 6 | 1.02 | .93 | .73 |
| FCMI731-4-2 | 1/4 | 1/8 | 7 | 1.16 | 1.06 | .75 |
| FCMI731-4-4 | 1/4 | 1/4 | 8 | 1.28 | 1.18 | .77 |

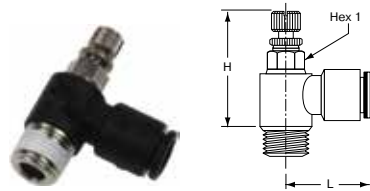

FCM731 Miniature Meter Out Flow Control - BSPT

| PART NO. | TUBE SIZE MM | BSPT | HEX 1 | H CLOSED | H OPEN | L |
|--------------|--------------|------|-------|----------|--------|------|
| FCM731-4M-2R | 4 | 1/8 | 7 | 25.0 | 27.5 | 18.0 |
| FCM731-6M-2R | 6 | 1/8 | 7 | 25.0 | 27.5 | 18.5 |
| FCM731-6M-4R | 6 | 1/4 | 8 | 27.5 | 30.0 | 19.0 |
| FCM731-6M-6R | 6 | 3/8 | 17 | 31.5 | 34.0 | 19.0 |
| FCM731-8M-2R | 8 | 1/8 | 13 | 28.5 | 33.0 | 26.0 |
| FCM731-8M-4R | 8 | 1/4 | 16 | 31.0 | 35.0 | 27.5 |
| FCM731-8M-6R | 8 | 3/8 | 20 | 36.0 | 42.0 | 29.0 |



FCMI731 Miniature Meter In Flow Control - BSPT

| PART NO. | TUBE SIZE MM | BSPT | HEX 1 | H CLOSED | H OPEN | L |
|---------------|--------------|------|-------|----------|--------|------|
| FCMI731-4M-2R | 4 | 1/8 | 7 | 25.0 | 27.5 | 18.0 |
| FCMI731-6M-2R | 6 | 1/8 | 7 | 25.0 | 27.5 | 18.5 |
| FCMI731-6M-4R | 6 | 1/4 | 8 | 27.5 | 30.0 | 19.0 |
| FCMI731-8M-2R | 8 | 1/8 | 13 | 28.5 | 33.0 | 26.0 |
| FCMI731-8M-4R | 8 | 1/4 | 16 | 31.0 | 35.0 | 27.5 |

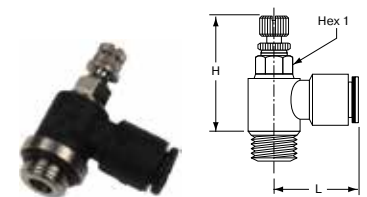

FCM731 Miniature Meter Out Flow Control - BSPP

| PART NO. | TUBE SIZE MM | BSPP | HEX 1 | H CLOSED | H OPEN | L |
|--------------|--------------|--------|-------|----------|--------|------|
| FCM731-3M-M3 | 3 | M3X0.5 | 6 | 23.5 | 26.0 | 17.0 |
| FCM731-3M-M5 | 3 | M5X0.8 | 6 | 23.5 | 26.0 | 17.0 |
| FCM731-4M-M3 | 4 | M3X0.5 | 6 | 23.5 | 26.0 | 16.5 |
| FCM731-4M-M5 | 4 | M5X0.8 | 6 | 23.5 | 26.0 | 17.0 |
| FCM731-4M-2G | 4 | 1/8 | 7 | 27.0 | 29.5 | 18.0 |
| FCM731-6M-M5 | 6 | M5X0.8 | 6 | 23.5 | 26.0 | 18.0 |
| FCM731-6M-2G | 6 | 1/8 | 7 | 27.0 | 29.5 | 18.5 |
| FCM731-6M-4G | 6 | 1/4 | 8 | 30.0 | 32.5 | 19.0 |
| FCM731-8M-2G | 8 | 1/8 | 13 | 26.5 | 31.0 | 26.0 |
| FCM731-8M-4G | 8 | 1/4 | 16 | 29.0 | 34.0 | 27.5 |
| FCM731-8M-6G | 8 | 3/8 | 20 | 36.0 | 42.0 | 29.0 |

WARNING These products can expose you to chemicals including NICKEL or LEAD, which are known to the state of California to cause cancer, and LEAD which is known to cause birth defects or other reproductive harm. For more information go to www.P65Warnings.ca.gov.

[Click here for CADs, Product Specifications or to Configure Parts Online](#)

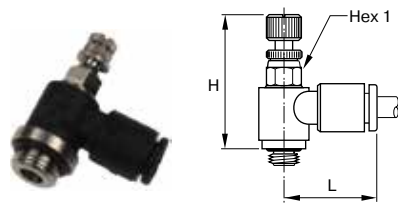

FCMI731 Miniature Meter In Flow Control - BSPP

| PART NO. | TUBE SIZE MM | BSPP | HEX 1 | H CLOSED | H OPEN | L |
|---------------|--------------|--------|-------|----------|--------|------|
| FCMI731-3M-M3 | 3 | M3X0.5 | 6 | 23.5 | 26.0 | 17.0 |
| FCMI731-3M-M5 | 3 | M5X0.8 | 6 | 23.5 | 26.0 | 17.0 |
| FCMI731-4M-M5 | 4 | M5X0.8 | 6 | 23.5 | 26.0 | 17.0 |
| FCMI731-4M-2G | 4 | 1/8 | 7 | 27.0 | 29.5 | 18.0 |
| FCMI731-6M-M5 | 6 | M5X0.8 | 6 | 23.5 | 26.0 | 18.0 |
| FCMI731-6M-2G | 6 | 1/8 | 7 | 27.0 | 29.5 | 18.5 |
| FCMI731-6M-4G | 6 | 1/4 | 8 | 30.0 | 32.5 | 19.0 |
| FCMI731-8M-2G | 8 | 1/8 | 13 | 26.5 | 31.0 | 26.0 |
| FCMI731-8M-4G | 8 | 1/4 | 16 | 29.0 | 34.0 | 27.5 |
| FCMI731-8M-6G | 8 | 3/8 | 20 | 36.0 | 42.0 | 29.0 |

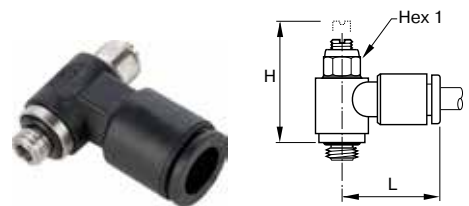

FCMK731 Knobless Mini Meter Out Flow Control

| PART NO. | TUBE SIZE IN | NPT | HEX 1 MM | H OPEN | H CLOSED | L |
|----------------|--------------|-------|----------|--------|----------|-----|
| FCMK731-2-0 | 1/8 | 10-32 | 6 | .79 | .65 | .65 |
| FCMK731-2-2 | 1/8 | 1/8 | 6 | .85 | .71 | .71 |
| FCMK731-5/32-0 | 5/32 | 10-32 | 6 | .79 | .65 | .65 |
| FCMK731-5/32-2 | 5/32 | 1/8 | 6 | .85 | .71 | .71 |
| FCMK731-4-0 | 1/4 | 10-32 | 6 | .79 | .65 | .65 |
| FCMK731-4-2 | 1/4 | 1/8 | 6 | .85 | .71 | .73 |
| FCMK731-4-4 | 1/4 | 1/4 | 6 | .97 | .83 | .73 |

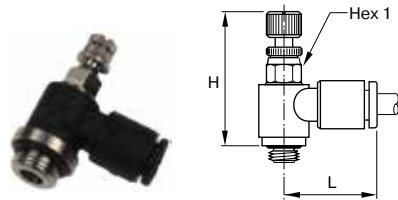

FCMB731 Miniature Bi-directional Flow Control - BSPP

| PART NO. | TUBE SIZE MM | BSPP | HEX 1 | H CLOSED | H OPEN | L |
|---------------|--------------|--------|-------|----------|--------|------|
| FCMB731-4M-M5 | 4 | M5X0.8 | 6 | 23.5 | 26.0 | 16.5 |
| FCMB731-4M-2G | 4 | 1/8 | 7 | 27.0 | 29.5 | 17.0 |
| FCMB731-6M-M5 | 6 | M5X0.8 | 6 | 23.5 | 26.0 | 18.0 |
| FCMB731-6M-2G | 6 | 1/8 | 7 | 27.0 | 29.5 | 18.0 |
| FCMB731-6M-4G | 6 | 1/4 | 8 | 30.0 | 32.5 | 18.5 |

WARNING These products can expose you to chemicals including NICKEL or LEAD, which are known to the state of California to cause cancer, and LEAD which is known to cause birth defects or other reproductive harm. For more information go to www.P65Warnings.ca.gov.



- A
- B
- C
- D
- E
- F
- G
- H
- I
- J
- K
- L
- M
- N
- O

A

B

C

D

E

F

G

H

I

J

K

L

M

N

O



Swivel Outlet Flow Controls

Parker's swivel outlet flow controls are designed to allow a vertical or angled tube exit where access is restricted.

Product Features:

- Glass reinforced nylon 6.6 body
- Stainless steel gripping ring
- Nickel-plated brass adjustment screw
- Nickel-plated brass locking nut
- Nickel-plated brass threads
- Nitrile D seal
- NPT, BSPT, BSPP, Metric threads

Markets:

- Factory/Process Automation
- Life Science
- Food Processing
- Water And Beverage
- Petrochemical

Applications:

- Packaging
- Filling
- Dispensing
- Bottling
- Pneumatic Circuits

Specifications:

Pressure Range 15 to 145 psi (1.0 to 9.9 bar)

Temperature Range +32° to +158° F (0 to +70° C)

Compatible Tubing:

- Semi-rigid nylon
- Polyurethane 95 Durometer Shore A
- Nylon
- Fluoropolymer

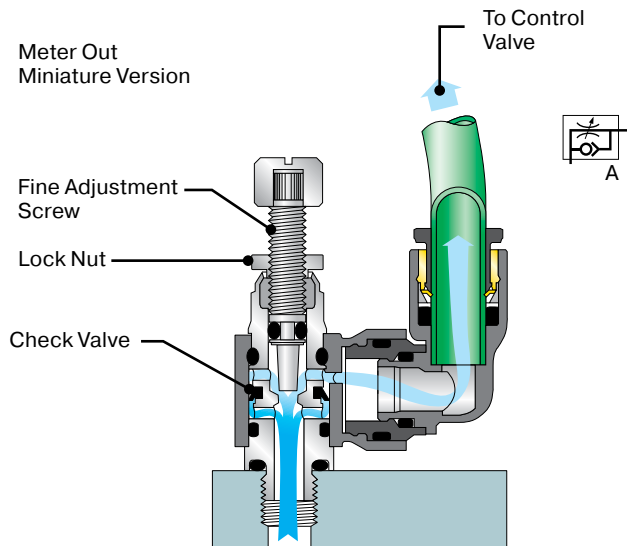

Assembly Instructions

1. Cut tubing squarely – maximum of 15° angle allowable.
2. Check that port or mating part is clean and free of debris.
3. Mark tubing to appropriate tube insertion length. (see Tube Insertion Chart on page N22)
4. Insert tubing until it bottoms
5. Pull on tubing to verify it is fully inserted
6. To disassemble, simply press release button, hold against body and pull tubing out of fitting.

WARNING These products can expose you to chemicals including NICKEL or LEAD, which are known to the state of California to cause cancer, and LEAD which is known to cause birth defects or other reproductive harm. For more information go to www.P65Warnings.ca.gov.



[Click here for CADs, Product Specifications or to Configure Parts Online](#)

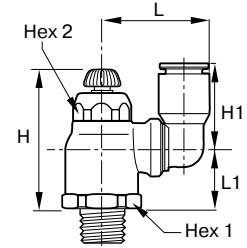

FCCS731 Compact Swivel Outlet Meter Out Flow Control

| PART NO. | TUBE SIZE IN | NPT | HEX 1 MM | HEX 2 MM | H CLOSED | H OPEN | H1 | L | L1 |
|-------------|--------------|-----|----------|----------|----------|--------|------|------|-----|
| FCCS731-4-2 | 1/4 | 1/8 | 19 | 10 | 1.87 | 2.09 | .63 | .93 | .65 |
| FCCS731-4-4 | 1/4 | 1/4 | 19 | 14 | 1.79 | 1.99 | .73 | 1.00 | .89 |
| FCCS731-6-4 | 3/8 | 1/4 | 23 | 17 | 1.93 | 2.20 | 1.04 | 1.34 | .97 |
| FCCS731-6-6 | 3/8 | 3/8 | 23 | 17 | 1.93 | 2.20 | 1.04 | 1.34 | .97 |

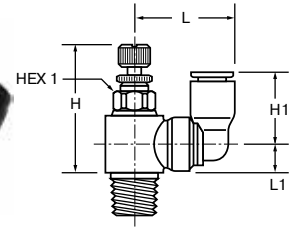

FCMS731 Mini Swivel Outlet Meter Out Flow Control

| PART NO. | TUBE SIZE IN | NPT | HEX 1 MM | H CLOSED | H OPEN | H1 | L | L1 |
|--------------|--------------|-------|----------|----------|--------|-----|------|------|
| FCMS731-4M-0 | 5/32 (4MM) | 10-32 | 6 | .96 | 1.08 | .55 | 0.73 | 0.26 |
| FCMS731-4M-2 | 5/32 (4MM) | 1/8 | 8 | 1.08 | 1.20 | .55 | 0.73 | 0.33 |

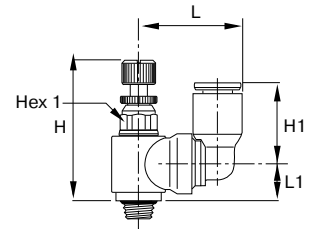

FCMS731 Miniature Swivel Outlet Meter Out - BSPP

| PART NO. | TUBE SIZE MM | BSPP | HEX 1 | H CLOSED | H OPEN | H1 | L | L1 |
|---------------|--------------|--------|-------|----------|--------|------|------|-----|
| FCMS731-4M-M5 | 4 | M5X0.8 | 6 | 24.5 | 27.5 | 14.5 | 19.5 | 6.5 |
| FCMS731-4M-2G | 4 | 1/8 | 7 | 27.5 | 31.0 | 14.5 | 20.0 | 8.5 |
| FCMS731-6M-M5 | 6 | M5X0.8 | 6 | 24.5 | 27.5 | 16.0 | 21.5 | 6.5 |
| FCMS731-6M-2G | 6 | 1/8 | 7 | 27.5 | 31.0 | 16.0 | 22.0 | 8.5 |

WARNING These products can expose you to chemicals including NICKEL or LEAD, which are known to the state of California to cause cancer, and LEAD which is known to cause birth defects or other reproductive harm. For more information go to www.P65Warnings.ca.gov.



- A
- B
- C
- D
- E
- F
- G
- H
- I
- J
- K
- L
- M
- N
- O

[Click here for CADs, Product Specifications or to Configure Parts Online](#)

A

B

C

D

E

F

G

H

I

J

K

L

M

N

O

FCMSI731 Miniature Swivel Outlet Meter In - BSPP

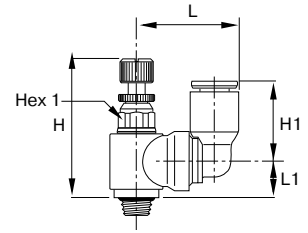

| PART NO. | TUBE SIZE MM | BSPP | HEX 1 | H CLOSED | H OPEN | H1 | L | L1 |
|----------------|--------------|--------|-------|----------|--------|------|------|-----|
| FCMSI731-4M-M5 | 4 | M5X0.8 | 6 | 24.5 | 27.5 | 14.5 | 19.5 | 6.5 |
| FCMSI731-6M-M5 | 6 | M5X0.8 | 6 | 24.5 | 27.5 | 16.0 | 21.5 | 6.5 |
| FCMSI731-6M-2G | 6 | 1/8 | 7 | 27.5 | 31.0 | 16.0 | 22.0 | 8.5 |

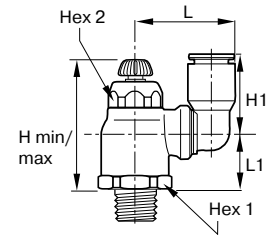

FCCS731 Compact Swivel Outlet - BSPP

| PART NO. | TUBE SIZE MM | BSPP | HEX 1 | HEX 2 | H CLOSED | H OPEN | H1 | L | L1 |
|----------------|--------------|------|-------|-------|----------|--------|------|------|------|
| FCCS731-6M-2G | 6 | 1/8 | 16 | 10 | 38.0 | 44.0 | 16.0 | 23.5 | 18.0 |
| FCCS731-6M-4G | 6 | 1/4 | 16 | 10 | 36.5 | 42.5 | 16.0 | 23.5 | 16.5 |
| FCCS731-8M-2G | 8 | 1/8 | 19 | 14 | 41.5 | 48.0 | 23.0 | 28.0 | 19.0 |
| FCCS731-8M-4G | 8 | 1/4 | 19 | 14 | 41.5 | 48.0 | 23.0 | 28.0 | 19.5 |
| FCCS731-8M-6G | 8 | 3/8 | 19 | 14 | 41.5 | 48.0 | 23.0 | 28.0 | 17.5 |
| FCCS731-10M-4G | 10 | 1/4 | 23 | 17 | 45.5 | 53.5 | 26.5 | 35.0 | 21.0 |
| FCCS731-10M-6G | 10 | 3/8 | 23 | 17 | 45.5 | 54.0 | 26.5 | 35.0 | 21.5 |
| FCCS731-12M-6G | 12 | 3/8 | 23 | 17 | 45.5 | 54.0 | 31.0 | 38.0 | 21.5 |
| FCCS731-12M-8G | 12 | 1/2 | 23 | 17 | 45.5 | 54.0 | 31.0 | 38.0 | 21.0 |

WARNING These products can expose you to chemicals including NICKEL or LEAD, which are known to the state of California to cause cancer, and LEAD which is known to cause birth defects or other reproductive harm. For more information go to www.P65Warnings.ca.gov.





Plug-In Flow Controls

Parker's Plug-in flow controls can be directly mounted into existing fittings and allow very compact installations. They are particularly suited for mounting in manifolds using cartridges.

Product Features:

- Glass reinforced nylon 6.6 body
- Stainless steel gripping ring
- Nickel-plated brass adjustment screw
- Nickel-plated brass locking nut
- Nickel-plated tailpiece
- Nitrile D seal

Markets:

- Factory/Process Automation
- Life Science
- Food Processing
- Water And Beverage
- Petrochemical

Applications:

- Packaging
- Filling
- Dispensing
- Bottling
- Pneumatic Circuits

Specifications:

Pressure Range 15 to 145 psi (1.0 to 9.9 bar)

Temperature Range +32° to +158° F (0 to +70° C)

Compatible Tubing:

- Semi-rigid nylon
- Polyurethane 95 Durometer Shore A
- Nylon
- Fluoropolymer

Miniature

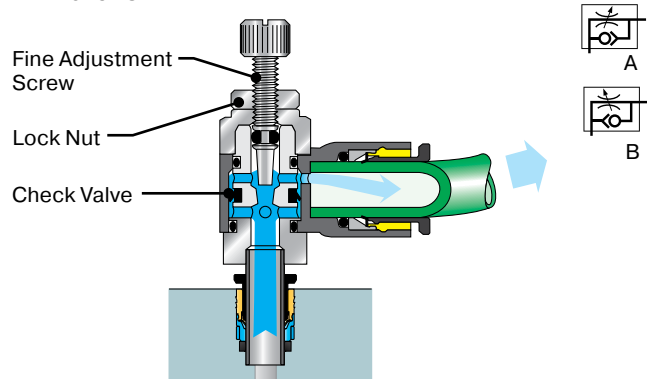

Compact

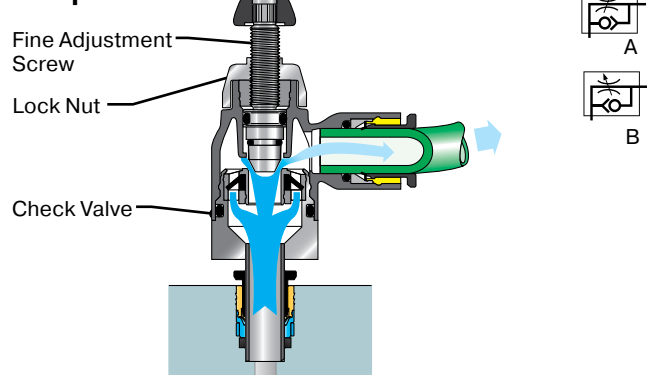

Assembly Instructions

1. Cut tubing squarely – maximum of 15° angle allowable.
2. Check that port or mating part is clean and free of debris.
3. Mark tubing to appropriate tube insertion length. (see Tube Insertion Chart on page N22)
4. Insert tubing until it bottoms
5. Pull on tubing to verify it is fully inserted
6. To disassemble, simply press release button, hold against body and pull tubing out of fitting.

WARNING These products can expose you to chemicals including NICKEL or LEAD, which are known to the state of California to cause cancer, and LEAD which is known to cause birth defects or other reproductive harm. For more information go to www.P65Warnings.ca.gov.

Click here for CADs, Product Specifications or to Configure Parts Online

A

B

C

D

E

F

G

H

I

J

K

L

M

N

O

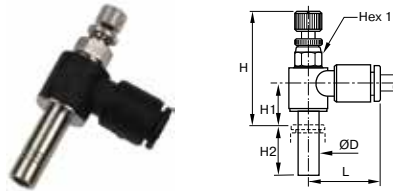

FCMSPI731 Plug-In Mini Meter Out Flow Control

| PART NO. | TUBE SIZE IN | HEX 1 MM | H OPEN | H CLOSED | H1 | H2 | L |
|-------------|--------------|----------|--------|----------|-----|-----|------|
| FCMSPI731-2 | 1/8 | 6 | 1.04 | .94 | .12 | .59 | 0.67 |
| FCMSPI731-4 | 1/4 | 7 | 1.18 | 1.08 | .12 | .73 | 0.73 |

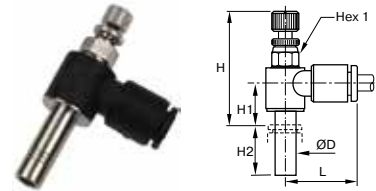

FCMSPI731 Plug-In Mini Meter In Flow Control

| PART NO. | TUBE SIZE MM | HEX 1 | H CLOSED | H OPEN | H1 | H2 | L |
|---------------------|--------------|-------|----------|--------|------|------|------|
| FCMSPI731-4M (5/32) | 4 | 6 | 25.5 | 28.0 | 9.5 | 15.5 | 17.0 |
| FCMSPI731-6M | 6 | 7 | 27.5 | 29.0 | 10.5 | 17.0 | 18.5 |

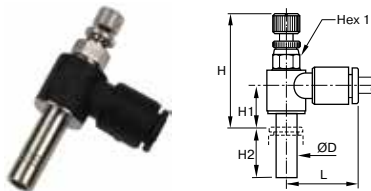

FCMSPI731 Plug-In Mini Meter In Flow Control

| PART NO. | TUBE SIZE IN | HEX 1 MM | H OPEN | H CLOSED | H1 | H2 | L |
|-------------|--------------|----------|--------|----------|-----|------|------|
| FCMSPI731-2 | 1/8 | 6 | 1.04 | .94 | .12 | 0.59 | 0.67 |
| FCMSPI731-4 | 1/4 | 7 | 1.18 | 1.08 | .12 | 0.73 | 0.73 |

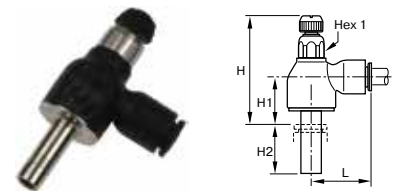

FCCSP731 Plug-In Compact Meter Out Flow Control

| PART NO. | TUBE SIZE MM | HEX 1 | H CLOSED | H OPEN | H1 | H2 | L |
|--------------|--------------|-------|----------|--------|------|------|------|
| FCCSP731-6M | 6 | 10 | 35.0 | 41.0 | 14.0 | 17.0 | 22.0 |
| FCCSP731-8M | 8 | 14 | 39.5 | 46.5 | 16.0 | 21.5 | 28.0 |
| FCCSP731-12M | 12 | 17 | 43.0 | 51.0 | 17.0 | 27.0 | 31.5 |

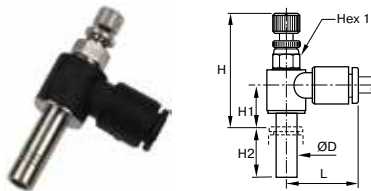

FCMSPI731 - Plug-In Miniature Meter Out Flow Control

| PART NO. | TUBE SIZE MM | HEX 1 | H CLOSED | H OPEN | H1 | H2 | L |
|---------------------|--------------|-------|----------|--------|------|------|------|
| FCMSPI731-4M (5/32) | 4 | 6 | 25.5 | 28.0 | 9.5 | 15.5 | 17.0 |
| FCMSPI731-6M | 6 | 7 | 27.5 | 29.0 | 10.5 | 17.0 | 18.5 |

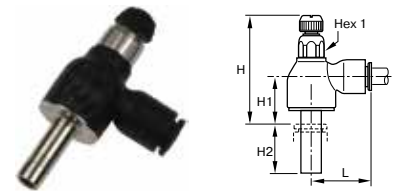

FCCSPI731 Plug-In Compact Meter-In Flow Control

| PART NO. | TUBE SIZE MM | HEX 1 | H CLOSED | H OPEN | H1 | H2 | L |
|---------------|--------------|-------|----------|--------|------|------|------|
| FCCSPI731-6M | 6 | 10 | 35.0 | 41.0 | 14.0 | 17.0 | 22.0 |
| FCCSPI731-8M | 8 | 14 | 39.5 | 46.5 | 16.0 | 21.5 | 28.0 |
| FCCSPI731-12M | 12 | 17 | 43.0 | 51.0 | 17.0 | 27.0 | 31.5 |

WARNING These products can expose you to chemicals including NICKEL or LEAD, which are known to the state of California to cause cancer, and LEAD which is known to cause birth defects or other reproductive harm. For more information go to www.P65Warnings.ca.gov.



A

B

C

D

E

F

G

H

I

J

K

L

M

N

O

In-Line Flow Controls



Parker's In-Line flow controls are unidirectional. An arrow on the body indicates the direction of controlled flow. They can be used individually or stacked together using joining clips.

Product Features:

- Glass reinforced nylon 6.6 body
- Stainless steel gripping ring
- Nickel-plated brass adjustment screw
- Nickel-plated brass locking nut
- Nickel-plated threads
- Nitrile D seal
- Panel mountable

Markets:

- Factory/Process Automation
- Life Science
- Food Processing
- Water And Beverage
- Petrochemical

Applications:

- Packaging
- Filling
- Dispensing
- Bottling
- Pneumatic Circuits

Specifications:

Pressure Range 15 to 145 psi (1.0 to 9.9 bar)

Temperature Range +32° to +158° F (0 to +70° C)

Compatible Tubing:

- Semi-rigid nylon
- Polyurethane 95 Durometer Shore A
- Nylon
- Fluoropolymer

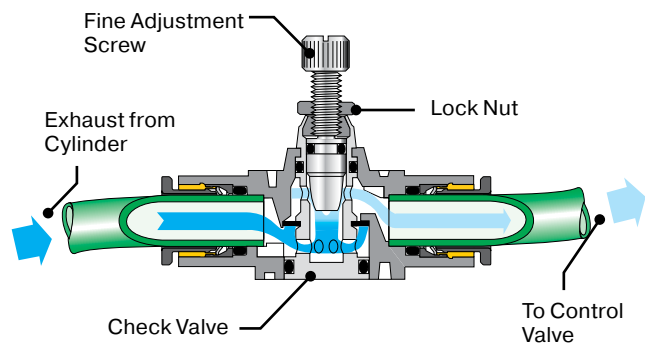

Assembly Instructions

1. Cut tubing squarely – maximum of 15° angle allowable.
2. Check that port or mating part is clean and free of debris.
3. Mark tubing to appropriate tube insertion length. (see Tube Insertion Chart on page N22)
4. Insert tubing until it bottoms
5. Pull on tubing to verify it is fully inserted
6. To disassemble, simply press release button, hold against body and pull tubing out of fitting.

WARNING These products can expose you to chemicals including NICKEL or LEAD, which are known to the state of California to cause cancer, and LEAD which is known to cause birth defects or other reproductive harm. For more information go to www.P65Warnings.ca.gov.



[Click here for CADs, Product Specifications or to Configure Parts Online](#)

A

B

C

D

E

F

G

H

I

J

K

L

M

N

O

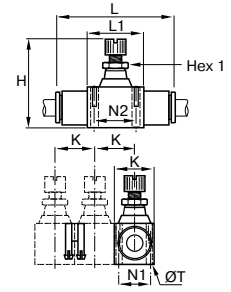

FC832 In-Line Flow Control

| PART NO. | TUBE SIZE IN | HEX 1 MM | H CLOSED | H OPEN | K | L | L1 | N1 | N2 | T |
|----------|--------------|----------|----------|--------|------|------|------|-----|------|------|
| FC832-4 | 1/4 | 8 | 1.54 | 1.74 | .66 | 2.00 | .90 | .43 | .66 | .12 |
| FC832-6 | 3/8 | 14 | 2.03 | 2.38 | .94 | 2.87 | 1.29 | .62 | 1.01 | 1.60 |
| FC832-8 | 1/2 | 14 | 2.24 | 2.63 | 1.09 | 3.35 | 1.37 | .78 | 1.07 | .16 |

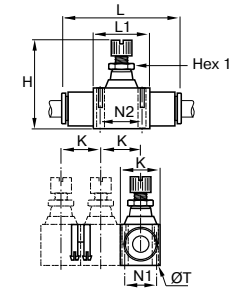

FCB832 In-Line Bi-directional Flow Control

| PART NO. | TUBE SIZE IN | HEX 1 MM | H CLOSED | H OPEN | K | L | L1 | N1 | N2 | T |
|----------|--------------|----------|----------|--------|-----|------|-----|-----|-----|-----|
| FCB832-4 | 1/4 | 8 | 1.54 | 1.74 | .66 | 2.00 | .90 | .43 | .66 | .12 |

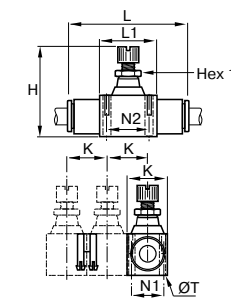

FC832 In-Line Flow Control

| PART NO. | TUBE SIZE MM | HEX 1 | H CLOSED | H OPEN | K | L | L1 | N1 | N2 | T |
|-----------------|--------------|-------|----------|--------|------|------|------|------|------|-----|
| FC832-4M | 4 | 5 | 29.5 | 33.5 | 12 | 15 | 12 | 8 | 11 | 2.2 |
| FC832-6M | 6 | 8 | 40.5 | 44.5 | 17.0 | 51.0 | 23.0 | 11.0 | 17.0 | 3.2 |
| FC832-8M (5/16) | 8 | 11 | 44.0 | 50.0 | 18.5 | 60.5 | 26.0 | 12.5 | 20.0 | 3.2 |
| FC832-10M | 10 | 14 | 52.0 | 61.0 | 24.0 | 76.0 | 33.0 | 16.0 | 26.0 | 4.2 |
| FC832-12M | 12 | 14 | 57.5 | 67.5 | 28.0 | 86.0 | 35.0 | 20.0 | 27.5 | 4.2 |

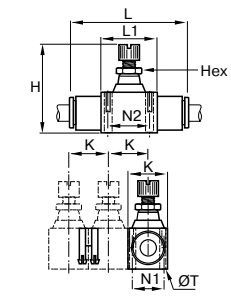

FCB832 In-Line Bi-directional Flow Control

| PART NO. | TUBE SIZE MM | HEX 1 | H CLOSED | H OPEN | K | L | L1 | N1 | N2 | T |
|------------------|--------------|-------|----------|--------|------|------|------|------|------|-----|
| FCB832-4M (5/32) | 4 | 5 | 29.5 | 33.5 | 12.0 | 36.0 | 15.0 | 8.0 | 11.0 | 2.2 |
| FCB832-6M | 6 | 8 | 40.0 | 44.5 | 17.0 | 51.0 | 23.0 | 11.0 | 17.0 | 3.2 |
| FCB832-8M (5/16) | 8 | 11 | 44.0 | 50.0 | 18.5 | 60.5 | 26.0 | 12.5 | 20.0 | 3.2 |

WARNING These products can expose you to chemicals including NICKEL or LEAD, which are known to the state of California to cause cancer, and LEAD which is known to cause birth defects or other reproductive harm. For more information go to www.P65Warnings.ca.gov.



Click here for CADs, Product Specifications or to Configure Parts Online

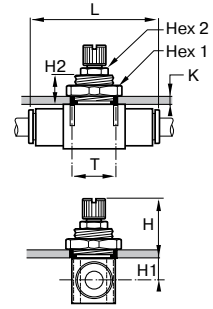

FCPM832 In-Line Panel Mountable Flow Control

| PART NO. | TUBE SIZE MM | HEX 1 | HEX 2 | H CLOSED | H OPEN | K | L | H1 | H2 | T |
|-------------|--------------|-------|-------|----------|--------|-----|------|------|------|------|
| FCPM832-4M | 4 | 14 | | 21.5 | 25.5 | 6.0 | 36.0 | 6.5 | 11.0 | 10.5 |
| FCPM832-6M | 6 | 19 | | 27.5 | 32.5 | 7.0 | 51.0 | 7.5 | 13.5 | 16.5 |
| FCPM832-8M | 8 | 24 | 11 | 28.5 | 34.5 | 7.0 | 60.5 | 9.0 | 13.5 | 18.5 |
| FCPM832-10M | 10 | 30 | 14 | 29.5 | 38.5 | 7.0 | 76.0 | 11.5 | 13.5 | 24.5 |
| FCPM832-12M | 12 | 32 | 14 | 32.0 | 42.0 | 8.0 | 86.0 | 12.5 | 15.5 | 27.5 |

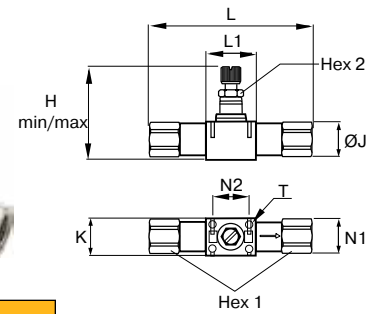

FC836 Threaded In-Line Flow Control

| PART NO. | NPT | HEX 1 MM | HEX 2 MM | H CLOSED | H OPEN | K | L | L1 | N1 | N2 | T |
|----------|-----|----------|----------|----------|--------|------|------|------|-----|------|-----|
| FC836-2 | 1/8 | 13 | 8.00 | 1.56 | 1.75 | .67 | 2.70 | .91 | .43 | .67 | .12 |
| FC836-4 | 1/4 | 16 | 11.00 | 1.73 | 1.97 | .73 | 3.27 | 1.02 | .49 | .79 | .12 |
| FC836-6 | 3/8 | 22 | 14.00 | 2.05 | 2.40 | .94 | 3.82 | 1.30 | .63 | 1.02 | .16 |
| FC836-8 | 1/2 | 24 | 14.00 | 2.26 | 2.66 | 1.10 | 4.76 | 1.38 | .79 | 1.08 | .16 |

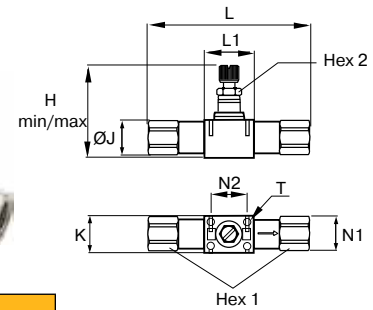

FC836 Threaded In-Line Flow Control - BSPP

| PART NO. | BSPP | HEX 1 | HEX 2 | H CLOSED | H OPEN | K | L | N1 | N2 | T |
|----------|------|-------|-------|----------|--------|------|-------|------|------|-----|
| FC836-2G | 1/8 | 13 | 8 | 39.5 | 44.5 | 17.0 | 68.5 | 11.0 | 17.0 | 3.2 |
| FC836-4G | 1/4 | 16 | 11 | 44.0 | 50.0 | 18.5 | 83.0 | 12.5 | 20.0 | 3.2 |
| FC836-6G | 3/8 | 19 | 14 | 52.0 | 61.0 | 24.0 | 97.0 | 16.0 | 26.0 | 4.2 |
| FC836-8G | 1/2 | 24 | 14 | 57.5 | 67.5 | 28.0 | 121.0 | 20.0 | 27.5 | 4.2 |

WARNING These products can expose you to chemicals including NICKEL or LEAD, which are known to the state of California to cause cancer, and LEAD which is known to cause birth defects or other reproductive harm. For more information go to www.P65Warnings.ca.gov.



- A
- B
- C
- D
- E
- F
- G
- H
- I
- J
- K
- L
- M
- N
- O

A

B

C

D

E

F

G

H

I

J

K

L

M

N

O



Metal Flow Controls

Parker's Metal flow controls are suited for use in severe conditions (temperatures, sparks, abrasion, etc.). Adjustment can be made with a screwdriver and locking by use of a wrench.

Product Features:

- Treated brass body
- Stainless steel gripping ring
- Electroless-nickel-plated brass adjustment screw
- Nickel-plated brass locking nut
- Nickel-plated threads
- Nitrile D seal

Markets:

- Factory/Process Automation
- Petrochemical
- Automotive Process

Applications:

- Robotics
- Packaging
- Textile

Specifications:

Pressure Range 15 to 145 psi (1.0 to 9.9 bar)

Temperature Range -4° to +158° F (-20° to +70° C)

Note: Temperature rating is based upon filtered, dry compressed air.

Compatible Tubing:

- Semi-rigid nylon
- Polyurethane 95 Durometer Shore A
- Nylon
- Fluoropolymer

Meter Out Version

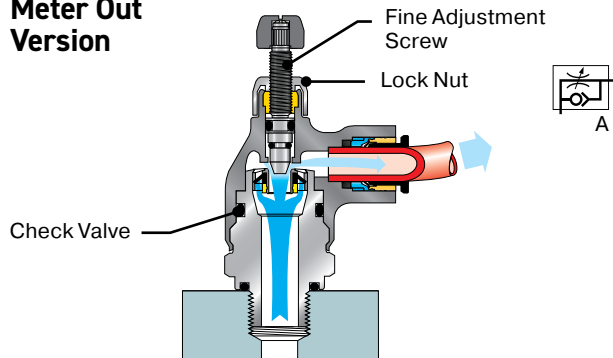

Meter In Version

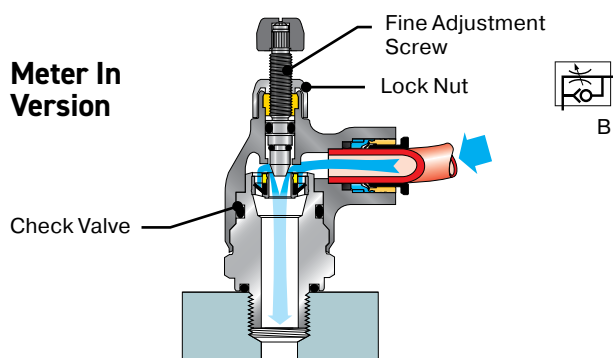

Assembly Instructions

1. Cut tubing squarely – maximum of 15° angle allowable.
2. Check that port or mating part is clean and free of debris.
3. Mark tubing to appropriate tube insertion length. (see Tube Insertion Chart on page N22)
4. Insert tubing until it bottoms
5. Pull on tubing to verify it is fully inserted
6. To disassemble, simply press release button, hold against body and pull tubing out of fitting.

WARNING These products can expose you to chemicals including NICKEL or LEAD, which are known to the state of California to cause cancer, and LEAD which is known to cause birth defects or other reproductive harm. For more information go to www.P65Warnings.ca.gov.



Click here for CADs, Product Specifications or to Configure Parts Online

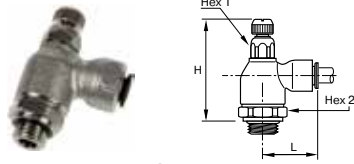

FC701 Push-to-Connect Meter In Metal Flow Control - BSPP

| PART NO. | TUBE SIZE MM | BSPP | HEX 1 | HEX 2 | H CLOSED | H OPEN | L |
|--------------|--------------|------|-------|-------|----------|--------|------|
| FC701-4M-2G | 4 | 1/8 | 10 | 19 | 47.0 | 53.0 | 21.0 |
| FC701-6M-2G | 6 | 1/8 | 10 | 19 | 47.0 | 53.0 | 24.5 |
| FC701-6M-4G | 6 | 1/4 | 10 | 19 | 47.5 | 53.0 | 24.5 |
| FC701-8M-2G | 8 | 1/8 | 14 | 19 | 50.0 | 55.0 | 29.0 |
| FC701-8M-4G | 8 | 1/4 | 14 | 19 | 50.0 | 56.0 | 29.0 |
| FC701-8M-6G | 8 | 3/8 | 17 | 25 | 56.0 | 62.0 | 30.5 |
| FC701-10M-4G | 10 | 1/4 | 14 | 19 | 50.0 | 56.0 | 35.0 |
| FC701-10M-6G | 10 | 3/8 | 17 | 25 | 56.0 | 62.0 | 35.0 |
| FC701-12M-6G | 12 | 3/8 | 17 | 25 | 56.0 | 62.0 | 38.0 |
| FC701-12M-8G | 12 | 1/2 | 17 | 25 | 55.0 | 62.0 | 38.0 |
| FC701-14M-8G | 14 | 1/2 | 17 | 25 | 55.0 | 62.0 | 41.0 |

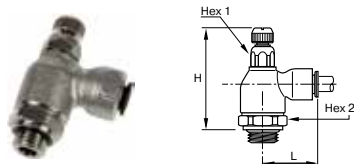

FCI701 Push-to-Connect Meter In Metal Flow Control - BSPP

| PART NO. | TUBE SIZE MM | BSPP | HEX 1 | HEX 2 | H CLOSED | H OPEN | L |
|--------------|--------------|------|-------|-------|----------|--------|------|
| FCI701-4M-2G | 4 | 1/8 | 10 | 19 | 47.0 | 53.0 | 21.0 |
| FCI701-6M-2G | 6 | 1/8 | 10 | 19 | 47.0 | 53.0 | 24.5 |
| FCI701-6M-4G | 6 | 1/4 | 10 | 19 | 47.5 | 53.0 | 24.5 |
| FCI701-8M-2G | 8 | 1/8 | 14 | 19 | 50.0 | 55.0 | 29.0 |
| FCI701-8M-4G | 8 | 1/4 | 14 | 19 | 50.0 | 56.0 | 29.0 |
| FCI701-8M-6G | 8 | 3/8 | 17 | 25 | 56.0 | 62.0 | 30.5 |

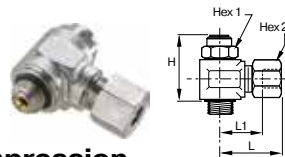

FCK701C Knobless Compression Metal Flow Control - BSPP

| PART NO. | TUBE SIZE MM | BSPP | HEX 1 | HEX 2 | H | L | L1 |
|----------------|--------------|------|-------|-------|------|------|------|
| FCK701C-4M-2G | 4 | 1/8 | 13 | 10 | 26.0 | 25.5 | 14.5 |
| FCK701C-6M-2G | 6 | 1/8 | 13 | 13 | 26.0 | 25.5 | 14.5 |
| FCK701C-6M-4G | 6 | 1/4 | 17 | 13 | 31.5 | 28.5 | 17.5 |
| FCK701C-8M-2G | 8 | 1/8 | 13 | 14 | 26.0 | 29.5 | 15.5 |
| FCK701C-8M-4G | 8 | 1/4 | 17 | 14 | 31.5 | 31.0 | 17.0 |
| FCK701C-10M-4G | 10 | 1/4 | 17 | 19 | 31.5 | 35.0 | 19.0 |
| FCK701C-10M-6G | 10 | 3/8 | 20 | 19 | 44.5 | 37.5 | 19.0 |
| FCK701C-10M-8G | 10 | 1/2 | 23 | 19 | 50.0 | 37.5 | 19.0 |
| FCK701C-12M-8G | 12 | 1/2 | 23 | 22 | 50.0 | 38.0 | 21.5 |

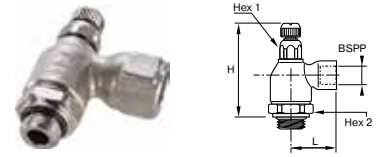

FC702 Threaded Port Meter Out Metal Flow Control - BSPP

| PART NO. | BSPP | HEX 1 | HEX 2 | H CLOSED | H OPEN | L |
|----------|------|-------|-------|----------|--------|------|
| FC702-2G | 1/8 | 10 | 19 | 47.0 | 52.5 | 22.5 |
| FC702-4G | 1/4 | 14 | 19 | 50.5 | 55.5 | 32.0 |
| FC702-6G | 3/8 | 17 | 25 | 56.0 | 62.0 | 34.5 |
| FC702-8G | 1/2 | 17 | 25 | 55.0 | 62.0 | 37.5 |

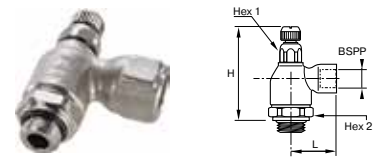

FCI702 Threaded Port Meter In Metal Flow Control - BSPP

| PART NO. | BSPP | HEX 1 | HEX 2 | H CLOSED | H OPEN | L |
|-----------|------|-------|-------|----------|--------|------|
| FCI702-2G | 1/8 | 10 | 19 | 47.0 | 52.5 | 22.5 |
| FCI702-4G | 1/4 | 14 | 19 | 50.5 | 55.5 | 32.0 |

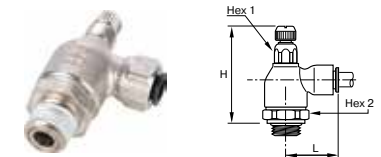

FC705 Push-to-Connect Meter Out Metal Flow Control

| PART NO. | TUBE SIZE IN | NPT | HEX 1 MM | HEX 2 MM | H CLOSED | H OPEN | L |
|-----------|--------------|-----|----------|----------|----------|--------|------|
| FC705-4-2 | 1/4 | 1/8 | 19 | 10 | 1.79 | 2.01 | 0.97 |
| FC705-4-4 | 1/4 | 1/4 | 19 | 10 | 1.79 | 2.01 | 0.97 |
| FC705-6-4 | 3/8 | 1/4 | 19 | 14 | 1.91 | 2.11 | 1.14 |
| FC705-6-6 | 3/8 | 3/8 | 25 | 17 | 2.15 | 2.40 | 1.40 |

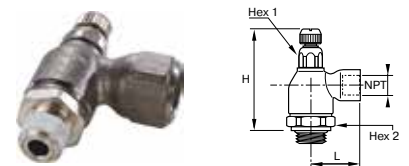

FC708 Threaded Port Meter Out Flow Control

| PART NO. | NPT | HEX 1 MM | HEX 2 MM | H CLOSED | H OPEN | L |
|----------|-----|----------|----------|----------|--------|------|
| FC708-2 | 1/8 | 19 | 10 | 1.79 | 2.01 | .89 |
| FC708-4 | 1/4 | 19 | 14 | 1.91 | 2.11 | 1.28 |
| FC708-6 | 3/8 | 25 | 17 | 2.15 | 2.40 | 1.36 |
| FC708-8 | 1/2 | 25 | 17 | 2.15 | 2.40 | 1.50 |

WARNING These products can expose you to chemicals including NICKEL or LEAD, which are known to the state of California to cause cancer, and LEAD which is known to cause birth defects or other reproductive harm. For more information go to www.P65Warnings.ca.gov.



- A
- B
- C
- D
- E
- F
- G
- H
- I
- J
- K
- L
- M
- N
- O

A

B

Brass Flow Controls

Specifications:

Working Pressure 15 to 150 psi (1.0 to 10.34 bar)

Working Temperature 0° to +200° F (-17.8° to +93.3° C)

Note: Temperature rating is based upon filtered, dry compressed air.

Product Features:

- Controls the speed of a pneumatic actuator
- All brass Construction
- Allen wrench adjusting screw
- NPT and BSPP threads
- Threaded and Push-to-Connect bodies
- UL94 V-0 Flame Resistance Standard
- Silicone Free

Applications: Robotic Welding, End-of-Arm Tooling, Factory Automation, Automotive Assembly, Packaging, etc.

Compatible Tubing: Polyethylene, 95FR, Polyurethane 95 Durometer Shore A, Semi-rigid Nylon, FEP Fluoropolymer

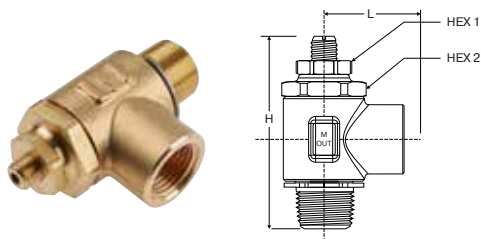
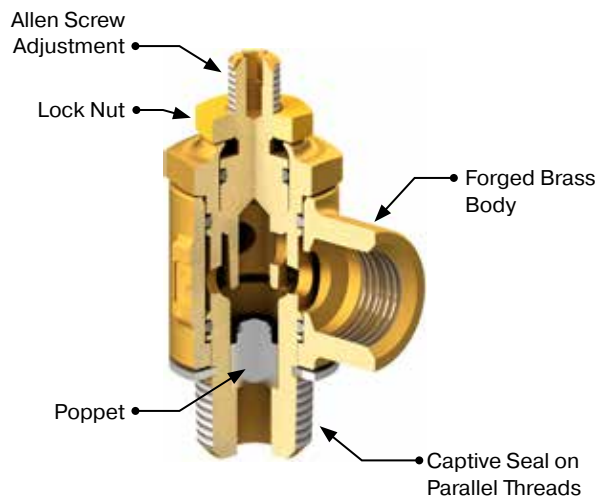

FC703 Threaded Port Meter Out Metal Flow Control – NPT

| PART NO. | NPT | HEX 1 | HEX 2 | H OPEN | H CLOSED | L |
|----------|-----|-------|-------|--------|----------|------|
| FC703-2 | 1/8 | 7/16 | 5/8 | 1.84 | 1.70 | .67 |
| FC703-4 | 1/4 | 5/8 | 15/16 | 2.52 | 2.34 | 1.00 |
| FC703-6 | 3/8 | 5/8 | 15/16 | 2.44 | 2.29 | 1.00 |
| FC703-8 | 1/2 | 13/16 | 1 1/8 | 2.72 | 2.60 | 1.31 |

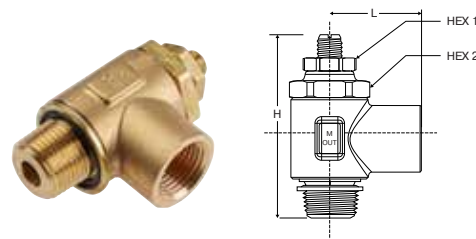

FC703 Threaded Port Meter Out Metal Flow Control – BSPP

| PART NO. | BSPP | HEX 1 | HEX 2 | H OPEN | H CLOSED | L |
|----------|------|-------|-------|--------|----------|------|
| FC703-2G | 1/8 | 7/16 | 5/8 | 1.84 | 1.70 | .78 |
| FC703-4G | 1/4 | 5/8 | 15/16 | 2.52 | 2.34 | 1.05 |
| FC703-6G | 3/8 | 5/8 | 15/16 | 2.44 | 2.29 | 1.20 |
| FC703-8G | 1/2 | 13/16 | 1 1/8 | 2.72 | 2.60 | 1.55 |

WARNING These products can expose you to chemicals including NICKEL or LEAD, which are known to the state of California to cause cancer, and LEAD which is known to cause birth defects or other reproductive harm. For more information go to www.P65Warnings.ca.gov.



[Click here for CADs, Product Specifications or to Configure Parts Online](#)

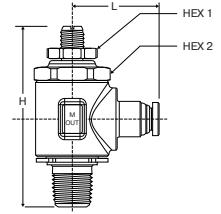
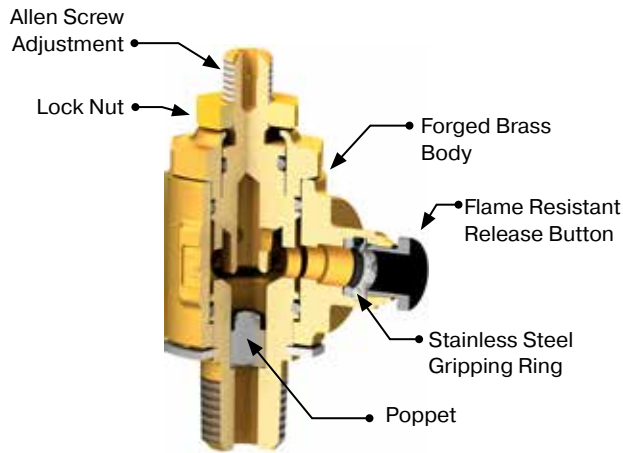

FC703 Push-To-Connect Meter Out Metal Flow Control – NPT

| PART NO. | TUBE SIZE IN | NPT | HEX 1 | HEX 2 | H OPEN | H CLOSED | L |
|-----------|--------------|-----|-------|-------|--------|----------|------|
| FC703-4-2 | 1/4 | 1/8 | 7/16 | 5/8 | 1.84 | 1.70 | 1.21 |
| FC703-4-4 | 1/4 | 1/4 | 5/8 | 15/16 | 2.52 | 2.34 | 1.21 |
| FC703-6-4 | 3/8 | 1/4 | 5/8 | 15/16 | 2.52 | 2.34 | 1.29 |
| FC703-6-6 | 3/8 | 3/8 | 5/8 | 15/16 | 2.44 | 2.29 | 1.29 |

- A
- B
- C
- D
- E
- F
- G
- H
- I
- J
- K
- L
- M
- N
- O

WARNING These products can expose you to chemicals including NICKEL or LEAD, which are known to the state of California to cause cancer, and LEAD which is known to cause birth defects or other reproductive harm. For more information go to www.P65Warnings.ca.gov.



A
B
C
D
E
F
G
H
I
J
K
L
M
N
O

Stainless Steel Flow Controls



Parker's Stainless Steel Flow Controls are used to regulate the speed of a cylinder rod as well as flow in environments with high mechanical or chemical constraints.

Product Features:

- Suitable for corrosive environments
- Excellent mechanical and chemical resistance
- 100% leak tested in production
- Smooth external surfaces to facilitate cleaning
- Suitable for food applications

Markets:

- Factory/Process Automation
- Life Science
- Food Processing
- Water And Beverage
- Petrochemical

Applications:

- Packaging
- Filling
- Dispensing
- Bottling,
- Pneumatic Circuits
- Semi-Conductors

Specifications:

Pressure Range 15 to 145 psi (1.0 to 9.9 bar)

Temperature Range +32° to +158° F (0 to +70° C)

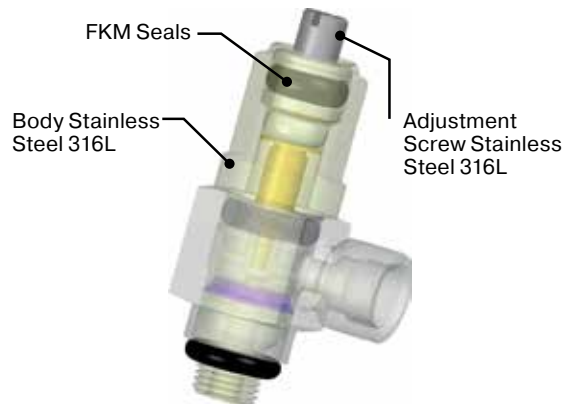

Assembly Instructions

1. Cut tubing squarely – maximum of 15° angle allowable.
2. Check that port or mating part is clean and free of debris.
3. Mark tubing to appropriate tube insertion length. (see Tube Insertion Chart on page N22)
4. Insert tubing until it bottoms
5. Pull on tubing to verify it is fully inserted
6. To disassemble, simply press release button, hold against body and pull tubing out of fitting.

Operation

Exhaust Model with External Adjustment

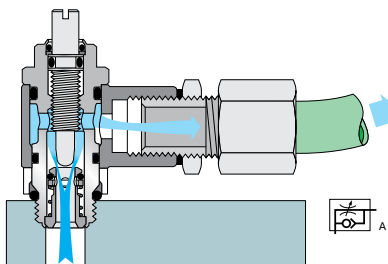

Bi-Directional Model with External Adjustment

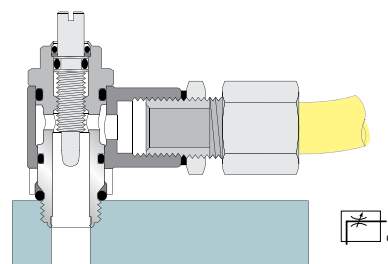

WARNING These products can expose you to chemicals including NICKEL or LEAD, which are known to the state of California to cause cancer, and LEAD which is known to cause birth defects or other reproductive harm. For more information go to www.P65Warnings.ca.gov.



[Click here for CADs, Product Specifications or to Configure Parts Online](#)

**7810, 7812, 7815, 7817 Threaded Port Knobless
Stainless Steel Flow Control - NPT, UNF**

| PART NO. METER OUT | PART NO. BI-DIRECTIONAL | C | E | E1 | F | H | J | L | WT. OZ. |
|-----------------------|----------------------------|-------|-----|-----|----|------|------|------|------------|
| 7810 20 20 | 7812 20 20 | 10-32 | .16 | .16 | 8 | .94 | .35 | .43 | .95 |
| 7815 11 11 | 7817 11 11 | 1/8 | .20 | .31 | 13 | 1.50 | .59 | .67 | 1.23 |
| 7815 14 14 | 7817 14 14 | 1/4 | .31 | .47 | 17 | 1.38 | .71 | .94 | 1.69 |
| 7815 18 18 | 7817 18 18 | 3/8 | .28 | .55 | 20 | 1.89 | .87 | 1.06 | 2.08 |
| 7815 22 22 | 7817 22 22 | 1/2 | .31 | .59 | 23 | 2.52 | 1.10 | 1.22 | 2.68 |

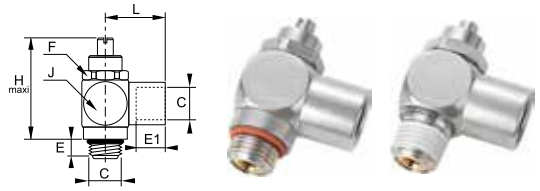

**7810, 7812, Threaded Port Knobless
Stainless Steel Flow Control - BSPP Metric**

| PART NO. METER OUT | PART NO. BI-DIRECTIONAL | C | E | E1 | F | H | J | L | WT. KG. |
|-----------------------|----------------------------|--------|---|----|----|----|----|----|------------|
| 7810 19 19 | 7812 19 19 | M5X0.8 | 4 | 4 | 8 | 24 | 10 | 11 | .027 |
| 7810 10 10 | 7812 10 10 | G1/8 | 5 | 8 | 13 | 38 | 15 | 17 | .035 |
| 7810 13 13 | 7812 13 13 | G1/4 | 8 | 12 | 17 | 40 | 18 | 24 | .048 |
| 7810 17 17 | 7812 17 17 | G3/8 | 7 | 12 | 20 | 53 | 22 | 24 | .059 |
| 7810 21 21 | 7812 21 21 | G1/2 | 8 | 15 | 23 | 69 | 28 | 31 | .076 |

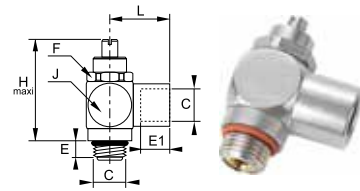

**7835 Push-to-Connect Knobless
Stainless Steel Flow Control Tube to NPT**

| PART NO. METER OUT | ØD | C | F MM | H | J | L | WT. OZ. |
|-----------------------|-----|-----|---------|------|-----|------|------------|
| 7835 56 11 | 1/4 | 1/8 | 13 | 1.30 | .59 | .87 | 1.69 |
| 7835 60 18 | 3/8 | 3/8 | 20 | 1.89 | .87 | 1.26 | 2.68 |

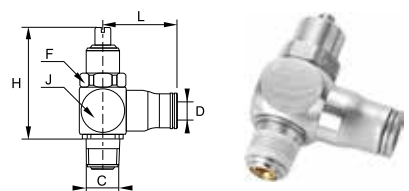

- A
- B
- C
- D
- E
- F
- G
- H
- I
- J
- K
- L
- M
- N
- O

WARNING These products can expose you to chemicals including NICKEL or LEAD, which are known to the state of California to cause cancer, and LEAD which is known to cause birth defects or other reproductive harm. For more information go to www.P65Warnings.ca.gov.



A

B

C

D

E

F

G

H

I

J

K

L

M

N

O



In-Line Check Valves

Parker's In-Line Check Valves allows air to pass in one direction while blocking flow in the other direction. The body of the fitting contains an arrow to indicate the direction of flow.

Product Features:

- Nylon/Nickel-plated brass body
- VC – Acetal body
- Stainless steel gripping ring
- Nickel-plated brass threads
- Nitrile O-ring
- EPDM O-ring (VC)

Markets:

- Factory/Process Automation
- Packaging
- Petrochemical
- Pneumatics
- Semi-Conductor

Applications:

- Robotics
- Packaging
- Textile
- Machine Tools
- Pneumatic Systems
- Vacuum

Specifications:

| | |
|--------------------------|--|
| Pressure Range | 15 to 145 psi (1.0 to 9.9 bar) |
| Temperature Range | +34° to +150° F (+1.1° to 65.5° C) |
| Cracking Pressure | PLCK – 7 PSI (0.4 bar), VC – 1/3 PSI (0.02 bar) |

Compatible Tubing:

- Semi-rigid nylon
- Polyurethane 95 Durometer Shore A
- Nylon
- Fluoropolymer

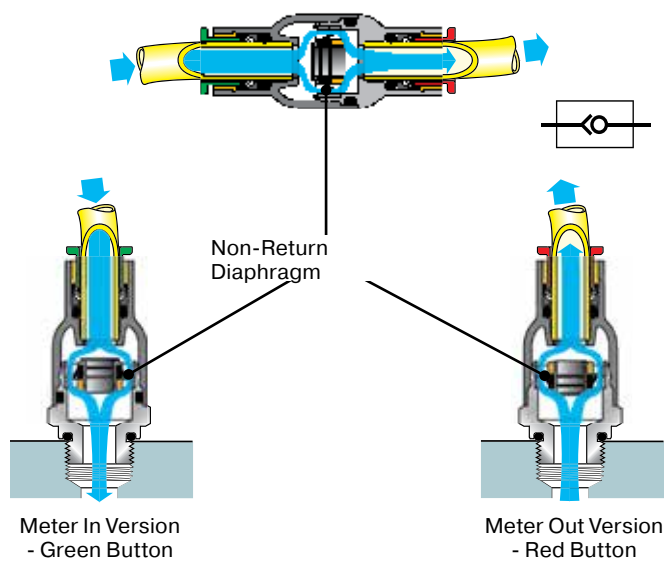

Assembly Instructions

1. Cut tubing squarely – maximum of 15° angle allowable.
2. Check that port or mating part is clean and free of debris.
3. Mark tubing to appropriate tube insertion length. (see Tube Insertion Chart on page N22)
4. Insert tubing until it bottoms
5. Pull on tubing to verify it is fully inserted
6. To disassemble, simply press release button, hold against body and pull tubing out of fitting.

WARNING These products can expose you to chemicals including NICKEL or LEAD, which are known to the state of California to cause cancer, and LEAD which is known to cause birth defects or other reproductive harm. For more information go to www.P65Warnings.ca.gov.



[Click here for CADs, Product Specifications or to Configure Parts Online](#)

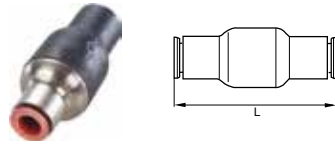

32PLCK In-Line Check Valve

| PART NO. | TUBE SIZE IN | L |
|----------|--------------|------|
| 32PLCK-4 | 1/4 | 1.61 |
| 32PLCK-6 | 3/8 | 2.50 |

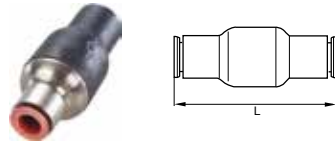

32PLCK In-Line Check Valve

| PART NO. | TUBE SIZE MM | L |
|------------------|--------------|------|
| 32PLCK-4M (5/32) | 4 | 38.5 |
| 32PLCK-6M | 6 | 41.0 |
| 32PLCK-8M (5/16) | 8 | 51.5 |
| 32PLCK-10M | 10 | 63.5 |
| 32PLCK-12M | 12 | 66.5 |

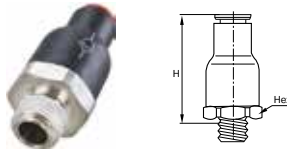

W68PLCK Male Check Valve

| PART NO. | TUBE SIZE IN | NPT / UNF | HEX MM | H |
|--------------|--------------|-----------|--------|------|
| W68PLCK-4M-2 | 5/32 | 1/8 | 16 | 1.12 |
| W68PLCK-4-2 | 1/4 | 1/8 | 19 | 1.42 |
| W68PLCK-4-4 | 1/4 | 1/4 | 19 | 1.42 |
| W68PLCK-6-4 | 3/8 | 1/4 | 23 | 1.65 |
| W68PLCK-6-6 | 3/8 | 3/8 | 23 | 1.65 |

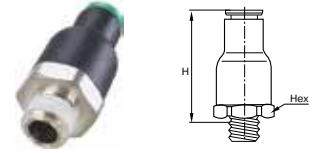

W68PLCKI Male Check Valve Meter In

| PART NO. | TUBE SIZE IN | NPT / UNF | HEX MM | H |
|---------------|--------------|-----------|--------|------|
| 68PLCKI-4M-0 | 5/32 | 10-32 | 9 | 1.26 |
| W68PLCKI-4M-2 | 5/32 | 1/8 | 16 | 1.12 |
| W68PLCKI-4-2 | 1/4 | 1/8 | 19 | 1.42 |
| W68PLCKI-4-4 | 1/4 | 1/4 | 19 | 1.42 |
| W68PLCKI-6-4 | 3/8 | 1/4 | 23 | 1.65 |
| W68PLCKI-6-6 | 3/8 | 3/8 | 23 | 1.65 |

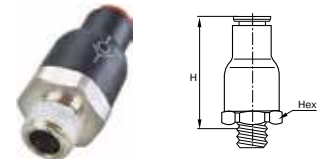

W68PLCK Male Check Valve Meter Out - BSPT

| PART NO. | TUBE SIZE MM | BSPT | HEX 1 | H |
|----------------|--------------|------|-------|------|
| W68PLCK-4M-2R | 4 | 1/8 | 16 | 28.5 |
| W68PLCK-6M-2R | 6 | 1/8 | 16 | 30.5 |
| W68PLCK-6M-4R | 6 | 1/4 | 16 | 30.5 |
| W68PLCK-8M-2R | 8 | 1/8 | 19 | 36.0 |
| W68PLCK-8M-4R | 8 | 1/4 | 19 | 36.0 |
| W68PLCK-12M-6R | 12 | 3/8 | 23 | 42.0 |

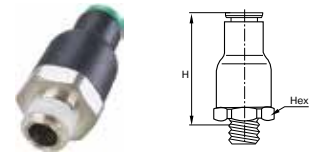

W68PLCKI Male Check Valve Meter In - BSPT

| PART NO. | TUBE SIZE MM | BSPT | HEX 1 | H |
|----------------|--------------|------|-------|------|
| W68PLCKI-4M-2R | 4 | 1/8 | 16 | 28.5 |
| W68PLCKI-6M-2R | 6 | 1/8 | 16 | 30.5 |
| W68PLCKI-6M-4R | 6 | 1/4 | 16 | 30.5 |
| W68PLCKI-8M-2R | 8 | 1/8 | 19 | 36.0 |
| W68PLCKI-8M-4R | 8 | 1/4 | 19 | 36.0 |

WARNING These products can expose you to chemicals including NICKEL or LEAD, which are known to the state of California to cause cancer, and LEAD which is known to cause birth defects or other reproductive harm. For more information go to www.P65Warnings.ca.gov.



Click here for CADs, Product Specifications or to Configure Parts Online

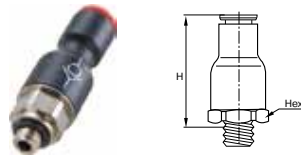

68PLCK Male Check Valve Meter Out - BSPP

| PART NO. | TUBE SIZE MM | BSPP | HEX 1 | H |
|--------------|--------------|--------|-------|------|
| 68PLCK-4M-M5 | 4 | M5X0.8 | 9 | 32.0 |
| 68PLCK-6M-2G | 6 | 1/8 | 16 | 30.5 |
| 68PLCK-6M-4G | 6 | 1/4 | 16 | 30.5 |
| 68PLCK-8M-2G | 8 | 1/8 | 19 | 36.0 |
| 68PLCK-8M-4G | 8 | 1/4 | 19 | 36.0 |

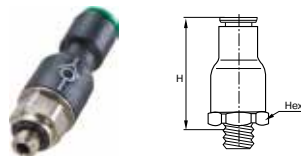

68PLCKI Male Check Valve Meter In - BSPP

| PART NO. | TUBE SIZE MM | BSPP | HEX 1 | H |
|----------------|--------------|------|-------|------|
| 68PLCKI-6M-2G | 6 | 1/8 | 16 | 30.5 |
| 68PLCKI-8M-2G | 8 | 1/8 | 19 | 36.0 |
| 68PLCKI-8M-4G | 8 | 1/4 | 19 | 36.0 |
| 68PLCKI-12M-6G | 12 | 3/8 | 23 | 42.0 |
| 68PLCKI-12M-8G | 12 | 1/2 | 23 | 44.0 |

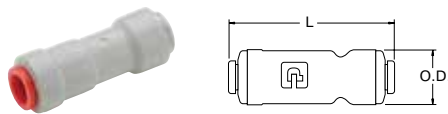

VC – Check Valve

| PART NO. | TUBE SIZE IN | L | O.D. |
|----------|--------------|------|------|
| A4VC4-MG | 1/4 | 2.00 | .66 |
| A5VC5-MG | 5/16 | 2.10 | .70 |
| A6VC6-MG | 3/8 | 2.15 | .80 |
| A8VC8-MG | 1/2 | 2.68 | .91 |

WARNING These products can expose you to chemicals including NICKEL or LEAD, which are known to the state of California to cause cancer, and LEAD which is known to cause birth defects or other reproductive harm. For more information go to www.P65Warnings.ca.gov.



Stainless Steel Check Valves

Parker's Stainless Steel Check Valves are ideally suited to harsh environments and for conveying industrial fluids. These check valves allow fluids to flow in one direction and prevent them from flowing in the other.

Product Features:

- 316L Stainless Steel Body & Poppet
- 302 Stainless Steel Spring
- FKM Seals
- Smooth external surfaces contribute to equipment cleanliness
- Suitable for use in corrosive environments

Markets:

- Factory/Process Automation
- Life Science
- Food Processing
- Water And Beverage
- Petrochemical

Applications:

- Pneumatics
- Machine Tools
- Processing
- Chemical
- Printing

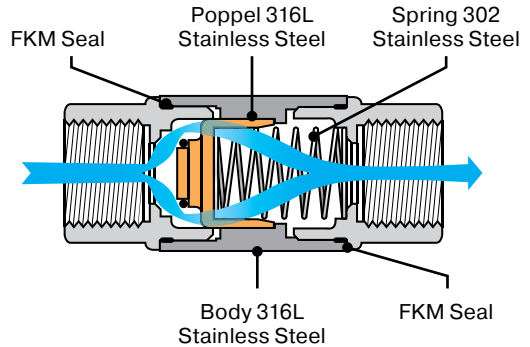

Specifications:

Pressure Range 7 to 580 PSI (0.4 to 39.9 bar)

Cracking Pressure 3.6 PSI (0.2 bar)

Temperature Range -4° to +356° F (-20° to +180° C)

Flow Characteristics

| MODEL | WATER FLOW AT 90 PSI | KV |
|-------|----------------------|------|
| 1/8 | .67 SCFM | 1.60 |
| 1/4 | .70 SCFM | 1.69 |
| 3/8 | 1.26 SCFM | 3.01 |
| 1/2 | 1.29 SCFM | 3.10 |
| 3/4 | 2.33 SCFM | 5.59 |
| 1 | 3.27 SCFM | 7.86 |

WARNING These products can expose you to chemicals including NICKEL or LEAD, which are known to the state of California to cause cancer, and LEAD which is known to cause birth defects or other reproductive harm. For more information go to www.P65Warnings.ca.gov.



[Click here for CADs, Product Specifications or to Configure Parts Online](#)

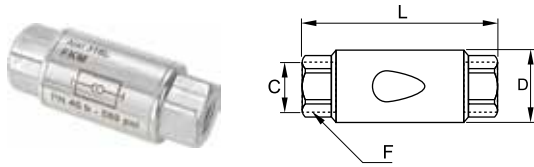

4890 Unidirectional Female - BSPP

| PART NO. | C | DN | D MM | F MM | L MM | WT. KG. |
|------------|------|----|------|------|------|---------|
| 4890 10 10 | G1/8 | 10 | 22 | 17 | 50 | .084 |
| 4890 13 13 | G1/4 | 10 | 22 | 17 | 50 | .074 |
| 4890 17 17 | G3/8 | 15 | 30 | 22 | 67 | .182 |
| 4890 21 21 | G1/2 | 15 | 30 | 25 | 71 | .196 |
| 4890 27 27 | G3/4 | 20 | 42 | 32 | 84 | .288 |
| 4890 34 34 | G1 | 25 | 42 | 38 | 90 | .416 |

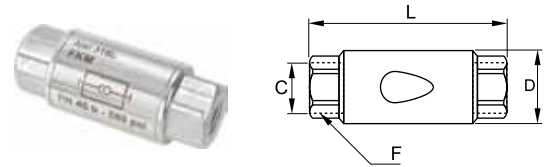

4895 Unidirectional Female - NPT

| PART NO. | C | DN | D MM | F MM | L MM | WT. KG. |
|------------|-----|----|------|------|------|---------|
| 4895 11 11 | 1/8 | 10 | 22 | 18 | 50 | .084 |
| 4895 14 14 | 1/4 | 10 | 22 | 18 | 54 | .080 |
| 4895 18 18 | 3/8 | 15 | 30 | 22 | 73 | .198 |
| 4895 22 22 | 1/2 | 15 | 30 | 25 | 77 | .213 |

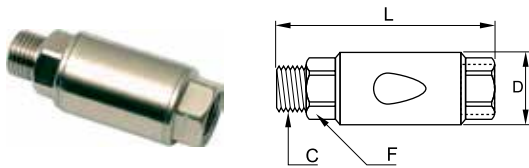

4891 Unidirectional Male to Female - BSPP

| PART NO. | C | DN | D MM | F MM | L MM | WT. KG. |
|------------|------|----|------|------|------|---------|
| 4891 10 10 | G1/8 | 10 | 22 | 17 | 56 | .086 |
| 4891 13 13 | G1/4 | 10 | 22 | 17 | 58 | .082 |
| 4891 17 17 | G3/8 | 15 | 30 | 22 | 75 | .190 |
| 4891 21 21 | G1/2 | 15 | 30 | 25 | 79 | .280 |
| 4891 27 27 | G3/4 | 20 | 42 | 32 | 98 | .302 |
| 4891 34 34 | G1 | 25 | 42 | 38 | 104 | .424 |

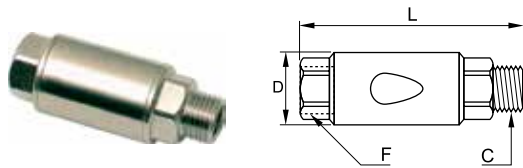

4892 Unidirectional Female to Male - BSPP

| PART NO. | C | DN | D MM | F MM | L MM | WT. KG. |
|------------|------|----|------|------|------|---------|
| 4892 10 10 | G1/8 | 10 | 22 | 17 | 56 | .086 |
| 4892 13 13 | G1/4 | 10 | 22 | 17 | 58 | .082 |
| 4892 17 17 | G3/8 | 15 | 30 | 22 | 75 | .190 |
| 4892 21 21 | G1/2 | 15 | 30 | 25 | 79 | .280 |
| 4892 27 27 | G3/4 | 20 | 42 | 32 | 98 | .302 |
| 4892 34 34 | G1 | 25 | 42 | 38 | 104 | .424 |

WARNING These products can expose you to chemicals including NICKEL or LEAD, which are known to the state of California to cause cancer, and LEAD which is known to cause birth defects or other reproductive harm. For more information go to www.P65Warnings.ca.gov.



A

B

C

D

E

F

G

H

I

J

K

L

M

N

O



Piloted Operated Check Valves

Parker's Piloted Operated Check Valves are designed to protect installations. If the compressed air supply is removed they lock the air supply to the cylinder, maintaining it in position.

Product Features:

- Orientable and adjustable through 3 axis
- Can be integrated into any installation configuration
- Vent saves time on restart after maintenance operations
- Multi-purpose fitting
 - Piloted non-return valve
 - Flow control regulator
 - Manual exhaust

Markets:

- Factory/Process Automation
- Food Processing
- Pneumatics
- Automotive

Applications:

- Pneumatics
- Machine Tools
- Processing
- Packaging
- Assembly

Specifications:

Pressure Range 14 to 145 PSI (0.9 to 9.9 bar)

Cracking Pressure 4.3 PSI (0.2 bar)

Temperature Range +23° to +140° F (-5° to 60° C)

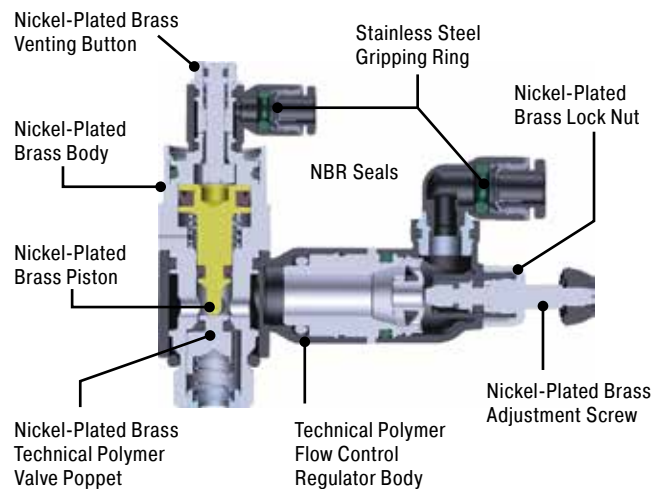

Assembly Instructions

1. Cut tubing squarely – maximum of 15° angle allowable.
2. Check that port or mating part is clean and free of debris.
3. Mark tubing to appropriate tube insertion length. (see Tube Insertion Chart on page N22)
4. Insert tubing until it bottoms
5. Pull on tubing to verify it is fully inserted
6. To disassemble, simply press release button, hold against body and pull tubing out of fitting.

WARNING These products can expose you to chemicals including NICKEL or LEAD, which are known to the state of California to cause cancer, and LEAD which is known to cause birth defects or other reproductive harm. For more information go to www.P65Warnings.ca.gov.



[Click here for CADs, Product Specifications or to Configure Parts Online](#)

- A
- B
- C
- D
- E
- F
- G
- H
- I
- J
- K
- L
- M
- N
- O

Operation

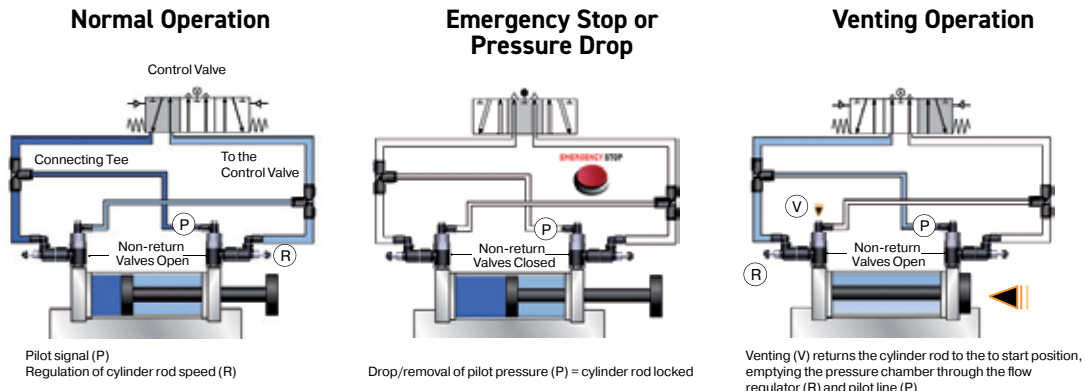

7892 Piloted Non-Return Valve - BSPP

| PART NO. | D MM | C | E MM | F MM | G MM | H MM | H1 MM | H2 MM | L MM | WT. KG. |
|------------|------|------|------|------|------|------|-------|-------|------|---------|
| 7892 06 10 | 6 | G1/8 | 6 | 13 | 14 | 42 | 30 | 7 | 21 | .028 |
| 7892 06 13 | 6 | G1/4 | 9 | 17 | 18.5 | 45 | 32 | 9 | 23 | .049 |
| 7892 08 10 | 8 | G1/8 | 6 | 13 | 14 | 42 | 29 | 9 | 25 | .029 |
| 7892 08 13 | 8 | G1/4 | 9 | 17 | 18.5 | 45 | 32 | 9 | 27 | .051 |
| 7892 08 17 | 8 | G3/8 | 6 | 20 | 22.5 | 57 | 41 | 11 | 28 | .093 |
| 7892 10 17 | 10 | G3/8 | 6 | 20 | 22.5 | 57 | 41 | 11 | 31 | .094 |
| 7892 10 21 | 10 | G1/2 | 10 | 24 | 28 | 63 | 47 | 16 | 36 | .172 |
| 7892 12 21 | 12 | G1/2 | 10 | 24 | 28 | 63 | 47 | 16 | 36 | .162 |

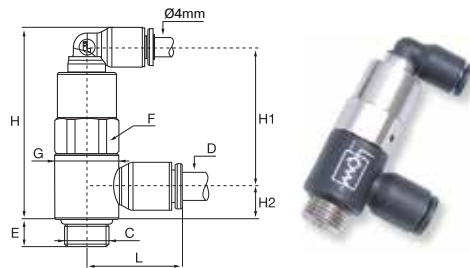

7894 Piloted Non-Return Valve with Flow Regulator and Exhaust - BSPP

| PART NO. | D MM | C | E MM | F1 MM | F2 MM | G MM | H MM | H1 MM | H2 MM | H3 MM | L MIN | L MAX | L MM | WT. KG. |
|------------|------|------|------|-------|-------|------|------|-------|-------|-------|-------|-------|------|---------|
| 7894 06 10 | 6 | G1/8 | 6 | 13 | 8 | 14 | 46 | 7 | 24 | 31 | 48.5 | 51 | 16 | .049 |
| 7894 06 13 | 6 | G1/4 | 9 | 17 | 10 | 18.5 | 49 | 11 | 18 | 31 | 59.5 | 65 | 17 | .081 |
| 7894 08 10 | 8 | G1/8 | 6 | 13 | 8 | 14 | 46 | 7 | 27 | 31 | 48.5 | 51 | 22 | .050 |
| 7894 08 13 | 8 | G1/4 | 9 | 17 | 10 | 18.5 | 49 | 11 | 23 | 31 | 59.5 | 65 | 23 | .084 |
| 7894 08 17 | 8 | G3/8 | 6 | 20 | 14 | 22.5 | 69 | 13 | 21 | 40 | 67.5 | 73 | 23 | .148 |
| 7894 10 17 | 10 | G3/8 | 6 | 20 | 14 | 22.5 | 69 | 13 | 29 | 40 | 67.5 | 73 | 26 | .152 |
| 7894 10 21 | 10 | G1/2 | 10 | 24 | 17 | 28 | 76 | 12.5 | 26 | 47 | 74 | 81 | 26 | .234 |
| 7894 12 21 | 12 | G1/2 | 10 | 24 | 17 | 28 | 76 | 12.5 | 27 | 47 | 74 | 81 | 30 | .236 |

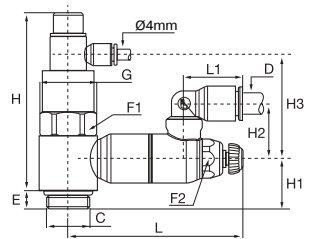

WARNING These products can expose you to chemicals including NICKEL or LEAD, which are known to the state of California to cause cancer, and LEAD which is known to cause birth defects or other reproductive harm. For more information go to www.P65Warnings.ca.gov.

A

B

C

D

E

F

G

H

I

J

K

L

M

N

O



Pneumatic Slide Valves

Parker's Slide Valves may be used to effect an immediate isolation of the air line by venting the system to atmosphere. By moving the sleeve in one direction, the air is free to pass through the slide valve to the system. By moving it in the opposite direction, the supply is shut off and the downstream air is allowed to exhaust to the atmosphere.

Product Features:

- Lightweight due to use of aluminum
- Nitrile Seals
- Immediate identification of the venting system by the color (red)
- Uni-directional use ensures the downstream circuit is vented
- Operated in the plane of the tube

Markets:

- Factory/Process Automation
- Food Processing
- Packaging

Applications:

- Pneumatics
- Conveyors
- Packaging
- Textile
- Plastics Engineering

Specifications:

Pressure Range Up to 230 PSI (15.8 bar)

Temperature Range +15° to +175° F (-9.4° to +79.4° C)

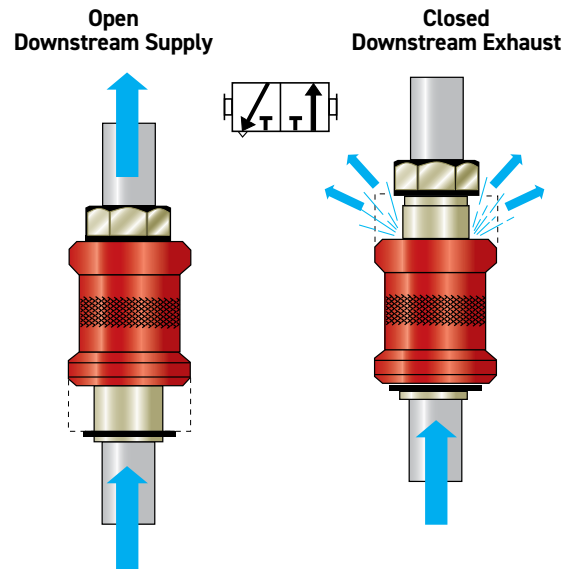

WARNING These products can expose you to chemicals including NICKEL or LEAD, which are known to the state of California to cause cancer, and LEAD which is known to cause birth defects or other reproductive harm. For more information go to www.P65Warnings.ca.gov.



[Click here for CADs, Product Specifications or to Configure Parts Online](#)

A

0660 Female Slide Valve - NPT

| PART NO. | C | DN | F | G | L | WT. OZ. |
|------------|-----|-----|------|------|------|---------|
| 0660 04 11 | 1/8 | .16 | .55 | .98 | 1.89 | 2.12 |
| 0660 07 14 | 1/4 | .27 | .67 | 1.18 | 2.28 | 3.71 |
| 0660 10 18 | 3/8 | .39 | .87 | 1.38 | 2.68 | 6.18 |
| 0660 14 22 | 1/2 | .55 | 1.06 | 1.57 | 3.15 | 9.53 |

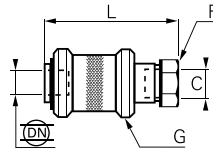

B

0661 Male to Female Slide Valve - NPT

| PART NO. | C | DN | F | G | L | WT. OZ. |
|------------|-----|-----|------|------|------|---------|
| 0661 04 11 | 1/8 | .16 | .55 | .98 | 2.19 | 2.47 |
| 0661 07 14 | 1/4 | .27 | .67 | 1.18 | 2.75 | 4.59 |
| 0661 10 18 | 3/8 | .39 | .87 | 1.38 | 3.21 | 7.59 |
| 0661 14 22 | 1/2 | .55 | 1.06 | 1.57 | 3.75 | 11.30 |

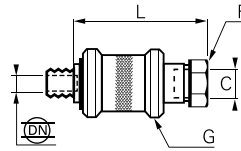

C

D

E

F

0669 Female Slide Valve - BSPP

| PART NO. | C | DN | F MM | G MM | L MM | WT. KG. |
|------------|--------|----|------|------|------|---------|
| 0669 02 19 | M5X0.8 | 2 | 10 | 14 | 30.5 | .045 |
| 0669 04 10 | G1/8 | 4 | 14 | 25 | 48 | .051 |
| 0669 07 13 | G1/4 | 7 | 19 | 30 | 58 | .084 |
| 0669 10 17 | G3/8 | 10 | 22 | 35 | 68 | .153 |
| 0669 14 21 | G1/2 | 14 | 27 | 40 | 80 | .227 |
| 0669 19 27 | G3/4 | 19 | 32 | 50 | 83 | .242 |

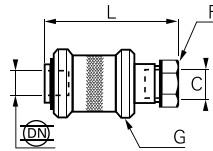

G

H

I

J

K

L

M

N

O

WARNING These products can expose you to chemicals including NICKEL or LEAD, which are known to the state of California to cause cancer, and LEAD which is known to cause birth defects or other reproductive harm. For more information go to www.P65Warnings.ca.gov.

Quick Exhaust Valve



Parker's Quick Exhaust Valve increases the return speed of the cylinder rod by allowing the exhaust to pass directly to atmosphere.

Product Features:

- Nickel plated brass body
- Nylon seal
- Polyurethane piston
- Reduction in cycle times: return speed improved
- Excellent exhaust capacity
- Ideal for applications in restrictive environments

Markets:

- Factory/Process Automation
- Packaging
- Industrial
- Pulp & Paper

Applications:

- Pneumatics
- Conveyors
- Packaging
- Textile
- Plastics Engineering

Specifications:

Pressure Range 10 to 150 PSI (0.6 to 10.3 bar)

Temperature Range 0° to +160° F (-17.7 to +71.1° C)

7970 Quick Exhaust Valve Threaded Ports - BSPP

| PART NO. | C | F | H | H1 | L | WT.OZ. |
|------------|----------|----|------|------|----|--------|
| 7970 19 19 | M5 x 0.8 | 10 | 24.8 | 15.6 | 4 | .029 |
| 7970 10 10 | G1/8 | 14 | 42 | 28 | 8 | .084 |
| 7970 13 13 | G1/4 | 19 | 53 | 34.5 | 11 | .148 |
| 7970 17 17 | G3/8 | 21 | 58 | 36 | 12 | .153 |
| 7970 21 21 | G1/2 | 26 | 71 | 44 | 14 | .316 |
| 7970 27 27 | G3/4 | 32 | 86 | 52 | 18 | .449 |
| 7970 34 34 | G1 | 38 | 94 | 56 | 19 | .531 |

7982 Quick Exhaust Valve Threaded Ports - NPT

| PART NO. | C | F | H | H1 | L | WT. OZ. |
|------------|-----|----|------|------|-----|---------|
| 7982 11 11 | 1/8 | 14 | 1.69 | 1.10 | .28 | 2.97 |
| 7982 14 14 | 1/4 | 19 | 2.11 | 1.38 | .37 | 5.18 |
| 7982 18 18 | 3/8 | 20 | 2.19 | 1.42 | .35 | 5.64 |
| 7982 22 22 | 1/2 | 26 | 2.83 | 1.77 | .55 | 11.29 |

Operation:

Mounted on Cylinder

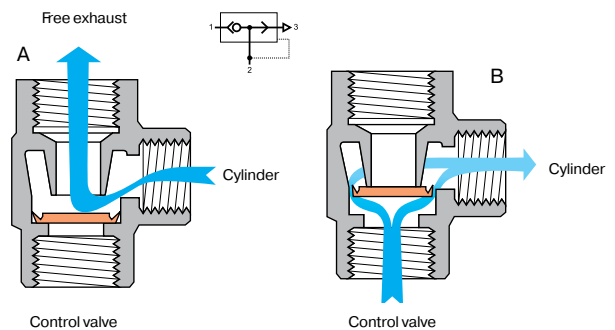

Installation Diagram

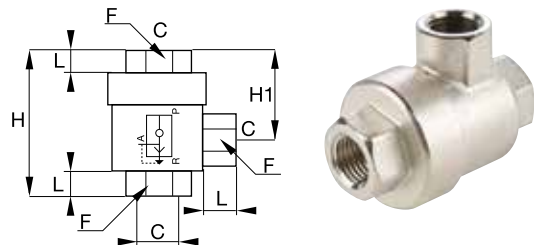
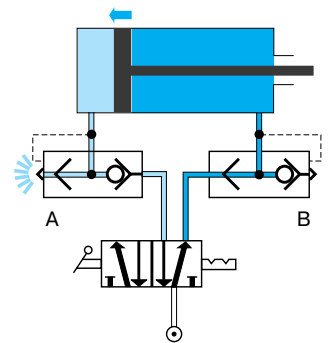

WARNING These products can expose you to chemicals including NICKEL or LEAD, which are known to the state of California to cause cancer, and LEAD which is known to cause birth defects or other reproductive harm. For more information go to www.P65Warnings.ca.gov.

- A
- B
- C
- D
- E
- F
- G
- H
- I
- J
- K
- L
- M
- N
- O

A

B

C

D

E

F

G

H

I

J

K

L

M

N

O

Blocking Valves



Parker's Blocking Valves prevents damage to work and equipment in the event of a loss of pressure. Blocking valves which are mounted in pairs on a cylinder lock the piston by simultaneously cutting off the supply and exhaust.

Product Features:

- Treated brass body
- Stainless steel gripping ring
- Nickel-plated brass threads
- NBR seals
- Silicone free

Markets:

- Factory/Process Automation
- Packaging
- Petrochemical
- Automotive Process

Applications:

- Robotics
- Packaging
- Textile
- Machine Tools

Compatible Tubing:

- Semi-rigid nylon
- Polyurethane 95 Durometer Shore A
- Nylon
- Fluoropolymer

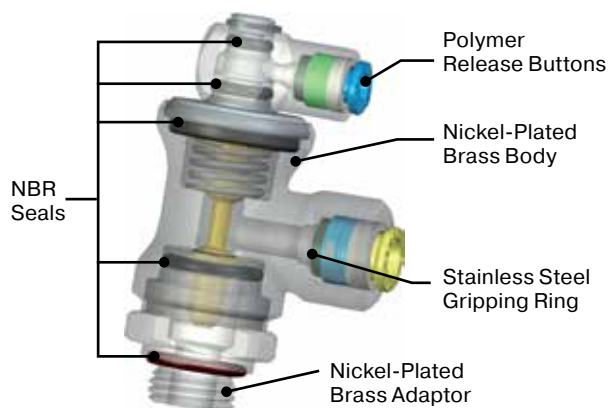

Specifications:

Pressure Range 15 to 145 PSI (1.0 to 9.9 bar)

Temperature Range -4° to +160° F (-20° to +71.1° C)

Leak Rate <3.2CCM

Number of Cycles >10 Million at 68°F and 1 HZ

Assembly Instructions

1. Cut tubing squarely – maximum of 15° angle allowable.
2. Check that port or mating part is clean and free of debris.
3. Mark tubing to appropriate tube insertion length. (see Tube Insertion Chart on page N22)
4. Insert tubing until it bottoms
5. Pull on tubing to verify it is fully inserted
6. To disassemble, simply press release button, hold against body and pull tubing out of fitting.

Operation

Cylinder in Operation
(pilot signal active)

Cylinder Blocked
(pilot signal removed)

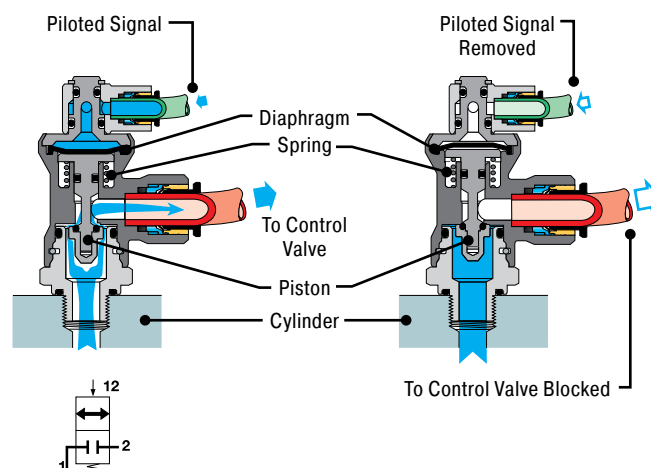

WARNING These products can expose you to chemicals including NICKEL or LEAD, which are known to the state of California to cause cancer, and LEAD which is known to cause birth defects or other reproductive harm. For more information go to www.P65Warnings.ca.gov.



Click here for CADs, Product Specifications or to Configure Parts Online

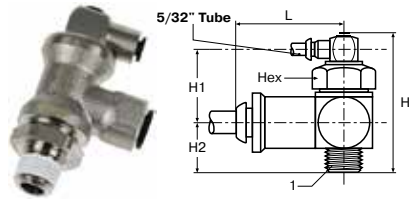

FC601 Push-to-Connect Lock Out Valves

| PART NO. | TUBE SIZE IN | NPT | HEX MM | H | H1 | H2 | L |
|-----------|--------------|-----|--------|------|------|------|------|
| FC601-4-2 | 1/4 | 1/8 | 21 | 2.03 | 1.24 | .79 | 1.10 |
| FC601-4-4 | 1/4 | 1/4 | 21 | 2.03 | 1.24 | .79 | 1.10 |
| FC601-6-6 | 3/8 | 3/8 | 24 | 2.19 | 1.14 | 1.04 | 1.38 |
| FC601-8-8 | 1/2 | 1/2 | 24 | 2.19 | 1.14 | 1.04 | 1.69 |

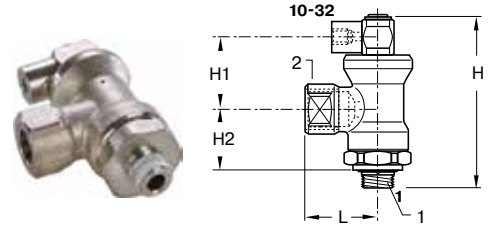

FC602 Threaded Port Lock Out Valves

| PART NO. | 1 NPT | 2 NPT | HEX MM | H | H1 | H2 | L |
|----------|-------|-------|--------|------|------|------|------|
| FC602-2 | 1/8 | 1/8 | 21 | 2.03 | 1.24 | .79 | 1.04 |
| FC602-4 | 1/4 | 1/4 | 21 | 2.03 | 1.24 | .79 | 1.04 |
| FC602-6 | 3/8 | 3/8 | 24 | 2.19 | 1.14 | 1.04 | 1.34 |
| FC602-8 | 1/2 | 1/2 | 24 | 2.19 | 1.14 | 1.04 | 1.57 |

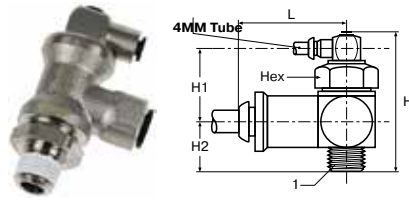

FC601 Push-to-Connect Lock-Out Valve - BSPT

| PART NO. | TUBE SIZE MM | BSPT | HEX | H | H1 | H2 | L |
|--------------|--------------|------|-----|----|------|------|------|
| FC601-6M-2R | 6 | 1/8 | 21 | 53 | 24.5 | 21.0 | 28.0 |
| FC601-6M-4R | 6 | 1/4 | 21 | 53 | 24.5 | 21.0 | 28.0 |
| FC601-8M-4R | 8 | 1/4 | 21 | 53 | 24.5 | 21.0 | 28.0 |
| FC601-8M-6R | 8 | 3/8 | 24 | 56 | 25.0 | 23.0 | 34.5 |
| FC601-10M-6R | 10 | 3/8 | 24 | 56 | 25.0 | 23.0 | 35.0 |
| FC601-12M-8R | 12 | 1/2 | 24 | 56 | 25.0 | 23.0 | 37.5 |

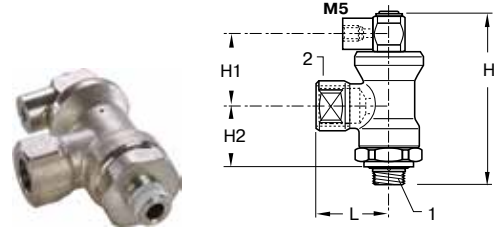

FC608 Threaded Port Lock-Out Valve - BSPT

| PART NO. | BSPT 1 | BSPT 2 | HEX | H | H1 | H2 | L |
|-------------|--------|--------|-----|------|------|------|------|
| FC608-4R-2R | 1/8 | 1/4 | 21 | 51.5 | 31.5 | 20.0 | 26.5 |
| FC608-4R-4R | 1/4 | 1/4 | 21 | 51.5 | 31.5 | 20.0 | 26.5 |
| FC608-6R-6R | 3/8 | 3/8 | 24 | 55.5 | 29.0 | 26.5 | 34.0 |
| FC608-8R-8R | 1/2 | 1/2 | 24 | 55.5 | 29.0 | 26.5 | 40.0 |

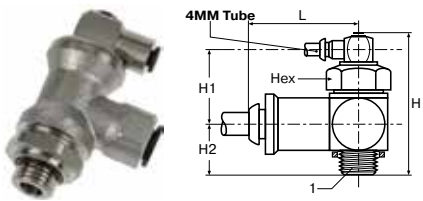

FC601 Push-to-Connect Lock-Out Valve - BSPP

| PART NO. | TUBE SIZE MM | BSPP | HEX | H | H1 | H2 | L |
|--------------|--------------|------|-----|----|------|------|------|
| FC601-6M-2G | 6 | 1/8 | 21 | 53 | 24.5 | 21.0 | 28.0 |
| FC601-6M-4G | 6 | 1/4 | 21 | 53 | 24.5 | 21.0 | 28.0 |
| FC601-8M-4G | 8 | 1/4 | 21 | 53 | 24.5 | 21.0 | 28.0 |
| FC601-8M-6G | 8 | 3/8 | 24 | 56 | 25.0 | 23.0 | 34.5 |
| FC601-10M-6G | 10 | 3/8 | 24 | 56 | 25.0 | 23.0 | 35.0 |
| FC601-12M-8G | 12 | 1/2 | 24 | 56 | 25.0 | 23.0 | 37.5 |

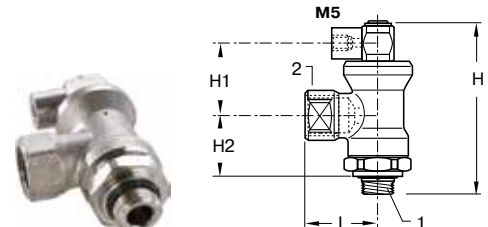

FC608 Threaded Port Lock-Out Valve - BSPP

| PART NO. | BSPP 1 | BSPP 2 | HEX | H | H1 | H2 | L |
|-------------|--------|--------|-----|----|------|------|------|
| FC608-4G-2G | 1/8 | 1/4 | 21 | 53 | 24.5 | 21.0 | 28.0 |
| FC608-4G-4G | 1/4 | 1/4 | 21 | 53 | 24.5 | 21.0 | 28.0 |
| FC608-6G-6G | 3/8 | 3/8 | 24 | 56 | 25.0 | 23.0 | 34.0 |
| FC608-8G-8G | 1/2 | 1/2 | 24 | 56 | 25.0 | 23.0 | 41.0 |

WARNING These products can expose you to chemicals including NICKEL or LEAD, which are known to the state of California to cause cancer, and LEAD which is known to cause birth defects or other reproductive harm. For more information go to www.P65Warnings.ca.gov.



A

B

C

D

E

F

G

H

I

J

K

L

M

N

O

Manually-Operated Valves



Parker Legris' manually-operated valves offer a reliable and durable system for opening and closing the circuit when the system has to be switched frequently. They provide a significant reduction in the time needed to work on pneumatic circuits.

Product Features:

Manual Switch-Operated Valves

- Downstream control supply provided by simply moving the lever
- 2 models available to provide the best solution for the system:
 - 3/2: opening, closing, venting
- Compact and ergonomic (can be positioned through 360°)
- Silicone-Free

Markets:

- Factory/Process Automation
- Packaging
- Industrial
- Pulp & Paper

Applications:

- Robotics
- Conveyors
- Textile
- Plastics Engineering
- Printing
- Pneumatics
- Packaging

Specifications:

| | |
|----------------------------|-------------------------------|
| Compatible Fluids | Compressed air |
| Working Pressure | 230 psi (15.8 bar) |
| Working Temperature | 15° to 175° F (-10° to 80° C) |

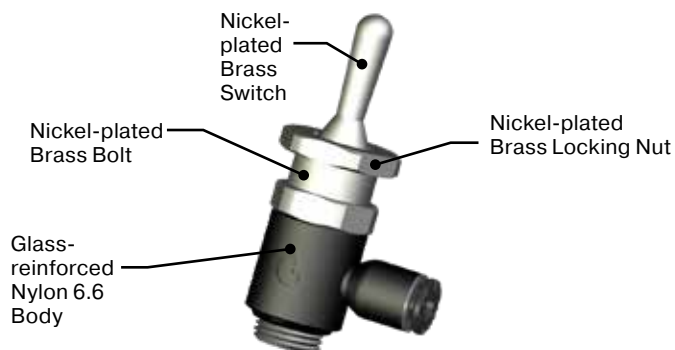

Operation

Switch-Operated Valves

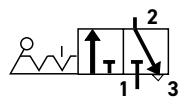

Open

Closed

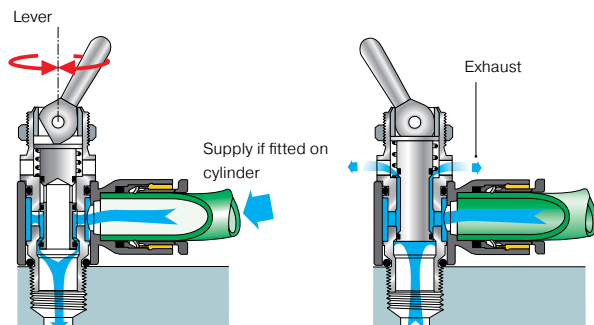

Supply if fitted on control valve

WARNING These products can expose you to chemicals including NICKEL or LEAD, which are known to the state of California to cause cancer, and LEAD which is known to cause birth defects or other reproductive harm. For more information go to www.P65Warnings.ca.gov.



[Click here for CADs, Product Specifications or to Configure Parts Online](#)

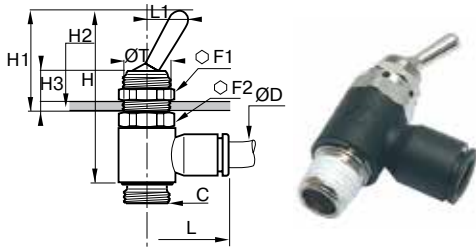

7805/7806 Manually Operated 3-Way Venting Valve Fractional Inch Tube to NPT

| PART NO. SUPPLY (1) | ØD IN | C NPT | F1 MM | F2 MM | H IN | H1 IN | H2 IN | H3 IN | L IN | L1 IN | ØT IN | W OZ |
|---------------------|-------|-------|-------|-------|------|-------|-------|-------|------|-------|-------|------|
| 7805 04 11 | 5/32 | 1/8 | 14 | 14 | 1.69 | .98 | .18 | .30 | .75 | .43 | .49 | .95 |
| 7805 56 11 | 1/4 | 1/8 | 14 | 14 | 1.69 | .98 | .18 | .30 | .85 | .43 | .49 | 1.02 |
| 7805 56 14 | 1/4 | 1/4 | 14 | 17 | 1.99 | .98 | .18 | .30 | .89 | .43 | .49 | 1.55 |
| 7805 60 14 | 3/8 | 1/4 | 14 | 17 | 1.99 | .98 | .18 | .30 | 1.14 | .43 | .49 | 1.69 |

| PART NO. SUPPLY (2) | ØD IN | C NPT | F1 MM | F2 MM | H IN | H1 IN | H2 IN | H3 IN | L IN | L1 IN | ØT IN | W OZ |
|---------------------|-------|-------|-------|-------|------|-------|-------|-------|------|-------|-------|------|
| 7806 04 11 | 5/32 | 1/8 | 14 | 14 | 1.69 | .98 | .18 | .30 | .75 | .43 | .49 | .95 |
| 7806 56 11 | 1/4 | 1/8 | 14 | 14 | 1.69 | .98 | .18 | .30 | .85 | .43 | .49 | 1.02 |
| 7806 56 14 | 1/4 | 1/4 | 14 | 17 | 1.99 | .98 | .18 | .30 | .89 | .43 | .49 | 1.55 |
| 7806 60 14 | 3/8 | 1/4 | 14 | 17 | 1.99 | .98 | .18 | .30 | 1.14 | .43 | .49 | 1.69 |

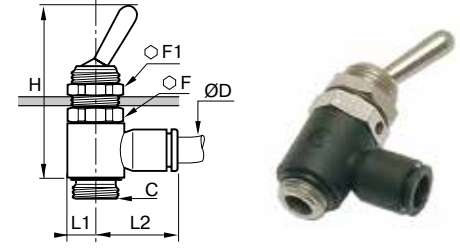

7800/7801 Manually Operated 3-Way Venting Valve Metric Tube to BSPP or Metric

| PART NO. SUPPLY (1) | ØD MM | C BSPP | F MM | F1 MM | H MM | L1 MM | L2 MM | W KG |
|---------------------|-------|--------|------|-------|------|-------|-------|------|
| 7800 04 19 | 4 | M5X0.8 | 8 | - | 32 | 5 | 16 | .020 |
| 7800 04 10 | 4 | G1/8 | 14 | 14 | 42.5 | 7 | 18.5 | .027 |
| 7800 06 19 | 6 | M5X0.8 | 8 | - | 32 | 5 | 19 | .022 |
| 7800 06 10 | 6 | G1/8 | 14 | 14 | 42.5 | 7 | 20 | .029 |
| 7800 06 13 | 6 | G1/4 | 17 | 17 | 51 | 9 | 22 | .044 |
| 7800 08 10 | 8 | G1/8 | 14 | 14 | 42.5 | 7 | 25 | .030 |
| 7800 08 13 | 8 | G1/4 | 17 | 17 | 51 | 9 | 27 | .045 |

| PART NO. SUPPLY (2) | ØD MM | C BSPP | F MM | F1 MM | H MM | L1 MM | L2 MM | W KG |
|---------------------|-------|--------|------|-------|------|-------|-------|------|
| 7801 04 19 | 4 | M5X0.8 | 8 | - | 32 | 5 | 16 | .020 |
| 7801 04 10 | 4 | G1/8 | 14 | 14 | 42.5 | 7 | 18.5 | .027 |
| 7801 06 19 | 6 | M5X0.8 | 8 | - | 32 | 5 | 19 | .022 |
| 7801 06 10 | 6 | G1/8 | 14 | 14 | 42.5 | 7 | 20 | .029 |
| 7801 06 13 | 6 | G1/4 | 17 | 17 | 51 | 9 | 22 | .044 |
| 7801 08 10 | 8 | G1/8 | 14 | 14 | 42.5 | 7 | 25 | .030 |

WARNING These products can expose you to chemicals including NICKEL or LEAD, which are known to the state of California to cause cancer, and LEAD which is known to cause birth defects or other reproductive harm. For more information go to www.P65Warnings.ca.gov.



A

B

C

D

E

F

G

H

I

J

K

L

M

N

O



Threshold Sensor Fittings

Parker's Threshold Sensor Fitting detects the pressure drop when a cylinder reaches the end of its stroke. They produce a pneumatic or electrical output signal when the pressure drop in the exhaust chamber of the cylinder goes below their back pressure threshold.

Product Features:

- Polymer body
- Brass screw
- NBR seal

Markets:

- Factory/Process Automation
- Packaging
- Pneumatics
- Semi-Conductor

Applications:

- Robotics
- Packaging
- Textile
- Machine Tools
- Pneumatic Systems

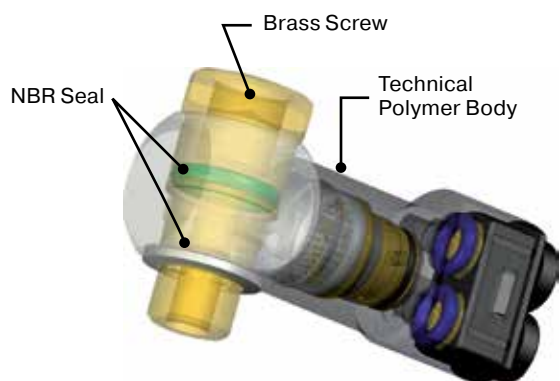

Specifications:

| | |
|--------------------------|---------------------------------|
| Model PSBJ,PSPJ | |
| Pressure Range | 45 to 115 PSI (3.1 to 7.9 bar) |
| Temperature Range | +5° to +140° F (-15° to +60° C) |
| Breaking Pressure | 8.5 PSI (0.5 bar) |
| Response Time | 3 MS |
| Model PSPE | |
| Pressure Range | 45 to 115 PSI (3.1 to 7.9 bar) |
| Breaking Pressure | 8.5 PSI (0.5 bar) |
| Current Rating | 5A/250VAC – 5W/48VDC |

Compatible Tubing:

- Semi-rigid nylon
- Polyurethane 95 Durometer Shore A
- Nylon
- Fluoropolymer

Operation

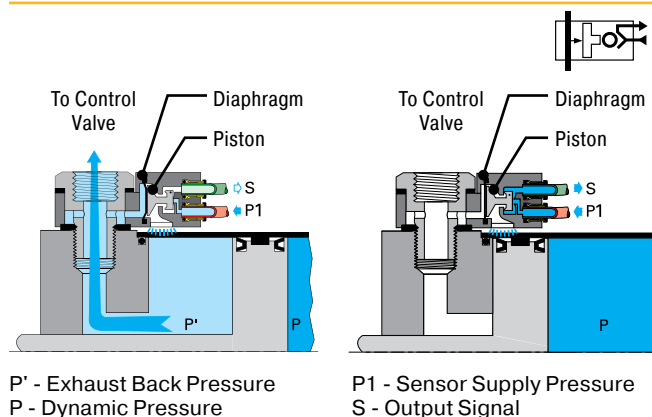

WARNING These products can expose you to chemicals including NICKEL or LEAD, which are known to the state of California to cause cancer, and LEAD which is known to cause birth defects or other reproductive harm. For more information go to www.P65Warnings.ca.gov.



Click here for CADs, Product Specifications or to Configure Parts Online

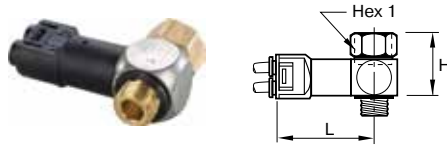

PSBJ731 Pneumatic Threshold Sensor - 5/32 Pilot

| PART NO. | NPT / UNF | HEX MM | H | L |
|-----------|-----------|--------|------|------|
| PSBJ731-0 | 10-32 | 5/16 | .62 | 1.70 |
| PSBJ731-2 | 1/8 | 9/16 | .90 | 1.74 |
| PSBJ731-4 | 1/4 | 5/8 | 1.09 | 1.81 |
| PSBJ731-6 | 3/8 | 7/8 | 1.13 | 1.91 |
| PSBJ731-8 | 1/2 | 1 | 1.17 | 2.05 |

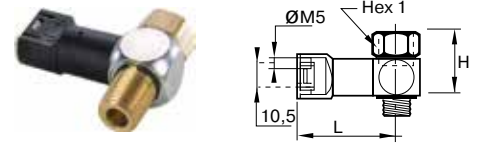

PSBJ708 Pneumatic Threshold Sensor - M5 Pilot

| PART NO. | BSPP | HEX 1 | H | L |
|------------|------|-------|----|------|
| PSBJ708-2G | 1/8 | 14 | 23 | 40.5 |
| PSBJ708-4G | 1/4 | 17 | 28 | 42.5 |

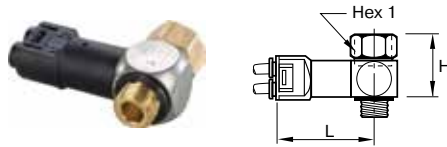

PSBJ731 Pneumatic Threshold Sensor - 4mm Pilot

| PART NO. | BSPP | HEX 1 | H | L |
|------------|--------|-------|----|------|
| PSBJ731-M5 | M5X0.8 | 8 | 16 | 43.5 |
| PSBJ731-2G | 1/8 | 14 | 23 | 44.5 |
| PSBJ731-4G | 1/4 | 17 | 28 | 46.5 |
| PSBJ731-6G | 3/8 | 22 | 29 | 49.0 |
| PSBJ731-8G | 1/2 | 27 | 30 | 52.5 |

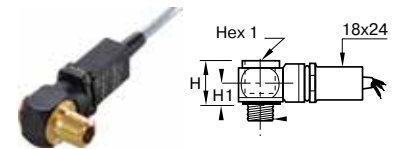

PSPE731 Pneumatic / Electric Threshold Sensor - BSPP

| PART NO. | BSPP | HEX 1 | H | H1 | L |
|------------|--------|-------|----|----|----|
| PSPE731-M5 | M5X0.8 | 8 | 20 | 10 | 49 |
| PSPE731-2G | 1/8 | 6 | 20 | 10 | 52 |
| PSPE731-4G | 1/4 | 8 | 20 | 10 | 54 |
| PSPE731-6G | 3/8 | 10 | 22 | 12 | 57 |

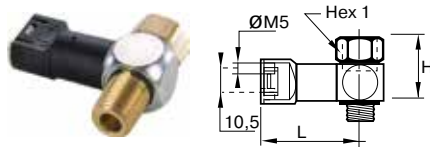

PSPJ731 Pneumatic Threshold Sensor - 10-32 Pilot

| PART NO. | NPT | HEX 1 MM | H | L |
|-----------|-----|----------|------|------|
| PSPJ731-2 | 1/8 | 9/16 | .90 | 1.58 |
| PSPJ731-4 | 1/4 | 5/8 | 1.09 | 1.66 |
| PSPJ731-6 | 3/8 | 7/8 | 1.13 | 1.76 |

WARNING These products can expose you to chemicals including NICKEL or LEAD, which are known to the state of California to cause cancer, and LEAD which is known to cause birth defects or other reproductive harm. For more information go to www.P65Warnings.ca.gov.



A

B

C

D

E

F

G

H

I

J

K

L

M

N

O



Mini Ball Valves

Parker's Mini Ball Valves enable in-line opening and closing of a pneumatic circuit. Handles are color coded and marked with the corresponding pneumatic symbol, in order to enable immediate identification by the user.

Product Features:

- Nylon body
- Brass stem
- Stainless steel gripping ring
- NBR stem seal
- NBR o-ring
- Nylon Handle
- Lightweight and compact

Markets:

- Factory/Process Automation
- Packaging
- Petrochemical
- Pneumatics
- Semi-Conductor

Applications:

- Robotics
- Packaging
- Textile
- Machine Tools
- Pneumatic Systems
- Vacuum

Specifications:

Pressure Range 145 PSI (9.9 bar)

Temperature Range -4° to 175° F (-20° to +79.4° C)

Vacuum Capability 28" Hg

Compatible Tubing:

- Semi-rigid nylon
- Polyurethane 95 Durometer Shore A
- Nylon
- Fluoropolymer

Operation

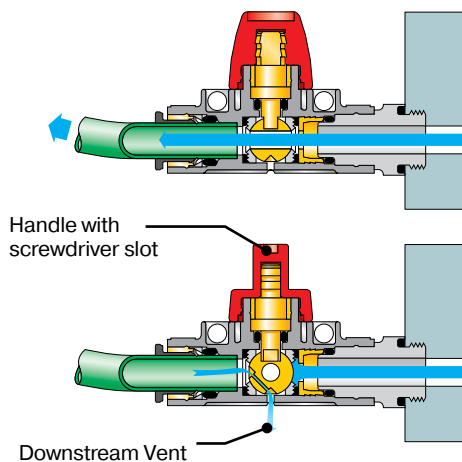

WARNING These products can expose you to chemicals including NICKEL or LEAD, which are known to the state of California to cause cancer, and LEAD which is known to cause birth defects or other reproductive harm. For more information go to www.P65Warnings.ca.gov.



[Click here for CADs, Product Specifications or to Configure Parts Online](#)

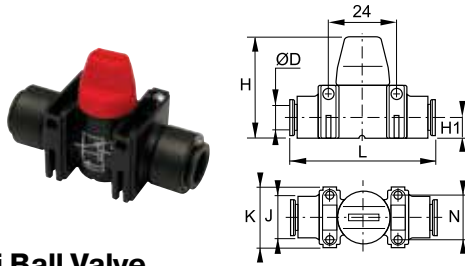

**MVV309 Mini Ball Valve
Vented Push-To-Connect Ports**

| PART NO. | TUBE SIZE IN | H | H1 | J | K | L | N |
|------------------|--------------|-------|-------|-------|-------|----|-------|
| METRIC | | | | | | | |
| MVV309-4M (5/32) | 4 | 37.00 | 7.50 | 15.00 | 22.00 | 51 | 16.20 |
| MVV309-6M | 6 | 37.00 | 7.50 | 15.00 | 22.00 | 52 | 16.20 |
| MVV309-8M (5/16) | 8 | 37.00 | 7.50 | 15.00 | 22.00 | 52 | 16.20 |
| MVV309-10M | 10 | 43.00 | 11.00 | 20.00 | 30.00 | 66 | 22.00 |
| MVV309-12M | 12 | 43.00 | 11.00 | 20.00 | 30.00 | 66 | 22.00 |

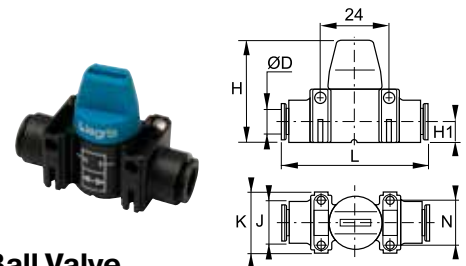

**MV309 Mini Ball Valve
Push-To-Connect Ports**

| PART NO. | TUBE SIZE IN | H | H1 | J | K | L | N |
|-----------------|--------------|-------|-------|-------|-------|-------|-------|
| METRIC | | | | | | | |
| MV309-4M (5/32) | 4 | 37.00 | 7.50 | 15.00 | 22.00 | 51.00 | 16.20 |
| MV309-6M | 6 | 37.00 | 7.50 | 15.00 | 22.00 | 52.00 | 16.20 |
| MV309-8M (5/16) | 8 | 37.00 | 7.50 | 15.00 | 22.00 | 52.00 | 16.20 |
| MV309-10M | 10 | 43.00 | 11.00 | 20.00 | 30.00 | 66.00 | 16.20 |
| MV309-12M | 12 | 43.00 | 11.00 | 20.00 | 30.00 | 66.00 | 16.20 |

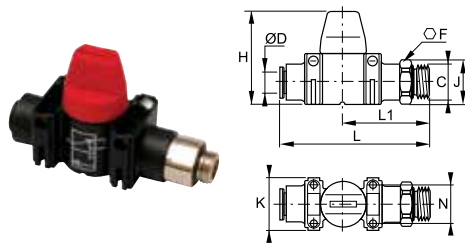

**MVV308 Mini Ball Valve
Vented BSPP to Push-To-Connect Port**

| PART NO. | TUBE SIZE MM | BSPP | F | H | J | K | L | L1 | N |
|---------------|--------------|------|----|----|-------|----|----|----|-------|
| MVV308-6M-2G | 6 | G1/8 | 13 | 37 | 14.00 | 22 | 62 | 37 | 16.20 |
| MVV308-8M-4G | 8 | G1/4 | 16 | 37 | 17.50 | 22 | 61 | 35 | 16.20 |
| MVV308-10M-6G | 10 | G3/8 | 20 | 43 | 22.00 | 30 | 74 | 41 | 22.00 |

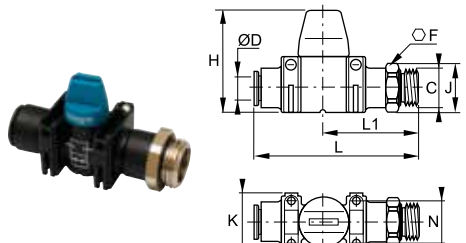

**MV308 Mini Ball Valve
BSPP to Push-To-Connect Port**

| PART NO. | TUBE SIZE MM | BSPP | F | H | J | K | L | L1 | N |
|--------------|--------------|------|----|----|----|----|----|----|-------|
| MV308-6M-2G | 6 | G1/8 | 13 | 37 | 14 | 22 | 62 | 37 | 16.20 |
| MV308-10M-6G | 10 | G3/8 | 20 | 43 | 22 | 30 | 74 | 41 | 16.20 |
| MV308-12M-8G | 12 | G1/2 | 24 | 43 | 26 | 30 | 75 | 42 | 16.20 |

WARNING These products can expose you to chemicals including NICKEL or LEAD, which are known to the state of California to cause cancer, and LEAD which is known to cause birth defects or other reproductive harm. For more information go to www.P65Warnings.ca.gov.



- A
- B
- C
- D
- E
- F
- G
- H
- I
- J
- K
- L
- M
- N
- O



Water & Beverage: Thermoplastic Fittings and Valves

LIQUIfit Fittings

TrueSeal™ Fittings

Fast & Tite® Fittings

Par-Barb® Fittings



For more product information visit:
www.parker.com/water







LIQUIfit Fittings

Parker's LIQUIfit Fittings offer an innovative alternative for water applications. These fittings ensure reliable and compact connection for liquid transfer applications.

Product Features:

- Stainless steel grab ring
- Bio-sourced nylon 11
- EPDM D – seal
- FDA compliant, NSF/ANSI 51 and NSF/ANSI 61
- Silicone free
- 100% leak tested in production
- Date coding to guarantee quality and traceability

Markets:

- Water Filtration
- Beverage Dispensing
- Life Science
- Bottling
- Semi-Conductor

Applications:

- Water
- Beverages
- Food
- CO₂
- Vacuum

Specifications:

Pressure Range Up to 230 PSI (16 bar)

Temperature Range +35° to +200° F (+1.7° to +93.3° C)

Note: The working specification depends on the type and wall thickness of the tube, the type of fluid, fluid Temperature and ambient temperature

Compatible Tubing:

- Polyethylene

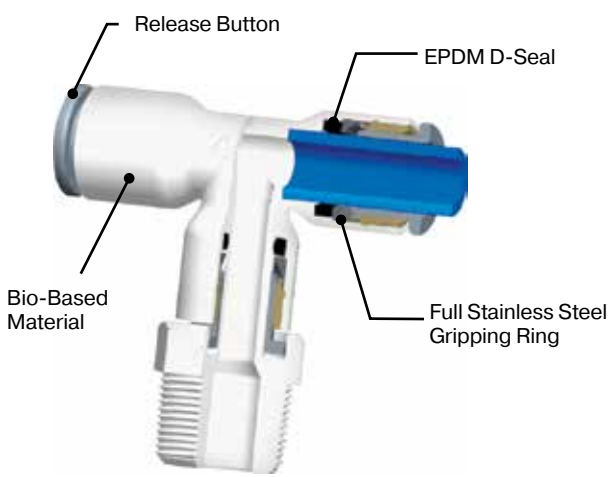

Assembly Instructions

1. Cut tubing squarely – maximum of 15° angle allowable.
2. Check that port or mating part is clean and free of debris.
3. Mark tubing to appropriate tube insertion length. (see Tube Insertion Chart on page N22)
4. Insert tubing until it bottoms
5. Pull on tubing to verify it is fully inserted
6. To disassemble, simply press release button, hold against body and pull tubing out of fitting.

WARNING These products can expose you to chemicals including CARBON BLACK, or LEAD, which are known to the state of California to cause cancer, and LEAD which is known to cause birth defects or other reproductive harm. For more information go to www.P65Warnings.ca.gov.

Threaded Fittings

6505

Male Connector
BSPT, NPTF
p. C7



6315

Female Connector
NPTF, BSPT
p. C7



6579

Male Elbow
NPTF, BSPT
p. C8



6325

Faucet Connector
UNS
p. C8



6521

Male Standpipe
NPTF, BSPT
p. C8



6509

Male Elbow Swivel
NPTF, BSPT
p. C8, C9



6508

Branch Tee Swivel
NPTF, BSPT
p. C9



AS

Angle Stop Fitting
p. C9



6503

Run Tee Swivel
NPTF, BSPT
p. C9, C10



6548

Male Y Connector
NPTF
p. C13



Tube to Tube Fittings

6306

Union
p. C10



6304

Union Tee
p. C10



6302

Union Elbow
p. C11



6340

Union Y
p. C11



6307

Cross
p. C13



Bulkhead Union

6316

Bulkhead Union
p. C7



Plug-In Fittings

6366

Tube Reducer
p. C11



6388

Plug-In Branch Tee
p. C12



6382

Plug-In Elbow
p. C12



6383

Plug-In Run Tee
p. C12, C13



6380

Plug-In 45° Elbow
p. C13



WARNING These products can expose you to chemicals including CARBON BLACK, or LEAD, which are known to the state of California to cause cancer, and LEAD which is known to cause birth defects or other reproductive harm. For more information go to www.P65Warnings.ca.gov.



- A
- B
- C
- D
- E
- F
- G
- H
- I
- J
- K
- L
- M
- N
- O

Ball Valves

VME
Male Elbow
p. C14



VUC
Union Connector
p. C14



VFE
Female Elbow
p. C15



VEU
Elbow Union
p. C15



VMC
Male Connector
p. C15



VFC
Female Connector
p. C15



VUCPB
Valve Union
Connector
p. C16



VAS
Valve Angle Stop
p. C16



BVC
Ball Valve Clip
p. C16



Accessories

6351
End Cap
p. C12



6326
Plug
p. C13



6322
Barbed Connector
p. C13



WARNING These products can expose you to chemicals including CARBON BLACK, or LEAD, which are known to the state of California to cause cancer, and LEAD which is known to cause birth defects or other reproductive harm. For more information go to www.P65Warnings.ca.gov.

Click here for CADs, Product Specifications or to Configure Parts Online

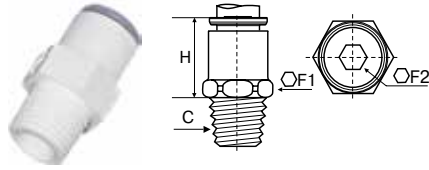

6505 Male Connector Inch Tube to NPTF

| PART NO. | TUBE SIZE IN | C NPTF | F1 | F2 | H |
|---------------|--------------|--------|-------|------|------|
| 6505 56 11WP2 | 1/4 | 1/8 | 1/2 | 5/32 | .67 |
| 6505 56 14WP2 | 1/4 | 1/4 | 9/16 | 5/32 | .67 |
| 6505 56 18WP2 | 1/4 | 3/8 | 3/4 | 1/4 | .85 |
| 6505 60 11WP2 | 3/8 | 1/8 | 3/4 | 5/32 | .87 |
| 6505 60 14WP2 | 3/8 | 1/4 | 3/4 | 1/4 | .87 |
| 6505 60 18WP2 | 3/8 | 3/8 | 3/4 | 1/4 | .87 |
| 6505 60 22WP2 | 3/8 | 1/2 | 15/16 | 1/4 | 1.06 |
| 6505 62 18WP2 | 1/2 | 3/8 | 15/16 | 3/8 | 1.10 |
| 6505 62 22WP2 | 1/2 | 1/2 | 15/16 | 3/8 | 1.10 |

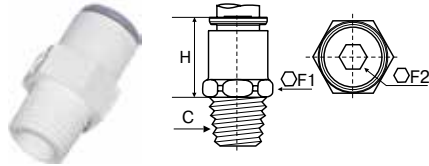

6505 Male Connector Metric Tube to BSPT

| PART NO. | TUBE SIZE MM | C BSPT | F1 | F2 | H |
|---------------|--------------|--------|----|----|-------|
| 6505 04 10WP2 | 4 | 1/8 | 11 | 3 | 18.00 |
| 6505 04 13WP2 | 4 | 1/4 | 14 | 3 | 18.00 |
| 6505 06 10WP2 | 6 | 1/8 | 11 | 4 | 18.00 |
| 6505 06 13WP2 | 6 | 1/4 | 14 | 4 | 18.00 |
| 6505 08 10WP2 | 8 | 1/8 | 17 | 6 | 20.00 |
| 6505 08 13WP2 | 8 | 1/4 | 17 | 6 | 20.00 |
| 6505 08 17WP2 | 8 | 3/8 | 17 | 6 | 20.00 |
| 6505 10 13WP2 | 10 | 1/4 | 17 | 7 | 21.50 |
| 6505 10 17WP2 | 10 | 3/8 | 19 | 7 | 21.50 |
| 6505 10 21WP2 | 10 | 1/2 | 22 | 7 | 21.50 |
| 6505 12 17WP2 | 12 | 3/8 | 19 | 9 | 24.50 |
| 6505 12 21WP2 | 12 | 1/2 | 22 | 9 | 24.50 |

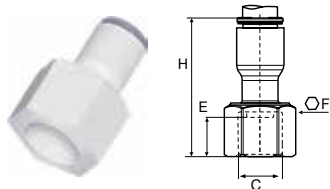

6315 Female Connector Inch Tube to NPTF

| PART NO. | TUBE SIZE IN | C NPTF | E | F | H |
|---------------|--------------|--------|----|-------|------|
| 6315 56 14WP2 | 1/4 | 1/4 | 14 | 11/16 | 1.18 |
| 6315 60 18WP2 | 3/8 | 3/8 | 14 | 3/16 | 1.42 |

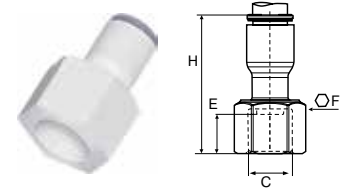

6315 Female Connector Metric Tube to BSPT

| PART NO. | TUBE SIZE MM | C BSPT | E | F | H |
|---------------|--------------|--------|----|----|-------|
| 6315 06 10WP2 | 6 | 1/8 | 11 | 13 | 32.00 |
| 6315 06 13WP2 | 6 | 1/4 | 14 | 16 | 33.00 |
| 6315 08 13WP2 | 8 | 1/4 | 14 | 16 | 33.50 |
| 6315 08 17WP2 | 8 | 3/8 | 14 | 20 | 36.00 |

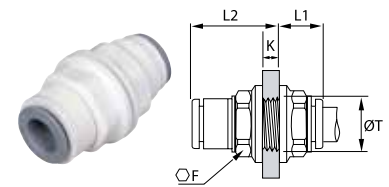

6316 Bulkhead Union Inch Tube

| PART NO. | TUBE SIZE IN | F | K MAX | L1 | L2 | T MIN |
|---------------|--------------|------|-------|-----|------|-------|
| 6316 04 00WP2 | 5/32 | .51 | .22 | .41 | .61 | .41 |
| 6316 56 00WP2 | 1/4 | .59 | .33 | .39 | .79 | .49 |
| 6316 08 00WP2 | 5/16 | .71 | .57 | .41 | 1.06 | .61 |
| 6316 60 00WP2 | 3/8 | .87 | .57 | .49 | 1.16 | .73 |
| 6316 62 00WP2 | 1/2 | 1.41 | .81 | .67 | 1.59 | 1.00 |

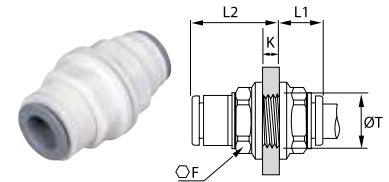

6316 Bulkhead Union Metric Tube

| PART NO. | TUBE SIZE MM | F | K MAX | L1 | L2 | T MIN |
|---------------|--------------|----|-------|-------|-------|-------|
| 6316 04 00WP2 | 4 | 13 | 5.50 | 10.50 | 15.50 | 10.50 |
| 6316 06 00WP2 | 6 | 15 | 8.50 | 10.00 | 20.00 | 12.50 |
| 6316 08 00WP2 | 8 | 18 | 14.50 | 10.50 | 27.00 | 15.50 |
| 6316 10 00WP2 | 10 | 22 | 14.50 | 13.00 | 30.00 | 18.50 |
| 6316 12 00WP2 | 12 | 26 | 18.50 | 15.50 | 35.00 | 22.50 |

WARNING These products can expose you to chemicals including CARBON BLACK, or LEAD, which are known to the state of California to cause cancer, and LEAD which is known to cause birth defects or other reproductive harm. For more information go to www.P65Warnings.ca.gov.

- A
- B
- C
- D
- E
- F
- G
- H
- I
- J
- K
- L
- M
- N
- O

Click here for CADs, Product Specifications or to Configure Parts Online

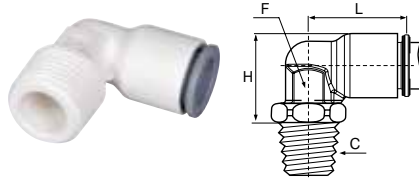

6579 Fixed Elbow Inch Tube to NPTF

| PART NO. | TUBE SIZE IN | C NPTF | F | H | L |
|---------------|--------------|--------|-----|-----|------|
| 6579 56 11WP2 | 1/4 | 1/8 | 3/8 | .54 | .71 |
| 6579 56 14WP2 | 1/4 | 1/4 | 3/8 | .54 | .71 |
| 6579 56 18WP2 | 1/4 | 3/8 | 3/8 | .54 | .71 |
| 6579 60 14WP2 | 3/8 | 1/4 | 1/2 | .77 | 1.02 |
| 6579 60 18WP2 | 3/8 | 3/8 | 1/2 | .77 | 1.02 |

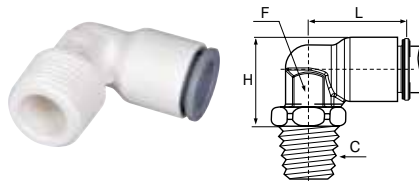

6579 Fixed Elbow Metric Tube to BSPT

| PART NO. | TUBE SIZE MM | C BSPT | F | H | L |
|---------------|--------------|--------|----|----|----|
| 6579 06 10WP2 | 6 | 1/8 | 10 | 14 | 19 |
| 6579 06 13WP2 | 6 | 1/4 | 10 | 14 | 19 |
| 6579 06 17WP2 | 6 | 3/8 | 10 | 14 | 19 |

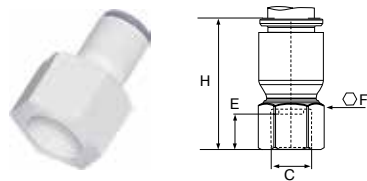

6325 Faucet Connector Inch Tube to UNS

| PART NO. | TUBE SIZE IN | C UNS | E | F | H |
|----------------|--------------|---------|----|------|------|
| 6325 56 133WP2 | 1/4 | 7/16-24 | 27 | 9/16 | 1.22 |
| 6325 60 133WP2 | 3/8 | 7/16-24 | 27 | 9/16 | 1.26 |

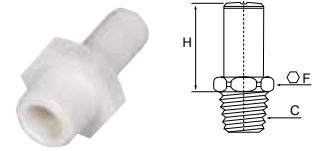

6521 Stem Adapter Inch Tube to NPTF

| PART NO. | TUBE SIZE IN | C NPTF | F | H |
|---------------|--------------|--------|-------|------|
| 6521 56 11WP2 | 1/4 | 1/8 | 1/2 | .75 |
| 6521 56 14WP2 | 1/4 | 1/4 | 1/2 | .75 |
| 6521 56 18WP2 | 1/4 | 3/8 | 3/4 | .77 |
| 6521 60 14WP2 | 3/8 | 1/4 | 3/4 | .98 |
| 6521 60 18WP2 | 3/8 | 3/8 | 3/4 | .98 |
| 6521 62 18WP2 | 1/2 | 3/8 | 15/16 | 1.22 |
| 6521 62 22WP2 | 1/2 | 1/2 | 15/16 | 1.28 |

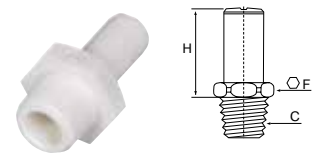

6521 Stem Adapter Metric Tube to BSPT

| PART NO. | TUBE SIZE MM | C BSPT | F | H |
|---------------|--------------|--------|----|----|
| 6521 06 10WP2 | 6 | 1/8 | 13 | 19 |
| 6521 06 13WP2 | 6 | 1/4 | 14 | 19 |
| 6521 06 17WP2 | 6 | 3/8 | 17 | 19 |
| 6521 08 10WP2 | 8 | 1/8 | 19 | 23 |
| 6521 08 13WP2 | 8 | 1/4 | 19 | 23 |
| 6521 08 17WP2 | 8 | 3/8 | 19 | 23 |
| 6521 10 13WP2 | 10 | 1/4 | 19 | 25 |
| 6521 10 17WP2 | 10 | 3/8 | 19 | 25 |
| 6521 10 21WP2 | 10 | 1/2 | 22 | 25 |
| 6521 12 17WP2 | 12 | 3/8 | 22 | 28 |
| 6521 12 21WP2 | 12 | 1/2 | 22 | 28 |



6509 Swivel Elbow Inch Tube to NPTF

| PART NO. | TUBE SIZE IN | C NPTF | F | H | L |
|---------------|--------------|--------|-------|------|------|
| 6509 56 11WP2 | 1/4 | 1/8 | 1/2 | 1.10 | .93 |
| 6509 56 14WP2 | 1/4 | 1/4 | 9/16 | 1.10 | .93 |
| 6509 56 18WP2 | 1/4 | 3/8 | 3/4 | 1.12 | .93 |
| 6509 60 14WP2 | 3/8 | 1/4 | 3/4 | 1.50 | 1.34 |
| 6509 60 18WP2 | 3/8 | 3/8 | 3/4 | 1.50 | 1.34 |
| 6509 62 18WP2 | 1/2 | 3/8 | 15/16 | 1.99 | 1.83 |
| 6509 62 22WP2 | 1/2 | 1/2 | 15/16 | 1.99 | 1.83 |

WARNING These products can expose you to chemicals including CARBON BLACK, or LEAD, which are known to the state of California to cause cancer, and LEAD which is known to cause birth defects or other reproductive harm. For more information go to www.P65Warnings.ca.gov.



Click here for CADs, Product Specifications or to Configure Parts Online

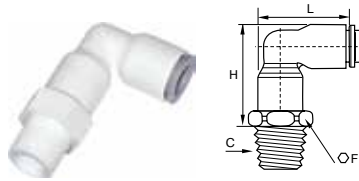

6509 Swivel Elbow Metric Tube to BSPT

| PART NO. | TUBE SIZE MM | C BSPT | F | H | L |
|---------------|--------------|--------|----|----|-------|
| 6509 06 10WP2 | 6 | 1/8 | 13 | 28 | 24.00 |
| 6509 06 13WP2 | 6 | 1/4 | 14 | 28 | 24.00 |
| 6509 06 17WP2 | 6 | 3/8 | 17 | 28 | 24.00 |
| 6509 08 10WP2 | 8 | 1/8 | 19 | 34 | 29.50 |
| 6509 08 13WP2 | 8 | 1/4 | 19 | 34 | 29.50 |
| 6509 08 17WP2 | 8 | 3/8 | 19 | 34 | 29.50 |
| 6509 10 13WP2 | 10 | 1/4 | 19 | 38 | 34.50 |
| 6509 10 17WP2 | 10 | 3/8 | 19 | 38 | 34.50 |
| 6509 10 21WP2 | 10 | 1/2 | 22 | 38 | 34.50 |
| 6509 12 17WP2 | 12 | 3/8 | 22 | 44 | 40.00 |
| 6509 12 21WP2 | 12 | 1/2 | 22 | 44 | 40.00 |

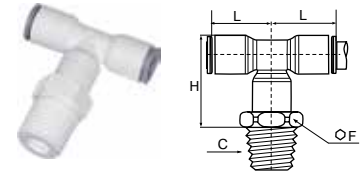

6508 Swivel Branch Tee Metric Tube to BSPT

| PART NO. | TUBE SIZE MM | C BSPT | F | H | L |
|---------------|--------------|--------|----|-------|-------|
| 6508 06 10WP2 | 6 | 1/8 | 13 | 28.00 | 18.00 |
| 6508 06 13WP2 | 6 | 1/4 | 14 | 28.00 | 18.00 |
| 6508 06 17WP2 | 6 | 3/8 | 17 | 28.00 | 18.00 |
| 6508 08 10WP2 | 8 | 1/8 | 19 | 34.00 | 23.00 |
| 6508 08 13WP2 | 8 | 1/4 | 19 | 34.00 | 23.00 |
| 6508 08 17WP2 | 8 | 3/8 | 19 | 34.00 | 23.00 |
| 6508 10 13WP2 | 10 | 1/4 | 19 | 38.00 | 26.50 |
| 6508 10 17WP2 | 10 | 3/8 | 19 | 38.00 | 26.50 |
| 6508 10 21WP2 | 10 | 1/2 | 22 | 38.00 | 26.50 |
| 6508 12 17WP2 | 12 | 3/8 | 22 | 44.00 | 31.00 |
| 6508 12 21WP2 | 12 | 1/2 | 22 | 44.00 | 31.00 |

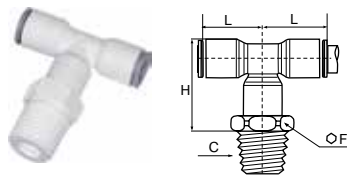

6508 Swivel Branch Tee Inch Tube to NPTF

| PART NO. | TUBE SIZE IN | C NPTF | F | H | L |
|---------------|--------------|--------|-------|------|------|
| 6508 56 11WP2 | 1/4 | 1/8 | 1/2 | 1.10 | .71 |
| 6508 56 14WP2 | 1/4 | 1/4 | 9/16 | 1.10 | .71 |
| 6508 56 18WP2 | 1/4 | 3/8 | 3/4 | 1.10 | .71 |
| 6508 60 14WP2 | 3/8 | 1/4 | 3/4 | 1.50 | 1.02 |
| 6508 60 18WP2 | 3/8 | 3/8 | 3/4 | 1.50 | 1.02 |
| 6508 62 18WP2 | 1/2 | 3/8 | 15/16 | 1.97 | 1.40 |
| 6508 62 22WP2 | 1/2 | 1/2 | 15/16 | 2.00 | 1.40 |

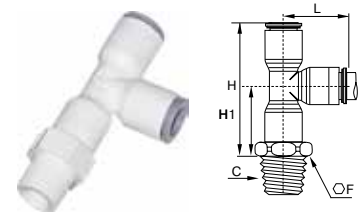

6503 Swivel Run Tee Inch Tube to NPTF

| PART NO. | TUBE SIZE IN | C NPTF | F | H | H1 | L |
|---------------|--------------|--------|-------|------|------|------|
| 6503 56 11WP2 | 1/4 | 1/8 | 1/2 | 1.60 | .88 | .71 |
| 6503 56 14WP2 | 1/4 | 1/4 | 9/16 | 1.60 | .88 | .71 |
| 6503 56 18WP2 | 1/4 | 3/8 | 3/4 | 1.63 | .90 | .71 |
| 6503 60 14WP2 | 3/8 | 1/4 | 3/4 | 1.63 | 1.18 | 1.02 |
| 6503 60 18WP2 | 3/8 | 3/8 | 3/4 | 1.63 | 1.18 | 1.02 |
| 6503 62 18WP2 | 1/2 | 3/8 | 15/16 | 2.29 | 1.55 | 1.40 |
| 6503 62 22WP2 | 1/2 | 1/2 | 15/16 | 2.99 | 1.59 | 1.40 |

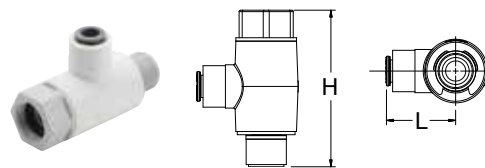

AS Angle Stop Fitting

| PART NO. | TUBE SIZE IN | MALE THD. | FEMALE THD. | UNEF THD. | H | L |
|----------|--------------|-----------|-------------|-----------|------|-----|
| LFPP4AS6 | 1/4 | 3/8 | 3/8 | 9/16-24 | 2.17 | .96 |

WARNING These products can expose you to chemicals including CARBON BLACK, or LEAD, which are known to the state of California to cause cancer, and LEAD which is known to cause birth defects or other reproductive harm. For more information go to www.P65Warnings.ca.gov.



- A
- B
- C
- D
- E
- F
- G
- H
- I
- J
- K
- L
- M
- N
- O

[Click here for CADs, Product Specifications or to Configure Parts Online](#)

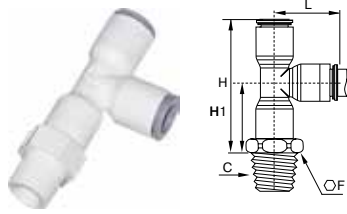

6503 Swivel Run Tee Metric Tube to BSPT

| PART NO. | TUBE SIZE MM | C BSPT | F | H | H1 | L |
|---------------|--------------|--------|----|-------|-------|-------|
| 6503 06 13WP2 | 6 | 1/4 | 14 | 40.00 | 22.00 | 18.50 |
| 6503 08 10WP2 | 8 | 1/8 | 19 | 50.00 | 27.00 | 23.00 |
| 6503 08 13WP2 | 8 | 1/4 | 19 | 50.00 | 27.00 | 23.00 |
| 6503 08 17WP2 | 8 | 3/8 | 19 | 50.00 | 27.00 | 23.00 |
| 6503 12 17WP2 | 12 | 3/8 | 22 | 65.50 | 34.50 | 31.00 |
| 6503 12 21WP2 | 12 | 1/2 | 22 | 65.50 | 34.50 | 31.00 |

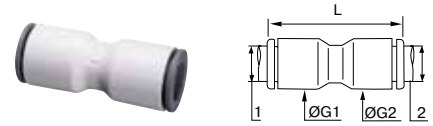

6306 Union Connector Metric Tube

| PART NO. | TUBE 1 SIZE MM | TUBE 2 SIZE MM | G1 | G2 | L |
|---------------|----------------|----------------|-------|-------|-------|
| 6306 04 00WP2 | 4 | 4 | 8.50 | 8.50 | 26.50 |
| 6306 06 00WP2 | 6 | 6 | 10.50 | 10.50 | 30.00 |
| 6306 08 00WP2 | 8 | 8 | 13.50 | 13.50 | 37.00 |
| 6306 10 00WP2 | 10 | 10 | 16.00 | 16.00 | 42.00 |
| 6306 12 00WP2 | 12 | 12 | 19.00 | 19.00 | 50.50 |
| 6306 04 06WP2 | 4 | 6 | 8.50 | 10.50 | 29.00 |
| 6306 04 08WP2 | 4 | 8 | 13.50 | 13.50 | 37.00 |
| 6306 06 08WP2 | 6 | 8 | 13.50 | 13.50 | 37.00 |
| 6306 06 10WP2 | 6 | 10 | 16.00 | 16.00 | 42.00 |
| 6306 08 10WP2 | 8 | 10 | 16.00 | 16.00 | 42.00 |
| 6306 08 12WP2 | 8 | 12 | 19.00 | 19.00 | 50.00 |
| 6306 10 12WP2 | 10 | 12 | 19.00 | 19.00 | 50.00 |

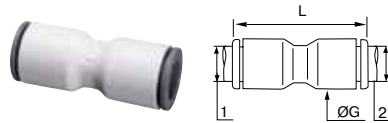

6306 Union Connector Inch Tube

| PART NO. | TUBE 1 SIZE IN | TUBE 2 SIZE IN | G | L |
|---------------|----------------|----------------|-----|------|
| 6306 56 00WP2 | 1/4 | 1/4 | .43 | 1.18 |
| 6306 08 00WP2 | 5/16 | 5/16 | .53 | 1.46 |
| 6306 60 00WP2 | 3/8 | 3/8 | .63 | 1.65 |
| 6306 62 00WP2 | 1/2 | 1/2 | .87 | 2.24 |
| 6306 56 60WP2 | 1/4 | 3/8 | .63 | 1.61 |
| 6306 56 08WP2 | 1/4 | 5/16 | .53 | 1.46 |
| 6306 08 60WP2 | 5/16 | 3/8 | .63 | 1.65 |
| 6306 08 62WP2 | 5/16 | 1/2 | .87 | 2.16 |
| 6306 60 62WP2 | 3/8 | 1/2 | .87 | 2.20 |

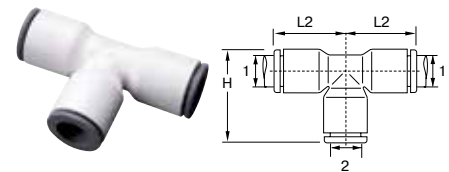

6304 Union Tee Inch Tube

| PART NO. | TUBE 1 SIZE IN | TUBE 2 SIZE IN | H | L2 |
|---------------|----------------|----------------|------|------|
| 6304 04 00WP2 | 5/32 | 5/32 | .79 | .61 |
| 6304 56 00WP2 | 1/4 | 1/4 | .94 | .71 |
| 6304 08 00WP2 | 5/16 | 5/16 | 1.14 | .89 |
| 6304 60 00WP2 | 3/8 | 3/8 | 1.34 | 1.02 |
| 6304 62 00WP2 | 1/2 | 1/2 | 1.85 | 1.42 |
| 6304 60 56WP2 | 3/8 | 1/4 | 1.34 | 1.02 |
| 6304 62 60WP2 | 1/2 | 3/8 | 1.85 | 1.42 |

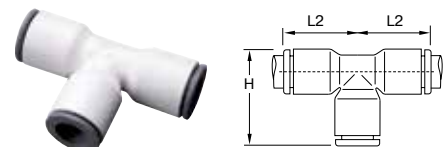

6304 Union Tee Metric Tube

| PART NO. | TUBE SIZE MM | H | L2 |
|---------------|--------------|-------|-------|
| 6304 04 00WP2 | 4 | 20.00 | 15.50 |
| 6304 06 00WP2 | 6 | 23.00 | 18.00 |
| 6304 08 00WP2 | 8 | 29.00 | 22.50 |
| 6304 10 00WP2 | 10 | 34.50 | 26.50 |
| 6304 12 00WP2 | 12 | 40.00 | 31.00 |

WARNING These products can expose you to chemicals including CARBON BLACK, or LEAD, which are known to the state of California to cause cancer, and LEAD which is known to cause birth defects or other reproductive harm. For more information go to www.P65Warnings.ca.gov.



[Click here for CADs, Product Specifications or to Configure Parts Online](#)

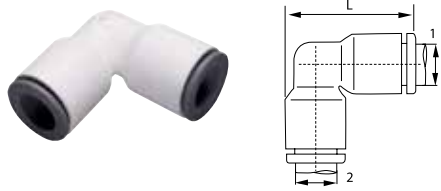

6302 Union Elbow Inch Tube

| PART NO. | TUBE 1 SIZE IN | TUBE 2 SIZE IN | L |
|---------------|----------------|----------------|------|
| 6302 04 00WP2 | 5/32 | 5/32 | .75 |
| 6302 56 00WP2 | 1/4 | 1/4 | .94 |
| 6302 08 00WP2 | 5/16 | 5/16 | 1.16 |
| 6302 60 00WP2 | 3/8 | 3/8 | 1.34 |
| 6302 62 00WP2 | 1/2 | 1/2 | 1.83 |
| 6302 56 08WP2 | 1/4 | 5/16 | 1.16 |
| 6302 08 60WP2 | 5/16 | 3/8 | 1.34 |
| 6302 56 60WP2 | 3/8 | 1/4 | 1.30 |
| 6302 60 62WP2 | 3/8 | 1/2 | 1.83 |

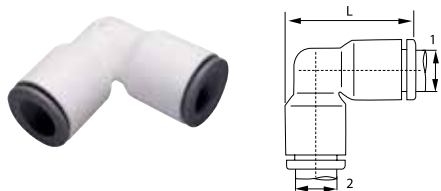

6302 Union Elbow Metric Tube

| PART NO. | TUBE 1 SIZE MM | TUBE 2 SIZE MM | L |
|---------------|----------------|----------------|-------|
| 6302 04 00WP2 | 4 | 4 | 19.50 |
| 6302 06 00WP2 | 6 | 6 | 24.00 |
| 6302 08 00WP2 | 8 | 8 | 29.50 |
| 6302 10 00WP2 | 10 | 10 | 34.50 |
| 6302 12 00WP2 | 12 | 12 | 40.50 |
| 6302 04 06WP2 | 4 | 6 | 24.00 |
| 6302 06 08WP2 | 6 | 8 | 29.50 |
| 6302 08 10WP2 | 8 | 10 | 34.50 |
| 6302 10 12WP2 | 10 | 12 | 40.50 |

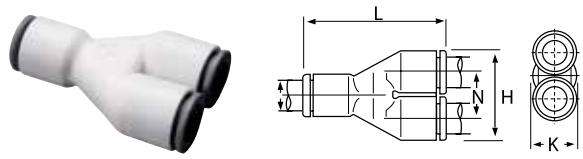

6340 Union Y Connector Inch Tube

| PART NO. | TUBE SIZE IN | H | K | L | N |
|---------------|--------------|------|-----|------|-----|
| 6340 04 00WP2 | 5/32 | .69 | .33 | 1.18 | .35 |
| 6340 56 00WP2 | 1/4 | .87 | .43 | 1.42 | .45 |
| 6340 08 00WP2 | 5/16 | 1.10 | .53 | 1.75 | .57 |
| 6340 60 00WP2 | 3/8 | 1.30 | .63 | 2.08 | .67 |
| 6340 62 00WP2 | 1/2 | 1.77 | .87 | 2.64 | .91 |

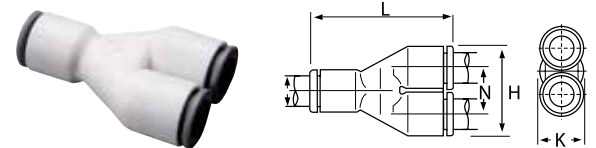

6340 Union Y Connector Metric Tube

| PART NO. | TUBE SIZE MM | H | K | L | N |
|---------------|--------------|-------|-------|-------|-------|
| 6340 04 00WP2 | 4 | 17.50 | 8.50 | 30.00 | 9.00 |
| 6340 06 00WP2 | 6 | 21.50 | 10.50 | 36.50 | 11.00 |
| 6340 08 00WP2 | 8 | 28.00 | 13.50 | 44.50 | 14.50 |
| 6340 10 00WP2 | 10 | 33.00 | 16.00 | 53.00 | 17.00 |
| 6340 12 00WP2 | 12 | 39.00 | 19.00 | 60.50 | 20.00 |

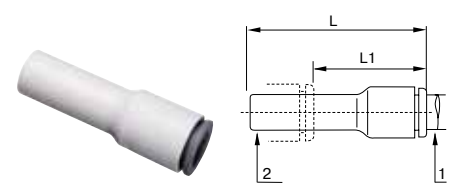

6366 Reducer Inch Tube to Stem

| PART NO. | TUBE 1 SIZE IN | TUBE 2 SIZE IN | L | L1 |
|---------------|----------------|----------------|------|------|
| 6366 56 08WP2 | 1/4 | 5/16 | 1.61 | .89 |
| 6366 56 60WP2 | 1/4 | 3/8 | 1.61 | .81 |
| 6366 08 60WP2 | 5/16 | 3/8 | 1.91 | 1.14 |
| 6366 08 62WP2 | 5/16 | 1/2 | 1.91 | .87 |
| 6366 60 62WP2 | 3/8 | 1/2 | 2.01 | 1.18 |

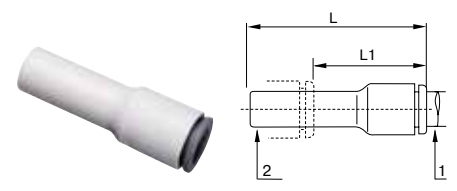

6366 Reducer Metric Tube to Stem

| PART NO. | TUBE 1 SIZE MM | TUBE 2 SIZE MM | L | L1 |
|---------------|----------------|----------------|-------|-------|
| 6366 04 06WP2 | 4 | 6 | 38.00 | 23.50 |
| 6366 04 08WP2 | 4 | 8 | 38.00 | 19.00 |
| 6366 06 08WP2 | 6 | 8 | 38.00 | 20.00 |
| 6366 06 10WP2 | 6 | 10 | 39.00 | 17.50 |
| 6366 08 10WP2 | 8 | 10 | 48.50 | 28.50 |
| 6366 08 12WP2 | 8 | 12 | 48.50 | 24.50 |
| 6366 10 12WP2 | 10 | 12 | 52.00 | 33.50 |
| 6366 10 14WP2 | 10 | 14 | 53.00 | 33.50 |
| 6366 12 14WP2 | 12 | 14 | 55.50 | 33.50 |

WARNING These products can expose you to chemicals including CARBON BLACK, or LEAD, which are known to the state of California to cause cancer, and LEAD which is known to cause birth defects or other reproductive harm. For more information go to www.P65Warnings.ca.gov.



[Click here for CADs, Product Specifications or to Configure Parts Online](#)

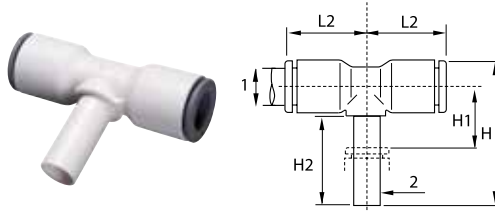

6388 Plug-In Tee Inch Tube to Stem

| PART NO. | TUBE 1 SIZE IN | TUBE 2 SIZE IN | H | H1 | H2 | L2 |
|---------------|----------------|----------------|------|-----|------|------|
| 6388 56 00WP2 | 1/4 | 1/4 | 1.20 | .43 | .79 | .71 |
| 6388 08 00WP2 | 5/16 | 5/16 | 1.32 | .31 | .85 | .90 |
| 6388 60 00WP2 | 3/8 | 3/8 | 1.65 | .49 | .98 | .98 |
| 6388 62 00WP2 | 1/2 | 1/2 | 2.01 | .51 | 1.14 | 1.26 |

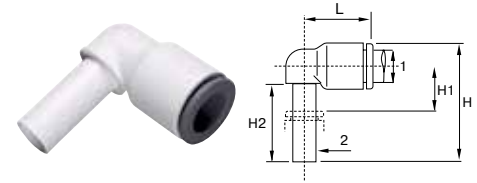

6382 Plug-In Elbow Inch Tube to Stem

| PART NO. | TUBE 1 SIZE IN | TUBE 2 SIZE IN | H | H1 | H2 | L |
|---------------|----------------|----------------|------|-----|------|------|
| 6382 56 00WP2 | 1/4 | 1/4 | 1.20 | .43 | .71 | .71 |
| 6382 08 00WP2 | 5/16 | 5/16 | 1.32 | .31 | .85 | .88 |
| 6382 60 00WP2 | 3/8 | 3/8 | 1.53 | .35 | .96 | 1.04 |
| 6382 56 60WP2 | 1/4 | 3/8 | 1.93 | .51 | 1.12 | 1.42 |
| 6382 60 56WP2 | 3/8 | 1/4 | 1.26 | .43 | .71 | 1.04 |

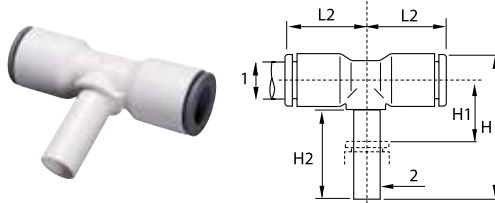

6388 Plug-In Tee Metric Tube to Stem

| PART NO. | TUBE 1 SIZE MM | TUBE 2 SIZE MM | H | H1 | H2 | L2 |
|---------------|----------------|----------------|-------|------|-------|-------|
| 6388 04 00WP2 | 4 | 4 | 25.00 | 6.00 | 15.50 | 15.00 |
| 6388 06 00WP2 | 6 | 6 | 28.50 | 7.00 | 17.00 | 16.00 |
| 6388 08 00WP2 | 8 | 8 | 33.50 | 8.00 | 21.50 | 23.00 |
| 6388 10 00WP2 | 10 | 10 | 41.00 | 9.50 | 24.50 | 26.50 |

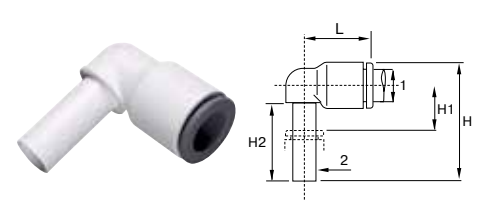

6382 Plug-In Elbow Metric Tube to Stem

| PART NO. | TUBE 1 SIZE MM | TUBE 2 SIZE MM | H | H1 | H2 | L |
|---------------|----------------|----------------|-------|-------|-------|-------|
| 6382 04 00WP2 | 4 | 4 | 23.00 | 6.00 | 15.50 | 15.00 |
| 6382 06 00WP2 | 6 | 6 | 26.50 | 7.00 | 17.00 | 17.00 |
| 6382 08 00WP2 | 8 | 8 | 33.00 | 8.00 | 21.50 | 22.50 |
| 6382 10 00WP2 | 10 | 10 | 39.00 | 9.50 | 24.50 | 26.50 |
| 6382 12 00WP2 | 12 | 12 | 44.50 | 10.00 | 27.00 | 31.00 |
| 6382 04 06WP2 | 4 | 6 | 26.50 | 7.00 | 17.00 | 16.50 |
| 6382 06 04WP2 | 6 | 4 | 25.00 | 7.00 | 15.50 | 17.00 |
| 6382 06 08WP2 | 6 | 8 | 33.50 | 8.00 | 21.50 | 22.50 |
| 6382 08 10WP2 | 8 | 10 | 39.00 | 9.50 | 24.50 | 26.00 |
| 6382 10 12WP2 | 10 | 12 | 44.50 | 10.00 | 27.00 | 30.00 |

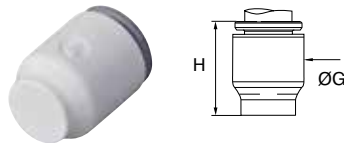

6351 End Stop Inch Tube

| PART NO. | TUBE SIZE IN | G | H |
|---------------|--------------|-----|-----|
| 6351 04 00WP2 | 5/32 | .33 | .59 |
| 6351 56 00WP2 | 1/4 | .43 | .63 |
| 6351 08 00WP2 | 5/16 | .53 | .85 |
| 6351 60 00WP2 | 3/8 | .63 | .88 |

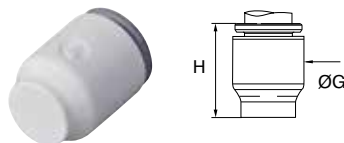

6351 End Stop Metric Tube

| PART NO. | TUBE SIZE MM | G | H |
|---------------|--------------|-------|-------|
| 6351 04 00WP2 | 4 | 8.50 | 15.00 |
| 6351 06 00WP2 | 6 | 10.50 | 17.00 |
| 6351 08 00WP2 | 8 | 13.50 | 21.50 |
| 6351 10 00WP2 | 10 | 16.00 | 22.00 |
| 6351 12 00WP2 | 12 | 19.00 | 27.50 |

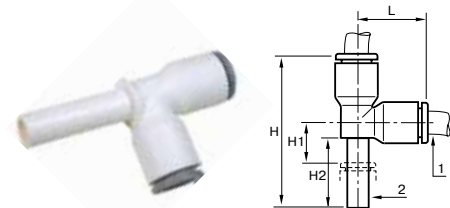

6383 Plug-In Run Tee Inch Tube to Stem

| PART NO. | TUBE 1 SIZE IN | TUBE 2 SIZE IN | H | H1 | H2 | L |
|---------------|----------------|----------------|------|-----|------|------|
| 6383 56 00WP2 | 1/4 | 1/4 | 1.20 | .43 | .71 | .71 |
| 6383 60 00WP2 | 3/8 | 3/8 | 2.24 | .43 | .96 | 1.04 |
| 6383 62 00WP2 | 1/2 | 1/2 | 1.93 | .71 | 1.12 | 1.42 |

WARNING These products can expose you to chemicals including CARBON BLACK, or LEAD, which are known to the state of California to cause cancer, and LEAD which is known to cause birth defects or other reproductive harm. For more information go to www.P65Warnings.ca.gov.



Click here for CADs, Product Specifications or to Configure Parts Online

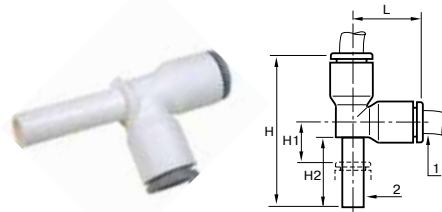

6383 Plug-In Run Tee Metric Tube to Stem

| PART NO. | TUBE 1 SIZE MM | TUBE 2 SIZE MM | H | H1 | H2 | L |
|---------------|----------------|----------------|-------|-------|-------|-------|
| 6383 04 00WP2 | 4 | 4 | 33.00 | 6.00 | 15.50 | 15.00 |
| 6383 06 00WP2 | 6 | 6 | 38.50 | 7.00 | 17.00 | 18.00 |
| 6383 08 00WP2 | 8 | 8 | 49.00 | 8.00 | 21.50 | 23.00 |
| 6383 10 00WP2 | 10 | 10 | 57.00 | 10.50 | 25.50 | 26.50 |

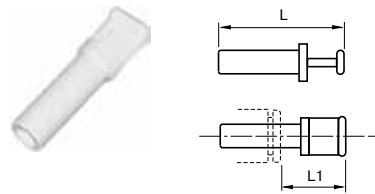

6326 Plug Inch

| PART NUMBER | STEM SIZE IN | L | L1 |
|---------------|--------------|------|-----|
| 6326 56 00WP2 | 1/4 | 1.44 | .87 |
| 6326 08 00WP2 | 5/16 | 1.38 | .69 |
| 6326 60 00WP2 | 3/8 | 1.67 | .87 |
| 6326 62 00WP2 | 1/2 | 1.91 | .85 |

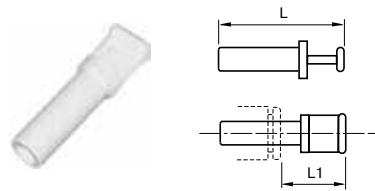

6326 Plug Metric

| PART NUMBER | STEM SIZE MM | L | L1 |
|---------------|--------------|----|------|
| 6326 04 00WP2 | 4 | 30 | 15.5 |
| 6326 06 00WP2 | 6 | 33 | 16.5 |
| 6326 08 00WP2 | 8 | 33 | 17.5 |
| 6326 10 00WP2 | 10 | 42 | 21.0 |
| 6326 12 00WP2 | 12 | 45 | 22.0 |

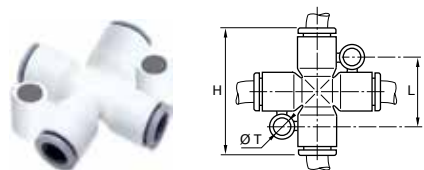

6307 Cross Metric

| PART NUMBER | TUBE SIZE MM | H | L | T |
|---------------|--------------|----|------|-----|
| 6307 06 00WP2 | 6 | 46 | 22.5 | 4.2 |
| 6307 08 00WP2 | 8 | 46 | 22.5 | 4.2 |

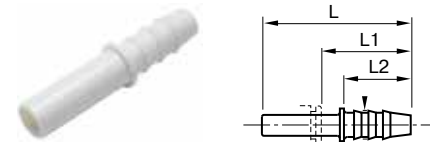

6322 Stem to Hose Barb Inch

| PART NUMBER | STEM SIZE IN | HOSE BARB | L | L1 | L2 |
|---------------|--------------|-----------|------|------|------|
| 6322 56 56WP2 | 1/4 | 1/4 | 1.65 | 1.00 | .67 |
| 6322 60 56WP2 | 3/8 | 1/4 | 1.97 | 1.16 | .87 |
| 6322 60 08WP2 | 3/8 | 5/16 | 1.97 | 1.16 | .87 |
| 6322 60 60WP2 | 3/8 | 3/8 | 1.97 | 1.16 | .87 |
| 6322 62 60WP2 | 1/2 | 3/8 | 2.05 | 1.30 | 1.07 |

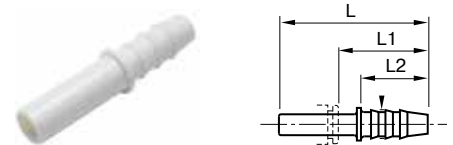

6322 Stem to Hose Barb Metric

| PART NUMBER | STEM SIZE MM | HOSE BARB | L | L1 | L2 |
|---------------|--------------|-----------|------|------|----|
| 6322 06 04WP2 | 6 | 4 | 37.0 | 25.0 | 17 |
| 6322 08 06WP2 | 8 | 6 | 39.5 | 21.0 | 17 |
| 6322 10 07WP2 | 10 | 7 | 50.0 | 29.5 | 22 |

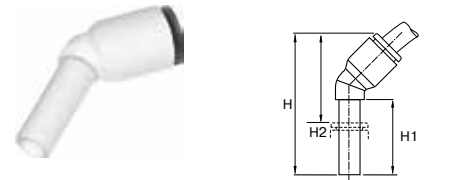

6380 Plug-in 45° Elbow Metric

| PART NUMBER | TUBE SIZE MM | STEM SIZE MM | H | H1 | H2 |
|---------------|--------------|--------------|------|------|------|
| 6380 04 00WP2 | 4 | 4 | 33.5 | 19.0 | 13.0 |
| 6380 06 00WP2 | 6 | 6 | 39.0 | 21.0 | 14.5 |
| 6380 08 00WP2 | 8 | 8 | 44.0 | 21.5 | 19.5 |
| 6380 10 00WP2 | 10 | 10 | 53.0 | 27.0 | 23.0 |
| 6380 12 00WP2 | 12 | 12 | 58.5 | 27.5 | 26.5 |

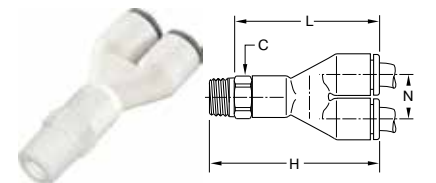

6548 Swivel Y Connector Inch Tube to NPTF

| PART NUMBER | TUBE SIZE IN | NPTF | C HEX | L | H | N |
|---------------|--------------|------|-------|------|------|-----|
| 6548 56 11WP2 | 1/4 | 1/8 | 1/2 | 1.59 | .88 | .45 |
| 6548 56 14WP2 | 1/4 | 1/4 | 1/2 | 1.59 | .88 | .45 |
| 6548 56 18WP2 | 1/4 | 3/8 | 3/4 | 1.62 | .88 | .45 |
| 6548 60 14WP2 | 3/8 | 1/4 | 3/4 | 2.24 | 1.30 | .66 |
| 6548 60 18WP2 | 3/8 | 3/8 | 3/4 | 2.24 | 1.30 | .66 |
| 6548 62 18WP2 | 1/2 | 3/8 | 15/16 | 2.80 | 1.78 | .91 |
| 6548 62 22WP2 | 1/2 | 1/2 | 15/16 | 2.84 | 1.78 | .91 |

WARNING These products can expose you to chemicals including CARBON BLACK, or LEAD, which are known to the state of California to cause cancer, and LEAD which is known to cause birth defects or other reproductive harm. For more information go to www.P65Warnings.ca.gov.



- A
- B
- C
- D
- E
- F
- G
- H
- I
- J
- K
- L
- M
- N
- O

[Click here for CADs, Product Specifications or to Configure Parts Online](#)

A

LIQUIfit Polypropylene Ball Valves

This range of valves offers an innovative solution in the treatment of water and the handling of beverages while protecting health. LIQUIfit's corrosion-resistant, all plastic design makes them ideal for water filtration units, coffee and beverage machines and a wide variety of other fluid applications. The polypropylene material meets all FDA and NSF-51 requirements for food contact.

Assembly Instructions:

1. Inspect the mating threads for debris or damage. Remove any old fluoropolymer tape or sealant on previously used threads. If threads are damaged, replace with new adapter before proceeding.
2. Apply 2 to 3 wraps of fluoropolymer tape, or an NSF/FDA approved silicone sealant. Do not use Plumbers Putty or Pipe Dope. These chemically react with plastic materials and could cause a failure.
3. Align ball valve onto mating thread to ensure cross threading does not occur.
4. Screw ball valve onto mating thread 3 to 5 turns. This should be sufficient to properly seal the threads.
5. Pressurize system and check for leaks.

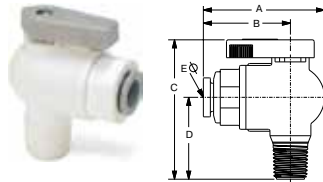

VME - Valve Male Elbow

| PART NO. | NOM. TUBE O.D. | NPTF THREAD SIZE | A | B | C | D | ØE THRU HOLE MIN. |
|-----------|----------------|------------------|------|------|------|------|-------------------|
| LFPP4VME2 | 1/4 | 1/8 | 1.74 | 1.21 | 2.00 | 1.10 | .19 |
| LFPP4VME4 | 1/4 | 1/4 | 1.74 | 1.21 | 2.18 | 1.28 | .19 |
| LFPP4VME6 | 1/4 | 3/8 | 1.74 | 1.21 | 2.18 | 1.28 | .19 |
| LFPP4VME8 | 1/4 | 1/2 | 1.74 | 1.21 | 2.37 | 1.47 | .19 |
| LFPP6VME2 | 3/8 | 1/8 | 1.85 | 1.32 | 2.00 | 1.10 | .25 |
| LFPP6VME4 | 3/8 | 1/4 | 1.85 | 1.32 | 2.18 | 1.28 | .25 |
| LFPP6VME6 | 3/8 | 3/8 | 1.85 | 1.32 | 2.18 | 1.28 | .25 |
| LFPP6VME8 | 3/8 | 1/2 | 1.85 | 1.32 | 2.37 | 1.47 | .25 |
| LFPP8VME8 | 1/2 | 1/2 | 2.73 | 1.74 | 2.38 | 1.47 | .37 |

B

Features/Benefits:

- Full-flow self-cleaning ball maintains the cleanliness of the circuit
- Sealing technology using EPDM D seal
- High temperature, scale-resistant Polysulfone ball
- Tube retention with gripping ring prevents pumping effect
- Push-in connection and disconnection
- FDA compliant

Specifications:

- Temperature range: +35° F to +200° F (+1° C to +93° C)
- O-ring seal material: EPDM
- NSF/ANSI 51 AND 61
- Pressure rated to 150 psi

Advantages:

- Reduce costs – Built-in LIQUIfit connection eliminates the need for a secondary fitting
- Save space – Low profile design allows for easy assembly and access where space is at a premium.

D

E

F

G

H

I

J

K

L

M

N

O

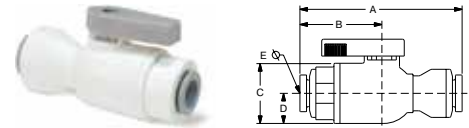

VUC - Valve Union Connector

| PART NO. | 1 TUBE SIZE | 2 TUBE SIZE | A | B | C | D | ØE THRU HOLE MIN. |
|-----------|-------------|-------------|------|------|------|-----|-------------------|
| LFPP4VUC4 | 1/4 | 1/4 | 2.23 | 1.07 | 1.00 | .50 | .19 |
| LFPP4VUC6 | 1/4 | 3/8 | 2.50 | 1.07 | 1.00 | .50 | .19 |
| LFPP6VUC6 | 3/8 | 3/8 | 2.74 | 1.32 | 1.00 | .50 | .25 |
| LFPP8VUC8 | 1/2 | 1/2 | 3.50 | 1.74 | 1.04 | .52 | .37 |

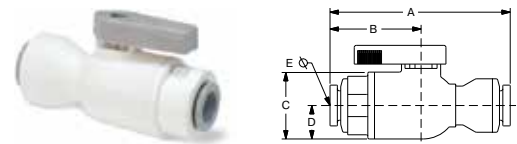

VUC - Valve Union Connector Metric

| PART NO. | 1 TUBE SIZE | 2 TUBE SIZE | A | B | C | D | ØE THRU HOLE MIN. |
|---------------|-------------|-------------|------|-----|-----|-----|-------------------|
| LFPP6MVUC6M | 6 | 6 | 2.24 | .27 | .36 | .13 | .19 |
| LFPP8MVUC8M | 8 | 8 | 2.35 | .27 | .36 | .13 | .25 |
| LFPP10MVUC10M | 10 | 10 | 2.73 | .33 | .36 | .13 | .33 |
| LFPP12MVUC12M | 12 | 12 | 3.46 | .43 | .36 | .13 | .37 |

NOTE: PPL refers to Polypropylene. FCB refers to Fluorocarbon.

WARNING These products can expose you to chemicals including CARBON BLACK, or LEAD, which are known to the state of California to cause cancer, and LEAD which is known to cause birth defects or other reproductive harm. For more information go to www.P65Warnings.ca.gov.



Click here for CADs, Product Specifications or to Configure Parts Online

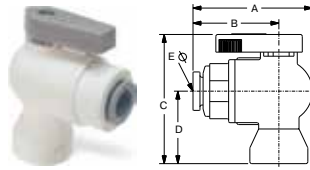

VFE - Valve Female Elbow

| PART NO. | NOM. TUBE O.D. | NPTF THREAD SIZE | A | B | C | D | ØE THRU HOLE MIN. |
|-----------|----------------|------------------|------|------|------|------|-------------------|
| LFPP4VFE2 | 1/4 | 1/8 | 1.74 | 1.21 | 1.82 | .92 | .19 |
| LFPP4VFE4 | 1/4 | 1/4 | 1.74 | 1.21 | 2.05 | 1.15 | .19 |
| LFPP4VFE6 | 1/4 | 3/8 | 1.74 | 1.21 | 2.18 | 1.28 | .19 |
| LFPP6VFE2 | 3/8 | 1/8 | 1.85 | 1.32 | 1.82 | .92 | .25 |
| LFPP6VFE4 | 3/8 | 1/4 | 1.85 | 1.32 | 2.05 | 1.15 | .25 |
| LFPP6VFE6 | 3/8 | 3/8 | 1.85 | 1.32 | 2.18 | 1.28 | .25 |

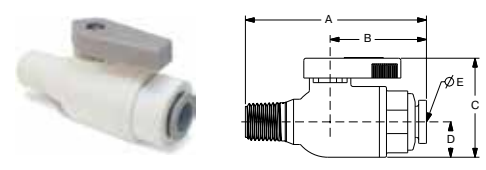

VMC - Valve Male Connector

| PART NO. | NOM. TUBE O.D. | NPTF THREAD SIZE | A | B | C | D | ØE THRU HOLE MIN. |
|-----------|----------------|------------------|------|------|------|-----|-------------------|
| LFPP4VMC2 | 1/4 | 1/8 | 2.22 | 1.21 | 1.40 | .50 | .19 |
| LFPP4VMC4 | 1/4 | 1/4 | 2.40 | 1.21 | 1.40 | .50 | .19 |
| LFPP4VMC6 | 1/4 | 3/8 | 2.40 | 1.21 | 1.40 | .50 | .19 |
| LFPP4VMC8 | 1/4 | 1/2 | 2.59 | 1.21 | 1.40 | .50 | .19 |
| LFPP6VMC2 | 3/8 | 1/8 | 2.33 | 1.32 | 1.40 | .50 | .25 |
| LFPP6VMC4 | 3/8 | 1/4 | 2.51 | 1.32 | 1.40 | .50 | .25 |
| LFPP6VMC6 | 3/8 | 3/8 | 2.51 | 1.32 | 1.40 | .50 | .25 |
| LFPP6VMC8 | 3/8 | 1/2 | 2.70 | 1.32 | 1.40 | .50 | .25 |
| LFPP8VMC8 | 1/2 | 1/2 | 3.14 | 1.74 | 1.40 | .50 | .37 |

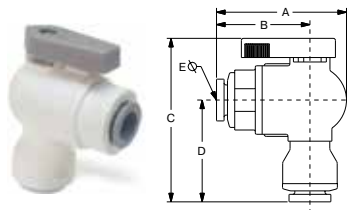

VEU - Valve Elbow Union

| PART NO. | 1 TUBE SIZE | 2 TUBE SIZE | A | B | C | D | ØE THRU HOLE MIN. |
|-----------|-------------|-------------|------|------|------|------|-------------------|
| LFPP4VEU4 | 1/4 | 1/4 | 1.75 | 1.22 | 2.33 | 1.42 | .19 |
| LFPP4VEU6 | 1/4 | 3/8 | 1.75 | 1.22 | 2.33 | 1.42 | .19 |
| LFPP6VEU4 | 3/8 | 1/4 | 1.83 | 1.30 | 2.32 | 1.40 | .19 |
| LFPP6VEU6 | 3/8 | 3/8 | 1.85 | 1.32 | 2.34 | 1.44 | .25 |

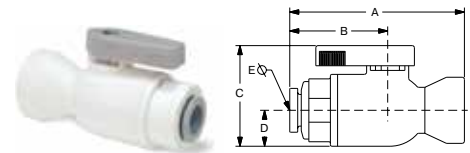

VFC - Valve Female Connector

| PART NO. | NOM. TUBE O.D. | NPTF THREAD SIZE | A | B | C | D | ØE THRU HOLE MIN. |
|-----------|----------------|------------------|------|------|------|-----|-------------------|
| LFPP4VFC2 | 1/4 | 1/8 | 2.04 | 1.21 | 1.40 | .50 | .19 |
| LFPP4VFC4 | 1/4 | 1/4 | 2.27 | 1.21 | 1.40 | .50 | .19 |
| LFPP4VFC6 | 1/4 | 3/8 | 2.40 | 1.21 | 1.40 | .50 | .19 |
| LFPP6VFC2 | 3/8 | 1/8 | 2.15 | 1.32 | 1.40 | .50 | .25 |
| LFPP6VFC4 | 3/8 | 1/4 | 2.38 | 1.32 | 1.40 | .50 | .25 |
| LFPP6VFC6 | 3/8 | 3/8 | 2.51 | 1.32 | 1.40 | .50 | .25 |

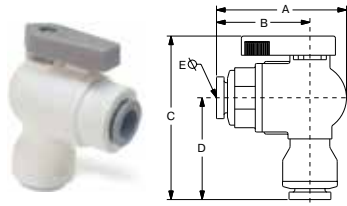

VEU - Valve Elbow Union Metric

| PART NO. | 1 TUBE SIZE | 2 TUBE SIZE | A | B | C | D | ØE THRU HOLE MIN. |
|---------------|-------------|-------------|-----|-----|-----|-----|-------------------|
| LFPP6MVEU6M | 6 | 6 | .41 | .27 | .55 | .31 | .19 |
| LFPP8MVEU8M | 8 | 8 | .41 | .28 | .56 | .33 | .25 |
| LFPP10MVEU10M | 10 | 10 | .48 | .33 | .61 | .38 | .33 |

NOTE: PPL refers to Polypropylene. FCB refers to Fluorocarbon.

WARNING These products can expose you to chemicals including CARBON BLACK, or LEAD, which are known to the state of California to cause cancer, and LEAD which is known to cause birth defects or other reproductive harm. For more information go to www.P65Warnings.ca.gov.



- A
- B
- C
- D
- E
- F
- G
- H
- I
- J
- K
- L
- M
- N
- O

[Click here for CADs, Product Specifications or to Configure Parts Online](#)

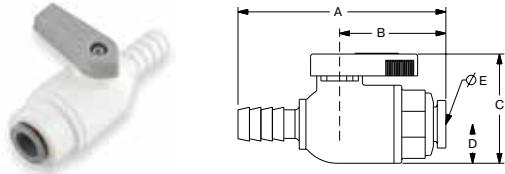

BVC Ball Valve Clip

BV-Clip Shown below holding VUCPB and VME

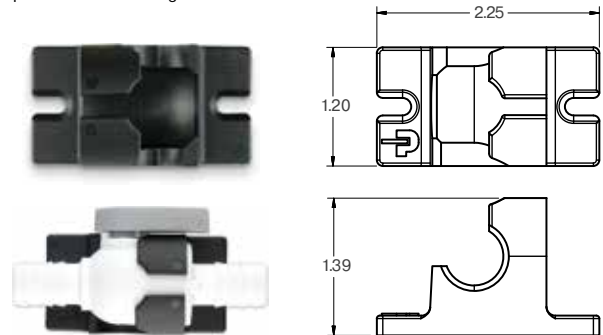

VUCPB - Valve Union Connector Barbed x Tube

| PART NO. | HOSE ID | TUBE OD | OD | A | B | C | D | ØE THRU HOLE MIN. |
|-------------|---------|---------|-----|------|------|------|-----|-------------------|
| LFPP4VUCPB4 | 1/4 | 1/4 | .31 | 2.40 | 1.08 | 1.42 | .50 | .15 |
| LFPP6VUCPB6 | 3/8 | 3/8 | .43 | 2.63 | 1.32 | 1.42 | .50 | .19 |

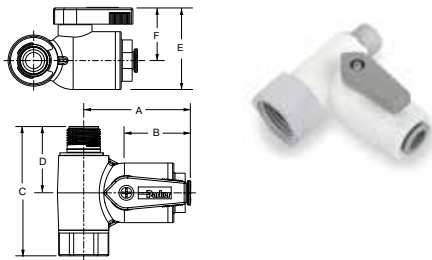

VAS - Valve Angle Stop

| PART NO. | TUBE O.D. | MALE THD. | FEMALE THD. | A | B | C | D | E | F |
|-----------|-----------|-----------|-------------|------|------|------|------|------|-----|
| LFPP4VAS6 | 1/4 | 3/8 | 3/8 | 1.79 | 1.11 | 2.17 | 1.11 | 1.40 | .90 |
| LFPP4VAS8 | 1/4 | 3/8 | 1/2 | 1.79 | 1.11 | 2.40 | 1.11 | 1.40 | .90 |
| LFPP6VAS6 | 3/8 | 3/8 | 3/8 | 2.03 | 1.35 | 2.17 | 1.11 | 1.40 | .90 |
| LFPP6VAS8 | 3/8 | 3/8 | 1/2 | 2.03 | 1.35 | 2.40 | 1.11 | 1.40 | .90 |

Do not use thread sealant. Do not over tighten.

VAS Assembly Instructions:

1. Shut off water supply at brass/chrome supply valve. Disconnect riser from brass/chrome supply valve. Ensure that the sealing gasket is fully seated into the Angle Stop Valve female thread.

2. Install Angle Stop Adapter Valve on supply valve. Connect the riser to the Angle Stop Adapter Valve.

3. Fully insert tubing into the side of the valve. Open valves and check for leaks.

WARNING These products can expose you to chemicals including CARBON BLACK, or LEAD, which are known to the state of California to cause cancer, and LEAD which is known to cause birth defects or other reproductive harm. For more information go to www.P65Warnings.ca.gov.



TrueSeal™ Fittings

Parker's TrueSeal Fittings are lightweight, field attachable and connect to tubing without the use of tools. These all plastic push-to-connect fittings are manufactured from FDA compliant materials.

Product Features:

- Acetal and Black Polypropylene (EPDM seals and metal gripping collet standard)
- White Polypropylene (EPDM seals and plastic gripping collet standard)
- Black Kynar (Fluorocarbon (FKM) seals and black kynar metal gripping collet standard)
- Gripping ring with stainless steel bite edge or with an engineered thermoplastic bite edge
- FDA compliant, NSF/ANSI 51
- Gray acetal and Black Polypropylene NSF/ANSI 61

Markets:

- Food
- Potable Water
- Chemical
- Filtration

Applications:

- Air
- Water
- Soft Drinks
- Beer
- Wine
- Dyes
- Vacuum

Specifications:

Pressure Range

Acetal and Kynar: 1/4", 5/16", 3/8" Vacuum to 300 PSI (20.7 bar)
1/2" Vacuum to 250 PSI (17.2 bar)

Polypropylene: 1/4", 3/8", 1/2" Vacuum to 150 PSI (10.3 bar)

*Vacuum rating to 28 inches of Hg at room temperature

Temperature Range

Acetal: -20° to +180° F (-28.9° to +82.2° C)

Polypropylene: 0° to +225° F (-17.8° to +107.2° C)

Kynar: 0° to +275° F (-17.8° to +135° C)

Compatible Tubing:

- Polyethylene
- Polypropylene**
- Nylon**
- Vinyl*
- Fluoropolymer**
- Polyurethane*
- *Kynar®

* Registered trademark of The Arkema Group.

** Metal gripper required (-MG & -HBLK suffix)

+ Tube Support required.

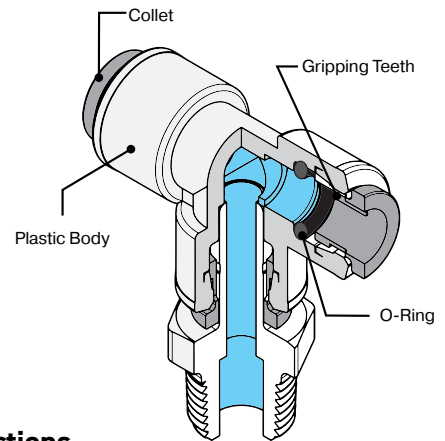

Assembly Instructions

1. Cut tubing square and clean. (Use a Parker plastic tube cutter, Part No. PTC.)
2. Mark from end of tube length of insertion (see table below).
3. Push tube into the fitting until it bottoms out.
4. To remove, depress collet and pull tubing out.

For Threaded Connections:

5. Inspect the mating threads for debris or damage. Remove any old fluoropolymer tape or sealant on previously used threads. If threads are damaged, replace with new adapter before proceeding.
6. Apply 1 to 2 wraps of Teflon tape to the male pipe threads, or an NSF/FDA approved silicon sealant. Do not use plumbers putty or pipe dope. These chemically react with plastic materials and could cause a failure.
7. Screw together until finger tight (approximately three turns)
8. To ensure seal continue 1 to 2 more turns past finger tight.
9. Total number of turns from start to finish need not exceed 5 turns.

| TUBE SIZE | O.D. TOLERANCE | INSERTION DEPTH |
|-----------|----------------|-----------------|
| 1/4 | ±.005 | 11/16 |
| 5/16 | ±.005 | 13/16 |
| 3/8 | ±.005 | 3/4 |
| 1/2 | ±.005 | 7/8 |

WARNING These products can expose you to chemicals including CARBON BLACK, which is known to the state of California to cause cancer. For more information go to www.P65Warnings.ca.gov.



Threaded Fittings

MC

Male Connector
NPTF
p. C19



FA

Faucet Adapter
UNS
p. C20



MES

Male Elbow Swivel
NPTF
p. C20



MRS

Male Run Tee
Swivel – NPTF
p. C20



MTS

Male Branch Tee
Swivel
NPTF
p. C21



FC

Female Connector
NPTF
p. C22



TMC

Male Standpipe
NPTF
p. C22



ME

Male Elbow
NPTF
p. C23



FF

45° Female Flare
p. C24



ST

Straight Thread
p. C24



FE

Female Elbow
NPTF
p. C25



Tube to Tube Fittings

EU

Union Elbow
p. C19



TU

Union Tee
p. C19



UC

Union
p. C21



WY

Union Y
p. C21



CU

Cross
p. C24



Bulkhead Union

BU

Bulkhead Union
p. C22



Plug-In Fittings

TEU

Tube Elbow Union
p. C23



RD

Tube Reducer
p. C23



Check Valves

VC

Check Valve
p. C27



MCVC

Kynar Check Valve
p. C27



Accessories

TCB

Barbed Connector
p. C24



TFA

Faucet Adapter
p. C24



TAF

Faucet Adapter
p. C24



CAP

Cap
p. C24



TPL

Plug
p. C25



TEB

Barbed Connector
p. C25



TSC

Cartridge
p. C26



SC

Safety Clip
p. C30



TS

Tube Support
p. C30



AQRT

Release Tool
p. C30



BVC

Ball Valve Clip
p. C30



Ball Valves

VME

Male Elbow
p. C28



VFE

Female Elbow
p. C28



VUC

Union Connector
p. C29



VFC

Female Connector
p. C29



VMC

Male Connector
p. C29



VEU

Elbow Union
p. C30



VTEU

Elbow Union
p. C30



WARNING These products can expose you to chemicals including CARBON BLACK, which is known to the state of California to cause cancer. For more information go to www.P65Warnings.ca.gov.

[Click here for CADs, Product Specifications or to Configure Parts Online](#)

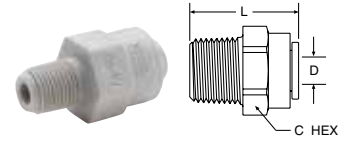

MC - Male Connector

Tube-to-Pipe

| GRAY ACETAL EPDM SEAL | BLACK PPL EPDM SEAL | WHITE PPL EPDM SEAL | BLACK KYNAR FKM SEAL | NOM TUBE O.D. | NPTF THREAD SIZE | C HEX | L OVERALL LENGTH | FLOW DIA. D |
|-----------------------|---------------------|---------------------|----------------------|---------------|------------------|-------|------------------|-------------|
| A4MC2-MG | PPB4MC2-MG | PP4MC2 | FB4MC2-HBLK | 1/4 | 1/8 | 11/16 | 1.28 | .175 |
| A4MC4-MG | PPB4MC4-MG | PP4MC4 | FB4MC4-HBLK | 1/4 | 1/4 | 11/16 | 1.14 | .175 |
| A4MC6-MG | PPB4MC6-MG | PP4MC6 | FB4MC6-HBLK | 1/4 | 3/8 | 11/16 | 1.18 | .175 |
| A5MC2-MG | | | FB5MC2-HBLK | 5/16 | 1/8 | 13/16 | 1.46 | .175 |
| A5MC4-MG | | | FB5MC4-HBLK | 5/16 | 1/4 | 13/16 | 1.41 | .188 |
| A5MC6-MG | | | FB5MC6-HBLK | 5/16 | 3/8 | 13/16 | 1.27 | .188 |
| A6MC2-MG | | PP6MC2 | FB6MC2-HBLK | 3/8 | 1/8 | 13/16 | 1.46 | .175 |
| A6MC4-MG | PPB6MC4-MG | PP6MC4 | FB6MC4-HBLK | 3/8 | 1/4 | 13/16 | 1.41 | .250 |
| A6MC6-MG | PPB6MC6-MG | PP6MC6 | FB6MC6-HBLK | 3/8 | 3/8 | 13/16 | 1.27 | .250 |
| A6MC8-MG | | | FB6MC8-HBLK | 3/8 | 1/2 | 15/16 | 1.45 | .250 |
| A8MC6-MG | PPB8MC6-MG | PP8MC6 | FB8MC6-HBLK | 1/2 | 3/8 | 15/16 | 1.65 | .360 |
| A8MC8-MG | PPB8MC8-MG | PP8MC8 | FB8MC8-HBLK | 1/2 | 1/2 | 15/16 | 1.46 | .375 |

For nonstandard plastic collet, remove -MG suffix.

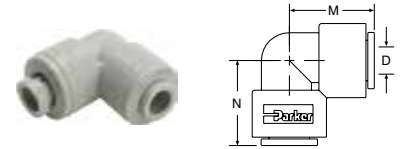

EU - Elbow Union

Tube-to-Tube

| GRAY ACETAL EPDM SEAL | BLACK PPL EPDM SEAL | WHITE PPL EPDM SEAL | BLACK KYNAR FKM SEAL | NOM. TUBE O.D. | M | N | FLOW DIA. D |
|-----------------------|---------------------|---------------------|----------------------|----------------|-------|------|-------------|
| A4EU4-MG | PPB4EU4-MG | PP4EU4 | FB4EU4-HBLK | 1/4 | .87 | .87 | .175 |
| A5EU4-MG | | | | 5/16-1/4 | 1.052 | .90 | .175 |
| A5EU5-MG | | | FB5EU5-HBLK | 5/16 | 1.02 | 1.02 | .188 |
| A6EU4-MG | PPB6EU4-MG | PP6EU4 | FB6EU4-HBLK | 3/8-1/4 | 1.02 | .90 | .212 |
| A6EU5-MG | | | | 3/8-5/16 | 1.02 | 1.02 | .175 |
| A6EU6-MG | PPB6EU6-MG | PP6EU6 | FB6EU6-HBLK | 3/8 | 1.02 | 1.02 | .250 |
| A8EU6-MG | PPB8EU6-MG | | | 1/2-3/8 | 1.20 | 1.20 | .250 |
| A8EU8-MG | PPB8EU8-MG | PP8EU8 | FB8EU8-HBLK | 1/2 | 1.20 | 1.20 | .375 |

For nonstandard plastic collet, remove -MG suffix.

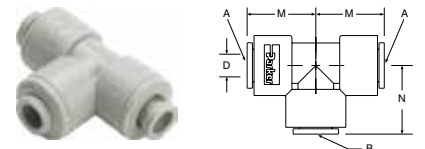

TU - Tee Union

Tube-to-Tube

| GRAY ACETAL EPDM SEAL | BLACK PPL EPDM SEAL | WHITE PPL EPDM SEAL | BLACK KYNAR FKM SEAL | NOM. TUBE O.D. | | M | N | FLOW DIA. D |
|-----------------------|---------------------|---------------------|----------------------|----------------|-------------|------|------|-------------|
| | | | | TUBE A RUN | TUBE B STEM | | | |
| A4TU4-MG | PPB4TU4-MG | PP4TU4 | FB4TU4-HBLK | 1/4 | 1/4 | .81 | .85 | .175 |
| A5TU5-MG | | | FB5TU5-HBLK | 5/16 | 5/16 | 1.02 | 1.02 | .188 |
| A6TU4-MG | PPB6TU4-MG | PP6TU4 | FB6TU4-HBLK | 3/8 | 1/4 | 1.02 | 1.03 | .175 |
| A6TU6-MG | PPB6TU6-MG | PP6TU6 | FB6TU6-HBLK | 3/8 | 3/8 | 1.02 | 1.02 | .290 |
| A8TU8-MG | PPB8TU8-MG | PP8TU8 | FB8TU8-HBLK | 1/2 | 1/2 | 1.20 | 1.20 | .375 |

For nonstandard plastic collet, remove -MG suffix.

WARNING These products can expose you to chemicals including CARBON BLACK, which is known to the state of California to cause cancer. For more information go to www.P65Warnings.ca.gov.



- A
- B
- C
- D
- E
- F
- G
- H
- I
- J
- K
- L
- M
- N
- O

Click here for CADs, Product Specifications or to Configure Parts Online

- A
- B
- C
- D
- E
- F
- G
- H
- I
- J
- K
- L
- M
- N
- O

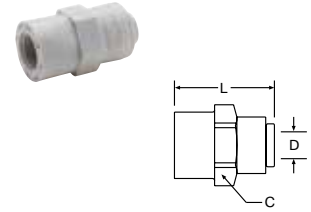

FA - Faucet Adapter

Tube-to-Faucet

| GRAY ACETAL EPDM SEAL | BLACK PPL EPDM SEAL | WHITE PPL EPDM SEAL | BLACK KYNAR FKM SEAL | NOM. TUBE O.D. | UNS-2B THREAD SIZE | C HEX | L OVERALL LENGTH | FLOW DIA. D |
|-----------------------|---------------------|---------------------|----------------------|----------------|--------------------|-------|------------------|-------------|
| A4FA7-MG | PPB4FA7-MG | PP4FA7 | FB4FA7-HBLK | 1/4 | 7/16-24 | 23/32 | 1.32 | .190 |
| A5FA7-MG | | | | 5/16 | 7/16-24 | 13/16 | 1.41 | .190 |
| A6FA7-MG | PPB6FA7-MG | PP6FA7 | FB6FA7-HBLK | 3/8 | 7/16-24 | 13/16 | 1.41 | .190 |

For nonstandard plastic collet, remove -MG suffix.

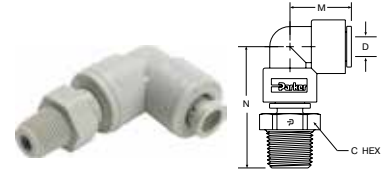

MES - Male Elbow Swivel

Tube-to-Pipe

| GRAY ACETAL EPDM SEAL | BLACK PPL EPDM SEAL | WHITE PPL EPDM SEAL | BLACK KYNAR FKM SEAL | NOM. TUBE O.D. | NPTF THREAD SIZE | C HEX | M | N | FLOW DIA. D |
|-----------------------|---------------------|---------------------|----------------------|----------------|------------------|-------|------|------|-------------|
| A4MES2-MG | PPB4MES2-MG | PP4MES2 | FB4MES2-HBLK | 1/4 | 1/8 | 9/16 | .87 | 1.60 | .175 |
| A4MES4-MG | PPB4MES4-MG | PP4MES4 | FB4MES4-HBLK | 1/4 | 1/4 | 11/16 | .87 | 1.71 | .175 |
| A4MES6-MG | | PP4MES6 | FB4MES6-HBLK | 1/4 | 3/8 | 13/16 | .90 | 1.91 | .212 |
| A5MES2-MG | | | | 5/16 | 1/8 | 9/16 | 1.02 | 1.78 | .188 |
| A5MES4-MG | | | | 5/16 | 1/4 | 11/16 | 1.02 | 1.90 | .188 |
| A5MES6-MG | | | | 5/16 | 3/8 | 13/16 | 1.02 | 1.90 | .188 |
| A6MES2-MG | | | FB6MES2-HBLK | 3/8 | 1/8 | 9/16 | 1.02 | 1.65 | .175 |
| A6MES4-MG | PPB6MES4-MG | PP6MES4 | FB6MES4-HBLK | 3/8 | 1/4 | 13/16 | 1.02 | 1.90 | .250 |
| A6MES6-MG | PPB6MES6-MG | PP6MES6 | FB6MES6-HBLK | 3/8 | 3/8 | 13/16 | 1.02 | 1.90 | .250 |
| A8MES4-MG | | | | 1/2 | 1/4 | 13/16 | 1.20 | 2.10 | .240 |
| A8MES6-MG | | PP8MES6 | | 1/2 | 3/8 | 13/16 | 1.20 | 2.10 | .375 |
| A8MES8-MG | | PP8MES8 | | 1/2 | 1/2 | 1 | 1.20 | 2.32 | .375 |

* Part consists of elbow union and tube stem adaptor.

Note: Assemblies with metal gripper collets are permanent. Assemblies with plastic collets can be taken apart.

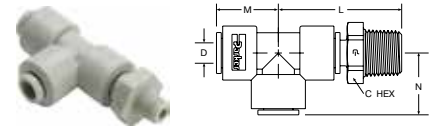

MRS - Male Run Tee Swivel

Tube-to-Pipe

| GRAY ACETAL EPDM SEAL | BLACK PPL EPDM SEAL | WHITE PPL EPDM SEAL | BLACK KYNAR FKM SEAL | NOM. TUBE O.D. | NPTF THREAD SIZE | C HEX | L | M | N | D THRU HOLE MIN. |
|-----------------------|---------------------|---------------------|----------------------|----------------|------------------|-------|------|------|------|------------------|
| A4MRS2-MG | PPB4MRS2 | PP4MRS2 | FB4MRS2-HBLK | 1/4 | 1/8 | 9/16 | 1.55 | .81 | 0.85 | .175 |
| A4MRS4-MG | PPB4MRS4-MG | PP4MRS4 | FB4MRS4-HBLK | 1/4 | 1/4 | 11/16 | 1.67 | .81 | 0.85 | .175 |
| A5MRS2-MG | | | | 5/16 | 1/8 | 9/16 | 1.78 | 1.02 | 1.02 | .188 |
| A5MRS4-MG | | | | 5/16 | 1/4 | 11/16 | 1.90 | 1.02 | 1.02 | .188 |
| A5MRS6-MG | | | | 5/16 | 3/8 | 13/16 | 1.90 | 1.02 | 1.02 | .188 |
| A6MRS4-MG | PPB6MRS4-MG | PP6MRS4 | FB6MRS4-HBLK | 3/8 | 1/4 | 13/16 | 1.90 | 1.02 | 1.02 | .250 |
| A6MRS6-MG | PPB6MRS6-MG | PP6MRS6 | FB6MRS6-HBLK | 3/8 | 3/8 | 13/16 | 1.90 | 1.02 | 1.02 | .250 |
| A8MRS4-MG | | | | 1/2 | 1/4 | 13/16 | 2.10 | 1.20 | 1.20 | .240 |
| A8MRS6-MG | | PP8MRS6 | | 1/2 | 3/8 | 13/16 | 2.10 | 1.20 | 1.20 | .375 |
| A8MRS8-MG | | PP8MRS8 | | 1/2 | 1/2 | 1 | 2.32 | 1.20 | 1.20 | .375 |

*Part consists of tee union and tube stem adaptor.

Note: Assemblies with metal gripper collets are permanent. Assemblies with plastic collets can be taken apart.

WARNING These products can expose you to chemicals including CARBON BLACK, which is known to the state of California to cause cancer. For more information go to www.P65Warnings.ca.gov.



Click here for CADs, Product Specifications or to Configure Parts Online

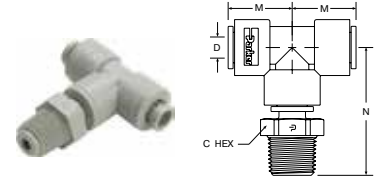

MTS - Male Tee Swivel

Tube-to-Pipe

| GRAY ACETAL EPDM SEAL | BLACK PPL EPDM SEAL | WHITE PPL EPDM SEAL | BLACK KYNAR FKM SEAL | NOM. TUBE O. D. | NPTF THREAD SIZE | C HEX | M | N | FLOW DIA. D |
|-----------------------|---------------------|---------------------|----------------------|-----------------|------------------|-------|------|------|-------------|
| A4MTS2-MG | PPB4MTS2 | PP4MTS2 | FB4MTS2-HBLK | 1/4 | 1/8 | 9/16 | .81 | 1.60 | .175 |
| A4MTS4-MG | PPB4MTS4-MG | PP4MTS4 | FB4MTS4-HBLK | 1/4 | 1/4 | 11/16 | .81 | 1.71 | .175 |
| A5MTS2-MG | | | | 5/16 | 1/8 | 9/16 | 1.02 | 1.78 | .188 |
| A5MTS4-MG | | | | 5/16 | 1/4 | 11/16 | 1.02 | 1.90 | .188 |
| A5MTS6-MG | | | | 5/16 | 3/8 | 13/16 | 1.02 | 1.90 | .188 |
| A6MTS2-MG | | | FB6MTS2-HBLK | 3/8 | 1/8 | 9/16 | 1.02 | 1.75 | .175 |
| A6MTS4-MG | PPB6MTS4-MG | PP6MTS4 | FB6MTS4-HBLK | 3/8 | 1/4 | 13/16 | 1.02 | 1.90 | .250 |
| A6MTS6-MG | PPB6MTS6-MG | PP6MTS6 | FB6MTS6-HBLK | 3/8 | 3/8 | 13/16 | 1.02 | 1.90 | .250 |
| A8MTS4-MG | | | | 1/2 | 1/4 | 13/16 | 1.20 | 2.10 | .240 |
| A8MTS6-MG | | PP8MTS6 | | 1/2 | 3/8 | 13/16 | 1.20 | 2.10 | .375 |
| A8MTS8-MG | | PP8MTS8 | | 1/2 | 1/2 | 1 | 1.20 | 2.32 | .375 |

* Part consists of tee union and tube stem adaptor.
 Note: Assemblies with metal gripper collets are permanent. Assemblies with plastic collets can be taken apart.

UC - Union Connector

Tube-to-Tube

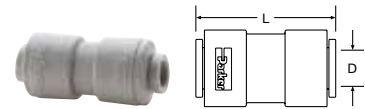

| GRAY ACETAL EPDM SEAL | BLACK PPL EPDM SEAL | WHITE PPL EPDM SEAL | BLACK KYNAR FKM SEAL | NOM. TUBE O. D. | L OVERALL LENGTH | FLOW DIA. D |
|-----------------------|---------------------|---------------------|----------------------|-----------------|------------------|-------------|
| A4UC4-MG | PPB4UC4-MG | PP4UC4 | FB4UC4-HBLK | 1/4 | 1.49 | .175 |
| A5UC4-MG | | | | 5/16-1/4 | 1.70 | .175 |
| A5UC5-MG | | | FB5UC5-HBLK | 5/16 | 1.70 | .188 |
| A6UC4-MG | PPB6UC4-MG | PP6UC4 | FB6UC4-HBLK | 3/8-1/4 | 1.70 | .175 |
| A6UC5-MG | | | | 3/8-5/16 | 1.70 | .188 |
| A6UC6-MG | PPB6UC6-MG | PP6UC6 | FB6UC6-HBLK | 3/8 | 1.70 | .250 |
| A8UC5-MG | | | | 1/2-5/16 | 1.90 | .188 |
| A8UC6-MG | PPB8UC6-MG | PP8UC6 | FB8UC6-HBLK | 1/2-3/8 | 1.90 | .250 |
| A8UC8-MG | PPB8UC8-MG | PP8UC8 | FB8UC8-HBLK | 1/2 | 1.91 | .375 |

For nonstandard plastic collet, remove -MG suffix.

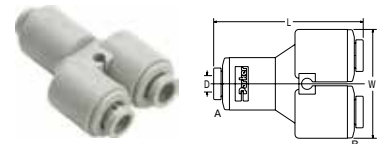

WY - "Y" Union

Tube-to-Tube

| GRAY ACETAL EPDM SEAL | WHITE PPL EPDM SEAL | BLACK KYNAR FKM SEAL | NOM. TUBE O. D. | | L | W | FLOW DIA. D |
|-----------------------|---------------------|----------------------|------------------|--------------------|-------|------|-------------|
| | | | INLET TUBE A RUN | OUTLET TUBE B STEM | | | |
| | | FB4WY4-HBLK | 1/4 | 1/4 | 2.100 | 1.43 | .190 |
| A5WY5-MG | | FB5WY5-HBLK | 5/16 | 5/16 | 2.250 | 1.75 | .190 |
| A6WY4-MG | | FB6WY4-HBLK | 3/8 | 1/4 | 2.100 | 1.43 | .190 |
| A6WY5-MG | | | 3/8 | 5/16 | 2.200 | 1.75 | .190 |
| A6WY6-MG | | FB6WY6-HBLK | 3/8 | 3/8 | 2.175 | 1.75 | .250 |
| | | FB8WY6-HBLK | 1/2 | 3/8 | 2.370 | 1.93 | .250 |
| | | FB8WY8-HBLK | 1/2 | 1/2 | 2.370 | 1.93 | .380 |

WARNING These products can expose you to chemicals including CARBON BLACK, which is known to the state of California to cause cancer. For more information go to www.P65Warnings.ca.gov.



Click here for CADs, Product Specifications or to Configure Parts Online

A

B

C

D

E

F

G

H

I

J

K

L

M

N

O

FC - Female Connector

Tube-to-Pipe

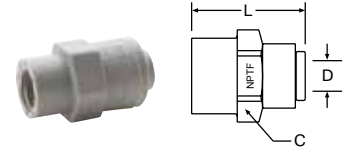

| GRAY ACETAL EPDM SEAL | BLACK PPL EPDM SEAL | WHITE PPL EPDM SEAL | BLACK KYNAR FKM SEAL | NOM. TUBE O.D. | NPTF THREAD SIZE | C HEX | L OVERALL LENGTH | FLOW DIA. D |
|-----------------------|---------------------|---------------------|----------------------|----------------|------------------|-------|------------------|-------------|
| A4FC2-MG | PPB4FC2-MG | PP4FC2 | FB4FC2-HBLK | 1/4 | 1/8 | 11/16 | 1.20 | .175 |
| A4FC4-MG | PPB4FC4-MG | PP4FC4 | FB4FC4-HBLK | 1/4 | 1/4 | 23/32 | 1.32 | .175 |
| A5FC4-MG | | | FB5FC4-HBLK | 5/16 | 1/4 | 13/16 | 1.41 | .188 |
| A5FC6-MG | | | | 5/16 | 3/8 | 1 | 1.50 | .188 |
| A6FC4-MG | PPB6FC4-MG | PP6FC4 | FB6FC4-HBLK | 3/8 | 1/4 | 13/16 | 1.41 | .250 |
| A6FC6-MG | PPB6FC6-MG | PP6FC6 | FB6FC6-HBLK | 3/8 | 3/8 | 1 | 1.50 | .250 |
| A6FC8-MG | | | FB6FC8-HBLK | 3/8 | 1/2 | 1-1/8 | 1.52 | .250 |
| A8FC6-MG | | PP8FC6 | FB8FC6-HBLK | 1/2 | 3/8 | 1-1/8 | 1.60 | .375 |
| A8FC8-MG | | PP8FC8 | FB8FC8-HBLK | 1/2 | 1/2 | 1-1/8 | 1.75 | .375 |

For nonstandard plastic collet, remove -MG suffix.

TMC - Tube Stem Adapter

Tube Stem-to-Pipe

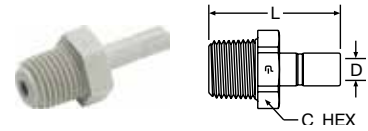

| GRAY ACETAL EPDM SEAL | BLACK PPL EPDM SEAL | WHITE PPL EPDM SEAL | BLACK KYNAR FKM SEAL | NOM. TUBE O.D. | NPTF THREAD SIZE | C HEX | L OVERALL LENGTH | FLOW DIA. D |
|-----------------------|---------------------|---------------------|----------------------|----------------|------------------|-------|------------------|-------------|
| A4TMC2 | PPB4TMC2 | PP4TMC2 | FB4TMC2 | 1/4 | 1/8 | 9/16 | 1.44 | .175 |
| A4TMC4 | PPB4TMC4 | PP4TMC4 | FB4TMC4 | 1/4 | 1/4 | 11/16 | 1.56 | .175 |
| A5TMC2 | | | | 5/16 | 1/8 | 9/16 | 1.5 | .188 |
| A5TMC4 | | | FB5TMC4 | 5/16 | 1/4 | 11/16 | 1.67 | .188 |
| A5TMC6 | | | | 5/16 | 3/8 | 13/16 | 1.67 | .188 |
| A6TMC4 | PPB6TMC4 | PP6TMC4 | FB6TMC4 | 3/8 | 1/4 | 13/16 | 1.70 | .250 |
| A6TMC6 | PPB6TMC6 | PP6TMC6 | FB6TMC6 | 3/8 | 3/8 | 13/16 | 1.70 | .250 |
| A6TMC8 | | | | 3/8 | 1/2 | 15/16 | 1.90 | .250 |
| A8TMC4 | | | | 1/2 | 1/4 | 13/16 | 1.82 | .240 |
| A8TMC6 | | PP8TMC6 | FB8TMC6 | 1/2 | 3/8 | 13/16 | 1.82 | .375 |
| A8TMC8 | | PP8TMC8 | FB8TMC8 | 1/2 | 1/2 | 1 | 2.04 | .375 |

BU - Bulkhead Union

Tube-to-Tube

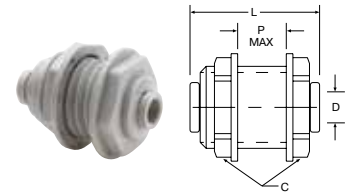

| GRAY ACETAL EPDM SEAL | BLACK PPL EPDM SEAL | WHITE PPL EPDM SEAL | BLACK KYNAR FKM SEAL | NOM. TUBE O.D. | C1 HEX | C2 HEX | L OVERALL LENGTH | P MAX. WALL THICKNESS | FLOW DIA. D | BKHD HOLE DRILL SIZE |
|-----------------------|---------------------|---------------------|----------------------|----------------|--------|--------|------------------|-----------------------|-------------|----------------------|
| A4BU4-MG | PPB4BU4-MG | PP4BU4 | FB4BU4-HBLK | 1/4 | 15/16 | 15/16 | 1.50 | .50 | .175 | 7/8 |
| A5BU5-MG | | | FB5BU5-HBLK | 5/16 | 1-1/16 | 1-1/16 | 1.75 | .62 | .188 | 1 |
| A6BU4-MG | PPB6BU4-MG | PP6BU4 | FB6BU4-HBLK | 3/8-1/4 | 1-1/16 | 1-1/16 | 1.75 | .62 | .175 | 1 |
| A6BU6-MG | PPB6BU6-MG | PP6BU6 | FB6BU6-HBLK | 3/8 | 1-1/16 | 1-1/16 | 1.75 | .62 | .250 | 1 |
| A8BU8-MG | | | FB8BU8-HBLK | 1/2 | 1-1/4 | 1-1/4 | 2.04 | .70 | .375 | 1-1/8 |

For nonstandard plastic collet, remove -MG suffix.

WARNING These products can expose you to chemicals including CARBON BLACK, which is known to the state of California to cause cancer. For more information go to www.P65Warnings.ca.gov.



Click here for CADs, Product Specifications or to Configure Parts Online

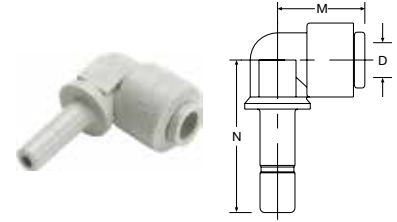

TEU - Tube Elbow Union

Tube-to-Tube Stem

| GRAY ACETAL EPDM SEAL | BLACK PPL EPDM SEAL | WHITE PPL EPDM SEAL | BLACK KYNAR FKM SEAL | NOM. TUBE O.D. | TUBE STEM O.D. | M | N | FLOW DIA. D |
|-----------------------|---------------------|---------------------|----------------------|----------------|----------------|------|------|-------------|
| A4TEU4-MG | PPB4TEU4-MG | PP4TEU4 | FB4TEU4-HBLK | 1/4 | 1/4 | .84 | 1.21 | .125 |
| A4TEU6-MG | | | FB4TEU6-HBLK | 1/4 | 3/8 | .84 | 1.35 | .125 |
| A5TEU5-MG | | | FB5TEU5-HBLK | 5/16 | 5/16 | 1.03 | 1.40 | .188 |
| A6TEU4-MG | | | FB6TEU4-HBLK | 3/8 | 1/4 | 1.03 | 1.29 | .125 |
| A6TEU6-MG | PPB6TEU6 | PP6TEU6 | FB6TEU6-HBLK | 3/8 | 3/8 | 1.03 | 1.48 | .250 |
| A8TEU8-MG | PPB8TEU8-MG | PP8TEU8 | FB8TEU8-HBLK | 1/2 | 1/2 | 1.21 | 1.64 | .380 |

For nonstandard plastic collet, remove -MG suffix.

RD - Tube Reducer

Tube-to-Tube Stem

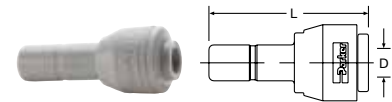

| GRAY ACETAL EPDM SEAL | BLACK PPL EPDM SEAL | WHITE PPL EPDM SEAL | BLACK KYNAR FKM SEAL | NOM. TUBE O.D. | TUBE STEM O.D. | L | FLOW DIA. D |
|-----------------------|---------------------|---------------------|----------------------|----------------|----------------|------|-------------|
| A4RD5-MG | | PP4RD5 | | 1/4 | 5/16 | 1.62 | .18 |
| A4RD6-MG | PPB4RD6-MG | PP4RD6 | FB4RD6-HBLK | 1/4 | 3/8 | 1.62 | .18 |
| A5RD6-MG | | | | 5/16 | 3/8 | 1.78 | .25 |
| A5RD8-MG | | | | 5/16 | 1/2 | 1.90 | .25 |
| A6RD8-MG | | | FB6RD8-HBLK | 3/8 | 1/2 | 1.90 | .25 |

For nonstandard plastic collet, remove -MG suffix.

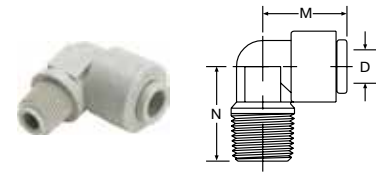

ME - Male Elbow

Tube-to-Pipe

| GRAY ACETAL EPDM SEAL | BLACK PPL EPDM SEAL | WHITE PPL EPDM SEAL | BLACK KYNAR FKM SEAL | NOM. TUBE O.D. | NPTF THREAD SIZE | M | N | FLOW DIA. D |
|-----------------------|---------------------|---------------------|----------------------|----------------|------------------|------|------|-------------|
| A4ME2-MG | PPB4ME2-MG | PP4ME2 | FB4ME2-HBLK | 1/4 | 1/8 | .84 | .94 | .175 |
| A4ME4-MG | PPB4ME4-MG | PP4ME4 | FB4ME4-HBLK | 1/4 | 1/4 | .84 | .94 | .175 |
| A4ME6-MG | PPB4ME6-MG | PP4ME6 | FB4ME6-HBLK | 1/4 | 3/8 | .84 | 1.04 | .175 |
| A5ME4-MG | | | FB5ME4-HBLK | 5/16 | 1/4 | 1.03 | 1.08 | .175 |
| A5ME6-MG | | | FB5ME6-HBLK | 5/16 | 3/8 | 1.03 | 1.06 | .188 |
| A6ME4-MG | | PP6ME4 | FB6ME4-HBLK | 3/8 | 1/4 | 1.03 | 1.08 | .250 |
| A6ME6-MG | PPB6ME6-MG | PP6ME6 | FB6ME6-HBLK | 3/8 | 3/8 | 1.03 | 1.06 | .250 |

For nonstandard plastic collet, remove -MG suffix.

WARNING These products can expose you to chemicals including CARBON BLACK, which is known to the state of California to cause cancer. For more information go to www.P65Warnings.ca.gov.



- A
- B
- C
- D
- E
- F
- G
- H
- I
- J
- K
- L
- M
- N
- O

Click here for CADs, Product Specifications or to Configure Parts Online

- A
- B
- C
- D
- E
- F
- G
- H
- I
- J
- K
- L
- M
- N
- O

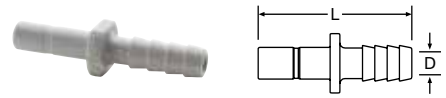

TCB - Tube-to-Barb Connector

| GRAY ACETAL | BLACK PPL EPDM SEAL | WHITE POLYPROPYLENE | BLACK KYNAR FKM SEAL | TUBE STEM O.D. | TUBE I.D. | L OVERALL LENGTH | FLOW DIA. D |
|-------------|---------------------|---------------------|----------------------|----------------|-----------|------------------|-------------|
| A4TCB4 | PPB4TCB4 | PP4TCB4 | FB4TCB4 | 1/4 | 1/4 | 1.67 | .140 |
| A6TCB4 | | | FB6TCB4 | 3/8 | 1/4 | 1.82 | .140 |
| A6TCB6 | PPB6TCB6 | PP6TCB6 | FB6TCB6 | 3/8 | 3/8 | 1.98 | .250 |
| A8TCB6 | | | | 1/2 | 3/8 | 2.10 | .250 |
| A8TCB8 | | | FB8TCB8 | 1/2 | 1/2 | 2.10 | .375 |

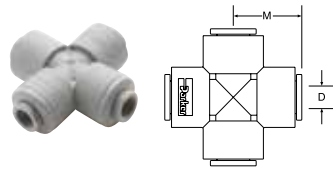

CU - Cross Union

Tube-to-Tube

| GRAY ACETAL EPDM SEAL | WHITE PPL EPDM SEAL | BLACK KYNAR FCB SEAL | NOM. TUBE O.D. | M | FLOW DIA. D |
|-----------------------|---------------------|----------------------|----------------|------|-------------|
| A4CU4-MG | | | 1/4 | .91 | .175 |
| A6CU6-MG | | FB6CU6-HBLK | 3/8 | 1.08 | .250 |

For nonstandard plastic collet, remove -MG suffix.

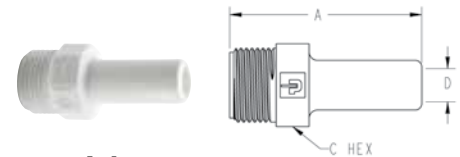

TAF - Tube Faucet Adapter

(Male Thread)

| WHITE ACETAL | TUBE STEM O.D. | THREAD SIZE | A | C HEX | D MIN. |
|--------------|----------------|-------------|------|-------|--------|
| AW6TAF7-MG | 3/8 | 7/16-24 | 1.41 | .50 | .22 |
| AW6TAF8-MG | 3/8 | 1/2-14 NPSM | 1.65 | .88 | .22 |
| AW6TAF9-MG | 3/8 | 9/16-24 | 1.45 | .63 | .22 |

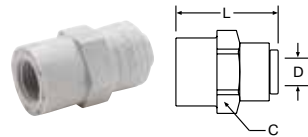

FF - 45° Female Flare

Tube-to-Flare

| GRAY ACETAL EPDM SEAL | WHITE PPL EPDM SEAL | BLACK KYNAR FKM SEAL | NOM. TUBE O.D. | UNF-2B THREAD SIZE | C HEX | L OVERALL LENGTH | FLOW DIA. D |
|-----------------------|---------------------|----------------------|----------------|--------------------|-------|------------------|-------------|
| A4FF4-MG | PP4FF4 | FB4FF4-HBLK | 1/4 | 7/16-20 | 23/32 | 1.32 | .190 |
| A6FF4-MG | | FB6FF4-HBLK | 3/8 | 7/16-20 | 13/16 | 1.41 | .190 |
| A6FF6-MG | PP6FF6 | FB6FF6-HBLK | 3/8 | 5/8-18 | 1 | 1.50 | .250 |

For nonstandard plastic collet, remove -MG suffix.

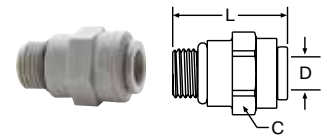

ST - Straight Thread

Tube-to-Male O-Ring Boss

| GRAY ACETAL EPDM SEAL | WHITE PPL EPDM SEAL | BLACK KYNAR FKM SEAL | NOM. TUBE O.D. | UNF-2B THD SIZE | C HEX | L OVERALL LENGTH | FLOW DIA. D |
|-----------------------|---------------------|----------------------|----------------|-----------------|-------|------------------|-------------|
| A6ST9-MG | | FB6ST9-HBLK | 3/8 | 9/16-18 | 13/16 | 1.39 | .250 |

For nonstandard plastic collet, remove -MG suffix.

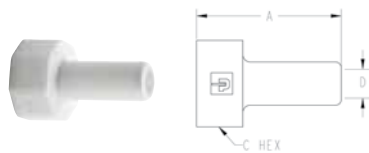

TFA - Tube Faucet Adapter

(Female Thread)

| WHITE ACETAL | TUBE STEM O.D. | THREAD SIZE | A | C HEX | D MIN. |
|--------------|----------------|-------------|------|-------|--------|
| AW6TFA7-MG | 3/8 | 7/16-24 | 1.25 | .69 | .17 |
| AW6TFA8-MG | 3/8 | 1/2-14 NPSM | 1.45 | 1.06 | .22 |
| AW6TFA9-MG | 3/8 | 9/16-24 | 1.25 | .75 | .22 |



CAP - Tube Cap

| GRAY ACETAL EPDM SEAL | WHITE PPL EPDM SEAL | NATURAL KYNAR FKM SEAL | NOM. TUBE O.D. | L OVERALL LENGTH |
|-----------------------|---------------------|------------------------|----------------|------------------|
| A4CAP-MG | PP4CAP | FB4CAP-HBLK | 1/4 | .77 |
| A6CAP-MG | PP6CAP | | 3/8 | 0.88 |

For nonstandard plastic collet, remove -MG suffix.

WARNING These products can expose you to chemicals including CARBON BLACK, which is known to the state of California to cause cancer. For more information go to www.P65Warnings.ca.gov.



Click here for CADs, Product Specifications or to Configure Parts Online

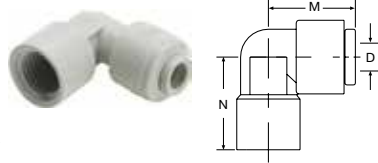

FE - Female Elbow

Tube-to-Pipe

| GRAY ACETAL EPDM SEAL | WHITE PPL EPDM SEAL | BLACK KYNAR FKM SEAL | NOM. TUBE O.D. | NPTF THREAD SIZE | M | N | FLOW DIA. D |
|-----------------------|---------------------|----------------------|----------------|------------------|------|------|-------------|
| A4FE4-MG | | FB4FE4-HBLK | 1/4 | 1/4 | .84 | 1.00 | .18 |
| A6FE4-MG | | FB6FE4-HBLK | 3/8 | 1/4 | 1.03 | 1.00 | .25 |
| A6FE6-MG | | FB6FE6-HBLK | 3/8 | 3/8 | 1.03 | 1.00 | .25 |

For nonstandard plastic collet, remove -MG suffix.

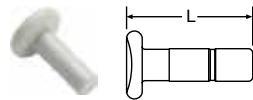

TPL - Plug

| GRAY ACETAL | BLACK PPL | WHITE PPL | BLACK KYNAR | FITTING SIZE | L OVERALL LENGTH |
|-------------|------------|-----------|-------------|--------------|------------------|
| A4TPL | PPB4TPL | PP4TPL | FB4TPL | 1/4 | 0.88 |
| A6TPL | PPB6TPL-MG | PP6TPL | FB6TPL | 3/8 | 1.45 |
| A8TPL | PPB8TPL | PP8TPL | FB8TPL | 1/2 | 1.50 |



TEB - Tube Elbow Barb Connector

| GRAY ACETAL | WHITE POLYPROPYLENE | BLACK KYNAR | TUBE STEM O.D. | TUBE I.D. | M | N | FLOW DIA. D |
|-------------|---------------------|-------------|----------------|-----------|-------|-------|-------------|
| A4TEB4 | PP4TEB4 | FB4TEB4 | 1/4 | 1/4 | .89 | 1.00 | .140 |
| A6TEB4 | PP6TEB4 | FB6TEB4 | 3/8 | 1/4 | 1.335 | 1.055 | .375 |
| A6TEB6 | PP6TEB6 | FB6TEB6 | 3/8 | 3/8 | 1.34 | 1.21 | .250 |
| A8TEB8 | | FB8TEB8 | 1/2 | 1/2 | 1.30 | 1.30 | .390 |

WARNING These products can expose you to chemicals including CARBON BLACK, which is known to the state of California to cause cancer. For more information go to www.P65Warnings.ca.gov.



- A
- B
- C
- D
- E
- F
- G
- H
- I
- J
- K
- L
- M
- N
- O

Click here for CADs, Product Specifications or to Configure Parts Online



TSC - Cartridge Insert

| PART NO. WITH EPDM SEAL | NOM. TUBE O.D. | A* DIAMETER ±002 | B DIAMETER ±003 | C DIAMETER ±003 | D DIAMETER MAXIMUM | E DEPTH ±002 | F DEPTH ±002 | G DEPTH ±002 | H* CENTERLINE OF PORTS MINIMUM |
|-------------------------|----------------|------------------|-----------------|-----------------|--------------------|--------------|--------------|--------------|--------------------------------|
| ATSC4-MG | 1/4 | .528 | .421 | .260 | .19 | .230 | .435 | .600 | .670 |
| ATSC6-MG | 3/8 | .632 | .545 | .385 | .31 | .280 | .455 | .705 | .790 |
| ATSC8-MG | 1/2 | .774 | .668 | .510 | .41 | .315 | .510 | .810 | 1.250 |

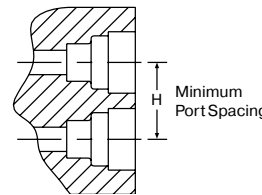
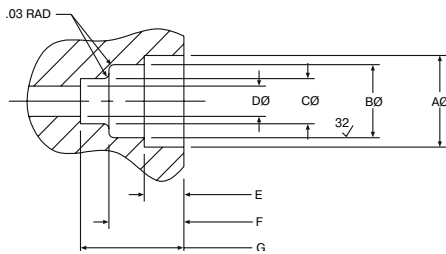

Parker TrueSeal™ Cartridge Inserts:

Allow you to machine or mold a tube connection into your equipment or components. By using cartridge inserts, you will reduce your material and assembly costs, reduce potential leak paths, and give your equipment a new, clean profile by eliminating the need for threaded connections. TSC Cartridge Inserts consist of 1 o-ring, 1 cartridge, and 1 collet.

*Cartridge inserts are rated at 150 PSI in ports dimensioned as above and having Noryl as the receiving material. Other materials may have different ratings and require different port dimensions. Consult the Fluid System Connectors Division when using polypropylene, unfilled polypropylene, ABS or Nylon.

NORYL® is a registered trademark of the General Electric Co.

Assembly Instructions:

1. Machine or mold the receiving orifice as per the above dimensions.
2. Place the cartridge insert squarely onto the prepared port opening making sure that the barbs of the cartridge are going into the hole and the lettering on the face of the cartridge is visible.
3. Using a rubber mallet or press, insert the cartridge into the first gland orifice until its face is flush with the top surface of the port.
4. Insert the o-ring into the cartridge and seat it evenly into the second gland orifice.
5. Insert the collet into the cartridge opening.
6. Insert tubing.

WARNING These products can expose you to chemicals including CARBON BLACK, which is known to the state of California to cause cancer. For more information go to www.P65Warnings.ca.gov.



Click here for CADs, Product Specifications or to Configure Parts Online

TrueSeal Check Valves

Push-to-Connect check valves that ensures protection against reversal of flow. The valves have an arrow molded into the body to indicate the direction of flow. Valves are designed for connection with either thermoplastic or soft metal tubing and are intended for use with liquids only.

Materials of Construction

| | |
|--------------------------|--|
| Body | Acetal |
| O-ring | EPDM |
| Metal Grip Edge | 300 Stainless |
| Working Pressure | Up to 150 PSI (10.3 bar) depending on tubing being used |
| Temperature Range | +34° to +150° F (+1° to +65° C) |
| Cracking Pressure | 1/3 PSI (0.02 bar) |

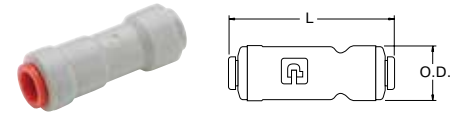

VC – Check Valve

| PART NO. | TUBE SIZE | L | O.D. |
|----------|-----------|------|------|
| A4VC4-MG | 1/4 | 2.00 | .66 |
| A5VC5-MG | 5/16 | 2.10 | .70 |
| A6VC6-MG | 3/8 | 2.15 | .80 |
| A8VC8-MG | 1/2 | 2.68 | .91 |

PVDF Check Valves

Materials of Construction

| | |
|--------------------------|-----------------------------------|
| Body | Kynar® |
| O-ring | Fluorocarbon |
| Metal Grip Edge | Stainless Steel |
| Working Pressure | Up to 300 PSI (20.7 bar) |
| Temperature Range | 0° to +250° F (-17.8° to +121° C) |

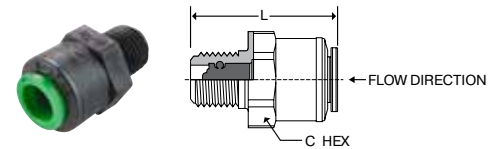

MCVC Kynar® Check Valves

| PART NO. | TUBE O.D. | NPTF THREAD | L | C HEX | CRACKING PRESSURE PSI |
|------------------|-----------|-------------|------|-------|-----------------------|
| FB6MCVC4-HBLK-05 | 3/8 | 1/4 | 1.40 | 13/16 | .5 |

Note: For check valve to function properly tubing needs to be installed

WARNING These products can expose you to chemicals including CARBON BLACK, which is known to the state of California to cause cancer. For more information go to www.P65Warnings.ca.gov.



Click here for CADs, Product Specifications or to Configure Parts Online

- A
- B
- C
- D
- E
- F
- G
- H
- I
- J
- K
- L
- M
- N
- O

Polypropylene Ball Valves

For proven leak-free performance, specify Polypropylene Ball Valves. Their corrosion-resistant, all-plastic design makes them ideal for water filtration units, coffee and beverage machines and a wide variety of other fluid applications. Polypropylene material meets all FDA and NSF-51 requirements for food contact.

Features/Benefits:

- Precision molded, all-plastic design is leak free and corrosion resistant.
- Polypropylene material offers a wider chemical acceptance range, as well as a wide temperature range.
- Bi-directional flow maximizes productivity.
- Full flow design reduces pressure drop across the valve.
- Special o-ring seal ensures a reliable leak-tight connection.
- TrueSeal™ connection reduces potential leaks.

Specifications:

- Temperature range: +35° to +200°F (+2° to +93°C)
- O-ring seal material: EPDM
- NSF/ANSI 51 AND 61
- Pressure rated to 150 PSI (10.3 bar). Actual working pressures with be lower at elevated temperatures

Advantages:

- Reduce costs—Built-in TrueSeal™ connection eliminates the need for a secondary fitting.
- Save space—Low-profile design allows for easy assembly and access where space is at a premium.

VME - Valve Male Elbow

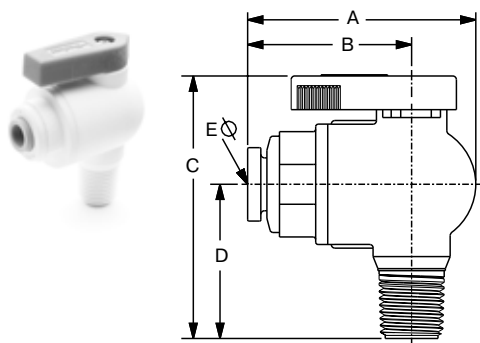

| PART NUMBER | NOM. TUBE O.D. | NPTF THREAD SIZE | A | B | C | D | ØE THRU HOLE MIN. |
|----------------|----------------|------------------|------|------|------|------|-------------------|
| PP4VME2-MG (+) | 1/4 | 1/8 | 1.74 | 1.21 | 2.00 | 1.10 | .19 |
| PP4VME4-MG | 1/4 | 1/4 | 1.74 | 1.21 | 2.18 | 1.28 | .19 |
| PP4VME6-MG | 1/4 | 3/8 | 1.74 | 1.21 | 2.18 | 1.28 | .19 |
| PP4VME8-MG (+) | 1/4 | 1/2 | 1.74 | 1.21 | 2.37 | 1.47 | .19 |
| PP6VME2-MG (+) | 3/8 | 1/8 | 1.85 | 1.32 | 2.00 | 1.10 | .25 |
| PP6VME4-MG | 3/8 | 1/4 | 1.85 | 1.32 | 2.18 | 1.28 | .25 |
| PP6VME6-MG | 3/8 | 3/8 | 1.85 | 1.32 | 2.18 | 1.28 | .25 |
| PP6VME8-MG | 3/8 | 1/2 | 1.85 | 1.32 | 2.37 | 1.47 | .25 |

VFE - Valve Female Elbow

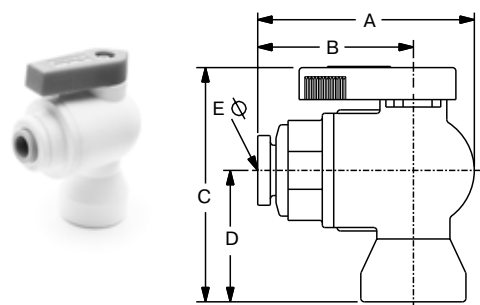

| PART NUMBER | NOM. TUBE O.D. | NPTF THREAD SIZE | A | B | C | D | ØE THRU HOLE MIN. |
|----------------|----------------|------------------|------|------|------|------|-------------------|
| PP4VFE2-MG (+) | 1/4 | 1/8 | 1.74 | 1.21 | 1.82 | .92 | .19 |
| PP4VFE4-MG | 1/4 | 1/4 | 1.74 | 1.21 | 2.05 | 1.15 | .19 |
| PP4VFE6-MG | 1/4 | 3/8 | 1.74 | 1.21 | 2.18 | 1.28 | .19 |
| PP6VFE2-MG (+) | 3/8 | 1/8 | 1.85 | 1.32 | 1.82 | .92 | .25 |
| PP6VFE4-MG | 3/8 | 1/4 | 1.85 | 1.32 | 2.05 | 1.15 | .25 |
| PP6VFE6-MG | 3/8 | 3/8 | 1.85 | 1.32 | 2.18 | 1.28 | .25 |

(+) Non Standard.

WARNING These products can expose you to chemicals including CARBON BLACK, which is known to the state of California to cause cancer. For more information go to www.P65Warnings.ca.gov.



Click here for CADs, Product Specifications or to Configure Parts Online

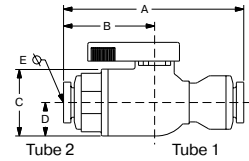

VUC - Valve Union Connector

| BLACK POLYPROPYLENE | WHITE POLYPROPYLENE | 1 TUBE SIZE | 2 TUBE SIZE | A | B | C | D | Ø THRU HOLE MIN. |
|---------------------|---------------------|-------------|-------------|------|------|-----|----|------------------|
| PPB4VUC4-MG | PP4VUC4-MG | 1/4 | 1/4 | 2.55 | 1.22 | 1.0 | .5 | .19 |
| | PP4VUC6-MG | 1/4 | 3/8 | 2.55 | 1.22 | 1.0 | .5 | .19 |
| | PP6VUC4-MG | 3/8 | 1/4 | 2.57 | 1.30 | 1.0 | .5 | .19 |
| PPB6VUC6-MG | PP6VUC6-MG | 3/8 | 3/8 | 2.67 | 1.32 | 1.4 | .5 | .25 |
| | PP8VUC8-MG | 1/2 | 1/2 | 2.94 | 1.55 | 1 | .5 | .38 |

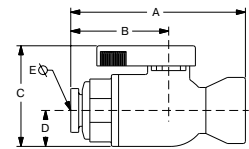

VFC - Valve Female Connector

| BLACK POLYPROPYLENE | WHITE POLYPROPYLENE | NOM. TUBE O.D. | NPTF THREAD SIZE | A | B | C | D | Ø THRU HOLE MIN. |
|---------------------|---------------------|----------------|------------------|------|------|-----|----|------------------|
| | PP4VFC2-MG | 1/4 | 1/8 | 2.04 | 1.21 | 1.4 | .5 | .19 |
| | PP4VFC4-MG | 1/4 | 1/4 | 2.27 | 1.21 | 1.4 | .5 | .19 |
| | PP4VFC6-MG | 1/4 | 3/8 | 2.40 | 1.21 | 1.4 | .5 | .19 |
| | PP6VFC2-MG | 3/8 | 1/8 | 2.15 | 1.32 | 1.4 | .5 | .25 |
| PPB6VFC4-MG | PP6VFC4-MG | 3/8 | 1/4 | 2.38 | 1.32 | 1.4 | .5 | .25 |
| PPB6VFC6-MG | PP6VFC6-MG | 3/8 | 3/8 | 2.51 | 1.32 | 1.4 | .5 | .25 |

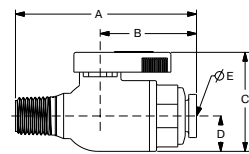

VMC - Valve Male Connector

| BLACK POLYPROPYLENE | WHITE POLYPROPYLENE | NOM. TUBE O.D. | NPTF THREAD SIZE | A | B | C | D | Ø THRU HOLE MIN. |
|---------------------|---------------------|----------------|------------------|------|------|-----|----|------------------|
| | PP4VMC2-MG (+) | 1/4 | 1/8 | 2.22 | 1.21 | 1.4 | .5 | .19 |
| PPB4VMC4-MG | PP4VMC4-MG | 1/4 | 1/4 | 2.40 | 1.21 | 1.4 | .5 | .19 |
| | PP4VMC6-MG | 1/4 | 3/8 | 2.40 | 1.21 | 1.4 | .5 | .19 |
| | PP4VMC8-MG (+) | 1/4 | 1/2 | 2.59 | 1.21 | 1.4 | .5 | .19 |
| | PP6VMC2-MG (+) | 3/8 | 1/8 | 2.33 | 1.32 | 1.4 | .5 | .25 |
| | PP6VMC4-MG | 3/8 | 1/4 | 2.51 | 1.32 | 1.4 | .5 | .25 |
| | PP6VMC6-MG | 3/8 | 3/8 | 2.51 | 1.32 | 1.4 | .5 | .25 |
| | PP6VMC8-MG (+) | 3/8 | 1/2 | 2.70 | 1.32 | 1.4 | .5 | .25 |

WARNING These products can expose you to chemicals including CARBON BLACK, which is known to the state of California to cause cancer. For more information go to www.P65Warnings.ca.gov.



- A
- B
- C
- D
- E
- F
- G
- H
- I
- J
- K
- L
- M
- N
- O

Click here for CADs, Product Specifications or to Configure Parts Online

- A
- B
- C
- D
- E
- F
- G
- H
- I
- J
- K
- L
- M
- N
- O

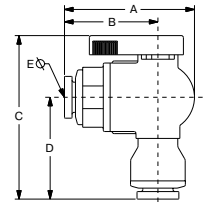

VEU - Valve Elbow Union

| BLACK POLYPROPYLENE | WHITE POLYPROPYLENE | 1 TUBE SIZE | 2 TUBE SIZE | A | B | C | D | ØE THRU HOLE MIN. |
|---------------------|---------------------|-------------|-------------|------|------|------|------|-------------------|
| | PP4VEU4-MG | 1/4 | 1/4 | 1.75 | 1.22 | 2.33 | 1.42 | .19 |
| | PP4VEU6-MG | 1/4 | 3/8 | 1.75 | 1.22 | 2.33 | 1.42 | .11 |
| | PP6VEU4-MG | 3/8 | 1/4 | 1.83 | 1.30 | 2.32 | 1.40 | .19 |
| PPB6VEU6-MG | PP6VEU6-MG | 3/8 | 3/8 | 1.85 | 1.32 | 2.34 | 1.44 | .25 |
| | PP8VEU8-MG | 1/2 | 1/2 | 1.93 | 1.39 | 2.51 | 1.61 | 0.38 |

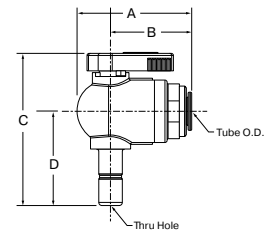

VTEU - Valve Tube Elbow Union

| BLACK POLYPROPYLENE | WHITE POLYPROPYLENE | NOM. TUBE O.D. | STEM | A | B | C | D | ØE THRU HOLE MIN. |
|---------------------|---------------------|----------------|------|------|------|------|------|-------------------|
| PPB6VTEU6-MG | PP4VTEU6-MG | 1/4 | 3/8 | 1.75 | 1.22 | 2.43 | 1.50 | .17 |
| | PP6VTEU6-MG | 3/8 | 3/8 | 1.83 | 1.30 | 2.43 | 1.50 | .25 |



SC - Safety Clip

(Patent No. 6,065,779)

| PART NUMBER | PART NUMBER | FOR NOMINAL TUBE O.D. |
|-------------|-------------|-----------------------|
| SC-4 | SC-4-B | 1/4 |
| SC-5 | SC-5-B | 5/16 |
| SC-6 | SC-6-B | 3/8 |
| SC-8 | SC-8-B | 1/2 |

AQRT - Quick Release Tool

Makes disconnection of tube adapters and tubing a breeze.



BVC Ball Valve Clip

BV-Clip Shown below holding VUCPB and VME

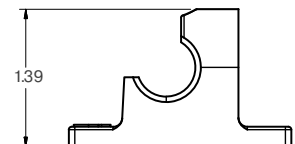
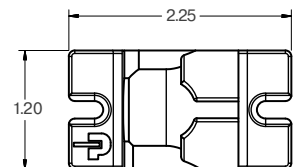

TS - Tube Supports

| NYLON PART NO. | PPL PART NUMBER |
|----------------|-----------------|
| N4TS3 | P4TS3 |
| N5TS3 | P5TS3 |
| N6TS4 | P6TS4 |
| N8TS6 | P8TS6 |

To be used with soft durometer tubing.

WARNING These products can expose you to chemicals including CARBON BLACK, which is known to the state of California to cause cancer. For more information go to www.P65Warnings.ca.gov.



A
B
C
D
E
F
G
H
I
J
K
L
M
N
O



Fast & Tite® Fittings

Parker's Fast & Tite Fittings are a compression style fitting that installs in seconds without tools and provides a tight, sure, leak proof seal without clamps or adjustments. A unique grab ring for tube retention, coupled with a Nitrile o-ring creates a positive seal and assures good tube retention with only hand tight assembly.

Product Features:

- Available in black polypropylene and white nylon
- White polypropylene available as a non-standard part
- 302 stainless steel grab ring
- Nitrile O-ring
- FDA compliant material
- NSF/ANSI-51

Markets:

- Water Filtration
- Beverage Dispensing
- Life Science
- Bottling
- Semi-Conductor

Applications:

- Water
- Beverages
- Food
- Cooling Systems
- Vacuum

Compatible Tubing:

- Thermoplastic
- Soft Metal
- Glass

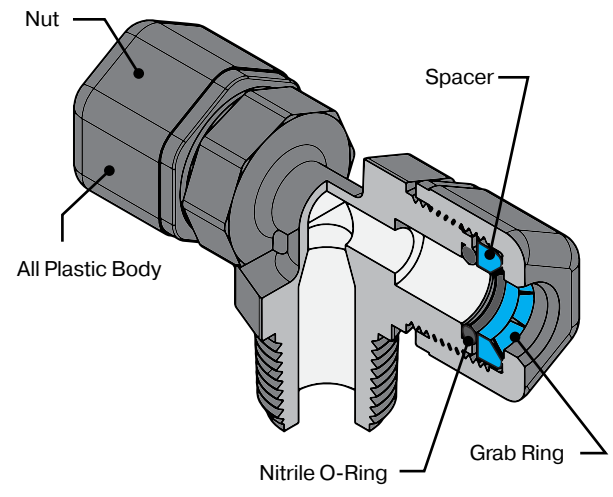

Specifications:

Air-Oil-Water Pressure in PSI (bar)

| TUBE O. D. IN. | UP TO 75° F | 76° TO 125° F | 126° TO 175° F |
|----------------|-------------|---------------|----------------|
| 1/4 | 300 (20.7) | 300 (20.7) | 300 (20.7) |
| 5/16 | 300 (20.7) | 300 (20.7) | 300 (20.7) |
| 3/8 | 250 (17.2) | 250 (17.2) | 150 (10.3) |
| 1/2 | 200 (13.8) | 200 (13.8) | 150 (10.3) |
| 5/8 | 150 (10.3) | 100 (6.9) | 50 (3.5) |

Temperature Range

| | |
|----------------|------------------------------------|
| Nylon: | -40° to +200° F (-40° to +93.3° C) |
| Polypropylene: | 0° to +212° F (-17.8° to +100° C) |

| TUBE O.D. (IN.) | INSERTION LENGTH |
|-----------------|------------------|
| 1/4 | 5/8 |
| 5/16 | 5/8 |
| 3/8 | 13/16 |
| 1/2 | 7/8 |
| 5/8 | 1 |

Assembly Instructions

1. Cut the tube squarely and remove any burrs.
2. Mark from end of tube the length of insertion. If using a tube support, insert fully into tube before marking. (See insertion length table left)
3. Loosen nut on fitting until three threads are visible. Fittings for glass tubes must be disassembled and the grab ring removed. If the fitting has been disassembled the components are to be placed in the following order: fitting body, o-ring, spacer, grab ring and nut. Assemble the nut until three threads are showing on the body before inserting tube.
4. Moisten end of the tube with water. Push the tube Straight into fitting until it bottoms on the fitting's shoulder. Tighten nut by hand. Additional tightening should not be necessary, but 1/4 additional turn may be added if desired. Do not overtighten nut as the threads will strip and the fitting will not function properly. A proper assembly will not show the insertion mark extending beyond the nut. If the insertion mark is visible, then steps 1 thru 4 must be repeated.
5. Whenever a Fast & Tite® fitting is assembled for service or reuse the stainless steel grab ring should be replaced for maximum tubing retention.

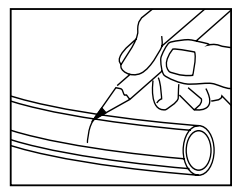
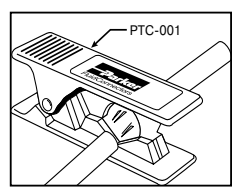

Note: Provide adequate fail-safe mechanisms such as leakage detection sensors, automatic shut-off controls or other industry and code appropriate fail-safe devices in the design of your water-handling appliance to protect against personal injury and property damage. Plastic fittings containing an o-ring have a finite life depending on the environment, media and severity of the application. Frequent inspections and replacement of the fitting when anomalies are found is recommended.

WARNING These products can expose you to chemicals including CARBON BLACK, which is known to the state of California to cause cancer. For more information go to www.P65Warnings.ca.gov.



Threaded Fittings

MC

Male Connector
NPTF
p. C33



ME

Male Elbow
NPTF
p. C33



FE

Female Elbow
NPTF
p. C34



FC

Female Connector
NPTF
p. C34



MR

Male Run Tee
NPTF
p. C34



MT

Male Branch Tee
NPTF
p. C34



Tube to Tube Fittings

UC

Union
p. C33



EU

Union Elbow
p. C33



TU

Union Tee
p. C34



Bulkhead Unions

BU

Bulkhead Union
p. C34



Accessories

GR

Grab Ring
p. C35



NS

Nut & Spacer
p. C35



TS

Tube Support
p. C35



OR

O-Ring
p. C35



Ball Valves

VUC

Valve Union
Connector
p. C36



VMC

Valve Male
Connector
p. C36



VFC

Valve Female
Connector
p. C36



VFE

Valve Female
Elbow
p. C37



VME

Valve Male Elbow
p. C37



VEU

Valve Elbow Union
p. C37



WARNING These products can expose you to chemicals including CARBON BLACK, which is known to the state of California to cause cancer. For more information go to www.P65Warnings.ca.gov.

Click here for CADs, Product Specifications or to Configure Parts Online

GR - Grab Ring



(Stainless or Plastic)

| STAINLESS GRAB RING PART NUMBER | PLASTIC GRAB RING PART NUMBER | FOR NOM. TUBE O.D. |
|---------------------------------|-------------------------------|--------------------|
| 4GR | 4GRP | 1/4 |
| 5GR | 5GRP | 5/16 |
| 6GR | 6GRP | 3/8 |
| 8GR | 8GRP | 1/2 |
| 10GR | 10GRP | 5/8 |

NS - Nut and Spacer Sets



| WHITE POLYPROPYLENE PART NO. | BLACK POLYPROPYLENE PART NO. | WHITE NYLON PARTNUMBER | FOR NOM. TUBE O.D. |
|------------------------------|------------------------------|------------------------|--------------------|
| | P4NS | N4NS | 1/4 |
| | P5NS | N5NS | 5/16 |
| | P6NS | N6NS | 3/8 |
| | P8NS | N8NS | 1/2 |
| | P10NS | N10NS | 5/8 |

*Non-standard part, contact division for price and availability.

TS - Tube Support



| POLYPROPYLENE PART NO. | NYLON PART NO. | FOR TUBE PART NO. |
|------------------------|----------------|-------------------|
| P4TS3 | N4TS3 | PV43 |
| P5TS3 | N5TS3 | PV53 |
| P6TS4 | N6TS4 | PV64 |
| P8TS6 | N8TS6 | PV86 |
| P10TS8 | N10TS8 | PV108 |

OR - O-Ring



| FOR NOM. TUBE O.D. | NITRILE O-RING | FLUOROCARBON O-RING | EPDM O-RING |
|--------------------|----------------|---------------------|-------------|
| 1/4 | 4OR | 4OR-V | 4OR-EPDM |
| 5/16 | 5OR | 5OR-V | 5OR-EPDM |
| 3/8 | 6OR | 6OR-V | 6OR-EPDM |
| 1/2 | 8OR | 8OR-V | 8OR-EPDM |
| 5/8 | 10OR | 10OR-V | 10OR-EPDM |

WARNING These products can expose you to chemicals including CARBON BLACK, which is known to the state of California to cause cancer. For more information go to www.P65Warnings.ca.gov.



- A
- B
- C
- D
- E
- F
- G
- H
- I
- J
- K
- L
- M
- N
- O

[Click here for CADs, Product Specifications or to Configure Parts Online](#)

Fast and Tite Ball Valves

This range of ball valves uses compression technology to create a sure and tight connection. Use Parker's Fast and Tite fittings for low pressure applications such as water filtration, beverage dispensing, or on vacuum lines. Manufactured from black polypropylene material, these valves meet FDA and NSF-51 requirements for food contact.

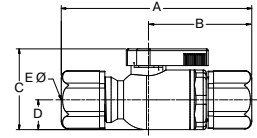

Features/Benefits:

- 302 Stainless Steel Grab Ring
- Nitrile O-ring
- FDA Compliant
- NSF/ANSI-51 Compliant

Specifications:

- Temperature Range: +35° F to +200° F (+1° C to +93° C)
- O-ring Seal Material: Nitrile
- NSF/ANSI 51
- Pressure Rated to 150PSI

Assembly Instructions:

1. Cut the tube squarely and remove any burrs.
2. Mark from end of tube the length of insertion. If using a tube support, insert fully into tube before marking. (See insertion length table left)
3. Loosen nut on fitting until three threads are visible. Fittings for glass tubes must be disassembled and the grab ring removed. If the fitting has been disassembled the components are to be placed in the following order: fitting body, o-ring, spacer, grab ring and nut. Assemble the nut until three threads are showing on the body before inserting tube.
4. Moisten end of the tube with water. Push the tube straight into fitting until it bottoms on the fitting's shoulder. Tighten nut by hand. Additional tightening should not be necessary, but 1/4 additional turn may be added if desired. Do not overtighten nut as the threads will strip and the fitting will not function properly. A proper assembly will not show the insertion mark extending beyond the nut. If the insertion mark is visible, then steps 1 thru 4 must be repeated.
5. Whenever a Fast & Tite® fitting is assembled for service or reuse the stainless steel grab ring should be replaced for maximum tubing retention.

Note: Provide adequate fail-safe mechanisms such as leakage detection sensors, automatic shut-off controls or other industry and code appropriate fail-safe devices in the design of your water-handling appliance to protect against personal injury and property damage. Plastic fittings containing an o-ring have a finite life depending on the environment, media and severity of the application. Frequent inspections and replacement of the fitting when anomalies are found is recommended.

VUC - Valve Union Connector

| PART NO. | 1 TUBE SIZE | 2 TUBE SIZE | A | B | C | D | ØE THRU HOLE MIN. |
|------------|-------------|-------------|------|------|-----|----|-------------------|
| FTPPB4VUC4 | 1/4 | 1/4 | 2.94 | 1.61 | 1.4 | .5 | .19 |
| FTPPB4VUC6 | 1/4 | 3/8 | 3.07 | 1.61 | 1.4 | .5 | .19 |
| FTPPB6VUC6 | 3/8 | 3/8 | 3.19 | 1.73 | 1.4 | .5 | .25 |
| FTPPB8VUC8 | 1/2 | 1/2 | 3.27 | 1.80 | 1.4 | .5 | .38 |

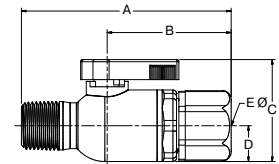

VMC - Valve Male Connector

| PART NO. | 1 TUBE SIZE | NPTF THD SIZE | A | B | C | D | ØE THRU HOLE MIN. |
|------------|-------------|---------------|------|------|-----|----|-------------------|
| FTPPB4VMC4 | 1/4 | 1/4 | 2.81 | 1.61 | 1.4 | .5 | .19 |
| FTPPB4VMC6 | 1/4 | 3/8 | 2.81 | 1.61 | 1.4 | .5 | .19 |
| FTPPB6VMC4 | 3/8 | 1/4 | 2.93 | 1.73 | 1.4 | .5 | .19 |
| FTPPB6VMC6 | 3/8 | 3/8 | 2.93 | 1.73 | 1.4 | .5 | .25 |
| FTPPB8VMC6 | 1/2 | 3/8 | 3.00 | 1.79 | 1.4 | .5 | .25 |

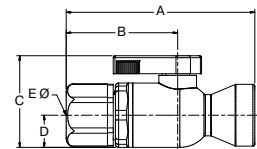

VFC - Valve Female Connector

| PART NO. | 1 TUBE SIZE | NPTF THD SIZE | A | B | C | D | ØE THRU HOLE MIN. |
|------------|-------------|---------------|------|------|-----|----|-------------------|
| FTPPB4VFC4 | 1/4 | 1/4 | 2.78 | 1.61 | 1.4 | .5 | .19 |
| FTPPB6VFC6 | 3/8 | 3/8 | 2.93 | 1.73 | 1.4 | .5 | .25 |
| FTPPB8VFC6 | 1/2 | 3/8 | 3.00 | 1.8 | 1.4 | .5 | .25 |

WARNING These products can expose you to chemicals including CARBON BLACK, which is known to the state of California to cause cancer. For more information go to www.P65Warnings.ca.gov.



Click here for CADs, Product Specifications or to Configure Parts Online

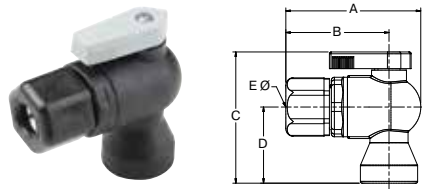

VFE - Valve Female Elbow

| PART NO. | 1 TUBE SIZE | NPTF THD SIZE | A | B | C | D | ØE THRU HOLE MIN. |
|------------|-------------|---------------|------|------|------|------|-------------------|
| FTPPB4VFE4 | 1/4 | 1/4 | 2.14 | 1.61 | 2.18 | 1.25 | .19 |
| FTPPB6VFE4 | 3/8 | 1/4 | 2.26 | 1.73 | 2.18 | 1.25 | .19 |
| FTPPB6VFE6 | 3/8 | 3/8 | 2.26 | 1.73 | 2.21 | 1.28 | .25 |
| FTPPB8VFE6 | 1/2 | 3/8 | 2.34 | 1.8 | 2.21 | 1.28 | .25 |

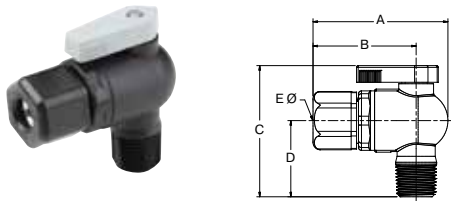

VME - Valve Male Elbow

| PART NO. | 1 TUBE SIZE | NPTF THD SIZE | A | B | C | D | ØE THRU HOLE MIN. |
|------------|-------------|---------------|------|------|------|------|-------------------|
| FTPPB4VME4 | 1/4 | 1/4 | 2.14 | 1.61 | 2.21 | 1.28 | .19 |
| FTPPB6VME4 | 3/8 | 1/4 | 2.26 | 1.73 | 2.21 | 1.28 | .19 |
| FTPPB6VME6 | 3/8 | 3/8 | 2.26 | 1.73 | 2.21 | 1.28 | .25 |
| FTPPB8VME8 | 1/2 | 1/2 | 2.34 | 1.8 | 2.4 | 1.47 | .38 |

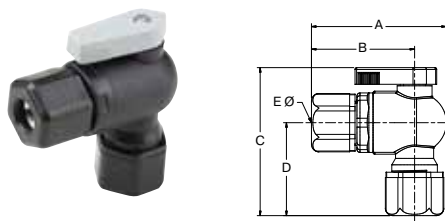

VEU - Valve Elbow Union

| PART NO. | 1 TUBE SIZE | 2 TUBE SIZE | A | B | C | D | ØE THRU HOLE MIN. |
|------------|-------------|-------------|------|------|------|------|-------------------|
| FTPPB4VEU4 | 1/4 | 1/4 | 2.14 | 1.61 | 2.35 | 1.42 | .19 |
| FTPPB6VEU4 | 3/8 | 1/4 | 2.26 | 1.73 | 2.37 | 1.44 | .19 |
| FTPPB6VEU6 | 3/8 | 3/8 | 2.26 | 1.73 | 2.49 | 1.56 | .25 |
| FTPPB8VEU8 | 1/2 | 1/2 | 2.34 | 1.8 | 2.47 | 1.54 | .38 |

WARNING These products can expose you to chemicals including CARBON BLACK, which is known to the state of California to cause cancer. For more information go to www.P65Warnings.ca.gov.



- A
- B
- C
- D
- E
- F
- G
- H
- I
- J
- K
- L
- M
- N
- O

A
B
C
D
E
F
G
H
I
J
K
L
M
N
O



Par-Barb® Fittings

Parker's Par-Barb Fittings are injection molded from high strength chemically inert, thermoplastic materials. The multiple barb design generates the maximum gripping and sealing power when combined with a hose clamp.

Product Features:

- Available in black polypropylene and white nylon
- FDA compliant material
- NSF/ANSI 51
- Uniprene washer
- Up to 1 1/2" sizes

Markets:

- Water
- Beverage Dispensing
- Bottling
- Semi-Conductor

Applications:

- Water
- Beverages
- Cooling Systems
- Vacuum



Specifications:

Pressure Range Up to 125 psi PSI (8.6 bar)

Temperature Range

Nylon: -40° to +200° F (-40° to +93.3° C)

Polypropylene: 0° to +212° F (-12.2° to +100° C)

Compatible Tubing:

- Vinyl
- Polyurethane
- Rubber hose

WARNING These products can expose you to chemicals including NICKEL, CARBON BLACK, TITANIUM DIOXIDE, or LEAD, which are known to the state of California to cause cancer, and LEAD which is known to cause birth defects or other reproductive harm. For more information go to www.P65Warnings.ca.gov.

Threaded Fittings

325HB

Male Connector
NPTF
p. C41



326HB

Female Connector
NPTF
p. C41



372HB

Male Branch Tee
NPTF
p. C42



370HB

Female Elbow
NPTF
p. C42



329HB

Male Elbow
NPTF
p. C42



Tube to Tube Fittings

322HB

Union
p. C40



364HB

Union Tee
p. C40



365HB

Union Elbow
p. C40



362HB

Union Y
p. C42



Pipe Fittings

318P

Hex Plug
p. C40



309P

Bushing
p. C40



316P

Nipple
p. C41



Garden Hose Fittings

316GH

Garden Hose
Adapter
p. C43



325GH

Garden Hose
Connector
p. C43



Accessories

328HB

Hose Barb Stem
p. C43



31HB

Hose Barb
Swivel Nut
p. C43



325GHSV

Swivel Hose
Barb Stem
p. C43



31GH

Garden Hose Nut
p. C43



313GH

Garden Hose Cap
p. C43



30GH

Garden Hose Washer
p. C43



Ball Valves

VFC

Female Connector
p. C44



VFE

Female Elbow
p. C44



VMC

Male Connector
p. C44



VME

Male Elbow
p. C44



VUC

Union Connector
p. C44



VUCPB

Barb x Tuber
p. C44



VEU

Parbarb Elbow
Ball Valve
p. C44



BVC

Ball Valve Clip
p. C44



WARNING These products can expose you to chemicals including NICKEL, CARBON BLACK, TITANIUM DIOXIDE, or LEAD, which are known to the state of California to cause cancer, and LEAD which is known to cause birth defects or other reproductive harm. For more information go to www.P65Warnings.ca.gov.

A
B
C
D
E
F
G
H
I
J
K
L
M
N
O

Click here for CADs, Product Specifications or to Configure Parts Online



Hex Nipple 316P

| WHITE NYLON PART NO. | BLACK POLYPROPYLENE PART NO. | NPT PIPE THREAD SIDE 1 | NPT PIPE THREAD SIDE 2 | C HEX | L | FLOW DIA. D |
|----------------------|------------------------------|------------------------|------------------------|-------|------|-------------|
| 316P-2N | 316P-2PP | 1/8 | 1/8 | 7/16 | .99 | .22 |
| 316P-4-2N | 316P-4-2PP | 1/4 | 1/8 | 9/16 | 1.13 | .22 |
| 316P-4N | 316P-4PP | 1/4 | 1/4 | 9/16 | 1.24 | .31 |
| 316P-6-2N | 316P-6-2PP | 3/8 | 1/8 | 11/16 | 1.11 | .22 |
| 316P-6-4N | 316P-6-4PP | 3/8 | 1/4 | 11/16 | 1.25 | .31 |
| 316P-6N | 316P-6PP | 3/8 | 3/8 | 11/16 | 1.23 | .43 |
| 316P-8-2N | 316P-8-2PP | 1/2 | 1/8 | 7/8 | 1.23 | .22 |
| 316P-8-4N | 316P-8-4PP | 1/2 | 1/4 | 7/8 | 1.36 | .31 |
| 316P-8-6N | 316P-8-6PP | 1/2 | 3/8 | 7/8 | 1.35 | .43 |
| 316P-8N | 316P-8PP | 1/2 | 1/2 | 7/8 | 1.45 | .59 |
| 316P-12-6N | 316P-12-6PP | 3/4 | 3/8 | 1-1/8 | 1.36 | .43 |
| 316P-12-8N | 316P-12-8PP | 3/4 | 1/2 | 1-1/8 | 1.47 | .59 |
| 316P-12N | 316P-12PP | 3/4 | 3/4 | 1-1/8 | 1.48 | .74 |
| 316P-16N | 316P-16PP | 1 | 1 | 1-3/8 | 1.85 | .98 |

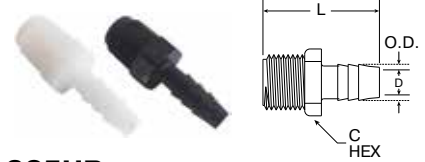

Male Connector 325HB

| WHITE NYLON PART NO. | BLACK POLYPROPYLENE PART NO. | TUBE OR HOSE I.D. | NPT PIPE THD. | O.D. | C HEX | L | FLOW DIA. D |
|----------------------|------------------------------|-------------------|---------------|------|-------|------|-------------|
| 325HB-3-2N | 325HB-3-2PP | 3/16 | 1/8 | .25 | 7/16 | 1.49 | .12 |
| 325HB-3-4N | 325HB-3-4PP | 3/16 | 1/4 | .25 | 9/16 | 1.61 | .13 |
| 325HB-4-2N | 325HB-4-2PP | 1/4 | 1/8 | .31 | 7/16 | 1.50 | .15 |
| 325HB-4-4N | 325HB-4-4PP | 1/4 | 1/4 | .31 | 9/16 | 1.60 | .16 |
| 325HB-4-6N | | 1/4 | 3/8 | .31 | 11/16 | 1.62 | .16 |
| 325HB-4-8N | 325HB-4-8PP | 1/4 | 1/2 | .31 | 7/8 | 1.73 | .15 |
| 325HB-4-12N | | 1/4 | 3/4 | .31 | 1-1/8 | 1.74 | .16 |
| 325HB-5-2N | | 5/16 | 1/8 | .37 | 7/16 | 1.50 | .22 |
| 325HB-5-4N | | 5/16 | 1/4 | .37 | 9/16 | 1.62 | .22 |
| 325HB-5-6N | 325HB-5-6PP | 5/16 | 3/8 | .37 | 11/16 | 1.60 | .21 |
| 325HB-6-2N | 325HB-6-2PP | 3/8 | 1/8 | .43 | 7/16 | 1.49 | .25 |
| 325HB-6-4N | 325HB-6-4PP | 3/8 | 1/4 | .43 | 9/16 | 1.62 | .25 |
| 325HB-6-6N | 325HB-6-6PP | 3/8 | 3/8 | .43 | 11/16 | 1.61 | .25 |
| 325HB-6-8N | 325HB-6-8PP | 3/8 | 1/2 | .43 | 7/8 | 1.73 | .25 |
| 325HB-6-12N | 325HB-6-12PP | 3/8 | 3/4 | .43 | 1-1/8 | 1.72 | .25 |
| 325HB-8-4N | 325HB-8-4PP | 1/2 | 1/4 | .55 | 9/16 | 1.61 | .35 |
| 325HB-8-6N | 325HB-8-6PP | 1/2 | 3/8 | .55 | 11/16 | 1.60 | .37 |
| 325HB-8-8N | 325HB-8-8PP | 1/2 | 1/2 | .55 | 7/8 | 1.73 | .37 |
| 325HB-8-12N | 325HB-8-12PP | 1/2 | 3/4 | .55 | 1-1/8 | 1.72 | .37 |
| 325HB-10-6N | 325HB-10-6PP | 5/8 | 3/8 | .66 | 11/16 | 1.61 | .46 |
| 325HB-10-8N | 325HB-10-8PP | 5/8 | 1/2 | .66 | 7/8 | 1.73 | .46 |
| 325HB-10-12N | 325HB-10-12PP | 5/8 | 3/4 | .67 | 1-1/8 | 1.82 | .46 |
| 325HB-12-8N | 325HB-12-8PP | 3/4 | 1/2 | .80 | 7/8 | 1.86 | .62 |
| 325HB-12-12N | 325HB-12-12PP | 3/4 | 3/4 | .80 | 1-1/8 | 1.85 | .62 |
| 325HB-12-16N | | 3/4 | 1 | .82 | 1-3/8 | 2.35 | .59 |
| 325HB-12-20N | | 3/4 | 1-1/4 | .86 | 1-1/2 | 3.47 | .59 |
| 325HB-12-24N | | 3/4 | 1-1/2 | .86 | 1-3/4 | 3.66 | .59 |
| 325HB-16-8N | | 1 | 1/2 | 1.08 | 1-1/8 | 2.49 | .77 |
| 325HB-16-12N | | 1 | 3/4 | 1.07 | 1-1/8 | 2.30 | .81 |
| 325HB-16-16N | | 1 | 1 | 1.07 | 1-3/8 | 2.35 | .81 |
| 325HB-16-20N | | 1 | 1-1/4 | 1.11 | 1-1/2 | 3.45 | .78 |
| 325HB-16-24N | | 1 | 1-1/2 | 1.11 | 1-3/4 | 3.63 | .78 |
| 325HB-20-20N | | 1-1/4 | 1-1/4 | 1.36 | 1-1/2 | 3.47 | 1.04 |
| 325HB-20-24N | | 1-1/4 | 1-1/2 | 1.36 | 1-3/4 | 3.64 | 1.04 |
| 325HB-24-20N | | 1-1/2 | 1-1/4 | 1.60 | 1-1/2 | 3.45 | 1.28 |
| 325HB-24-24N | | 1-1/2 | 1-1/2 | 1.61 | 1-3/4 | 3.63 | 1.28 |



Female Connector 326HB

| WHITE NYLON PART NO. | BLACK POLYPROPYLENE PART NO. | TUBE OR HOSE I.D. | NPT PIPE THREAD | O.D. | C HEX | L | FLOW DIA. D |
|----------------------|------------------------------|-------------------|-----------------|------|-------|------|-------------|
| 326HB-3-2N | 326HB-3-2PP | 3/16 | 1/8 | .25 | 5/8 | 1.29 | .12 |
| 326HB-3-4N | 326HB-3-4PP | 3/16 | 1/4 | .25 | 3/4 | 1.31 | .13 |
| 326HB-4-2N | 326HB-4-2PP | 1/4 | 1/8 | .31 | 5/8 | 1.51 | .16 |
| 326HB-4-4N | 326HB-4-4PP | 1/4 | 1/4 | .31 | 3/4 | 1.52 | .15 |
| 326HB-4-6N | 326HB-4-6PP | 1/4 | 3/8 | .31 | 1 | 1.73 | .15 |
| 326HB-4-8N | 326HB-4-8PP | 1/4 | 1/2 | .31 | 1-1/8 | 1.74 | .15 |
| 326HB-6-2N | 326HB-6-2PP | 3/8 | 1/8 | .44 | 5/8 | 1.51 | .25 |
| 326HB-6-4N | 326HB-6-4PP | 3/8 | 1/4 | .43 | 3/4 | 1.52 | .25 |
| 326HB-6-6N | 326HB-6-6PP | 3/8 | 3/8 | .43 | 1 | 1.73 | .25 |
| 326HB-6-8N | 326HB-6-8PP | 3/8 | 1/2 | .43 | 1-1/8 | 1.74 | .25 |
| 326HB-8-4N | 326HB-8-4PP | 1/2 | 1/4 | .55 | 3/4 | 1.52 | .37 |
| 326HB-8-6N | 326HB-8-6PP | 1/2 | 3/8 | .55 | 1 | 1.74 | .37 |
| 326HB-8-8N | 326HB-8-8PP | 1/2 | 1/2 | .56 | 1-1/8 | 1.74 | .37 |
| 326HB-10-6N | 326HB-10-6PP | 5/8 | 3/8 | .66 | 1 | 1.61 | .46 |
| 326HB-10-8N | 326HB-10-8PP | 5/8 | 1/2 | .66 | 1-1/8 | 1.73 | .46 |
| 326HB-12-8N | 326HB-12-8PP | 3/4 | 1/2 | .80 | 1-1/8 | 1.86 | .62 |
| 326HB-12-12N | 326HB-12-12PP | 3/4 | 3/4 | .80 | 1-1/8 | 1.85 | .62 |

WARNING These products can expose you to chemicals including NICKEL, CARBON BLACK, TITANIUM DIOXIDE, or LEAD, which are known to the state of California to cause cancer, and LEAD which is known to cause birth defects or other reproductive harm. For more information go to www.P65Warnings.ca.gov.



Click here for CADs, Product Specifications or to Configure Parts Online



Male Branch Tee 372HB

| WHITE NYLON PART NO. | BLACK POLYPROPYLENE PART NO. | TUBE OR HOSE I.D. | NPT PIPE THD. | O.D. | C HEX | L | N | FLOW DIA. D |
|----------------------|------------------------------|-------------------|---------------|------|-------|------|------|-------------|
| 372HB-3-2N | | 3/16 | 1/8 | .25 | 7/16 | 1.94 | 1.06 | .13 |
| 372HB-3-4N | | 3/16 | 1/4 | .24 | 9/16 | 1.93 | 1.17 | .13 |
| 372HB-4-2N | 372HB-4-2PP | 1/4 | 1/8 | .32 | 7/16 | 1.92 | 1.06 | .16 |
| 372HB-4-4N | 372HB-4-4PP | 1/4 | 1/4 | .32 | 9/16 | 1.92 | 1.16 | .16 |
| 372HB-4-6N | 372HB-4-6PP | 1/4 | 3/8 | .32 | 11/16 | 1.92 | 1.18 | .16 |
| 372HB-6-4N | 372HB-6-4PP | 3/8 | 1/4 | .43 | 9/16 | 2.22 | 1.18 | .25 |
| 372HB-6-6N | 372HB-6-6PP | 3/8 | 3/8 | .43 | 11/16 | 2.22 | 1.17 | .25 |
| 372HB-6-8N | 372HB-6-8PP | 3/8 | 1/2 | .43 | 7/8 | 2.22 | 1.29 | .25 |
| 372HB-8-4N | 372HB-8-4PP | 1/2 | 1/4 | .55 | 9/16 | 2.52 | 1.17 | .37 |
| 372HB-8-6N | 372HB-8-6PP | 1/2 | 3/8 | .56 | 11/16 | 2.52 | 1.17 | .37 |
| 372HB-8-8N | 372HB-8-8PP | 1/2 | 1/2 | .55 | 7/8 | 2.52 | 1.30 | .37 |
| 372HB-12-12N | 372HB-12-12PP | 3/4 | 3/4 | .81 | 1-1/8 | 2.97 | 1.92 | .58 |
| 372HB-16-8N | | 1 | 1/2 | 1.07 | 7/8 | 3.10 | 1.74 | .81 |
| 372HB-16-12N | | 1 | 3/4 | 1.07 | 1-1/8 | 3.10 | 1.92 | .81 |
| 372HB-16-16N | | 1 | 1 | 1.07 | 1-3/8 | 3.11 | 1.98 | .81 |



Male Elbow 329HB

| WHITE NYLON PART NO. | BLACK POLYPROPYLENE PART NO. | TUBE OR HOSE I.D. | NPT PIPE THD. | O.D. | C HEX | M | N | FLOW DIA. D |
|----------------------|------------------------------|-------------------|---------------|------|-------|------|------|-------------|
| 329HB-3-2N | 329HB-3-2PP | 3/16 | 1/8 | .25 | 7/16 | .76 | 1.06 | .12 |
| 329HB-3-4N | | 3/16 | 1/4 | .25 | 9/16 | .76 | 1.17 | .13 |
| 329HB-4-2N | 329HB-4-2PP | 1/4 | 1/8 | .31 | 7/16 | 1.18 | 1.04 | .16 |
| 329HB-4-4N | 329HB-4-4PP | 1/4 | 1/4 | .31 | 9/16 | 1.18 | 1.16 | .22 |
| 329HB-4-6N | 329HB-4-6PP | 1/4 | 3/8 | .31 | 11/16 | 1.18 | 1.17 | .15 |
| 329HB-4-8N | 329HB-4-8PP | 1/4 | 1/2 | .32 | 7/8 | 1.18 | 1.30 | .15 |
| 329HB-5-2N | | 5/16 | 1/8 | .37 | 7/16 | 1.18 | 1.06 | .22 |
| 329HB-6-2N | 329HB-6-2PP | 3/8 | 1/8 | .43 | 7/16 | 1.18 | 1.05 | .25 |
| 329HB-6-4N | 329HB-6-4PP | 3/8 | 1/4 | .43 | 9/16 | 1.18 | 1.16 | .25 |
| 329HB-6-6N | 329HB-6-6PP | 3/8 | 3/8 | .43 | 11/16 | 1.17 | 1.17 | .25 |
| 329HB-6-8N | 329HB-6-8PP | 3/8 | 1/2 | .43 | 7/8 | 1.18 | 1.28 | .25 |
| 329HB-8-4N | 329HB-8-4PP | 1/2 | 1/4 | .55 | 9/16 | 1.27 | 1.16 | .37 |
| 329HB-8-6N | 329HB-8-6PP | 1/2 | 3/8 | .56 | 11/16 | 1.26 | 1.16 | .37 |
| 329HB-8-8N | 329HB-8-8PP | 1/2 | 1/2 | .55 | 7/8 | 1.25 | 1.29 | .37 |
| 329HB-8-12N | 329HB-8-12PP | 1/2 | 3/4 | .55 | 1-1/8 | 1.30 | 1.89 | .37 |
| 329HB-10-6N | | 5/8 | 3/8 | .67 | 11/16 | 1.27 | 1.18 | .47 |
| 329HB-10-8N | 329HB-10-8PP | 5/8 | 1/2 | .68 | 7/8 | 1.30 | 1.73 | .48 |
| 329HB-10-12N | 329HB-10-12PP | 5/8 | 3/4 | .69 | 1-1/8 | 1.32 | 1.92 | .49 |
| 329HB-12-8N | 329HB-12-8PP | 3/4 | 1/2 | .81 | 7/8 | 1.51 | 1.74 | .58 |
| 329HB-12-12N | 329HB-12-12PP | 3/4 | 3/4 | .81 | 1-1/8 | 1.50 | 1.91 | .58 |
| 329HB-12-16N | | 3/4 | 1 | .82 | 1-3/8 | 1.49 | 1.98 | .58 |
| 329HB-12-20N | | 3/4 | 1-1/4 | .86 | 1-1/2 | 1.52 | 2.39 | .59 |
| 329HB-12-24N | | 3/4 | 1-1/2 | .85 | 1-1/2 | 2.26 | 3.09 | .59 |
| 329HB-16-8N | | 1 | 1/2 | 1.12 | 7/8 | 1.58 | 1.78 | .86 |
| 329HB-16-12N | | 1 | 3/4 | 1.11 | 1-1/8 | 1.58 | 1.93 | .86 |
| 329HB-16-16N | | 1 | 1 | 1.08 | 1-3/8 | 1.55 | 1.98 | .81 |
| 329HB-16-20N | | 1 | 1-1/4 | 1.12 | 1-1/2 | 2.28 | 2.93 | .84 |
| 329HB-16-24N | | 1 | 1-1/2 | 1.12 | 1-1/2 | 2.27 | 3.11 | .84 |
| 329HB-20-20N | | 1-1/4 | 1-1/4 | 1.25 | 1-1/2 | 2.63 | 2.94 | 1.00 |
| 329HB-20-24N | | 1-1/4 | 1-1/2 | 1.36 | 1-1/2 | 2.63 | 3.11 | 1.08 |
| 329HB-24-20N | | 1-1/2 | 1-1/4 | 1.60 | 1-1/2 | 2.77 | 2.93 | 1.30 |
| 329HB-24-24N | | 1-1/2 | 1-1/2 | 1.60 | 1-1/2 | 2.77 | 3.10 | 1.30 |



Female Elbow 370HB

| WHITE NYLON PART NO. | BLACK POLYPROPYLENE PART NO. | TUBE OR HOSE I.D. | NPT PIPE THD. | O.D. | C HEX | M | N | FLOW DIA. D |
|----------------------|------------------------------|-------------------|---------------|------|-------|------|------|-------------|
| 370HB-4-2N | 370HB-4-2PP | 1/4 | 1/8 | .31 | 5/8 | 1.19 | 1.07 | .16 |
| 370HB-4-4N | 370HB-4-4PP | 1/4 | 1/4 | .31 | 3/4 | 1.18 | 1.08 | .16 |
| 370HB-4-6N | 370HB-4-6PP | 1/4 | 3/8 | .31 | 1 | 1.16 | 1.30 | .16 |
| 370HB-4-8N | 370HB-4-8PP | 1/4 | 1/2 | .31 | 1-1/8 | 1.18 | 1.30 | .15 |
| 370HB-6-2N | 370HB-6-2PP | 3/8 | 1/8 | .43 | 5/8 | 1.18 | 1.06 | .25 |
| 370HB-6-4N | 370HB-6-4PP | 3/8 | 1/4 | .44 | 3/4 | 1.18 | 1.06 | .25 |
| 370HB-6-6N | 370HB-6-6PP | 3/8 | 3/8 | .43 | 1 | 1.18 | 1.29 | .25 |
| 370HB-6-8N | 370HB-6-8PP | 3/8 | 1/2 | .43 | 1-1/8 | 1.18 | 1.29 | .25 |
| 370HB-8-4N | 370HB-8-4PP | 1/2 | 1/4 | .55 | 3/4 | 1.25 | 1.22 | .37 |
| 370HB-8-6N | 370HB-8-6PP | 1/2 | 3/8 | .55 | 1 | 1.25 | 1.44 | .37 |
| 370HB-8-8N | 370HB-8-8PP | 1/2 | 1/2 | .55 | 1-1/8 | 1.25 | 1.45 | .37 |
| 370HB-8-12N | 370HB-8-12PP | 1/2 | 3/4 | .55 | 1-3/8 | 1.26 | 1.72 | .37 |
| 370HB-12-12N | 370HB-12-12PP | 3/4 | 3/4 | .80 | 1-3/8 | 1.38 | 1.84 | .59 |

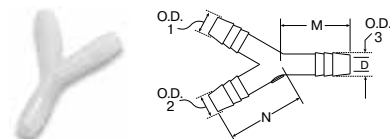

Union Y 362HB

| WHITE NYLON PART NO. | TUBE OR HOSE I.D. 1 & 2 | TUBE OR HOSE I.D. 3 | O.D. 1 & 2 | O.D. 3 | M | N | FLOW DIA. D |
|----------------------|-------------------------|---------------------|------------|--------|------|------|-------------|
| 362HB-4N | 1/4 | 1/4 | .31 | .31 | 1.13 | 1.13 | .16 |
| 362HB-6N | 3/8 | 3/8 | .43 | .43 | 1.25 | 1.40 | .25 |
| 362HB-8N | 1/2 | 1/2 | .55 | .55 | 1.25 | 1.50 | .38 |

WARNING These products can expose you to chemicals including NICKEL, CARBON BLACK, TITANIUM DIOXIDE, or LEAD, which are known to the state of California to cause cancer, and LEAD which is known to cause birth defects or other reproductive harm. For more information go to www.P65Warnings.ca.gov.



Click here for CADs, Product Specifications or to Configure Parts Online



Ball Nose Hose Barb Stem 328HB

| WHITE NYLON PART NO. | BLACK POLYPROPYLENE PART NO. | TUBE OR HOSE I.D. | SWIVEL NUT NPT PIPE THREAD | O.D. | L | FLOW DIA. D |
|----------------------|------------------------------|-------------------|----------------------------|------|------|-------------|
| 328HB-4BN | 328HB-4BPP | 1/4 | 1/4 * | .30 | 1.19 | .19 |
| 328HB-4-8BN | 328HB-4-8BPP | 1/4 | 1/2 * | .30 | 1.29 | .15 |
| 328HB-6BN | 328HB-6BPP | 3/8 | 3/8 * | .56 | 1.41 | .25 |
| 328HB-8BN | 328HB-8BPP | 1/2 | 1/2 * | .67 | 1.30 | .37 |

*Use with hose barb swivel nut (31HB-XX) for desired NPT thread.



Hose Barb Swivel Nut 31HB

| WHITE NYLON PART NO. | BLACK POLYPROPYLENE PART NO. | NPT PIPE THREAD | C HEX | L |
|----------------------|------------------------------|-----------------|---------|-----|
| 31HB-4N | 31HB-4PP | 1/4 | 3/4 | .62 |
| 31HB-6N | 31HB-6PP | 3/8 | 7/8 | .63 |
| 31HB-8N | 31HB-8PP | 1/2 | 1- 1/16 | .75 |

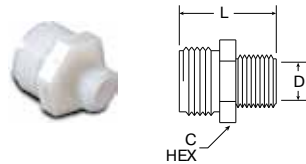

Male Garden Hose - Male Pipe Adapter 316GH

| WHITE NYLON PART NO. | GARDEN HOSE THREAD | NPT PIPE THREAD | C HEX | L | FLOW DIA. D |
|----------------------|--------------------|-----------------|--------|------|-------------|
| 316GH-12-6N | 3/4 | 3/8 | 1- 1/8 | 1.33 | .44 |
| 316GH-12-8N | 3/4 | 1/2 | 1- 1/8 | 1.44 | .59 |
| 316GH-12-12N | 3/4 | 3/4 | 1- 1/8 | 1.48 | .75 |

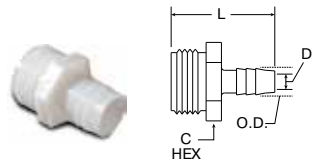

Male Garden Hose - Hose Barb 325GH

| WHITE NYLON PART NO. | TUBE OR HOSE I.D. | GARDEN HOSE THREAD | O.D. | C HEX | L | FLOW DIA. D |
|----------------------|-------------------|--------------------|------|--------|------|-------------|
| 325GH-4-12N | 1/4 | 3/4 | .31 | 1- 1/8 | 1.70 | .16 |
| 325GH-6-12N | 3/8 | 3/4 | .44 | 1- 1/8 | 1.69 | .25 |
| 325GH-8-12N | 1/2 | 3/4 | .55 | 1- 1/8 | 1.68 | .38 |
| 325GH-10-12N | 5/8 | 3/4 | .64 | 1- 1/8 | 1.70 | .47 |
| 325GH-12-12N | 3/4 | 3/4 | .81 | 1- 1/8 | 1.70 | .62 |

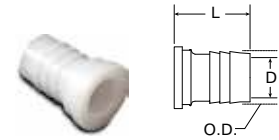

Garden Hose Swivel Hose Barb Stem 325GHSV

| WHITE NYLON PART NO. | TUBE OR HOSE I.D. | GARDEN HOSE THREAD | O.D. | L | FLOW DIA. D |
|----------------------|-------------------|--------------------|------|------|-------------|
| 325GHSV-4-12BN* | 1/4 | 3/4 | .31 | 1.16 | .16 |
| 325GHSV-6-12BN* | 3/8 | 3/4 | .44 | 1.17 | .25 |
| 325GHSV-8-12BN* | 1/2 | 3/4 | .56 | 1.17 | .38 |
| 325GHSV-10-12BN* | 5/8 | 3/4 | .64 | 1.18 | .47 |
| 325GHSV-12-12BN* | 3/4 | 3/4 | .81 | 1.18 | .62 |

*Use with Garden Hose washer (30GH-12) and Garden Hose Nut (31GH-12N)



Garden Hose Nut 31GH

| WHITE NYLON PART NO. | GARDEN HOSE THREAD | L | DIA. N |
|----------------------|--------------------|-----|--------|
| 31GH-12N | 3/4 | .74 | 1.38 |



Garden Hose Cap 313GH

| WHITE NYLON PART NO. | GARDEN HOSE THREAD | L | DIA. N |
|----------------------|--------------------|-----|--------|
| 313GH-12N** | 3/4 | .74 | 1.38 |

**Use with Garden Hose Washer (30GH-12)



Garden Hose Washer 30GH

| WHITE TPE PART NO. | GARDEN HOSE THREAD | L |
|--------------------|--------------------|-----|
| 30GH-12 | 3/4 | .13 |

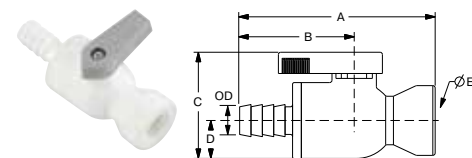

VFC - Valve Barbed Female Connector

| PART NO. | HOSE I.D. | NPTF THD. | O.D. | A | B | C | D | ØE THRU HOLE MIN. |
|-----------|-----------|-----------|------|------|------|------|-----|-------------------|
| PBPP4VFC4 | 1/4 | 1/4 | .31 | 2.76 | 1.60 | 1.41 | .50 | .15 |
| PBPP6VFC6 | 3/8 | 3/8 | .43 | 2.79 | 1.60 | 1.41 | .50 | .19 |

WARNING These products can expose you to chemicals including NICKEL, CARBON BLACK, TITANIUM DIOXIDE, or LEAD, which are known to the state of California to cause cancer, and LEAD which is known to cause birth defects or other reproductive harm. For more information go to www.P65Warnings.ca.gov.



[Click here for CADs, Product Specifications or to Configure Parts Online](#)

- A
- B
- C
- D
- E
- F
- G
- H
- I
- J
- K
- L
- M
- N
- O

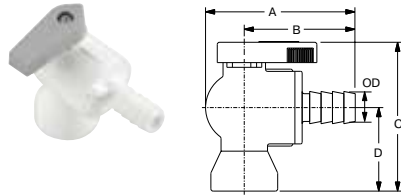

VFE - Valve Barbed Female Elbow

| PART NO. | HOSE I.D. | NPTF THD. | O.D. | A | B | C | D | ØE THRU HOLE MIN. |
|-----------|-----------|-----------|------|------|------|------|------|-------------------|
| PBPP4VFE4 | 1/4 | 1/4 | .31 | 2.13 | 1.60 | 2.05 | 1.15 | .15 |
| PBPP6VFE4 | 3/8 | 1/4 | .43 | 2.13 | 1.60 | 2.05 | 1.15 | .15 |
| PBPP6VFE6 | 3/8 | 3/8 | .43 | 2.13 | 1.60 | 2.18 | 1.28 | .19 |

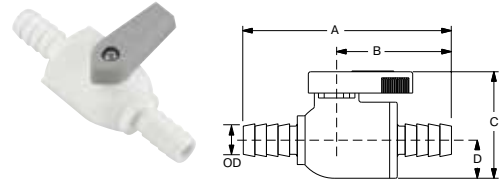

VUC - Valve Barbed Union Connector

| PART NO. | HOSE I.D. | O.D. | A | B | C | D | ØE THRU HOLE MIN. |
|-----------|-----------|------|------|------|------|-----|-------------------|
| PBPP4VUC4 | 1/4 | .31 | 2.91 | 1.60 | 1.42 | .50 | .15 |
| PBPP6VUC6 | 3/8 | .43 | 2.91 | 1.60 | 1.42 | .50 | .19 |
| PBPP8VUC8 | 1/2 | .55 | 2.91 | 1.60 | 1.42 | .50 | .25 |

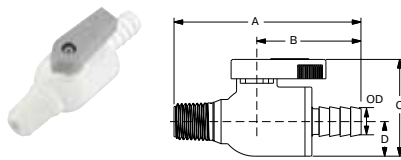

VMC - Valve Barbed Male Connector

| PART NO. | HOSE I.D. | NPTF THD. | O.D. | A | B | C | D | ØE THRU HOLE MIN. |
|-----------|-----------|-----------|------|------|------|------|-----|-------------------|
| PBPP4VMC4 | 1/4 | 1/4 | .31 | 2.79 | 1.60 | 1.42 | .50 | .15 |
| PBPP6VMC6 | 3/8 | 3/8 | .43 | 2.79 | 1.60 | 1.42 | .50 | .19 |

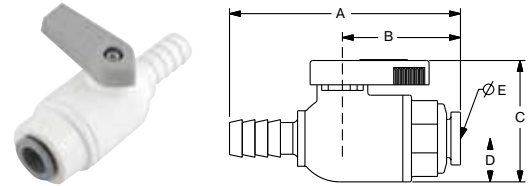

VUCPB - Valve Union Connector Barbed x Tube

| PART NO. | HOSE ID | TUBE OD | OD | A | B | C | D | ØE THRU HOLE MIN. |
|-------------|---------|---------|-----|------|------|------|-----|-------------------|
| LFPP4VUCPB4 | 1/4 | 1/4 | .31 | 2.40 | 1.08 | 1.42 | .50 | .15 |
| LFPP6VUCPB6 | 3/8 | 3/8 | .43 | 2.63 | 1.32 | 1.42 | .50 | .19 |

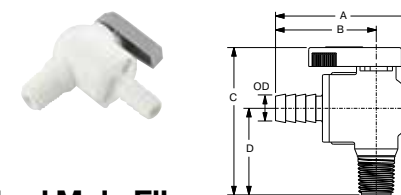

VME - Valve Barbed Male Elbow

| PART NO. | HOSE I.D. | NPTF THD. | O.D. | A | B | C | D | ØE THRU HOLE MIN. |
|-----------|-----------|-----------|------|------|------|------|------|-------------------|
| PBPP4VME4 | 1/4 | 1/4 | .31 | 2.13 | 1.60 | 2.18 | 1.28 | .15 |
| PBPP6VME6 | 3/8 | 3/8 | .43 | 2.13 | 1.60 | 2.18 | 1.28 | .19 |

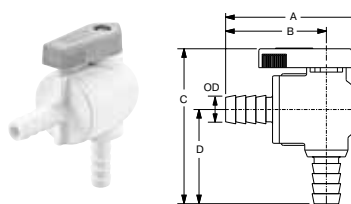

VEU - Parbarb Elbow Ball Valve

| PART NO. | HOSE I.D. | O.D. | A | B | C | D | ØE THRU HOLE MIN. |
|-----------|-----------|------|------|------|------|------|-------------------|
| PBPP4VEU4 | 1/4 | .31 | 2.13 | 1.57 | 2.32 | 1.40 | .15 |
| PBPP6VEU6 | 3/8 | .43 | 2.13 | 1.60 | 2.32 | 1.40 | .25 |
| PBPP8VEU8 | 1/2 | .55 | 2.13 | 1.60 | 2.32 | 1.40 | .25 |

BVC Ball Valve Clip

BV-Clip Shown below holding VUCPB and VME

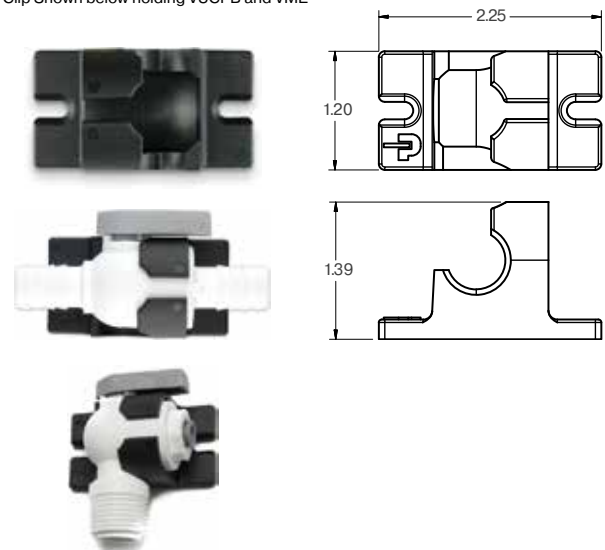

WARNING These products can expose you to chemicals including NICKEL, CARBON BLACK, TITANIUM DIOXIDE, or LEAD, which are known to the state of California to cause cancer, and LEAD which is known to cause birth defects or other reproductive harm. For more information go to www.P65Warnings.ca.gov.





Cartridges

Carstick® Cartridges

LIQUIfit® Cartridges

TrueSeal™ Cartridges

PLM/PLS Cartridges

SAE Encapsulated Cartridges





- A
- B
- C
- D
- E
- F
- G
- H
- I
- J
- K
- L
- M
- N
- O



Cartridges

Parker has developed a range of cartridges guaranteeing the integrity of the sealing system before and after assembly in non-threaded cavities. The compact design of the one-piece cartridges enables automation of your manufacturing process and improves the reliability of your system.

Product Features:

- Self-centering of the cartridge in the cavity
- Push-in connection
- Designed for automation assembly process
- SAE & NSF cartridges available

Markets:

- Industrial
- Pneumatic
- Filtration
- Semi-Conductor
- Life Science
- Automation
- Heavy Duty Truck

Applications:

- Air
- Water
- Beverage Dispensing
- Cab Controls
- Packaging
- Labeling
- Vacuum

Specifications:

| | Seals | Pressure | Temperature |
|-----------------|---------|--------------------------|--------------------------------------|
| Carstick | Nitrile | Up to 290 PSI (20 bar) | -4° to +175° F (-20° to +79.4° C) |
| PLM/PLS | FKM | Up to 435 PSI (30 bar) | -13° to +302° F (-25° to +150° C) |
| LIQUIfit | EPDM | Up to 230 PSI (15.9 bar) | 35° to +200° F (+1.7° to +93.3° C) |
| TrueSeal | EPDM | Up to 150 PSI (10.3 bar) | -20° to +180° F (-28.9° to +82.2° C) |
| PTC | Nitrile | Up to 250 PSI (17.2 bar) | -40° to +200° F (-40° to +93.3° C) |

WARNING These products can expose you to chemicals including NICKEL or LEAD, which are known to the state of California to cause cancer, and LEAD which is known to cause birth defects or other reproductive harm. For more information go to www.P65Warnings.ca.gov.



■ Carstick Cartridges

3100
Carstick® Cartridge
Brass
p. D6



3100
Carstick® Cartridge
Nickel-Plated Brass
p. D6



■ Liquifit Cartridges

6300
LIQUIfit Cartridge
Brass
p. D8



6300
LIQUIfit Cartridge
Nickel-Plated Brass
p. D8



■ TrueSeal Cartridges

TSC
Cartridge Insert
p. D10



■ PLM/PLS Cartridges

PLMC
Cartridge
p. D11



PLSC
Cartridge
p. D11



■ SAE Encapsulated Cartridges

PTCCE
Encapsulated
p. D12



⚠ WARNING These products can expose you to chemicals including NICKEL or LEAD, which are known to the state of California to cause cancer, and LEAD which is known to cause birth defects or other reproductive harm. For more information go to www.P65Warnings.ca.gov.



- A
- B
- C
- D**
- E
- F
- G
- H
- I
- J
- K
- L
- M
- N
- O

Click here for CADs, Product Specifications or to Configure Parts Online

Carstick® Cartridges

Component Materials

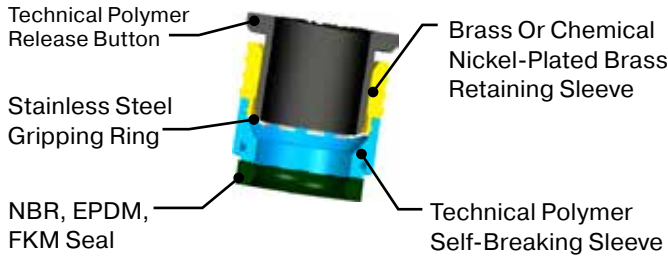

3100 Carstick® Cartridge Brass

| PART NO. | OD | G | G1 | H | L | KG |
|------------|----|------|------|------|------|------|
| 3100 04 00 | 4 | 8 | 11 | 10 | 554 | .001 |
| 3100 06 00 | 6 | 10 | 14.5 | 11.5 | 629 | .002 |
| 3100 08 00 | 8 | 13 | 15 | 15 | 794 | .002 |
| 3100 10 00 | 10 | 15.5 | 19.5 | 17 | 930 | .005 |
| 3100 12 00 | 12 | 19.5 | 21 | 19.5 | 1038 | .010 |

50 cartridges per Carstick®

3100 Carstick® Cartridge Nickel-Plated Brass Inch

| PART NO. | OD | G | G1 | H | L | KG |
|---------------|-----|------|------|------|-----|------|
| 3100 53 00 99 | 1/8 | 7 | 10 | 9 | 508 | .002 |
| 3100 56 00 99 | 1/4 | 10.5 | 14.5 | 12 | 600 | .003 |
| 3100 60 00 99 | 3/8 | 15.5 | 19 | 16.5 | 930 | .006 |

50 cartridges per Carstick®
5/32" (4mm) and 5/16" (8mm) also available

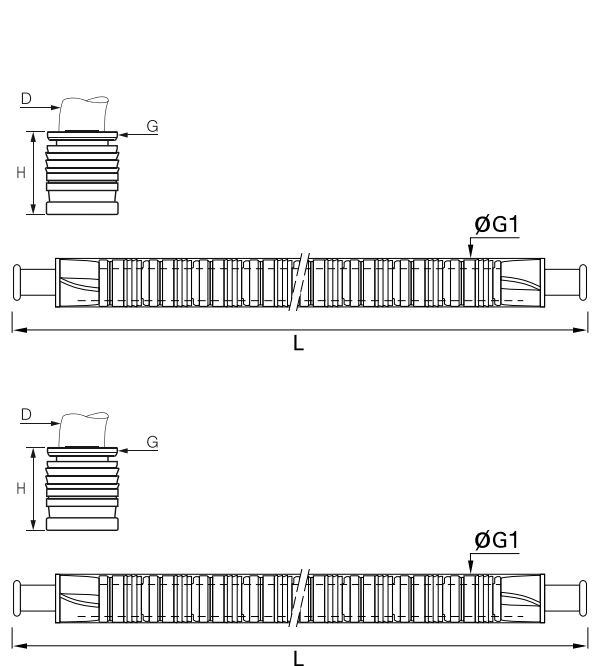

Installation

1. Self-centering of the cartridge in the cavity.
2. The seal protection is broken. The seal slides into the cavity. The cartridge is in place.
3. Tube connection.

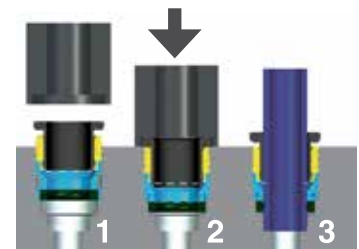

Assembly Tool: For details on the assembly tool, please contact us.

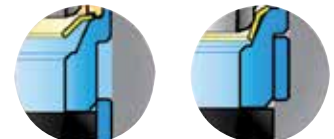

WARNING These products can expose you to chemicals including NICKEL or LEAD, which are known to the state of California to cause cancer, and LEAD which is known to cause birth defects or other reproductive harm. For more information go to www.P65Warnings.ca.gov.

[Click here for CADs, Product Specifications or to Configure Parts Online](#)

Carstick® Cavity Dimensions

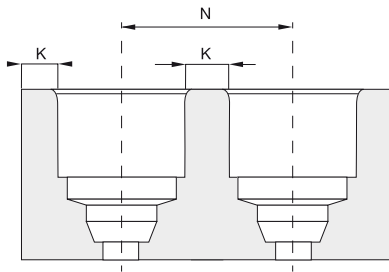
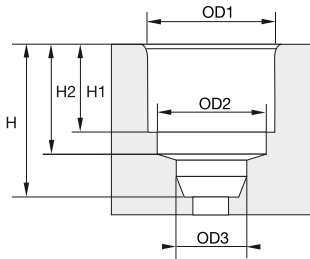

Please consult us for detailed drawings of cavity dimensions and tolerances. All our dimensions are in millimeters.

Carstick® & Quick Fitting Metric

| CAVITY | OD3 | H | H1 | H2 |
|--------|-------|------|------|-------|
| 4 | 4.1 | 10 | 6 | 8.15 |
| 6 | 6.1 | 12 | 7.5 | 9.65 |
| 8 | 8.15 | 15.5 | 9.9 | 12.45 |
| 10 | 10.25 | 19 | 11.7 | 14.35 |
| 12 | 12.17 | 22 | 13.9 | 16.75 |

Carstick® Inch

| CAVITY | OD3 | H | H1 | H2 |
|--------|------|-------|------|------|
| 1/8 | 3.25 | 7.45 | 5.3 | 9.5 |
| 5/32 * | 4.1 | 8.15 | 6 | 10 |
| 1/4 | 6.45 | 10.15 | 8 | 12.5 |
| 5/16 * | 8.15 | 12.45 | 9.9 | 15.5 |
| 3/8 | 9.65 | 14.35 | 11.7 | 19 |
| 1/2 | 12.8 | 26.1 | 16.9 | 20.1 |

Polyamide Cavity

| CAVITY | OD1 | OD2 | N* | K |
|--------|-------|-------|------|-----|
| 4 | 8.25 | 7.05 | 9.8 | 1.5 |
| 6 | 10.2 | 9.15 | 12.2 | 2 |
| 8 | 12.15 | 10.85 | 14.2 | 2 |
| 10 | 14.8 | 13.2 | 16.8 | 2 |
| 12 | 17.5 | 15.5 | 20 | 2.5 |

| CAVITY | OD1 | OD2 | N | K |
|--------|-------|-------|-------|-----|
| 1/8 | 7.05 | 6.02 | 8.6 | 1.5 |
| 5/32* | 8.25 | 7.05 | 9.75 | 1.5 |
| 1/4 | 10.55 | 9.35 | 12.6 | 2 |
| 5/16* | 12.15 | 10.85 | 14.2 | 2 |
| 3/8 | 14.8 | 13.1 | 16.8 | 2 |
| 1/2 | 19.86 | 17.82 | 24.85 | 2.5 |

Aluminum Cavity

| CAVITY | OD1 | OD2 | N* | K |
|--------|-------|-------|------|-----|
| 4 | 8.25 | 7.5 | 11.5 | 3 |
| 6 | 10.3 | 9.15 | 13.5 | 3 |
| 8 | 12.2 | 10.85 | 15.2 | 3 |
| 10 | 15.05 | 13.2 | 17.1 | 2 |
| 12 | 17.5 | 15.5 | 20 | 2.5 |

| CAVITY | OD1 | OD2 | N | K |
|--------|-------|-------|-------|-----|
| 1/8 | 7.1 | 6.2 | 8.6 | 1.5 |
| 5/32* | 8.25 | 7.05 | 11.25 | 3 |
| 1/4 | 10.6 | 9.35 | 12.65 | 2 |
| 5/16* | 12.2 | 10.85 | 15.2 | 3 |
| 3/8 | 15.05 | 13.1 | 17.1 | 2 |

Brass Cavity

| CAVITY | OD1 | OD2 | N* | K |
|--------|-------|-------|-------|-----|
| 4 | 8.25 | 7.05 | 10.25 | 2 |
| 6 | 10.25 | 9.1 | 12.25 | 2 |
| 8 | 12.2 | 10.85 | 14.25 | 2 |
| 10 | 15.05 | 13.2 | 17.1 | 2 |
| 12 | 17.65 | 15.5 | 20 | 2.5 |

| CAVITY | OD1 | OD2 | N | K |
|--------|-------|-------|-------|-----|
| 1/8 | 7.1 | 6.2 | 8.6 | 1.5 |
| 5/32* | 8.25 | 7.05 | 10.25 | 2 |
| 1/4 | 10.6 | 9.35 | 12.65 | 2 |
| 5/16* | 12/2 | 10.85 | 14.25 | 2 |
| 3/8 | 10.05 | 13.1 | 17.1 | 2 |

* Carstick®

*5/32"=4mm and 5/16"=8mm

WARNING These products can expose you to chemicals including NICKEL or LEAD, which are known to the state of California to cause cancer, and LEAD which is known to cause birth defects or other reproductive harm. For more information go to www.P65Warnings.ca.gov.



- A
- B
- C
- D
- E
- F
- G
- H
- I
- J
- K
- L
- M
- N
- O

Click here for CADs, Product Specifications or to Configure Parts Online

LIQUIfit® Cartridges

- A
- B
- C
- D
- E
- F
- G
- H
- I
- J
- K
- L
- M
- N
- O



6300 LIQUIfit Cartridge Brass Metric

| PART NO. | OD | G | G1 | H | L | KG |
|------------|----|------|------|------|------|------|
| 6300 04 00 | 4 | 8 | 11 | 10 | 554 | .002 |
| 6300 06 00 | 6 | 10 | 14.5 | 11.5 | 629 | .002 |
| 6300 08 00 | 8 | 13 | 15 | 15 | 794 | .003 |
| 6300 10 00 | 10 | 15.5 | 19.5 | 17 | 930 | .005 |
| 6300 12 00 | 12 | 18.5 | 21 | 19.5 | 1038 | .010 |

50 cartridges per Carstick®

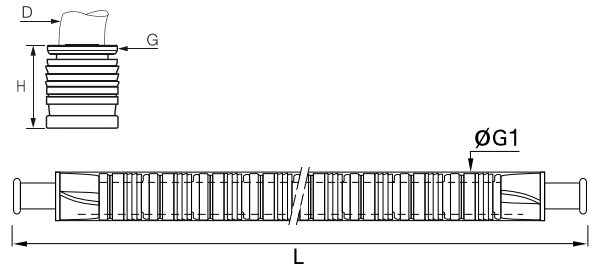

6300 LIQUIfit Cartridge Brass Inch

| PART NO. | OD | G | G1 | H | L | KG |
|------------|-----|------|------|------|------|------|
| 6300 56 00 | 1/4 | 10.5 | 14.5 | 12.5 | 600 | .002 |
| 6300 60 00 | 3/8 | 15.5 | 19 | 17 | 930 | .005 |
| 6300 62 00 | 1/2 | 22 | 25 | 23 | 1038 | .011 |

50 cartridges per Carstick®
5/32" (4mm) and 5/16" (8mm) also available

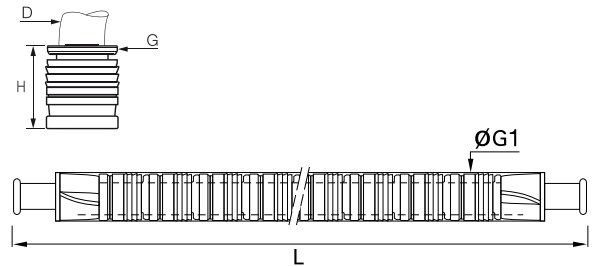

Installation

1. Self-centering of the cartridge in the cavity.
2. The seal protection is broken. The seal slides into the cavity. The cartridge is in place.
3. Tube connection.

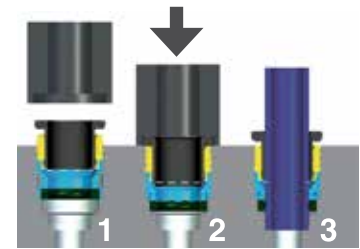

 Assembly Tool: For details on the assembly tool, please contact us.



WARNING These products can expose you to chemicals including NICKEL or LEAD, which are known to the state of California to cause cancer, and LEAD which is known to cause birth defects or other reproductive harm. For more information go to www.P65Warnings.ca.gov.



[Click here for CADs, Product Specifications or to Configure Parts Online](#)

LIQUIft® Carstick® Cavity Dimensions

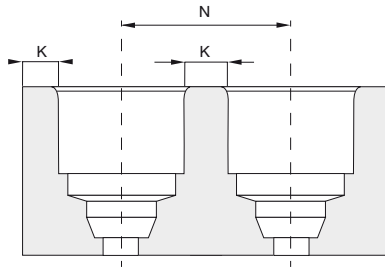
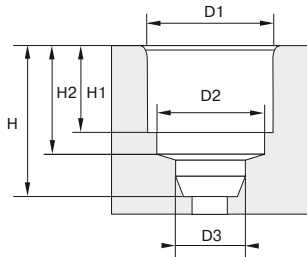

Please consult us for detailed drawings of cavity dimensions and tolerances. All our dimensions are in millimeters.

LIQUIft® Carstick® Metric

| CAVITY | OD3 | H | H1 | H2 |
|--------|-------|------|------|-------|
| 4 | 4.1 | 10 | 6 | 8.15 |
| 6 | 6.1 | 12 | 7.5 | 9.65 |
| 8 | 8.15 | 15.5 | 9.9 | 12.45 |
| 10 | 10.25 | 19 | 11.7 | 14.35 |
| 12 | 12.17 | 22 | 13.9 | 16.75 |

LIQUIft® Carstick® Inch

| CAVITY | OD3 | H | H1 | H2 |
|--------|------|-------|------|------|
| 1/8 | 3.25 | 7.45 | 5.3 | 9.5 |
| 5/32* | 4.1 | 8.15 | 6 | 10 |
| 1/4 | 6.45 | 10.15 | 8 | 12.5 |
| 5/16* | 8.15 | 12.45 | 9.9 | 15.5 |
| 3/8 | 9.65 | 14.35 | 11.7 | 19 |

Polyamide Cavity

| CAVITY | OD1 | OD2 | N* | K |
|--------|-------|-------|------|-----|
| 4 | 8.25 | 7.05 | 9.8 | 1.5 |
| 6 | 10.2 | 9.15 | 12.2 | 2 |
| 8 | 12.15 | 10.85 | 14.2 | 2 |
| 10 | 14.8 | 13.2 | 16.8 | 2 |
| 12 | 17.5 | 15.5 | 20 | 2.5 |

| CAVITY | OD1 | OD2 | N | K |
|--------|-------|-------|------|-----|
| 1/8 | 7.05 | 6.02 | 8.6 | 1.5 |
| 5/32* | 8.25 | 7.05 | 9.75 | 1.5 |
| 1/4 | 10.55 | 9.35 | 12.6 | 2 |
| 5/16* | 12.15 | 10.85 | 14.2 | 2 |
| 3/8 | 14.8 | 13.1 | 16.8 | 2 |

Aluminum Cavity

| CAVITY | OD1 | OD2 | N* | K |
|--------|-------|-------|------|-----|
| 4 | 8.25 | 7.5 | 11.5 | 3 |
| 6 | 10.3 | 9.15 | 13.5 | 3 |
| 8 | 12.2 | 10.85 | 15.2 | 3 |
| 10 | 15.05 | 13.2 | 17.1 | 2 |
| 12 | 17.5 | 15.5 | 20 | 2.5 |

| CAVITY | OD1 | OD2 | N | K |
|--------|-------|-------|-------|-----|
| 1/8 | 7.1 | 6.2 | 8.6 | 1.5 |
| 5/32* | 8.25 | 7.05 | 11.25 | 3 |
| 1/4 | 10.6 | 9.35 | 12.65 | 2 |
| 5/16* | 12.2 | 10.85 | 15.2 | 3 |
| 3/8 | 15.05 | 13.1 | 17.1 | 2 |

Brass Cavity

| CAVITY | OD1 | OD2 | N* | K |
|--------|-------|-------|-------|-----|
| 4 | 8.25 | 7.05 | 10.25 | 2 |
| 6 | 10.25 | 9.1 | 12.25 | 2 |
| 8 | 12.2 | 10.85 | 14.25 | 2 |
| 10 | 15.05 | 13.2 | 17.1 | 2 |
| 12 | 17.65 | 15.5 | 20 | 2.5 |

| CAVITY | OD1 | OD2 | N | K |
|--------|-------|-------|-------|-----|
| 1/8 | 7.1 | 6.2 | 8.6 | 1.5 |
| 5/32* | 8.25 | 7.05 | 10.25 | 2 |
| 1/4 | 10.6 | 9.35 | 12.65 | 2 |
| 5/16* | 12.2 | 10.85 | 14.25 | 2 |
| 3/8 | 10.05 | 13.1 | 17.1 | 2 |

*5/32"=4mm and 5/16"=8mm

WARNING These products can expose you to chemicals including NICKEL or LEAD, which are known to the state of California to cause cancer, and LEAD which is known to cause birth defects or other reproductive harm. For more information go to www.P65Warnings.ca.gov.



- A
- B
- C
- D
- E
- F
- G
- H
- I
- J
- K
- L
- M
- N
- O

[Click here for CADs, Product Specifications or to Configure Parts Online](#)

TrueSeal™ Cartridges



TSC - Cartridge Insert

| PART NUMBER WITH EPDM SEAL | NOM. TUBE O.D. | A* DIAMETER ±002 | B DIAMETER ±003 | C DIAMETER ±003 | D DIAMETER MAXIMUM | E DEPTH ±002 | F DEPTH ±002 | G DEPTH ±002 | H* CENTERLINE OF PORTS MINIMUM |
|----------------------------|----------------|------------------|-----------------|-----------------|--------------------|--------------|--------------|--------------|--------------------------------|
| ATSC4-MG | 1/4 | .528 | .421 | .260 | .19 | .230 | .435 | .600 | .670 |
| ATSC6-MG | 3/8 | .632 | .545 | .385 | .31 | .280 | .455 | .705 | .790 |
| ATSC8-MG | 1/2 | .774 | .668 | .510 | .41 | .315 | .510 | .810 | 1.250 |

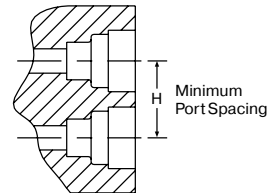
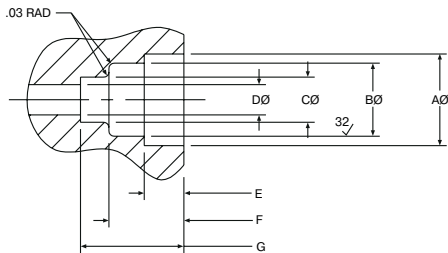

Parker TrueSeal™ Cartridge Inserts:

Allow you to machine or mold a tube connection into your equipment or components. By using cartridge inserts, you will reduce your material and assembly costs, reduce potential leak paths, and give your equipment a new, clean profile by eliminating the need for threaded connections. TSC Cartridge Inserts consist of 1 o-ring, 1 cartridge, and 1 collet.

*Cartridge inserts are rated at 150 PSI in ports dimensioned as above and having Noryl as the receiving material. Other materials may have different ratings and require different port dimensions. Consult the Fluid System Connectors Division when using polypropylene, unfilled polypropylene, ABS or Nylon.

Assembly Instructions:

1. Machine or mold the receiving orifice as per the above dimensions.
2. Place the cartridge insert squarely onto the prepared port opening making sure that the barbs of the cartridge are going into the hole and the lettering on the face of the cartridge is visible.
3. Using a rubber mallet or press, insert the cartridge into the first gland orifice until its face is flush with the top surface of the port.
4. Insert the o-ring into the cartridge and seat it evenly into the second gland orifice.
5. Insert the collet into the cartridge opening.
6. Insert tubing.

WARNING These products can expose you to chemicals including NICKEL or LEAD, which are known to the state of California to cause cancer, and LEAD which is known to cause birth defects or other reproductive harm. For more information go to www.P65Warnings.ca.gov.



[Click here for CADs, Product Specifications or to Configure Parts Online](#)

PLM/PLS Cartridges

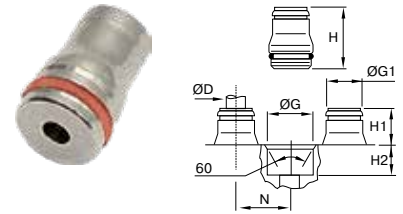
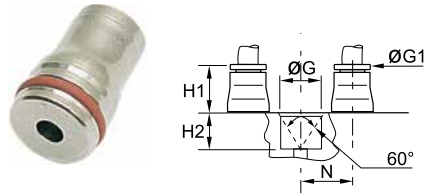

PLMC Cartridge

| PART NO. | TUBE SIZE MM | G + .1 - 0 | H1 MM | H2 MM | N MM |
|----------|-----------------|---------------|----------|----------|---------|
| PLMC-4M | 4 | 10.00 | 9.00 | 8.50 | 11.00 |
| PLMC-6M | 6 | 12.00 | 11.00 | 8.50 | 13.50 |
| PLMC-8M | 8 | 15.00 | 12.50 | 8.50 | 16.00 |
| PLMC-10M | 10 | 17.50 | 14.50 | 10.50 | 20.00 |
| PLMC-12M | 12 | 19.50 | 15.00 | 10.50 | 22.50 |
| PLMC-14M | 14 | 21.50 | 16.50 | 12.00 | 25.00 |

PLSC Cartridge - Metric

| PART NO. | TUBE SIZE MM | G + .1 - 0 MM | G1 MM | H MM | H1 MM | H2 MM | N MM |
|----------|-----------------|---------------------|----------|---------|----------|----------|---------|
| PLSC-4M | 4 | 9.80 | 8 | 18.00 | 9.50 | 8.50 | 11.00 |
| PLSC-6M | 6 | 12.10 | 10 | 20.00 | 11.50 | 8.50 | 13.50 |
| PLSC-8M | 8 | 14.80 | 13 | 22.00 | 13.50 | 8.50 | 16.00 |
| PLSC-10M | 10 | 17.50 | 15 | 25.50 | 15.00 | 10.50 | 20.00 |

WARNING These products can expose you to chemicals including NICKEL or LEAD, which are known to the state of California to cause cancer, and LEAD which is known to cause birth defects or other reproductive harm. For more information go to www.P65Warnings.ca.gov.



- A
- B
- C
- D
- E
- F
- G
- H
- I
- J
- K
- L
- M
- N
- O

[Click here for CADs, Product Specifications or to Configure Parts Online](#)

SAE Encapsulated Cartridges

PTCCE SAE Encapsulated Cartridge

| PART NO. | TUBE SIZE | CAVITY SIZE ±.002 | L | M | O.D. | FLOW DIA. D |
|-----------|-----------|-------------------|-----|-----|------|-------------|
| PTCCE-4 | 1/4 | .504 | .63 | .43 | .56 | .13 |
| PTCCE-4-8 | 1/4 | .775 | .63 | .50 | .88 | .13 |
| PTCCE-6 | 3/8 | .65 | .69 | .48 | .73 | .22 |
| PTCCE-6-8 | 3/8 | .775 | .71 | .50 | .88 | .22 |
| PTCCE-8 | 1/2 | .775 | .91 | .69 | .88 | .34 |

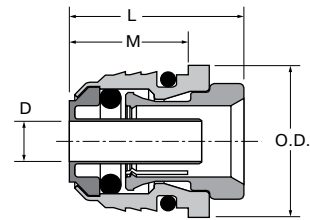

| NOMINAL TUBE OD (IN) | D1 (MM) ±.05 | D1 (IN) ±.002 | L1 (MM) MIN | L1 (IN) MIN | R1 (MM) ±.05 | R1 (IN) ±.002 | R2 (MM) ±.05 | R2 (IN) ±.002 | C1 (MM) ±.05 | C1 (IN) ±.002 |
|----------------------|--------------|---------------|-------------|-------------|--------------|---------------|--------------|---------------|--------------|---------------|
| 1/4 | 12.8 | .504 | 12.7 | .5 | .5 | .02 | .5 | .02 | .5 | .02 |
| 3/8 | 16.5 | .65 | 16.5 | .65 | .5 | .02 | .5 | .02 | .5 | .02 |
| 1/2 | 19.7 | .775 | 19.8 | .78 | .5 | .02 | .5 | .02 | .5 | .02 |
| 5/8 | 23.5 | .925 | 22.4 | .88 | .8 | .03 | .5 | .02 | .8 | .03 |

Cavity material is to be 6061 T6 aluminum

Cavity Specifications

Dimensions are per the SAE Standard J2494-4. The SAE Encapsulated Cartridge is thoroughly tested to meet or exceed the performance requirements of D.O.T. FMVSS 571.106 and SAE J1131 when used in a 6061-T6 aluminum cavity per SAE J2494-4. Cavity dimensions specified by SAE J2494-4 need to be adjusted slightly for optimum performance in material other than 6061-T6.

Installation

Apply force evenly over the top surface of the cartridge body until the cartridge shoulder bottoms out on the top of the cavity. The amount of force required will vary depending on the cartridge size and the material of the cavity.

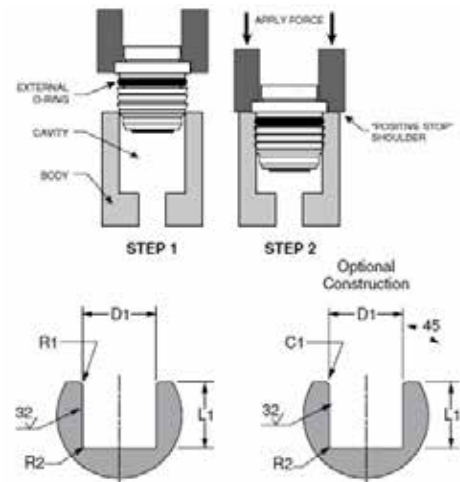

WARNING These products can expose you to chemicals including NICKEL or LEAD, which are known to the state of California to cause cancer, and LEAD which is known to cause birth defects or other reproductive harm. For more information go to www.P65Warnings.ca.gov.



Transportation Push-to-Connect

PTC & PTCR Composite Fittings

PTC Brass Fittings

Metric Prestomatic Fittings

Parker Safe Lock



For more product information visit:
www.parker.com/dot



Threaded Fittings

VS368PTCR
Male Y Connector
NPT
p. E7



VS369PTCR
Male Elbow
NPT
p. E8



369PTCR
Male Elbow Swivel
90° Metric Straight
Thread
p. E8



370PTCR
Female Elbow
NPT
p. E8



VS371PTCR
Run Tee
NPT
p. E9



VS372PTCR
Branch Tee
NPT
p. E9



377PTCR
Female Branch Tee
NPT
p. E9



VS379PTCR
45° Male Elbow
NPT
p. E10



379PTCR
Male Elbow Swivel
45° Metric Straight
Thread
p. E10



66PTC
Female Connector
NPT
p. E13



68PTC / VS68PTC
Male Connector
NPT
p. E14



68PTC
Male Connector
Metric Straight
Thread
p. E14



169PTC
Male Elbow
NPT
p. E14



169PTCNSL
Male Elbow Long
Rigid 90° - NPT
p. E15



169PTCNS
Male Elbow Rigid
NPT
p. E15



169PTCNSL
Male Elbow to Metric
Adjustable
p. E15



170PTC
Female Elbow
Swivel - NPT
p. E15



170PTCNS
Female Elbow
Rigid - NPT
p. E15



171PTC
Run Tee Swivel
NPT
p. E16



171PTCNS
Run Tee Rigid
NPT
p. E16



172PTC
Branch Tee Swivel
NPT
p. E16



172PTCNS
Branch Tee Rigid
NPT
p. E16



179PTC
45° Male Elbow
Swivel - NPT
p. E17



179PTCNS
45° Male Elbow
Rigid - NPT
p. E17



189PTC
Dual Port Elbow
Positional - NPT
p. E17



F8UPMTB
Male Connector
p. E21



C8UPMTB
Male Elbow
p. E21



S8UPMTB
Branch Tee
p. E21



F2PMTB
Male Connector
NPT
p. E21



Tube to Tube Fittings

32PTC
Union
p. E7



362PTC
Union Y
p. E7



362PTC
Unequal Union Y
p. E7



364PTC
Union Tee
p. E7



365PTC
Union Elbow
p. E7



62PTC
Union
p. E14



164PTC
Union Tee
p. E14



165PTC
Union Elbow
p. E14



HPMTB
Union
p. E21



JPMTB
Union Tee
p. E21



WARNING These products can expose you to chemicals including NICKEL or LEAD, which are known to the state of California to cause cancer, and LEAD which is known to cause birth defects or other reproductive harm. For more information go to www.P65Warnings.ca.gov.

Bulkhead Unions

62PTCBHR

Retaining Ring Bulkhead
p. E13, E18



62PTCBH

Bulkhead Union
p. E13, E18



66PTCBH

Bulkhead Female Connector
p. E13



68PTCBH

Bulkhead Male Connector
p. E13



165PTCBH

Elbow Union Bulkhead
p. E18



169PTCBH

Male Elbow Bulkhead
p. E18



Plug-In Fittings

369PTCSP

Male Elbow
p. E8



37PTCSP

Adapter
p. E8



371PTCSP

Run Tee
p. E9



372PTCSP

Branch Tee
p. E9



Accessories

ERHD

External Retainer
p. E18



ES

External Seal
p. E18



639PLP

Plug
p. E19



AQRT

Quick Release Tool
p. E11, E19



PTCB

Collet Caps
p. E11, E19



Manifolds

24M

Presto Manifold
p. E11



Safe Lock Fittings

A613, A614

Safe Lock Straight
p. E23



A623, A624

Safe Lock Elbow
p. E23



68ALS

Brass Adapter
p. E23



WARNING These products can expose you to chemicals including NICKEL or LEAD, which are known to the state of California to cause cancer, and LEAD which is known to cause birth defects or other reproductive harm. For more information go to www.P65Warnings.ca.gov.



- A
- B
- C
- D
- E
- F
- G
- H
- I
- J
- K
- L
- M
- N
- O



PTC & PTCR Composite Fittings

Parker's PTC & PTCR fittings are composite push-to-connect fittings that meet SAE and D.O.T. specifications. Designed for all D.O.T truck and trailer applications, Parker PTC fittings reduce assembly time versus compression style fittings .

Product Features:

- Brass Collet
- HNBR O-ring
- Stainless Steel Tube Support or Brass
- Meets D.O.T. FMVSS571.106
- Meets SAE J2494-3
- Composite Body – Strong, Lightweight, Compact and Impact Resistant
- Plug-in configurations

Markets:

- Heavy Duty Truck
- Trailer
- Mobile

Applications:

- Air Brakes
- Air Tanks
- Air Ride
- Sliders
- Tire Inflation
- Primary & Secondary Air Lines
- Cab Controls

Specifications:

Pressure Range Up to 250 PSI (17.2 bar)

Temperature Range -40° to +200° F (-40° to +93.3° C)

Compatible Tubing:

- SAE J844 Type A & B nylon tubing



Assembly Instructions

1. Cut tubing squarely – maximum of 15° angle allowable.
2. Check that port or mating part is clean and free of debris.
3. Mark tubing to appropriate tube insertion length. (see Tube Insertion Chart on page N22)
4. Insert tubing until it bottoms
5. Pull on tubing to verify it is fully inserted
6. To disassemble, simply press release button, hold against body and pull tubing out of fitting.

WARNING These products can expose you to chemicals including LEAD which is known to the state of California to cause cancer and birth defects or other reproductive harm. For more information go to www.P65Warnings.ca.gov.

[Click here for CADs, Product Specifications or to Configure Parts Online](#)

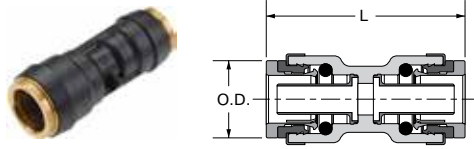

Union 32PTC

| PART NO. | TUBE SIZE | TUBE SIZE 2 | L | O.D. |
|-------------|-----------|-------------|------|------|
| 32PTC-4 | 1/4 | 1/4 | 1.33 | .55 |
| 32PTC-6 | 3/8 | 3/8 | 1.65 | .74 |
| 32PTC-8 | 1/2 | 1/2 | 1.86 | .91 |
| 32PTC-10 | 5/8 | 5/8 | 2.15 | 1.05 |
| 32PTC-12 | 3/4 | 3/4 | 2.50 | 1.21 |
| 32PTC-10-12 | 5/8 | 3/4 | 2.91 | 1.21 |
| 32PTC-4-6M | 1/4 | 6MM | | .55 |
| 32PTC-6-4 | 3/8 | 1/4 | 1.57 | .74 |
| 32PTC-8-6 | 1/2 | 3/8 | 1.95 | .91 |

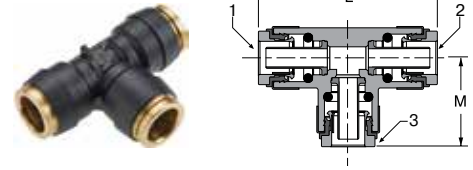

Union Tee 364PTC

| PART NO. | TUBE SIZE 1 | TUBE SIZE 2 | TUBE SIZE 3 | L | M |
|-----------------|-------------|-------------|-------------|------|------|
| 364PTC-4 | 1/4 | 1/4 | 1/4 | 1.52 | .76 |
| 364PTC-6 | 3/8 | 3/8 | 3/8 | 2.03 | 1.01 |
| 364PTC-8 | 1/2 | 1/2 | 1/2 | 2.29 | 1.15 |
| 364PTC-10 | 5/8 | 5/8 | 5/8 | 2.88 | 1.44 |
| 364PTC-6-6-4 | 3/8 | 3/8 | 1/4 | 2.03 | .87 |
| 364PTC-6-6-5/32 | 3/8 | 3/8 | 5/32 | 2.02 | 1.01 |
| 364PTC-4-4-6 | 1/4 | 1/4 | 3/8 | 1.91 | 1.01 |
| 364PTC-4-6-4 | 1/4 | 3/8 | 1/4 | 1.77 | .87 |

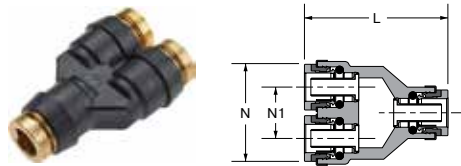

Union Y 362PTC

| PART NO. | TUBE SIZE | L | N | N1 |
|----------|-----------|------|------|-----|
| 362PTC-4 | 1/4 | 1.52 | 1.06 | .50 |
| 362PTC-6 | 3/8 | 2.03 | 1.43 | .68 |
| 362PTC-8 | 1/2 | 2.20 | 1.74 | .84 |



Union Elbow 365PTC

| PART NO. | TUBE SIZE | L |
|----------|-----------|------|
| 365PTC-4 | 1/4 | .76 |
| 365PTC-6 | 3/8 | 1.01 |
| 365PTC-8 | 1/2 | 1.13 |

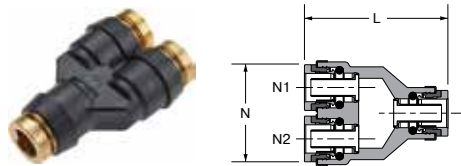

Unequal Union Y 362PTC

| PART NO. | TUBE SIZE | L | N | N1 | N2 |
|--------------|-----------|------|------|-----|-----|
| 362PTC-4-6 | 3/8 | 1.97 | 1.43 | 1/4 | 1/4 |
| 362PTC-4-6-6 | 3/8 | 2.03 | 1.43 | 1/4 | 3/8 |
| 362PTC-4-6-8 | 1/2 | 2.14 | 1.43 | 1/4 | 3/8 |
| 362PTC-6-4 | 1/4 | 2.10 | 1.43 | 3/8 | 3/8 |
| 362PTC-6-8-8 | 1/2 | 2.20 | 1.75 | 1/2 | 3/8 |
| 362PTC-8-4-8 | 1/2 | 2.20 | 1.74 | 1/2 | 1/4 |

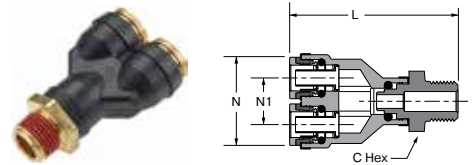

Union Y Male Connector VS368PTCR

| PART NO. | TUBE SIZE | PIPE THREAD | L | C HEX | N | N1 |
|---------------|-----------|-------------|------|-------|------|-----|
| VS368PTCR-4-2 | 1/4 | 1/8 | 1.96 | 9/16 | 1.03 | .50 |
| VS368PTCR-4-4 | 1/4 | 1/4 | 2.12 | 9/16 | 1.03 | .50 |
| VS368PTCR-6-4 | 3/8 | 1/4 | 2.56 | 3/4 | 1.41 | .68 |

WARNING These products can expose you to chemicals including LEAD which is known to the state of California to cause cancer and birth defects or other reproductive harm. For more information go to www.P65Warnings.ca.gov.



- A
- B
- C
- D
- E
- F
- G
- H
- I
- J
- K
- L
- M
- N
- O

[Click here for CADs, Product Specifications or to Configure Parts Online](#)

- A
- B
- C
- D
- E
- F
- G
- H
- I
- J
- K
- L
- M
- N
- O

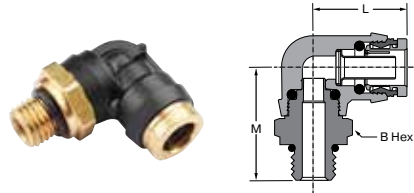

Male Elbow Swivel 90° Metric Straight Thread 369PTCR

| PART NO. | TUBE SIZE | THREAD* | B HEX | L | M |
|-----------------|-----------|---------|--------|------|------|
| 369PTCR-4-MA12 | 1/4 | M12X1.5 | 11/16 | 0.74 | 1.13 |
| 369PTCR-4-MA16 | 1/4 | M16X1.5 | 7/8 | 0.74 | 1.16 |
| 369PTCR-4-MA22 | 1/4 | M22X1.5 | 1 1/16 | 0.74 | 1.28 |
| 369PTCR-6-MA12 | 3/8 | M12X1.5 | 3/4 | 1.01 | 1.22 |
| 369PTCR-6-MA16 | 3/8 | M16X1.5 | 7/8 | 1.01 | 1.29 |
| 369PTCR-6-MA22 | 3/8 | M22X1.5 | 1 1/16 | 1.01 | 1.28 |
| 369PTCR-8-MA12 | 1/2 | M12X1.5 | 15/16 | 1.13 | 1.39 |
| 369PTCR-8-MA16 | 1/2 | M16X1.5 | 15/16 | 1.13 | 1.41 |
| 369PTCR-8-MA22 | 1/2 | M22X1.5 | 1 1/16 | 1.13 | 1.4 |
| 369PTCR-10-MA12 | 5/8 | M12X1.5 | 1 1/16 | 1.36 | 1.63 |
| 369PTCR-10-MA16 | 5/8 | M16X1.5 | 1 1/16 | 1.36 | 1.58 |
| 369PTCR-10-MA22 | 5/8 | M22X1.5 | 1 1/16 | 1.36 | 1.57 |
| 369PTCR-12-MA22 | 3/4 | M22X1.5 | 1 3/16 | 1.47 | 1.84 |

*Per ISO 4039

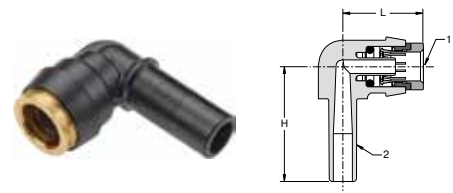

Plug-In Elbow 369PTCSP

| PART NO. | TUBE SIZE 1 | TUBE SIZE 2 | H | L |
|---------------|-------------|-------------|------|------|
| 369PTCSP-4-4 | 1/4 | 1/4 | 1.06 | .74 |
| 369PTCSP-4-6 | 1/4 | 3/8 | 1.20 | .74 |
| 369PTCSP-6-4 | 3/8 | 1/4 | 1.18 | .96 |
| 369PTCSP-6-6 | 3/8 | 3/8 | 1.32 | 0.96 |
| 369PTCSP-6-8 | 3/8 | 1/2 | 1.52 | .96 |
| 369PTCSP-8-4 | 1/2 | 1/4 | 1.16 | 1.12 |
| 369PTCSP-8-6 | 1/2 | 3/8 | 1.30 | 1.12 |
| 369PTCSP-8-8 | 1/2 | 1/2 | 1.50 | 1.12 |
| 369PTCSP-10-8 | 5/8 | 1/2 | 1.57 | 1.36 |
| 369PTC-10-10 | 5/8 | 5/8 | 1.75 | 1.36 |

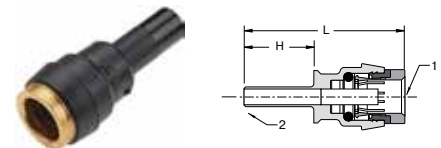

Plug-In Adapter 37PTCSP

| PART NO. | TUBE SIZE 1 | TUBE SIZE 2 | H | L |
|--------------|-------------|-------------|------|------|
| 37PTCSP-4-6 | 1/4 | 3/8 | .90 | 1.71 |
| 37PTCSP-6-4 | 3/8 | 1/4 | .76 | 1.66 |
| 37PTCSP-10-8 | 5/8 | 1/2 | 1.10 | 2.44 |



Male Elbow Swivel 90° VS369PTCR

| PART NO. | TUBE SIZE | PIPE THREAD | B HEX | L | M |
|-----------------|-----------|-------------|--------|------|------|
| VS369PTCR-4-2 | 1/4 | 1/8 | 9/16 | .74 | 1.00 |
| VS369PTCR-4-4 | 1/4 | 1/4 | 9/16 | .74 | 1.14 |
| VS369PTCR-4-6 | 1/4 | 3/8 | 11/16 | .74 | 1.14 |
| VS369PTCR-4-8 | 1/4 | 1/2 | 7/8 | .74 | 1.35 |
| VS369PTCR-6-2 | 3/8 | 1/8 | 3/4 | 1.01 | 1.24 |
| VS369PTCR-6-4 | 3/8 | 1/4 | 3/4 | 1.01 | 1.45 |
| VS369PTCR-6-6 | 3/8 | 3/8 | 3/4 | 1.01 | 1.28 |
| VS369PTCR-6-8 | 3/8 | 1/2 | 7/8 | 1.01 | 1.49 |
| VS369PTCR-8-4 | 1/2 | 1/4 | 15/16 | 1.13 | 1.42 |
| VS369PTCR-8-6 | 1/2 | 3/8 | 15/16 | 1.13 | 1.42 |
| VS369PTCR-8-8 | 1/2 | 1/2 | 15/16 | 1.13 | 1.61 |
| VS369PTCR-10-6 | 5/8 | 3/8 | 1-1/16 | 1.36 | 1.61 |
| VS369PTCR-10-8 | 5/8 | 1/2 | 1-1/16 | 1.36 | 1.80 |
| VS369PTCR-12-8 | 3/4 | 1/2 | 1-3/16 | 1.47 | 1.91 |
| VS369PTCR-12-12 | 3/4 | 3/4 | 1-3/16 | 1.47 | 1.87 |

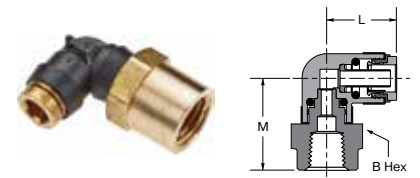

Female Elbow Swivel 90° 370PTCR

| PART NO. | TUBE SIZE | PIPE THREAD | B HEX | L | M |
|-------------|-----------|-------------|-------|------|------|
| 370PTCR-4-2 | 1/4 | 1/8 | 9/16 | .74 | .94 |
| 370PTCR-4-4 | 1/4 | 1/4 | 11/16 | .74 | 1.20 |
| 370PTCR-6-2 | 3/8 | 1/8 | 3/4 | 1.01 | .75 |
| 370PTCR-6-4 | 3/8 | 1/4 | 3/4 | 1.01 | 1.04 |
| 370PTCR-6-6 | 3/8 | 3/8 | 3/4 | 1.01 | 1.19 |
| 370PTCR-8-6 | 1/2 | 3/8 | 3/4 | 1.13 | 1.24 |
| 370PTCR-8-8 | 1/2 | 1/2 | 15/16 | 1.13 | 1.49 |

WARNING These products can expose you to chemicals including LEAD which is known to the state of California to cause cancer and birth defects or other reproductive harm. For more information go to www.P65Warnings.ca.gov.

[Click here for CADs, Product Specifications or to Configure Parts Online](#)

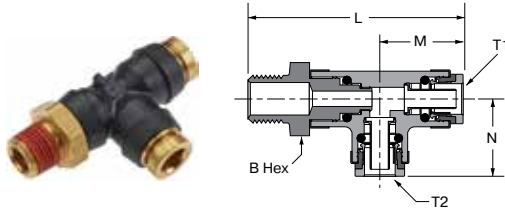

Male Run Tee Swivel VS371PTCR

| PART NO. | TUBE SIZE 1 | TUBE SIZE 2 | PIPE THREAD | B HEX | L | M | N |
|---------------|-------------|-------------|-------------|-------|------|------|------|
| VS371PTCR-4-2 | 1/4 | 1/4 | 1/8 | 9/16 | 1.80 | .76 | .76 |
| VS371PTCR-4-4 | 1/4 | 1/4 | 1/4 | 9/16 | 1.94 | .76 | .76 |
| VS371PTCR-6-4 | 3/8 | 3/8 | 1/4 | 3/4 | 2.25 | 1.01 | 1.01 |
| VS371PTCR-6-6 | 3/8 | 3/8 | 3/8 | 3/4 | 2.25 | 1.01 | 1.01 |
| VS371PTCR-8-4 | 1/2 | 1/2 | 1/4 | 15/16 | 2.59 | 1.15 | 1.15 |
| VS371PTCR-8-6 | 1/2 | 1/2 | 3/8 | 15/16 | 2.59 | 1.15 | 1.15 |
| VS371PTCR-8-8 | 1/2 | 1/2 | 1/2 | 15/16 | 2.78 | 1.15 | 1.15 |
| 371PTCR-4-6 | 1/4 | 1/4 | 3/8 | 11/16 | 1.94 | .76 | .76 |
| 371PTCR-8-4-8 | 1/2 | 1/4 | 1/2 | 15/16 | 2.78 | 1.15 | 1.23 |
| 371PTCR-4-6-4 | 1/4 | 3/8 | 1/4 | 3/4 | 2.25 | 1.01 | .96 |

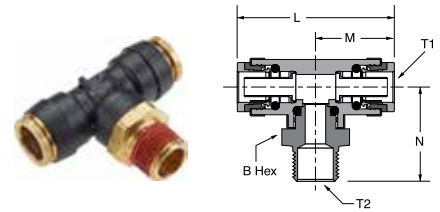

Male Branch Tee Swivel VS372PTCR

| PART NO. | TUBE SIZE | PIPE THREAD | B HEX | L | M | N |
|-----------------|-----------|-------------|--------|------|----------|------|
| VS372PTCR-4-2 | 1/4 | 1/8 | 1/8 | 1.52 | .75 | 1.04 |
| VS372PTCR-4-4 | 1/4 | 1/4 | 9/16 | 1.52 | .76 | 1.18 |
| VS372PTCR-4-6 | 1/4 | 3/8 | 11/16 | 1.52 | .76 | 1.18 |
| VS372PTCR-6-2 | 3/8 | 1/8 | 3/4 | 2.03 | 1.01 | 1.16 |
| VS372PTCR-6-4 | 3/8 | 1/4 | 1/4 | 2.03 | 1.01 | 1.27 |
| VS372PTCR-6-6 | 3/8 | 3/8 | 3/4 | 2.02 | 1.01 | 1.27 |
| VS372PTCR-6-8 | 3/8 | 1/2 | 7/8 | 2.03 | 1.01 | 1.45 |
| VS372PTCR-8-4 | 1/2 | 1/4 | 1/4 | 2.30 | 1.15 | 1.42 |
| VS372PTCR-8-6 | 1/2 | 3/8 | 3/8 | 2.30 | 1.15 | 1.42 |
| VS372PTCR-8-8 | 1/2 | 1/2 | 1/2 | 2.30 | 1.15 | 1.61 |
| VS372PTCR-10-8 | 5/8 | 1/2 | 1 1/16 | 2.88 | 1.44 | 1.80 |
| VS372PTCR-4-6-4 | 1/4-3/8 | 1/4 | 3/4 | 1.91 | .90/1.01 | 1.23 |
| VS372PTCR-6-4-6 | 3/8-1/4 | 3/8 | 3/4 | 1.91 | .90/1.01 | 1.23 |
| VS372PTCR-6-8-8 | 3/8-1/2 | 1/2 | 15/16 | 2.38 | 1.15 | 1.61 |

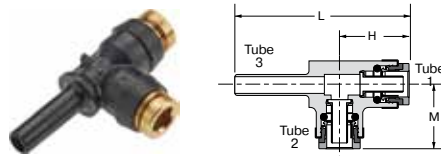

Plug-In Run Tee 371PTCSP

| PART NO. | TUBE SIZE 1 | TUBE SIZE 2 | TUBE SIZE 3 | H | L | M |
|----------------|-------------|-------------|-------------|------|------|------|
| 371PTCSP-4-4 | 1/4 | 1/4 | 1/4 | .78 | 1.84 | .76 |
| 371PTCSP-4-6 | 1/4 | 1/4 | 3/8 | .78 | 1.98 | .76 |
| 371PTCSP-6-4 | 3/8 | 3/8 | 1/4 | 1.01 | 2.11 | 1.01 |
| 371PTCSP-6-6 | 3/8 | 3/8 | 3/8 | 1.01 | 2.25 | 1.01 |
| 371PTCSP-6-4-6 | 3/8 | 1/4 | 3/8 | 0.76 | 2.24 | 1.01 |
| 371PTCSP-8-4-8 | 1/2 | 1/4 | 1/2 | 0.96 | 2.58 | 1.15 |

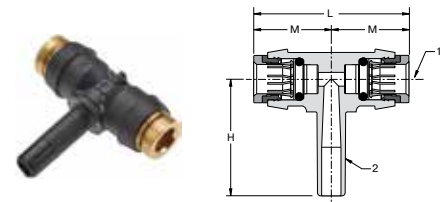

Plug-In Branch Tee 372PTCSP

| PART NO. | TUBE SIZE 1 | TUBE SIZE 2 | H | L | M |
|--------------|-------------|-------------|------|------|------|
| 372PTCSP-4-4 | 1/4 | 1/4 | 1.05 | 1.48 | .74 |
| 372PTCSP-4-6 | 1/4 | 3/8 | 1.19 | 1.48 | .74 |
| 372PTCSP-6-4 | 3/8 | 1/4 | 1.18 | 2.02 | 1.01 |
| 372PTCSP-6-6 | 3/8 | 3/8 | 1.32 | 2.02 | 1.01 |

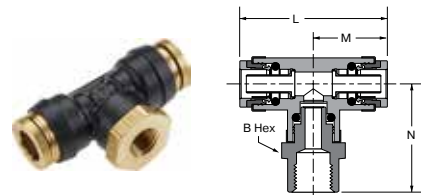

Female Branch Tee Swivel 377PTCR

| PART NO. | TUBE SIZE | PIPE THREAD | B HEX | L | M | N |
|--------------|-----------|-------------|--------|------|------|------|
| 377PTCR-4-4 | 1/4 | 1/4 | 3/4 | 1.48 | .74 | 1.27 |
| 377PTCR-6-2 | 3/8 | 1/8 | 3/4 | 2.03 | 1.01 | .78 |
| 377PTCR-6-4 | 3/8 | 1/4 | 3/4 | 2.03 | 1.01 | 1.07 |
| 377PTCR-10-4 | 5/8 | 1/4 | 1 1/16 | 2.88 | 1.44 | 1.23 |

WARNING These products can expose you to chemicals including LEAD which is known to the state of California to cause cancer and birth defects or other reproductive harm. For more information go to www.P65Warnings.ca.gov.

- A
- B
- C
- D
- E
- F
- G
- H
- I
- J
- K
- L
- M
- N
- O

[Click here for CADs, Product Specifications or to Configure Parts Online](#)

- A
- B
- C
- D
- E
- F
- G
- H
- I
- J
- K
- L
- M
- N
- O

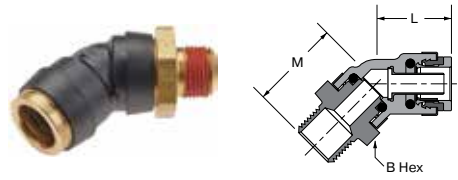

Male Elbow Swivel 45° VS379PTCR

| PART NO. | TUBE SIZE | PIPE THREAD | B HEX | L | M |
|----------------|-----------|-------------|--------|------|------|
| VS379PTCR-4-2 | 1/4 | 1/8 | 9/16 | .68 | .91 |
| VS379PTCR-4-4 | 1/4 | 1/4 | 9/16 | .68 | 1.05 |
| VS379PTCR-6-2 | 3/8 | 1/8 | 3/4 | .89 | .97 |
| VS379PTCR-6-4 | 3/8 | 1/4 | 3/4 | .89 | 1.10 |
| VS379PTCR-6-6 | 3/8 | 3/8 | 3/4 | .89 | 1.11 |
| VS379PTCR-6-8 | 3/8 | 1/2 | 7/8 | .89 | 1.32 |
| VS379PTCR-8-4 | 1/2 | 1/4 | 15/16 | 1.03 | 1.22 |
| VS379PTCR-8-6 | 1/2 | 3/8 | 15/16 | 1.03 | 1.24 |
| VS379PTCR-8-8 | 1/2 | 1/2 | 15/16 | 1.03 | 1.41 |
| VS379PTCR-10-6 | 5/8 | 3/8 | 1-1/16 | 1.21 | 1.43 |
| VS379PTCR-10-8 | 5/8 | 1/2 | 1-1/16 | 1.21 | 1.62 |
| VS379PTCR-12-8 | 3/4 | 1/2 | 1-3/16 | 1.29 | 1.72 |
| VS379PTCR-4-6 | 1/4 | 3/8 | 9/16 | .68 | 1.05 |

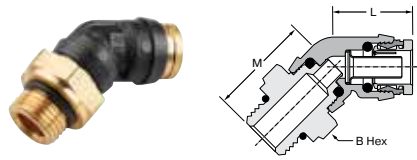

Male Elbow Swivel 45° Metric Straight Thread 379PTCR

| PART NO. | TUBE SIZE | THREAD* | B HEX | L | M |
|-----------------|-----------|-----------|--------|------|------|
| 379PTCR-4-MA12 | 1/4 | M12 X 1.5 | 1 1/16 | 0.68 | 1.05 |
| 379PTCR-4-MA16 | 1/4 | M16 X 1.5 | 7/8 | 0.68 | 1.07 |
| 379PTCR-4-MA22 | 1/4 | M22 X 1.5 | 1 1/16 | 0.68 | 1.19 |
| 379PTCR-6-MA12 | 3/8 | M12 X 1.5 | 3/4 | 0.89 | 1.09 |
| 379PTCR-6-MA16 | 3/8 | M16 X 1.5 | 7/8 | 0.89 | 1.16 |
| 379PTCR-6-MA22 | 3/8 | M22 X 1.5 | 1 1/16 | 0.89 | 1.16 |
| 379PTCR-8-MA12 | 1/2 | M12 X 1.5 | 15/16 | 1.03 | 1.21 |
| 379PTCR-8-MA16 | 1/2 | M16 X 1.5 | 15/16 | 1.03 | 1.21 |
| 379PTCR-8-MA22 | 1/2 | M22 X 1.5 | 1 1/16 | 1.03 | 1.21 |
| 379PTCR-10-MA12 | 5/8 | M12 X 1.5 | 1 1/16 | 1.21 | 1.45 |
| 379PTCR-10-MA16 | 5/8 | M16 X 1.5 | 1 1/16 | 1.21 | 1.4 |
| 379PTCR-10-MA22 | 5/8 | M22 X 1.5 | 1 1/16 | 1.21 | 1.4 |

*Per ISO 4039



Presto Manifold 24M

| PART NO. | TUBE O.D. INLET | TUBE O.D. OUTLET | A | B | D | G | H | M | M1 | N |
|------------|-----------------|------------------|------|------|-----|------|-----|------|------|------|
| 24M-4-4 | 1/4 | 1/4 | 1.33 | 4.15 | .21 | 2.75 | .53 | .90 | .88 | .89 |
| 24M-6-4 | 3/8 | 1/4 | 1.33 | 3.99 | .21 | 2.75 | .53 | .90 | .88 | .89 |
| 24M-6-6 | 3/8 | 3/8 | 1.65 | 6.49 | .22 | 4.55 | .60 | 1.02 | 1.02 | 1.33 |
| 24M-8-8 | 1/2 | 1/2 | 1.65 | 6.49 | .22 | 4.55 | .60 | 1.02 | 1.02 | 1.33 |
| 24M-8-6446 | 1/2 | 3/8 - 1/4 | 1.65 | 6.51 | .22 | 4.55 | .64 | 1.02 | 1.02 | 1.17 |

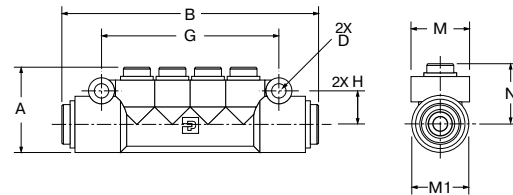

Assembly Instructions

1. Cut tubing squarely with Parker tube cutter PTC-001. Be certain that Manifold ports are clean and free of debris.
2. Insert tubing into port until it bottoms. Pull on tubing to verify that it is properly retained in the manifold.
3. To disassemble, simply hold release button against the manifold body and remove the tubing.
4. To reassemble, make certain that the Manifold ports are clean and free of debris and lubricate leading end of the tubing with light oil or petroleum jelly.

WARNING These products can expose you to chemicals including LEAD which is known to the state of California to cause cancer and birth defects or other reproductive harm. For more information go to www.P65Warnings.ca.gov.

[Click here for CADs, Product Specifications or to Configure Parts Online](#)



AQRT - Quick Release Tool

Makes disconnection of tube adapters and tubing a breeze.



PTCB Collet Caps

| | TUBE O.D. | | | |
|-----------------------------|------------|------------|------------|-------------|
| | 1/4 | 3/8 | 1/2 | 5/8 |
| WHITE PART NO. | 4-PTCB-W | 6-PTCB-W | 8-PTCB-W | 10-PTCB-W |
| BLACK PART NO. | 4-PTCB-BL | 6-PTCB-BL | 8-PTCB-BL | 10-PTCB-BL |
| GREEN PART NO. | 4-PTCB-G | 6-PTCB-G | 8-PTCB-G | 10-PTCB-G |
| RED PART NO. | 4-PTCB-R | 6-PTCB-R | 8-PTCB-R | 10-PTCB-R |
| BLUE PART NO. | 4-PTCB-BU | 6-PTCB-BU | 8-PTCB-BU | 10-PTCB-BU |
| YELLOW PART NO. | 4-PTCB-Y | 6-PTCB-Y | 8-PTCB-Y | 10-PTCB-Y |
| BROWN PART NO. | 4-PTCB-BR | 6-PTCB-BR | 8-PTCB-BR | 10-PTCB-BR |
| GREY PART NO. | 4-PTCB-GR | 6-PTCB-GR | 8-PTCB-GR | 10-PTCB-GR |
| ORANGE PART NO. | 4-PTCB-O | 6-PTCB-O | 8-PTCB-O | 10-PTCB-O |
| PURPLE PART NO. | 4-PTCB-PU | 6-PTCB-PU | 8-PTCB-PU | 10-PTCB-PU |
| DARK PURPLE PART NO. | 4-PTCB-DPU | 6-PTCB-DPU | 8-PTCB-DPU | 10-PTCB-DPU |

- A
- B
- C
- D
- E
- F
- G
- H
- I
- J
- K
- L
- M
- N
- O

WARNING These products can expose you to chemicals including LEAD which is known to the state of California to cause cancer and birth defects or other reproductive harm. For more information go to www.P65Warnings.ca.gov.



A
B
C
D
E
F
G
H
I
J
K
L
M
N
O



PTC Brass Fittings

Parker's PTC Brass Fittings are robust, all brass push-to-connect fittings that meet SAE and D.O.T. specifications. Designed for all D.O.T truck and trailer applications, Parker PTC Brass fittings reduce assembly time versus compression style fittings by 90%.

Product Features:

- Brass Collet
- Buna N O-ring
- Stainless Steel Tube Support
- Meets D.O.T. FMVSS571.106
- Meets SAE J2494 & SAE J2494-3

Markets:

- Heavy Duty Truck
- Trailer
- Mobile

Applications:

- Air Brakes
- Air Tanks
- Air Ride
- Sliders
- Tire Inflation
- Primary & Secondary Air Lines

Specifications:

Pressure Range Up to 250 PSI (17.2 bar)

Temperature Range -40° to +200° F (-40° to +93.3° C)

Compatible Tubing:

- SAE J844 Type A & B nylon tubing

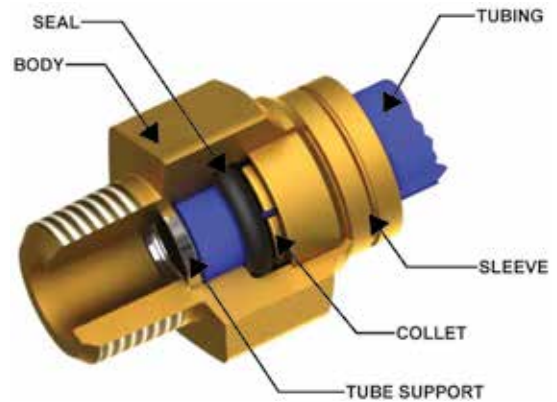

Assembly Instructions

1. Cut tubing squarely – maximum of 15° angle allowable.
2. Check that port or mating part is clean and free of debris.
3. Mark tubing to appropriate tube insertion length. (see Tube Insertion Chart on page N22)
4. Insert tubing until it bottoms
5. Pull on tubing to verify it is fully inserted
6. To disassemble, simply press release button, hold against body and pull tubing out of fitting.



Note:
5/32 and 3/16 units have black button



Note:
Use VS prefix to order with Vibra Seal

WARNING These products can expose you to chemicals including NICKEL or LEAD, which are known to the state of California to cause cancer, and LEAD which is known to cause birth defects or other reproductive harm. For more information go to www.P65Warnings.ca.gov.

[Click here for CADs, Product Specifications or to Configure Parts Online](#)

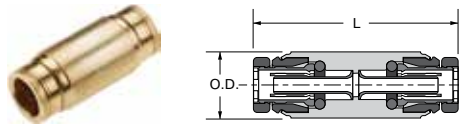

Union 62PTC

| PART NO. | TUBE SIZE | TUBE SIZE 2 | L | O.D. |
|--------------|-----------|-------------|------|------|
| 62PTC-5/32* | 5/32 | 5/32 | 1.35 | .41 |
| 62PTC-3* | 3/16 | 3/16 | 1.36 | .44 |
| 62PTC-4 | 1/4 | 1/4 | 1.37 | 1/2 |
| 62PTC-6 | 3/8 | 3/8 | 1.77 | 3/4 |
| 62PTC-6-4 | 3/8 | 1/4 | 1.57 | 3/4 |
| 62PTC-4-5/32 | 1/4 | 5/32 | | |
| 62PTC-8 | 1/2 | 1/2 | 1.92 | 7/8 |
| 62PTC-10 | 5/8 | 5/8 | 2.32 | 1 |

*5/32 and 3/16 with black button

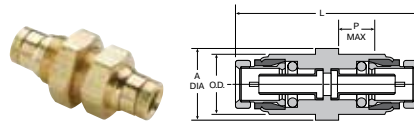

Bulkhead Union 62PTCBH

| PART NO. | TUBE SIZE (IN) | OD (IN) | L (IN) | P MAX (IN) | HEX A (IN) | HEX B (IN) | BULKHEAD HOLE DIA. (IN) |
|------------|----------------|---------|--------|------------|------------|------------|-------------------------|
| 62PTCBH-4 | 1/4 | .56 | 1.69 | .25 | 11/16 | 3/4 | 9/16 |
| 62PTCBH-6 | 3/8 | .88 | 1.93 | .44 | 1 1/16 | 1 1/16 | 7/8 |
| 62PTCBH-8 | 1/2 | 1.00 | 2.02 | .58 | 1 1/4 | 1 1/4 | 1 |
| 62PTCBH-10 | 5/8 | 1.12 | 2.40 | .81 | 1 1/4 | 1 3/8 | 1-1/8 |

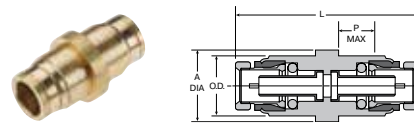

Retaining Ring Bulkhead Union 62PTCBHR

| PART NO. | TUBE SIZE (IN) | OD (IN) | REC. HOLE SIZE (IN) | L (IN) | P. MAX (IN) | A DIA (IN) |
|-------------|----------------|---------|---------------------|--------|-------------|------------|
| 62PTCBHR-4 | 1/4 | .500 | .512 | 1.53 | .26 | .625 |
| 62PTCBHR-6 | 3/8 | .750 | .762 | 1.92 | .36 | .875 |
| 62PTCBHR-8 | 1/2 | .875 | .887 | 2.15 | .43 | 1.000 |
| 62PTCBHR-10 | 5/8 | 1.000 | 1.012 | 2.32 | .48 | 1.250 |

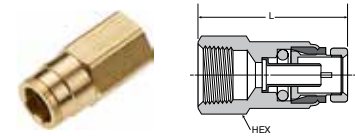

Female Connector 66PTC

| PART NO. | TUBE SIZE | PIPE THREAD | L | HEX |
|---------------|-----------|-------------|-------|-------|
| 66PTC-5/32-2* | 5/32 | 1/8 | 1.16 | 9/16 |
| 66PTC-5/32-4* | 5/32 | 1/4 | 1.33 | 11/16 |
| 66PTC-3-2* | 3/16 | 1/8 | 1.17 | 9/16 |
| 66PTC-4-2 | 1/4 | 1/8 | 9/16 | 1.17 |
| 66PTC-4-4 | 1/4 | 1/4 | 11/16 | 1.37 |
| 66PTC-4-6 | 1/4 | 3/8 | | |
| 66PTC-6-2 | 3/8 | 1/8 | 3/4 | 1.38 |
| 66PTC-6-4 | 3/8 | 1/4 | 3/4 | 1.59 |
| 66PTC-6-6 | 3/8 | 3/8 | 3/4 | 1.59 |
| 66PTC-8-4 | 1/2 | 1/4 | 7/8 | 1.61 |
| 66PTC-8-6 | 1/2 | 3/8 | 15/16 | 1.87 |
| 66PTC-8-8 | 1/2 | 1/2 | 15/16 | 1.87 |
| 66PTC-10-6 | 5/8 | 3/8 | | |
| 66PTC-10-8 | 5/8 | 1/2 | | |

*5/32 and 3/16 with black button

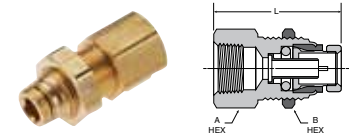

Bulkhead Female Connector 66PTCBH

| PART NO. | TUBE SIZE (IN) | PIPE THREAD (IN) | L (IN) | HEX A (IN) | HEX B (IN) | BULKHEAD HOLE DIA. (IN) |
|-------------|----------------|------------------|--------|------------|------------|-------------------------|
| 66PTCBH-4-4 | 1/4 | 1/4 | 1.62 | 11/16 | 3/4 | 9/16 |
| 66PTCBH-6-6 | 3/8 | 3/8 | 1.87 | 1.06 | 1.06 | 7/8 |
| 66PTCBH-8-8 | 1/2 | 1/2 | 2.02 | 1 1/4 | 1 1/4 | 1 |

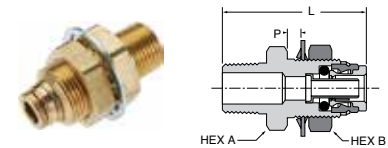

Bulkhead Male Connector 68PTCBH

| PART NO. | TUBE SIZE (IN) | PIPE THREAD (IN) | L (IN) | P MAX (IN) | HEX A (IN) | HEX B (IN) | BULKHEAD HOLE DIA. (IN) |
|-------------|----------------|------------------|--------|------------|------------|------------|-------------------------|
| 68PTCBH-6-8 | 3/8 | 1/2 | 2.37 | .33 | 1 1/4 | 1 1/4 | 1 |
| 68PTCBH-8-8 | 1/2 | 1/2 | 2.38 | .33 | 1 1/4 | 1 1/4 | 1 |

WARNING These products can expose you to chemicals including NICKEL or LEAD, which are known to the state of California to cause cancer, and LEAD which is known to cause birth defects or other reproductive harm. For more information go to www.P65Warnings.ca.gov.

- A
- B
- C
- D
- E
- F
- G
- H
- I
- J
- K
- L
- M
- N
- O

Click here for CADs, Product Specifications or to Configure Parts Online

- A
- B
- C
- D
- E
- F
- G
- H
- I
- J
- K
- L
- M
- N
- O



Male Connector 68PTC

| PART NO. | TUBE SIZE | PIPE THREAD | HEX | L |
|---------------|-----------|-------------|-------|------|
| 68PTC-5/32-1* | 5/32 | 1/16 | 7/16 | .84 |
| 68PTC-5/32-2* | 5/32 | 1/8 | 7/16 | .92 |
| 68PTC-5/32-4* | 5/32 | 1/4 | 9/16 | 1.02 |
| 68PTC-3-1* | 3/16 | 1/16 | 7/16 | .93 |
| 68PTC-3-2* | 3/16 | 1/8 | 7/16 | .85 |
| 68PTC-3-4* | 3/16 | 1/4 | 9/16 | 1.02 |
| 68PTC-4-2 | 1/4 | 1/8 | 1/2 | .98 |
| 68PTC-4-4 | 1/4 | 1/4 | 9/16 | 1.02 |
| 68PTC-4-6 | 1/4 | 3/8 | 11/16 | .93 |
| 68PTC-4-8 | 1/4 | 1/2 | 7/8 | 1.12 |
| 68PTC-6-2 | 3/8 | 1/8 | 11/16 | 1.29 |
| 68PTC-6-4 | 3/8 | 1/4 | 11/16 | 1.44 |
| 68PTC-6-6 | 3/8 | 3/8 | 11/16 | 1.44 |
| 68PTC-6-8 | 3/8 | 1/2 | 7/8 | 1.63 |
| 68PTC-8-4 | 1/2 | 1/4 | 7/8 | 1.51 |
| 68PTC-8-6 | 1/2 | 3/8 | 7/8 | 1.63 |
| 68PTC-8-8 | 1/2 | 1/2 | 7/8 | 1.46 |
| 68PTC-10-6 | 5/8 | 3/8 | 1 | 1.74 |
| 68PTC-10-8 | 5/8 | 1/2 | 1 | 1.81 |
| 68PTC-12-8 | 3/4 | 1/2 | 1 1/8 | 1.89 |
| 68PTC-12-12 | 3/4 | 3/4 | 1/4 | 1.89 |

*5/32 and 3/16 with black button
 **Add VS prefix to order with Vibra Seal

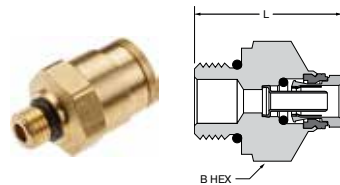

Male Connector Metric Straight Thread 68PTC

| PART NO. | TUBE SIZE | THREAD* | B HEX | L |
|---------------|-----------|---------|--------|------|
| 68PTC-4-MA12 | 1/4 | MA12 | 11/16 | 1.14 |
| 68PTC-4-MA16 | 1/4 | MA16 | 7/8 | 1.21 |
| 68PTC-4-MA22 | 1/4 | MA22 | 1 1/16 | 1.21 |
| 68PTC-6-MA12 | 3/8 | MA12 | 3/4 | 1.31 |
| 68PTC-6-MA16 | 3/8 | MA16 | 7/8 | 1.23 |
| 68PTC-6-MA22 | 3/8 | MA22 | 1 1/16 | 0.74 |
| 68PTC-8-MA12 | 1/2 | MA12 | 7/8 | 1.37 |
| 68PTC-8-MA16 | 1/2 | MA16 | 7/8 | 1.39 |
| 68PTC-8-MA22 | 1/2 | MA22 | 1 1/16 | 0.91 |
| 68PTC-10-MA12 | 5/8 | MA12 | 1 | 1.67 |
| 68PTC-10-MA16 | 5/8 | MA16 | 1 | 1.61 |
| 68PTC-10-MA22 | 5/8 | MA22 | 1 1/16 | 1.37 |

*Per ISO 4039



Union Tee 164PTC

| PART NO. | TUBE 1 SIZE | TUBE 2 SIZE | L1 | L2 |
|--------------|-------------|-------------|------|------|
| 164PTC-5/32* | 5/32 | 5/32 | .77 | .77 |
| 164PTC-3* | 3/16 | 3/16 | .77 | .77 |
| 164PTC-4 | 1/4 | 1/4 | .85 | .85 |
| 164PTC-6 | 3/8 | 3/8 | .81 | .81 |
| 164PTC-6-6-4 | 3/8 | 1/4 | 1.10 | .90 |
| 164PTC-8 | 1/2 | 1/2 | 1.31 | 1.31 |
| 164PTC-10 | 5/8 | 5/8 | 1.57 | 1.57 |

*5/32 and 3/16 with black button



Union Elbow 165PTC

| PART NO. | TUBE SIZE | L |
|--------------|-----------|------|
| 165PTC-5/32* | 5/32 | .79 |
| 165PTC-3* | 3/16 | .77 |
| 165PTC-4 | 1/4 | .80 |
| 165PTC-6 | 3/8 | 1.20 |
| 165PTC-8 | 1/2 | 1.22 |
| 165PTC-10 | 5/8 | 1.49 |

*5/32 and 3/16 with black button

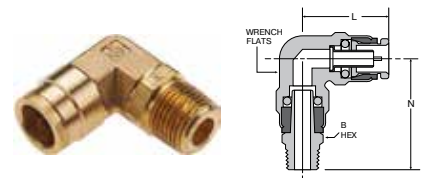

Male Elbow 90° 169PTC

| PART NO. | TUBE SIZE | PIPE THREAD | L | N | WRENCH FLATS | B HEX |
|-------------|-----------|-------------|------|------|--------------|-------|
| 169PTC-4-2 | 1/4 | 1/8 | .85 | .96 | 1/2 | 9/16 |
| 169PTC-4-4 | 1/4 | 1/4 | .85 | 1.22 | 1/2 | 9/16 |
| 169PTC-4-6 | 1/4 | 3/8 | .85 | 1.22 | 1/2 | 11/16 |
| 169PTC-6-2 | 3/8 | 1/8 | 1.02 | 1.21 | 9/16 | 11/16 |
| 169PTC-6-4 | 3/8 | 1/4 | 1.02 | 1.33 | 9/16 | 11/16 |
| 169PTC-6-6 | 3/8 | 3/8 | 1.02 | 1.33 | 9/16 | 11/16 |
| 169PTC-6-8 | 3/8 | 1/2 | 1.02 | 1.33 | 9/16 | 7/8 |
| 169PTC-8-4 | 1/2 | 1/4 | 1.16 | 1.40 | 11/16 | 11/16 |
| 169PTC-8-6 | 1/2 | 3/8 | 1.16 | 1.42 | 11/16 | 11/16 |
| 169PTC-8-8 | 1/2 | 1/2 | 1.16 | 1.63 | 11/16 | 7/8 |
| 169PTC-10-6 | 5/8 | 3/8 | 1.47 | 1.41 | 7/8 | 7/8 |
| 169PTC-10-8 | 5/8 | 1/2 | 1.47 | 1.6 | 7/8 | 7/8 |

*Add VS prefix to order with Vibra Seal

WARNING These products can expose you to chemicals including NICKEL or LEAD, which are known to the state of California to cause cancer, and LEAD which is known to cause birth defects or other reproductive harm. For more information go to www.P65Warnings.ca.gov.



[Click here for CADs, Product Specifications or to Configure Parts Online](#)

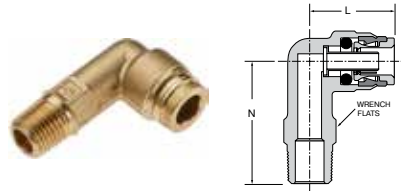

Male Elbow Long Rigid 90° 169PTCNSL

| PART NO. | TUBE SIZE | PIPE THREAD | L | N | WRENCH FLATS |
|---------------|-----------|-------------|------|------|--------------|
| 169PTCNSL-6-4 | 3/8 | 1/4 | 1.01 | 1.63 | 9/16 |
| 169PTCNSL-6-8 | 3/8 | 1/2 | 1.19 | 2.50 | 7/8 |
| 169PTCNSL-6-6 | 3/8 | 3/8 | 1.19 | 2.50 | 7/8 |
| 169PTCNSL-8-8 | 1/2 | 1/2 | 1.22 | 2.50 | 7/8 |

*Add VS prefix to order with Vibra Seal

*5/32 and 3/16 with black button



Male Elbow Rigid 90° 169PTCNS

| PART NO. | TUBE SIZE | PIPE THREAD | L | N | WRENCH FLATS |
|------------------|-----------|-------------|------|------|--------------|
| 169PTCNS-5/32-1* | 5/32 | 1/16 | .79 | .62 | .40 |
| 169PTCNS-5/32-2* | 5/32 | 1/8 | .84 | .65 | .40 |
| 169PTCNS-5/32-4* | 5/32 | 1/4 | .76 | .85 | .50 |
| 169PTCNS-3-2* | 3/16 | 1/8 | .77 | .65 | .40 |
| 169PTCNS-3-4* | 3/16 | 1/4 | .77 | .85 | .50 |
| 169PTCNS-4-2 | 1/4 | 1/8 | .84 | .72 | 1/2 |
| 169PTCNS-4-4 | 1/4 | 1/4 | .85 | .90 | 1/2 |
| 169PTCNS-4-6 | 1/4 | 3/8 | .85 | 1.06 | 1/2 |
| 169PTCNS-6-2 | 3/8 | 1/8 | 1.05 | .75 | 9/16 |
| 169PTCNS-6-4 | 3/8 | 1/4 | 1.05 | .94 | 9/16 |
| 169PTCNS-6-6 | 3/8 | 3/8 | 1.02 | .94 | 9/16 |
| 169PTCNS-6-8 | 3/8 | 1/2 | 1.06 | 1.26 | 11/16 |
| 169PTCNS-8-4 | 1/2 | 1/4 | 1.16 | 1.06 | 11/16 |
| 169PTCNS-8-6 | 1/2 | 3/8 | 1.16 | 1.06 | 11/16 |
| 169PTCNS-8-8 | 1/2 | 1/2 | 1.16 | 1.26 | 11/16 |
| 169PTCNS-10-6 | 5/8 | 3/8 | 1.49 | 1.05 | 7/8 |
| 169PTCNS-10-8 | 5/8 | 1/2 | 1.48 | 1.24 | 7/8 |
| 169PTCNS-12-8 | 3/4 | 1/2 | 1.61 | 1.44 | 1 |
| 169PTCNS-12-12 | 3/4 | 3/4 | 1.61 | 1.50 | 1 |
| 169PTCNS-12-12 | 3/4 | 3/4 | | | |

*5/32 and 3/16 with black button

**Add VS prefix to order with Vibra Seal

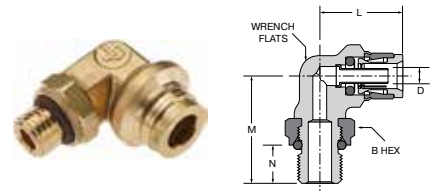

Male Elbow to Metric Adjustable 169PTCNSL

| PART NO. | TUBE SIZE | METRIC THREAD | WRENCH FLATS (MM) | HEX (MM) | L | M | N |
|-----------------|-----------|---------------|-------------------|----------|------|------|-----|
| 169PTCNSL-4-M12 | 1/4 | M12X1.5 | 10 | 17 | .84 | 1.11 | .37 |
| 169PTCNSL-4-M16 | 1/4 | M16X1.5 | 11 | 24 | .88 | 1.27 | .34 |
| 169PTCNSL-4-M22 | 1/4 | M22X1.5 | 19 | 30 | .94 | 1.48 | .37 |
| 169PTCNSL-6-M12 | 3/8 | M12X1.5 | 16 | 17 | 1.00 | 1.15 | .37 |
| 169PTCNSL-6-M16 | 3/8 | M16X1.5 | 19 | 24 | 1.18 | 1.27 | .37 |
| 169PTCNSL-8-M12 | 1/2 | M12X1.5 | 16 | 17 | 1.21 | 1.31 | .37 |
| 169PTCNSL-8-M16 | 1/2 | M16X1.5 | 16 | 24 | 1.20 | 1.28 | .41 |
| 169PTCNSL-8-M22 | 1/2 | M22X1.5 | 19 | 30 | 1.20 | 1.48 | .41 |



Female Elbow Swivel 90° 170PTC

| PART NO. | TUBE SIZE | PIPE THREAD | L | N | HEX | WRENCH FLATS |
|------------|-----------|-------------|-----|------|------|--------------|
| 170PTC-4-2 | 1/4 | 1/8 | .85 | 1.06 | 9/16 | 1/4 |

*Add VS prefix to order with Vibra Seal

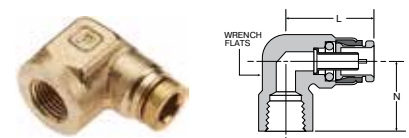

Female Elbow Rigid 90° 170PTCNS

| PART NO. | TUBE SIZE | PIPE THREAD | L | N | WRENCH FLATS |
|-----------------|-----------|-------------|------|-----|--------------|
| 170PTCNS-4-2 | 1/4 | 1/8 | .84 | .56 | 11/16 |
| 170PTCNS-4-4 | 1/4 | 1/4 | .91 | .67 | 11/16 |
| 170PTCNS-6-2 | 3/8 | 1/8 | 1.07 | .51 | 9/16 |
| 170PTCNS-6-4 | 3/8 | 1/4 | 1.07 | .84 | 9/16 |
| 170PTCNS-6-6 | 3/8 | 3/8 | 1.24 | .69 | 7/8 |
| 170PTCNS-8-4 | 1/2 | 1/4 | 1.25 | .75 | 11/16 |
| 170PTCNS-8-6 | 1/2 | 3/8 | 1.36 | .80 | 11/16 |
| 170PTCNS-8-8 | 1/2 | 1/2 | 1.63 | .97 | 1 |
| 170PTCNS-5/32-2 | 5/32 | 1/8 | | | |

WARNING These products can expose you to chemicals including NICKEL or LEAD, which are known to the state of California to cause cancer, and LEAD which is known to cause birth defects or other reproductive harm. For more information go to www.P65Warnings.ca.gov.



Click here for CADs, Product Specifications or to Configure Parts Online

- A
- B
- C
- D
- E
- F
- G
- H
- I
- J
- K
- L
- M
- N
- O

Male Run Tee Swivel 171PTC

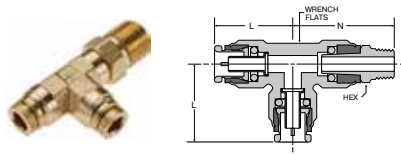

| PART NO. | TUBE SIZE | PIPE THREAD | L | N | HEX | WRENCH FLATS |
|------------|-----------|-------------|------|------|-------|--------------|
| 171PTC-4-2 | 1/4 | 1/8 | .82 | 1.01 | 9/16 | 1/2 |
| 171PTC-4-4 | 1/4 | 1/4 | .82 | 1.23 | 9/16 | 1/2 |
| 171PTC-4-6 | 1/4 | 3/8 | .82 | 1.23 | 11/16 | 1/2 |
| 171PTC-6-4 | 3/8 | 1/4 | 1.10 | 1.35 | 11/16 | 5/8 |
| 171PTC-6-6 | 3/8 | 3/8 | 1.10 | 1.38 | 11/16 | 5/8 |
| 171PTC-8-4 | 1/2 | 1/4 | 1.31 | 1.45 | 11/16 | 3/4 |
| 171PTC-8-6 | 1/2 | 3/8 | 1.31 | 1.48 | 11/16 | 3/4 |
| 171PTC-8-8 | 1/2 | 1/2 | 1.31 | 1.69 | 7/8 | 3/4 |

*Add VS prefix to order with Vibra Seal

Male Branch Tee Swivel 172PTC

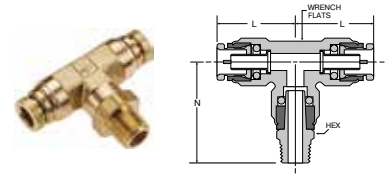

| PART NO. | TUBE SIZE | PIPE THREAD | L | N | HEX | WRENCH FLATS |
|------------|-----------|-------------|------|------|-------|--------------|
| 172PTC-4-2 | 1/4 | 1/8 | .82 | 1.02 | 9/16 | 1/2 |
| 172PTC-4-4 | 1/4 | 1/4 | .82 | 1.23 | 9/16 | 1/2 |
| 172PTC-6-2 | 3/8 | 1/8 | 1.10 | 1.34 | 11/16 | 5/8 |
| 172PTC-6-4 | 3/8 | 1/4 | 1.10 | 1.45 | 11/16 | 5/8 |
| 172PTC-6-6 | 3/8 | 3/8 | 1.10 | 1.48 | 11/16 | 5/8 |
| 172PTC-8-4 | 1/2 | 1/4 | 1.31 | 1.45 | 5/8 | 3/4 |
| 172PTC-8-6 | 1/2 | 3/8 | 1.31 | 1.48 | 11/16 | 3/4 |
| 172PTC-8-8 | 1/2 | 1/2 | 1.31 | 1.97 | 7/8 | 3/4 |

*5/32 and 3/16 with black button

**Add VS prefix to order with Vibra Seal

*5/32 and 3/16 with black button



Male Run Tee Rigid 171PTCNS

| PART NO. | TUBE 1 SIZE | TUBE 2 SIZE | PIPE THREAD | L1 | L2 | N | WRENCH FLATS |
|------------------|-------------|-------------|-------------|------|------|------|--------------|
| 171PTCNS-5/32-2* | 5/32 | 5/32 | 1/8 | .76 | .76 | .75 | 7/16 |
| 171PTCNS-5/32-4* | 5/32 | 5/32 | 1/4 | .76 | .76 | .88 | 7/16 |
| 171PTCNS-3-2* | 3/16 | 3/16 | 1/8 | .77 | .77 | .75 | 7/16 |
| 171PTCNS-4-2 | 1/4 | 1/4 | 1/8 | .91 | .91 | .77 | 15/32 |
| 171PTCNS-4-4 | 1/4 | 1/4 | 1/4 | .88 | .88 | .91 | 15/32 |
| 171PTCNS-4-6-4 | 1/4 | 3/8 | 1/4 | .88 | 1.10 | .97 | 5/8 |
| 171PTCNS-6-4 | 3/8 | 3/8 | 1/4 | 1.10 | 1.10 | .97 | 5/8 |
| 171PTCNS-6-4-4 | 3/8 | 1/4 | 1/4 | 1.10 | .88 | .97 | 5/8 |
| 171PTCNS-6-4-6 | 3/8 | 1/4 | 3/8 | 1.22 | .97 | .93 | 5/8 |
| 171PTCNS-6-6 | 3/8 | 3/8 | 3/8 | 1.10 | 1.10 | .91 | 5/8 |
| 171PTCNS-6-8 | 3/8 | 3/8 | 1/2 | 1.09 | 1.17 | 1.26 | 5/8 |
| 171PTCNS-8-4 | 1/2 | 1/2 | 1/4 | 1.31 | 1.28 | 1.07 | 3/4 |

*5/32 and 3/16 with black button

**Add VS prefix to order with Vibra Seal

*5/32 and 3/16 with black button



Male Branch Tee Rigid 172PTCNS

| PART NO. | TUBE 1 SIZE | TUBE 2 SIZE | PIPE THREAD | L1 | L2 | N | WRENCH FLATS |
|------------------|-------------|-------------|-------------|------|------|------|--------------|
| 172PTCNS-5/32-2* | 5/32 | 1/8 | .78 | .75 | 7/16 | .47 | 15/32 |
| 172PTCNS-5/32-4* | 5/32 | 1/4 | .78 | .88 | 7/16 | .47 | 15/32 |
| 172PTCNS-3-2* | 3/16 | 1/8 | .77 | .75 | 7/16 | .47 | 15/32 |
| 172PTCNS-4-2 | 1/4 | 1/4 | 1/8 | .91 | .91 | .77 | 1/2 |
| 172PTCNS-4-4 | 1/4 | 1/4 | 1/4 | | | | |
| 172PTCNS-6-4 | 3/8 | 3/8 | 1/4 | 1.10 | 1.10 | .97 | 5/8 |
| 172PTCNS-6-4-4 | 3/8 | 1/4 | 1/4 | 1.10 | .85 | .97 | 5/8 |
| 172PTCNS-6-6 | 3/8 | 3/8 | 3/8 | 1.04 | 1.04 | .91 | 5/8 |
| 172PTCNS-6-8 | 3/8 | 3/8 | 1/2 | 1.17 | 1.17 | 1.26 | 7/8 |
| 172PTCNS-8-6 | 1/2 | 1/2 | 3/8 | 1.31 | 1.31 | 1.07 | 3/4 |
| 172PTCNS-8-6-8 | 1/2 | 3/8 | 1/2 | 1.31 | 1.24 | 1.25 | 3/4 |
| 172PTCNS-8-8 | 1/2 | 1/2 | 1/2 | 1.31 | 1.31 | 1.25 | 3/4 |

*Add VS prefix to order with Vibra Seal

WARNING These products can expose you to chemicals including NICKEL or LEAD, which are known to the state of California to cause cancer, and LEAD which is known to cause birth defects or other reproductive harm. For more information go to www.P65Warnings.ca.gov.



Click here for CADs, Product Specifications or to Configure Parts Online

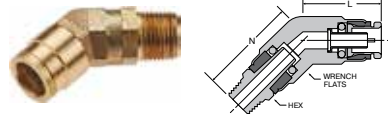

Male Elbow Swivel 45° 179PTC

| PART NO. | TUBE SIZE | PIPE THREAD | L | N | HEX | WRENCH FLATS |
|-------------|-----------|-------------|------|------|-------|--------------|
| 179PTC-4-2 | 1/4 | 1/8 | .76 | .93 | 9/16 | 9/16 |
| 179PTC-4-4 | 1/4 | 1/4 | .76 | 1.15 | 9/16 | 9/16 |
| 179PTC-6-2 | 3/8 | 1/8 | .95 | 1.05 | 11/16 | 3/4 |
| 179PTC-6-4 | 3/8 | 1/4 | .95 | 1.17 | 11/16 | 3/4 |
| 179PTC-6-6 | 3/8 | 3/8 | .95 | 1.20 | 11/16 | 3/4 |
| 179PTC-8-4 | 1/2 | 1/4 | 1.15 | 1.70 | 13/16 | 13/16 |
| 179PTC-8-6 | 1/2 | 3/8 | 1.15 | 1.78 | 13/16 | 13/16 |
| 179PTC-8-8 | 1/2 | 1/2 | 1.15 | 1.93 | 7/8 | 13/16 |
| 179PTC-10-8 | 5/8 | 1/2 | | | | |

*Add VS prefix to order with Vibra Seal

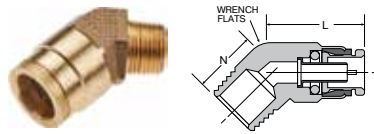

Male Elbow Rigid 45° 179PTCNS

| PART NO. | TUBE SIZE | PIPE THREAD | L | N | WRENCH FLATS |
|---------------|-----------|-------------|------|------|--------------|
| 179PTCNS-4-2 | 1/4 | 1/8 | .74 | .56 | 9/16 |
| 179PTCNS-4-4 | 1/4 | 1/4 | .74 | .69 | 9/16 |
| 179PTCNS-6-2 | 3/8 | 1/8 | 1.06 | .60 | 9/16 |
| 179PTCNS-6-4 | 3/8 | 1/4 | 1.06 | .69 | 9/16 |
| 179PTCNS-6-6 | 3/8 | 3/8 | 1.06 | .85 | 9/16 |
| 179PTCNS-6-8 | 3/8 | 1/2 | | | |
| 179PTCNS-8-4 | 1/2 | 1/4 | 1.15 | .75 | 13/16 |
| 179PTCNS-8-6 | 1/2 | 3/8 | 1.15 | .75 | 13/16 |
| 179PTCNS-8-8 | 1/2 | 1/2 | 1.15 | 1.00 | 13/16 |
| 179PTCNS-10-6 | 5/8 | 3/8 | 1.20 | .76 | 7/8 |
| 179PTCNS-10-8 | 5/8 | 1/2 | 1.21 | .95 | 7/8 |
| 179PTCNS-12-8 | 3/4 | 1/2 | 1.33 | 1.19 | 1 |

*Add VS prefix to order with Vibra Seal

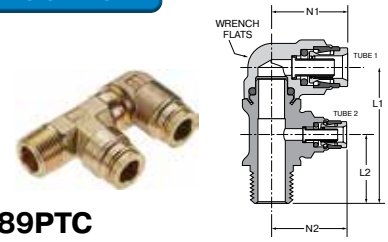

Dual Port 90 Male Elbow Positional 189PTC

| PART NO. | TUBE 1 SIZE | TUBE 2 SIZE | PIPE THREAD | L1 | L2 | N1 | N2 | WRENCH FLATS |
|----------------|-------------|-------------|-------------|------|------|------|------|--------------|
| 189PTC-6-4-6 | 3/8 | 1/4 | 3/8 | 2.12 | 1.05 | 1.21 | 1.19 | 11/16 |
| 189PTC-6-6-4 | 3/8 | 3/8 | 1/4 | 2.06 | .98 | 1.12 | 1.20 | 9/16 |
| 189PTC-6-6-6 | 3/8 | 3/8 | 3/8 | 2.06 | .98 | 1.12 | 1.20 | 9/16 |
| 189PTC-10-4-6 | 5/8 | 1/4 | 3/8 | 2.27 | .99 | 1.47 | 1.13 | 7/8 |
| 189PTC-10-6-6 | 5/8 | 3/8 | 3/8 | 2.35 | 1.06 | 1.47 | 1.13 | 7/8 |
| 189PTC-8-4-8 | 1/2 | 1/4 | 1/2 | | | | | |
| 189PTC-8-6-6 | 1/2 | 3/8 | 3/8 | | | | | |
| 189PTC-8-6-8 | 1/2 | 3/8 | 1/2 | | | | | |
| 189PTC-10-4-8 | 5/8 | 1/4 | 1/2 | | | | | |
| 189PTC-10-6-8 | 5/8 | 3/8 | 1/2 | | | | | |
| 189PTC-10-10-8 | 5/8 | 5/8 | 1/2 | | | | | |

*Add VS prefix to order with Vibra Seal

WARNING These products can expose you to chemicals including NICKEL or LEAD, which are known to the state of California to cause cancer, and LEAD which is known to cause birth defects or other reproductive harm. For more information go to www.P65Warnings.ca.gov.



Click here for CADs, Product Specifications or to Configure Parts Online

- A
- B
- C
- D
- E
- F
- G
- H
- I
- J
- K
- L
- M
- N
- O

Retaining Ring Bulkhead Unions

Retaining ring bulkhead unions feature a unique design that provides the user with an economical method to install and assemble a union connection through a bulkhead.

The retaining ring bulkhead unions feature a smaller envelope size than standard bulkhead union connectors and do not require a wrench to mount or assemble in cramped areas.

The external seal feature provides a moisture barrier and can also prevent external contamination from entering into an enclosed area.

To install, simply support the bulkhead union from behind and apply the external seal. Then push the external retainer against the external seal with an assembly tool and you have a reliable bulkhead connection in a confined area.

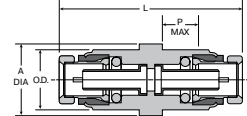
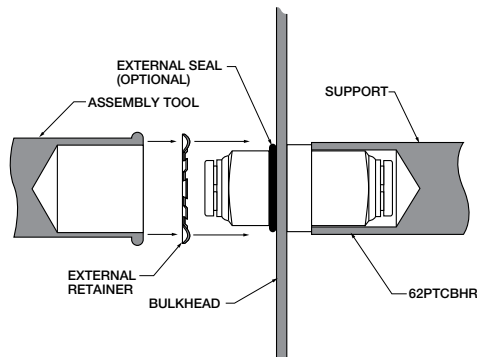

Retaining Ring Bulkhead 62PTCBHR

| PART NO. | TUBE SIZE | O. D. | REC. HOLE SIZE | L | P MAX | A DIA. |
|-------------|-----------|-------|----------------|------|-------|--------|
| 62PTCBHR-4* | 1/4 | .500 | .512 | 1.53 | .26 | .625 |
| 62PTCBHR-6 | 3/8 | .750 | .762 | 1.92 | .36 | .875 |
| 62PTCBHR-8 | 1/2 | .875 | .887 | 2.15 | .43 | 1.000 |
| 62PTCBHR-10 | 5/8 | 1.000 | 1.012 | 2.32 | .48 | 1.250 |

*Sleeve color may vary

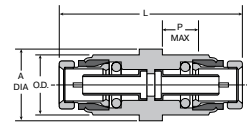

Bulkhead Union 62PTCBH

| PART NO. | TUBE SIZE | O. D. | L | P MAX | HEX A | HEX B | A DIA. |
|------------|-----------|-------|------|-------|--------|--------|--------|
| 62PTCBH-4* | 1/4 | .56 | 1.69 | .25 | 11/16 | 3/4 | 9/16 |
| 62PTCBH-6 | 3/8 | .88 | 1.93 | .44 | 1-1/16 | 1-1/16 | 7/8 |
| 62PTCBH-8 | 1/2 | 1.00 | 2.02 | .58 | 1-1/4 | 1-1/4 | 1 |
| 62PTCBH-10 | 5/8 | 1.12 | 2.40 | .81 | 1-1/4 | 1-3/8 | 1-1/8 |

*Sleeve color may vary

External Retainer ERHD*

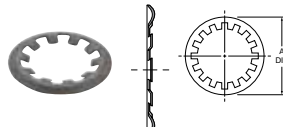

| PART NO. | TUBE SIZE | BULKHEAD UNION O. D. | A DIA. | W |
|----------|-----------|----------------------|--------|-----|
| ERHD-50 | 1/4 | .500 | .83 | .05 |
| ERHD-75 | 3/8 | .750 | 1.08 | .05 |
| ERHD-87 | 1/2 | .875 | 1.20 | .05 |
| ERHD-100 | 5/8 | 1.000 | 1.33 | .06 |

*Material Carbon Spring Steel

External Seal ES*

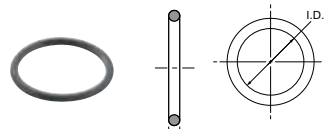

| PART NO. | TUBE SIZE | BULKHEAD UNION O. D. | I. D. | W |
|--------------|-----------|----------------------|-------|-----|
| 2564-40001-L | 1/4 | .500 | .489 | .07 |
| 2564-60001 | 3/8 | .750 | .739 | .07 |
| 2564-00253 | 1/2 | .875 | .864 | .07 |

*Material is Nitrile (Buna N), 70 Durometer

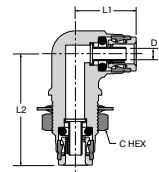

Union Bulkhead Elbow 165PTCBH

| PART NO. | TUBE SIZE | L1 | L2 | C HEX | FLOW DIA. D | BULKHEAD HOLE DIA. |
|------------|-----------|------|------|-------|-------------|--------------------|
| 165PTCBH-8 | 1/2 | 1.20 | 2.51 | 1 1/4 | .34 | 1 |

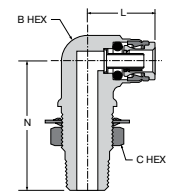

Male Elbow Bulkhead 169PTCNSBH

| PART NO. | TUBE SIZE | PIPE THREAD | L | N | B HEX | C HEX | BULKHEAD HOLE DIA. |
|----------------|-----------|-------------|------|------|-------|-------|--------------------|
| 169PTCNSBH-6-8 | 1/2 | 1/2 | 1.29 | 2.50 | 1-1/4 | 7/8 | 1 |

WARNING These products can expose you to chemicals including NICKEL or LEAD, which are known to the state of California to cause cancer, and LEAD which is known to cause birth defects or other reproductive harm. For more information go to www.P65Warnings.ca.gov.



Click here for CADs, Product Specifications or to Configure Parts Online

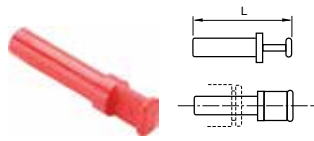

639PLP Plug

| PART NO. | TUBE SIZE (IN) | L |
|----------|----------------|------|
| 639PLP-4 | 1/4 | 1.44 |
| 639PLP-6 | 3/8 | 1.67 |
| 639PLP-8 | 1/2 | 1.91 |



AQRT - Quick Release Tool

Makes disconnection of tube adapters and tubing a breeze.



PTCB Collet Caps

| | TUBE O.D. | | | |
|-----------------------------|------------|------------|------------|-------------|
| | 1/4 | 3/8 | 1/2 | 5/8 |
| WHITE PART NO. | 4-PTCB-W | 6-PTCB-W | 8-PTCB-W | 10-PTCB-W |
| BLACK PART NO. | 4-PTCB-BL | 6-PTCB-BL | 8-PTCB-BL | 10-PTCB-BL |
| GREEN PART NO. | 4-PTCB-G | 6-PTCB-G | 8-PTCB-G | 10-PTCB-G |
| RED PART NO. | 4-PTCB-R | 6-PTCB-R | 8-PTCB-R | 10-PTCB-R |
| BLUE PART NO. | 4-PTCB-BU | 6-PTCB-BU | 8-PTCB-BU | 10-PTCB-BU |
| YELLOW PART NO. | 4-PTCB-Y | 6-PTCB-Y | 8-PTCB-Y | 10-PTCB-Y |
| BROWN PART NO. | 4-PTCB-BR | 6-PTCB-BR | 8-PTCB-BR | 10-PTCB-BR |
| GREY PART NO. | 4-PTCB-GR | 6-PTCB-GR | 8-PTCB-GR | 10-PTCB-GR |
| ORANGE PART NO. | 4-PTCB-O | 6-PTCB-O | 8-PTCB-O | 10-PTCB-O |
| PURPLE PART NO. | 4-PTCB-PU | 6-PTCB-PU | 8-PTCB-PU | 10-PTCB-PU |
| DARK PURPLE PART NO. | 4-PTCB-DPU | 6-PTCB-DPU | 8-PTCB-DPU | 10-PTCB-DPU |

WARNING These products can expose you to chemicals including NICKEL or LEAD, which are known to the state of California to cause cancer, and LEAD which is known to cause birth defects or other reproductive harm. For more information go to www.P65Warnings.ca.gov.





Metric Prestomatic Fittings

Parker's Metric Prestomatic Fittings are robust, all brass push-to-connect fittings that meet DIN and D.O.T. specifications. Designed for all D.O.T truck and trailer applications, Parker Metric Prestomatic fittings reduce assembly time versus compression style fittings by 90%.

Product Features:

- Brass Collet
- Buna N O-ring
- Stainless Steel Tube Support
- Meets D.O.T. FMVSS571.106
- Meets DIN 74324

Markets:

- Heavy Duty Truck
- Trailer
- Mobile

Applications:

- Air Brakes
- Air Tanks
- Air Ride
- Sliders
- Tire Inflation
- Primary & Secondary Air Lines

Specifications:

Pressure Range Up to 250 PSI (17.2 bar)

Temperature Range -40° to +200° F (-40° to +93.3° C)

Compatible Tubing:

- DIN 73378 Virgin Nylon
- SAE J844 Type A & B nylon tubing

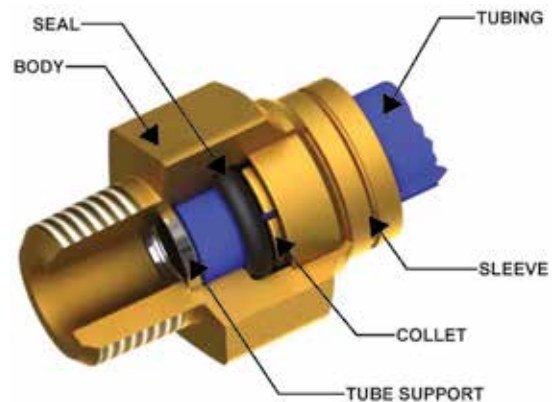

Assembly Instructions

1. Cut tubing squarely – maximum of 15° angle allowable.
2. Check that port or mating part is clean and free of debris.
3. Mark tubing to appropriate tube insertion length. (see Tube Insertion Chart on page N22)
4. Insert tubing until it bottoms
5. Pull on tubing to verify it is fully inserted
6. To disassemble, simply press release button, hold against body and pull tubing out of fitting.

WARNING These products can expose you to chemicals including NICKEL or LEAD, which are known to the state of California to cause cancer, and LEAD which is known to cause birth defects or other reproductive harm. For more information go to www.P65Warnings.ca.gov.



[Click here for CADs, Product Specifications or to Configure Parts Online](#)

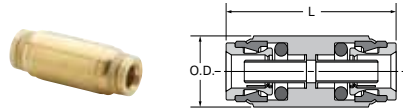

Union HPMTB

| PART NO. | TUBE SIZE (MM) | L (MM) | O.D. (MM) |
|----------|----------------|--------|-----------|
| HPMTB6 | 6 | 45.2 | 15.9 |
| HPMTB8 | 8 | 45.3 | 17.5 |
| HPMTB10 | 10 | 51.7 | 22.2 |
| HPMTB12 | 12 | 51.7 | 22.2 |

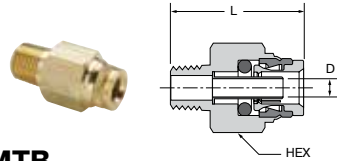

Male Connector F2PMTB

| PART NO. | TUBE (MM) | PIPE THREAD | L (MM) | HEX (MM) | FLOW DIA. D(MM) |
|--------------|-----------|-------------|--------|----------|-----------------|
| F2PMTB8-1/8 | 8 | 1/8 | 33.79 | 19 | 4.90 |
| F2PMTB10-1/4 | 10 | 1/4 | 36.83 | 20 | 6.35 |

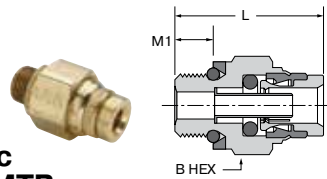

Male Connector Metric Straight Thread F8UPMTB

| PART NO. | TUBE SIZE (mm) | METRIC THREAD | L (mm) | B HEX (MM) | M1 (MM) |
|---------------|----------------|---------------|--------|------------|---------|
| F8UPMTB6-M10 | 6 | M10X1 | 29.7 | 17 | 6.4 |
| F8UPMTB6-M12 | 6 | M12X1.5 | 29.1 | 17 | 7.5 |
| F8UPMTB6-M22 | 6 | M22X1.5 | 29.7 | 27 | 9.5 |
| F8UPMTB8-M16 | 8 | M16X1.5 | 31.0 | 22 | 10.0 |
| F8UPMTB10-M16 | 10 | M16X1.5 | 37.5 | 22 | 10.0 |
| F8UPMTB10-M22 | 10 | M22X1.5 | 31.1 | 27 | 9.5 |
| F8UPMTB12-M12 | 12 | M12X1.5 | 37.3 | 22 | 7.5 |
| F8UPMTB12-M22 | 12 | M22X1.5 | 33.4 | 27 | 9.5 |
| F8UPMTB16-M22 | 16 | M22X1.5 | 33.3 | 27 | 9.5 |

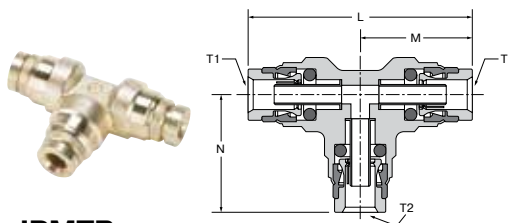

Union Tee JPMTB

| PART NO. | TUBE 1 (MM) | TUBE 2 (MM) | L (MM) | M (MM) | N (MM) |
|--------------|-------------|-------------|--------|--------|--------|
| JPMTB6 | 6 | 6 | 51.3 | 25.6 | 26.7 |
| JPMTB12 | 12 | 12 | 63.3 | 31.7 | 35.0 |
| JPMTB12-12-6 | 12 | 6 | 63.3 | 31.7 | 28.1 |

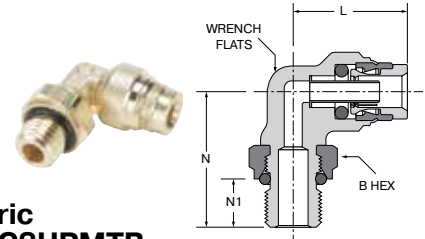

Male Elbow Metric Straight Thread C8UPMTB

| PART NO. | TUBE SIZE (MM) | B METRIC THREAD | WRENCH FLATS (MM) | HEX (MM) | L (MM) | N (MM) | N1 (MM) |
|--------------|----------------|-----------------|-------------------|----------|--------|--------|---------|
| C8UPMTB6-M12 | 6 | M12X1.5 | 10 | 17 | 24.8 | 28.2 | 9.5 |
| C8UPMTB6-M16 | 6 | M16X1.5 | 11 | 24 | 25.0 | 34.0 | 10.5 |

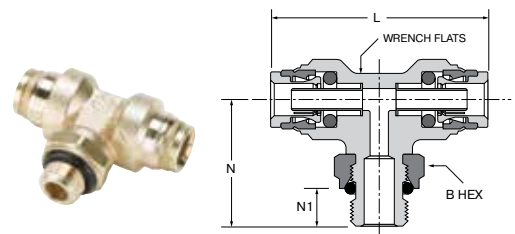

Male Branch Tee Swivel Metric Straight Thread S8UPMTB

| PART NO. | TUBE SIZE (MM) | METRIC THREAD | WRENCH FLATS (MM) | HEX (MM) | L (MM) | N (MM) | N1 (MM) |
|---------------|----------------|---------------|-------------------|----------|--------|--------|---------|
| S8UPMTB12-M16 | 12 | M16X1.5 | 19 | 24 | 65.9 | 37.6 | 10.5 |

WARNING These products can expose you to chemicals including NICKEL or LEAD, which are known to the state of California to cause cancer, and LEAD which is known to cause birth defects or other reproductive harm. For more information go to www.P65Warnings.ca.gov.



- A
- B
- C
- D
- E
- F
- G
- H
- I
- J
- K
- L
- M
- N
- O

A
B
C
D
E
F
G
H
I
J
K
L
M
N
O



Parker Safe Lock

Parker Safe Lock push-to-connect fittings reduce assembly time and the exclusive locking mechanism minimizes leaks and installation failures.

Parker Safe Lock Product Features:

- Composite Body – Strong, Lightweight, Compact and Impact Resistant
- Fluorocarbon and Fluorosilicone O-ring
- Meets SAE J2044

Markets:

- Heavy Duty Truck
- Trailer
- Mobile

Applications:

- Engine Fuel, Coolant and Vapor Lines

Specifications:

Pressure Range -7.2 to +72 PSI (-0.4 to 4.9 bar)

Temperature Range -40° to +239° F (-40° to +115° C)

Parker Brass Adapter Product Features:

- **Construction:** Corrosion resistant high temperature brass
- **Configuration:** Rigid male pipe
- **Industry Standard:** SAE J2044

WARNING These products can expose you to chemicals including NICKEL or LEAD, which are known to the state of California to cause cancer, and LEAD which is known to cause birth defects or other reproductive harm. For more information go to www.P65Warnings.ca.gov.

[Click here for CADs, Product Specifications or to Configure Parts Online](#)

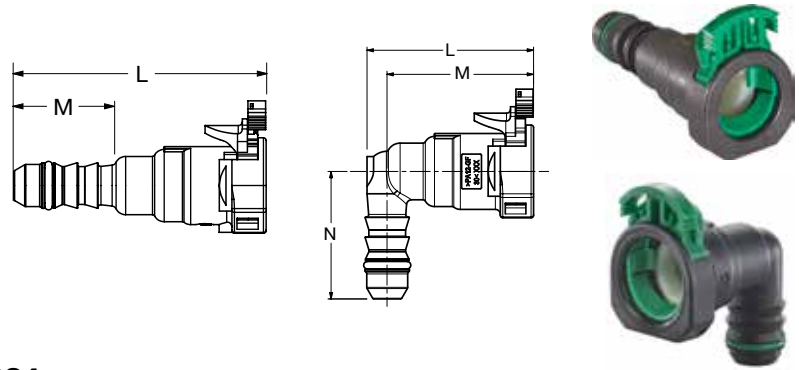

Parker Safe Lock A613, A614, A623, A624

| END FORM | BARB TAIL | CONFIGURATION | PART NUMBER** AVAILABLE FROM FSC* | L (MM) | M (MM) | N (MM) |
|----------|-----------|---------------|--------------------------------------|-----------|-----------|-----------|
| 5/16" | 5/16" | STRAIGHT | A614A50G06 02 | 49.40 | 19.50 | N/A |
| | | 90 DEGREE | A624A50D06 02 | 29.50 | 19.50 | 25.70 |
| 10MM | 3/8" | STRAIGHT | A613 52 08 00 | 55.00 | 19.00 | N/A |
| | | 90 DEGREE | A623A52 08 00 | 34.40 | 19.00 | 32.00 |
| 3/8" | 3/8" | STRAIGHT | A614M53 08 02 | 55.00 | 21.50 | N/A |
| | | 90 DEGREE | A624M53 08 02 | 34.05 | 21.50 | 28.60 |
| 12MM | 1/2" | STRAIGHT | A614A58 55 04 | 59.35 | 21.00 | N/A |
| | | 90 DEGREE | A624A58 55 04 | 39.00 | 21.00 | 29.70 |
| 1/2" | 1/2" | STRAIGHT | A614C56 55 05 | 59.15 | 21.00 | N/A |
| | | 90 DEGREE | A624C56 55 05 | 39.00 | 21.00 | 29.70 |
| 5/8" | 5/8" | STRAIGHT | A614D57 56 02 A | 58.20 | 20.00 | N/A |
| | | 90 DEGREE | 624F57 56 02 | 39.10 | 20.00 | 30.10 |

*FSC is the Parker Fluid System Connectors Division. See back cover for contact information.

**Safe Lock Connector part numbers contain spaces.



Parker Safe Lock Brass Adapter 68ALS

| PART NUMBER AVAILABLE FROM FSC* | END FORM | THREAD SIZE | PART NUMBER AVAILABLE FROM FSC* | END FORM | THREAD SIZE |
|------------------------------------|----------|-------------|------------------------------------|----------|-------------|
| 68ALS-5-4 | 5/16" | 1/4" | 68ALS-12M-8 | 12MM | 1/2" |
| 68ALS-6-4 | 3/8" | 1/4" | 68ALS-8-6 | 1/2" | 3/8" |
| 68ALS-6-6 | 3/8" | 3/8" | 68ALS-8-8 | 1/2" | 1/2" |
| 68ALS-12M-6 | 12MM | 3/8" | 68ALS-10-8 | 5/8" | 1/2" |

Adapters are available with Metric Straight Thread O-Rings and Electroless Nickel Plating Upon Request

WARNING These products can expose you to chemicals including NICKEL or LEAD, which are known to the state of California to cause cancer, and LEAD which is known to cause birth defects or other reproductive harm. For more information go to www.P65Warnings.ca.gov.



- A
- B
- C
- D
- E
- F
- G
- H
- I
- J
- K
- L
- M
- N
- O



Transportation Compression Fittings & Valves

Air Brake-NTA® Fittings

Transmission Fittings

Air Brake - AB Fittings

Air Brake Hose Ends Fittings

Vibra-Lok Fittings

Truck Valves & Lanyard Valve



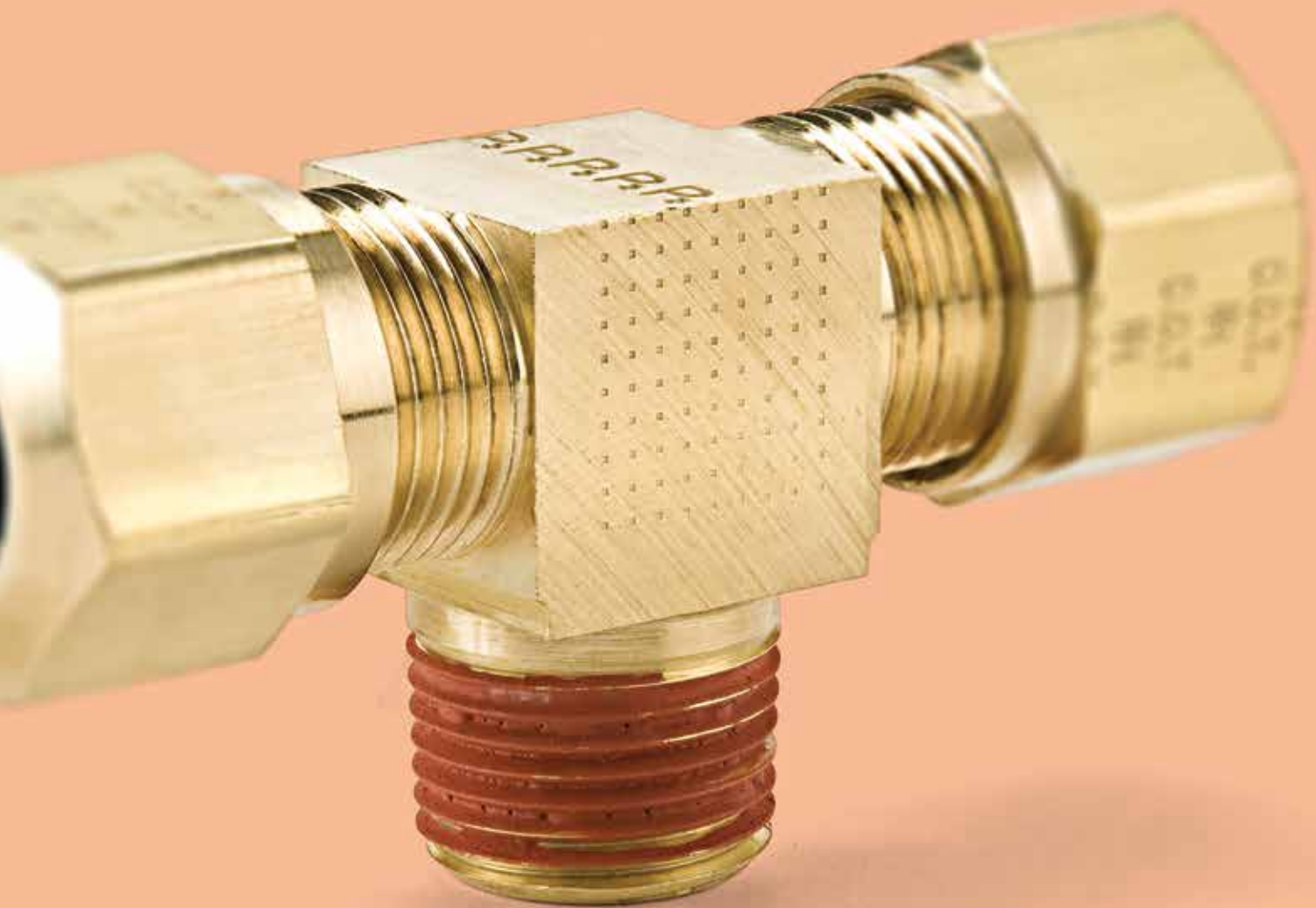

■ Air Brake-NTA® Fittings

60NTA
Sleeve
p. F7



61NTA
Nut
p. F7



62NTA
Union
p. F7



62ANBH
Bulkhead Union
p. F7



62NBH
Bulkhead Union
p. F7



62NFBH
Bulkhead Union
p. F7



63NTA
Tube Support
p. F8



66NBH
Bulkhead Union
p. F8



66NTA
Female Connector
NPTF
p. F8



VS68NTA
Male Connector
NPTF
p. F8



68NTA-X-MIX
Male Connector
p. F8



VS176NTA
Adapter
NPTF
p. F8



264NTA
Union Tee
p. F9



265NTA
Union Elbow
p. F9



VS269NTA
Male Elbow
NPTF
p. F9



270NTA
Female Elbow
NPTF
p. F9



VS271NTA
Male Run Tee
NPTF
p. F9



VS272NTA
Male Branch Tee
NPTF
p. F10



VS279NTA
45° Male Elbow
NPTF
p. F10



■ Transmission Fittings

60TF
Sleeve
p. F12



61TF
Nut
p. F12



62TF
Union
p. F12



68TF
Male Connector
NPTF
p. F12



269TF
Male Elbow
NPTF
p. F12



■ Air Brake – AB Fittings

60AB
Sleeve
p. F14



61AB
Nut
p. F14



62AB
Union
p. F14



62ABH
Bulkhead Union
p. F14



66AB
Female Connector
NPTF
p. F14



VS68AB
Male Connector
NPTF
p. F14



264AB
Union Tee
p. F15



265AB
Union Elbow
p. F15



VS269AB
Male Elbow
NPTF
p. F15



270AB
Female Elbow
NPTF
p. F15



VS271AB
Male Run Tee
NPTF
p. F15



VS272AB
Male Branch Tee
NPTF
p. F16



VS279AB
45° Male Elbow
NPTF
p. F16



207ACBH
Anchor Coupling
NPTF
p. F16



⚠ WARNING These products can expose you to chemicals including NICKEL, CARBON BLACK, or LEAD, which are known to the state of California to cause cancer, and LEAD which is known to cause birth defects or other reproductive harm. For more information go to www.P65Warnings.ca.gov.

■ Air Brake Hose Ends Fittings

56RBSG
Spring
p. F18



60RB
Sleeve
p. F18



61RB
Nut
p. F18



61RBSG
Spring Guard Nut
p. F18



62RB
Union
p. F18



66RBSV
Female Connector
NPTF
p. F18



67RBSG
Nut & Spring
p. F18



68RB
Male Connector
NPTF
p. F18



68RB
Male Connector
Body Only – NPTF
p. F18



68RBSG
Male Connector
NPTF
p. F18



76RB
Adapter
NPTF
p. F18



■ Vibra-Lok Fittings

60VL
Sleeve
p. F20



60VLV
Sleeve
p. F20



61VL
Nut
p. F20



62VL
Union
p. F20



66VL
Female Connector
NPTF
p. F21



68VL
Male Connector
NPTF
p. F21



685VLV
Male Connector
p. F21



164VL
Union Tee
p. F21



169VL
Male Elbow
NPTF
p. F21



682VL
Tank Fitting
NPTF
p. F21



1695VL
Male Elbow
p. F22



170VL
Female Elbow
NPTF
p. F22



171VL
Male Run Tee
NPTF
p. F22



172VL
Male Branch Tee
NPTF
p. F22



179VL
45° Male Elbow
NPTF
p. F22



■ Truck Valves & Lanyard Valve

V404P
Hose – Pipe
p. F24



V404PH
Hose – Pipe
p. F24



SV404P
Hose – Pipe
p. F24



V405P
Female – Male
p. F24



V408NTA
Tube – Pipe
p. F24



V409F
Flare – Pipe
p. F24



V410NTA
Tube – Pipe
p. F24



V412F
Tube – Flare
p. F24



LV91
Lanyard Valve
p. F24



⚠ WARNING These products can expose you to chemicals including NICKEL, CARBON BLACK, or LEAD, which are known to the state of California to cause cancer, and LEAD which is known to cause birth defects or other reproductive harm. For more information go to www.P65Warnings.ca.gov.



A
B
C
D
E
F
G
H
I
J
K
L
M
N
O



Air Brake-NTA[®] Fittings

Parker's NTA Fittings utilize a ribbed sleeve for compression and positive grip. Fittings meet SAE and D.O.T. specifications. Designed for all D.O.T truck and trailer applications. Electroless nickel plated bodies can be used with bio-diesel.

Product Features:

- Brass Body
- Meets D.O.T. FMVSS571.106 Performance
- Meets functional Requirements SAE J246 & SAE J1131
- Pre-applied Thread Sealant
- Nickel Plated Versions Available for Bio-diesel

Markets:

- Heavy Duty Truck
- Trailer
- Mobile

Applications:

- Air Brakes
- Air Tanks
- Air Ride
- Sliders
- Tire Inflation
- Primary & Secondary Air Lines
- Cab Controls

Specifications:

Pressure Range Up to 150 PSI (10.3 bar)

Temperature Range -40° to +200° F (-40° to +93.3° C)

Compatible Tubing:

- SAE J844 Type A & B nylon tubing

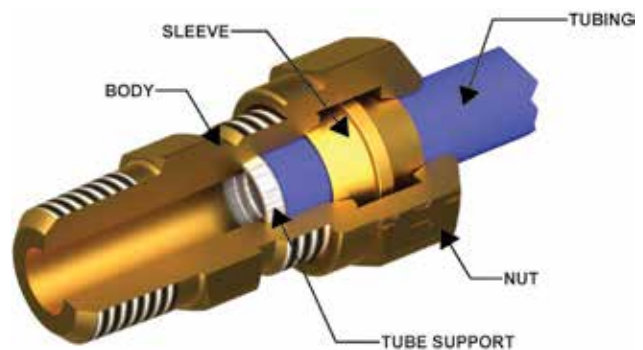

Assembly Instructions

1. Cut tubing squarely – maximum of 15° angle allowable.
2. Check that port or mating part is clean and free of debris.
3. Insert tubing until it bottoms on seat.
4. Tighten nut with wrench until one thread remains visible on the fitting body; (this will allow for a number of remakes) or, the nut should be screwed down finger tight, then wrench-tightened as indicated in the following table.

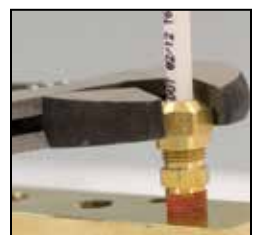

| TUBE SIZE | ADDITIONAL NUMBER OF TURNS FROM HAND-TIGHT |
|-----------|--|
| 3/16 | 2-1/2 |
| 1/4 | 3 |
| 3/8 & 1/2 | 4 |
| 5/8 & 3/4 | 3-1/2 |

WARNING These products can expose you to chemicals including NICKEL or LEAD, which are known to the state of California to cause cancer, and LEAD which is known to cause birth defects or other reproductive harm. For more information go to www.P65Warnings.ca.gov.



Click here for CADs, Product Specifications or to Configure Parts Online

Sleeve 60NTA

REF. SAE 100115



| PART NO. | TUBE SIZE | A | D | L |
|----------|-----------|------|------|-----|
| 60NTA-3* | 3/16 | .255 | .194 | .23 |
| 60NTA-4 | 1/4 | .359 | .256 | .30 |
| 60NTA-6 | 3/8 | .479 | .384 | .39 |
| 60NTA-8 | 1/2 | .624 | .509 | .43 |
| 60NTA-10 | 5/8 | .746 | .634 | .49 |
| 60NTA-12 | 3/4 | .922 | .760 | .54 |

*Meets D.O.T. FMVSS 571.106 specification. No applicable SAE specification for this tube size.

Nut 61NTA

REF. SAE 100110

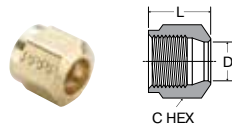

| PART NO. | TUBE SIZE | STRAIGHT THREAD | C HEX | D | L |
|----------|-----------|-----------------|-------|------|-----|
| 61NTA-3* | 3/16 | 5/16-24 | 7/16 | .194 | .40 |
| 61NTA-4 | 1/4 | 7/16-24 | 9/16 | .256 | .45 |
| 61NTA-6 | 3/8 | 17/32-24 | 5/8 | .384 | .63 |
| 61NTA-8 | 1/2 | 11/16-20 | 13/16 | .509 | .72 |
| 61NTA-10 | 5/8 | 13/16-18 | 15/16 | .634 | .77 |
| 61NTA-12 | 3/4 | 1-18 | 1-1/8 | .760 | .81 |

*Meets D.O.T. FMVSS 571.106 specification. No applicable SAE specification for this tube size.

Union 62NTA

REF. SAE 100101 BA

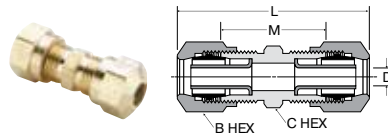

| PART NO. | TUBE SIZE | STRAIGHT THREAD | B HEX | C HEX | L | M | FLOW DIA. D |
|----------|-----------|-----------------|-------|-------|------|------|-------------|
| 62NTA-4 | 1/4 | 7/16-24 | 9/16 | 7/16 | 1.49 | .83 | .137 |
| 62NTA-6 | 3/8 | 17/32-24 | 5/8 | 9/16 | 2.00 | 1.08 | .217 |
| 62NTA-8 | 1/2 | 11/16-20 | 13/16 | 11/16 | 2.32 | 1.29 | .338 |
| 62NTA-10 | 5/8 | 13/16-18 | 15/16 | 13/16 | 2.39 | 1.41 | .398 |
| 62NTA-12 | 3/4 | 1-18 | 1-1/8 | 1 | 2.60 | 1.58 | .523 |

Bulkhead Union 62ANBH

(NTA® & AIR BRAKE)

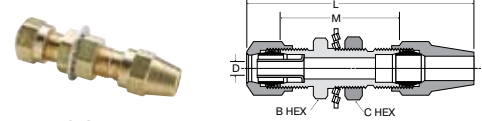

| PART NO. | TUBE SIZE | STRAIGHT THREAD | B HEX | C HEX | L | M | FLOW DIA. D | BULKHEAD HOLE DIA. |
|----------|-----------|-----------------|-------|-------|------|------|-------------|--------------------|
| 62ANBH-4 | 1/4 | 7/16-24 | 9/16 | 9/16 | 2.28 | 1.38 | .137 | 7/16 |
| 62ANBH-6 | 3/8 | 17/32-24 | 11/16 | 3/4 | 2.97 | 1.62 | .217 | 17/32 |
| 62ANBH-8 | 1/2 | 11/16-20 | 13/16 | 1 | 3.36 | 1.88 | .338 | 11/16 |

Bulkhead Union 62NBH

| PART NO. | TUBE SIZE | STRAIGHT THREAD | B HEX | C HEX | L | M | FLOW DIA. D | BULKHEAD HOLE DIA. |
|----------|-----------|-----------------|-------|-------|------|------|-------------|--------------------|
| 62NBH-3* | 3/16 | 5/16-24 | 7/16 | 7/16 | 1.80 | 1.21 | .087 | 5/16 |
| 62NBH-4 | 1/4 | 7/16-24 | 9/16 | 9/16 | 2.04 | 1.38 | .137 | 7/16 |
| 62NBH-6 | 3/8 | 17/32-24 | 11/16 | 3/4 | 2.54 | 1.62 | .217 | 17/32 |
| 62NBH-8 | 1/2 | 11/16-20 | 13/16 | 1 | 2.92 | 1.88 | .338 | 11/16 |
| 62NBH-10 | 5/8 | 13/16-18 | 15/16 | 1 | 2.99 | 2.01 | .398 | 13/16 |

*Meets D.O.T. FMVSS 571.106 specification. No applicable SAE specification for this tube size.

Bulkhead Union 62NFBH

| PART NO. | TUBE SIZE | FLARE SIZE | STGHT THD | B HEX | C HEX | L | M | FLOW DIA. D | BKHD HOLE DIA. |
|-------------|-----------|------------|-----------|-------|-------|------|------|-------------|----------------|
| 62NFBH-4 | 1/4 | 1/4 | 7/16-24 | 9/16 | 9/16 | 1.86 | 1.53 | .137 | 7/16 |
| 62NFBH-6 | 3/8 | 3/8 | 17/32-24 | 3/4 | 3/4 | 2.24 | 1.78 | .217 | 5/8 |
| 62NFBH-8 | 1/2 | 1/2 | 11/16-20 | 7/8 | 7/8 | 2.73 | 2.22 | .338 | 3/4 |
| 62NFBH-10 | 5/8 | 5/8 | 13/16-18 | 1 | 1 | 2.68 | 2.21 | .398 | 7/8 |
| 62NFBH-10-8 | 5/8 | 1/2 | 13/16-18 | 7/8 | 7/8 | 2.90 | 2.40 | .398 | 3/4 |

WARNING These products can expose you to chemicals including NICKEL or LEAD, which are known to the state of California to cause cancer, and LEAD which is known to cause birth defects or other reproductive harm. For more information go to www.P65Warnings.ca.gov.



[Click here for CADs, Product Specifications or to Configure Parts Online](#)

- A
- B
- C
- D
- E
- F
- G
- H
- I
- J
- K
- L
- M
- N
- O



Stainless Steel Insert 63NTA

(FOR SAE J844 TUBING)

| PART NO. | TUBE SIZE | L | O.D. |
|----------|-----------|------|------|
| 63NTA-4 | 1/4 | .53 | .163 |
| 63NTA-6 | 3/8 | .64 | .245 |
| 63NTA-8 | 1/2 | .81 | .370 |
| 63NTA-10 | 5/8 | .86 | .434 |
| 63NTA-12 | 3/4 | 1.04 | .559 |

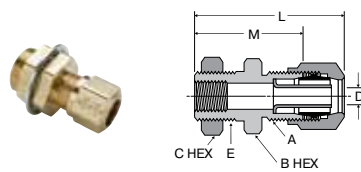

Male Connector VS68NTA

Ref. SAE 100102 BA

| PART NO. | TUBE SIZE | PIPE THREAD | STRAIGHT THREAD | C HEX | L | M | FLOW DIA. D |
|---------------|-----------|-------------|-----------------|-------|------|------|-------------|
| VS68NTA-3-1* | 3/16 | 1/16 | 5/16-24 | 3/8 | 1.16 | .87 | .087 |
| VS68NTA-3-2* | 3/16 | 1/8 | 5/16-24 | 7/16 | 1.15 | .86 | .087 |
| VS68NTA-3-4* | 3/16 | 1/4 | 5/16-24 | 9/16 | 1.35 | 1.05 | .087 |
| VS68NTA-4-2 | 1/4 | 1/8 | 7/16-24 | 7/16 | 1.22 | .89 | .137 |
| VS68NTA-4-4 | 1/4 | 1/4 | 7/16-24 | 9/16 | 1.43 | 1.10 | .137 |
| VS68NTA-4-6 | 1/4 | 3/8 | 7/16-24 | 11/16 | 1.47 | 1.14 | .137 |
| VS68NTA-6-2 | 3/8 | 1/8 | 17/32-24 | 9/16 | 1.49 | 1.03 | .217 |
| VS68NTA-6-4 | 3/8 | 1/4 | 17/32-24 | 9/16 | 1.67 | 1.21 | .217 |
| VS68NTA-6-6 | 3/8 | 3/8 | 17/32-24 | 11/16 | 1.70 | 1.24 | .217 |
| VS68NTA-6-8 | 3/8 | 1/2 | 17/32-24 | 7/8 | 1.89 | 1.43 | .217 |
| VS68NTA-8-4 | 1/2 | 1/4 | 11/16-20 | 11/16 | 1.85 | 1.33 | .338 |
| VS68NTA-8-6 | 1/2 | 3/8 | 11/16-20 | 11/16 | 1.85 | 1.33 | .338 |
| VS68NTA-8-8 | 1/2 | 1/2 | 11/16-20 | 7/8 | 2.04 | 1.52 | .338 |
| VS68NTA-10-6 | 5/8 | 3/8 | 13/16-18 | 13/16 | 1.88 | 1.39 | .398 |
| VS68NTA-10-8 | 5/8 | 1/2 | 13/16-18 | 7/8 | 2.10 | 1.58 | .398 |
| VS68NTA-12-6 | 3/4 | 3/8 | 1-18 | 1 | 2.00 | 1.49 | .440 |
| VS68NTA-12-8 | 3/4 | 1/2 | 1-18 | 1 | 2.19 | 1.68 | .523 |
| VS68NTA-12-12 | 3/4 | 3/4 | 1-18 | 1-1/8 | 2.22 | 1.71 | .523 |

Bulkhead Union 66NBH

| PART NO. | TB SZ | PIPE THD | A STGHT THD | E STGHT THD | B HEX | C HEX | L | M | FLOW DIA. D | BKHD HOLE DIA. |
|-----------|-------|----------|-------------|-------------|--------|--------|------|------|-------------|----------------|
| 66NBH-8-6 | 1/2 | 3/8 | 11/16-20 | 7/8-14 | 1-1/16 | 1-1/16 | 1.94 | 1.42 | .338 | 7/8 |

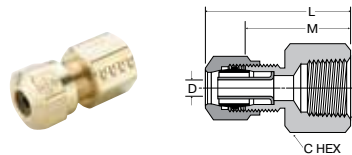

Female Connector 66NTA

REF. SAE 100103 BA

| PART NO. | TUBE SIZE | PIPE THREAD | STRAIGHT THREAD | C HEX | L | M | FLOW DIA. D |
|------------|-----------|-------------|-----------------|--------|------|------|-------------|
| 66NTA-4-2 | 1/4 | 1/8 | 7/16-24 | 9/16 | 1.17 | .84 | .137 |
| 66NTA-4-4 | 1/4 | 1/4 | 7/16-24 | 11/16 | 1.40 | 1.07 | .137 |
| 66NTA-6-2 | 3/8 | 1/8 | 17/32-24 | 9/16 | 1.46 | 1.00 | .217 |
| 66NTA-6-4 | 3/8 | 1/4 | 17/32-24 | 11/16 | 1.64 | 1.18 | .217 |
| 66NTA-6-6 | 3/8 | 3/8 | 17/32-24 | 7/8 | 1.64 | 1.18 | .217 |
| 66NTA-8-6 | 1/2 | 3/8 | 11/16-20 | 7/8 | 1.79 | 1.27 | .338 |
| 66NTA-8-8 | 1/2 | 1/2 | 11/16-20 | 1-1/16 | 1.96 | 1.44 | .338 |
| 66NTA-10-6 | 5/8 | 3/8 | 13/16-18 | 7/8 | 1.80 | 1.31 | .398 |
| 66NTA-10-8 | 5/8 | 1/2 | 13/16-18 | 1-1/16 | 1.99 | 1.50 | .398 |

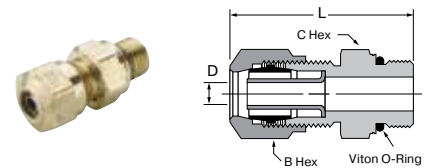

NTA® to Metric Adaptor 68NTA-X-MIX

| PART NO. | TUBE SIZE | METRIC THREAD | B HEX | C HEX | L | D |
|-------------|-----------|---------------|-------|-------|------|------|
| 68NTA-4-M10 | 1/4 | M10 X 1.0 | 9/16 | 9/16 | 1.33 | .140 |

Note: Fluorocarbon o-ring is standard

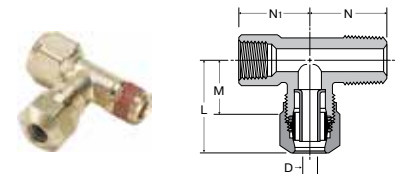

Adapter Tee VS176NTA

| PART NO. | TUBE SIZE | PIPE THREAD | STRAIGHT THREAD | L | M | N | N1 | FLOW DIA. D |
|--------------|-----------|-------------|-----------------|------|-----|-----|-----|-------------|
| VS176NTA-4-2 | 1/4 | 1/8 | 7/16-24 | 1.02 | .69 | .75 | .66 | .137 |

WARNING These products can expose you to chemicals including NICKEL or LEAD, which are known to the state of California to cause cancer, and LEAD which is known to cause birth defects or other reproductive harm. For more information go to www.P65Warnings.ca.gov.

Click here for CADs, Product Specifications or to Configure Parts Online

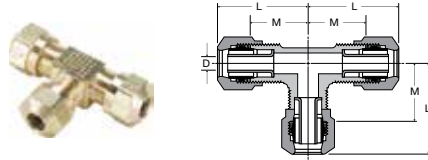

Union Tee 264NTA

REF. SAE 100401 BA

| PART NO. | TUBE SIZE | STRAIGHT THREAD | L | M | FLOW DIA. D |
|-----------|-----------|-----------------|------|------|-------------|
| 264NTA-4 | 1/4 | 7/16-24 | .95 | .62 | .137 |
| 264NTA-6 | 3/8 | 17/32-24 | 1.24 | .78 | .217 |
| 264NTA-8 | 1/2 | 11/16-20 | 1.45 | .93 | .338 |
| 264NTA-10 | 5/8 | 13/16-18 | 1.58 | 1.09 | .398 |

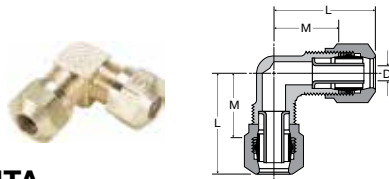

Union Elbow 265NTA

REF. SAE 100201 BA

| PART NO. | TUBE SIZE | STRAIGHT THREAD | L | M | FLOW DIA. D |
|-----------|-----------|-----------------|------|------|-------------|
| 265NTA-4 | 1/4 | 7/16-24 | .95 | .62 | .137 |
| 265NTA-6 | 3/8 | 17/32-24 | 1.25 | .79 | .217 |
| 265NTA-8 | 1/2 | 11/16-20 | 1.45 | .93 | .338 |
| 265NTA-10 | 5/8 | 13/16-18 | 1.58 | 1.09 | .398 |

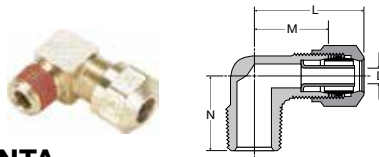

Male Elbow VS269NTA

REF. SAE 100202 BA

| PART NO. | TUBE SIZE | PIPE THREAD | STRAIGHT THREAD | L | M | N | FLOW DIA. D |
|----------------|-----------|-------------|-----------------|------|------|------|-------------|
| VS269NTA-3-2* | 3/16 | 1/8 | 5/16-24 | .90 | .60 | .67 | .087 |
| VS269NTA-3-4* | 3/16 | 1/4 | 5/16-24 | .91 | .62 | .87 | .087 |
| VS269NTA-4-2 | 1/4 | 1/8 | 7/16-24 | .95 | .62 | .66 | .137 |
| VS269NTA-4-4 | 1/4 | 1/4 | 7/16-24 | 1.00 | .68 | .87 | .137 |
| VS269NTA-4-6 | 1/4 | 3/8 | 7/16-24 | 1.16 | .73 | .86 | .137 |
| VS269NTA-6-2 | 3/8 | 1/8 | 17/32-24 | 1.19 | .73 | .75 | .217 |
| VS269NTA-6-4 | 3/8 | 1/4 | 17/32-24 | 1.25 | .79 | .92 | .217 |
| VS269NTA-6-6 | 3/8 | 3/8 | 17/32-24 | 1.30 | .84 | .91 | .217 |
| VS269NTA-6-8 | 3/8 | 1/2 | 17/32-24 | 1.40 | .94 | 1.10 | .217 |
| VS269NTA-8-4 | 1/2 | 1/4 | 11/16-20 | 1.38 | .86 | .99 | .338 |
| VS269NTA-8-6 | 1/2 | 3/8 | 11/16-20 | 1.44 | .92 | .99 | .338 |
| VS269NTA-8-8 | 1/2 | 1/2 | 11/16-20 | 1.55 | 1.03 | 1.18 | .338 |
| VS269NTA-10-6 | 5/8 | 3/8 | 13/16-18 | 1.49 | 1.00 | 1.05 | .398 |
| VS269NTA-10-8 | 5/8 | 1/2 | 13/16-18 | 1.58 | 1.09 | 1.24 | .398 |
| VS269NTA-10-12 | 5/8 | 3/4 | 13/16-18 | 1.76 | 1.25 | 1.32 | .400 |
| VS269NTA-12-8 | 3/4 | 1/2 | 1-18 | 1.70 | 1.19 | 1.33 | .523 |
| VS269NTA-12-12 | 3/4 | 3/4 | 1-18 | 1.77 | 1.26 | 1.32 | .523 |

*Meets D.O.T. FMVSS 571.106 specification. No applicable SAE specification for this tube size.

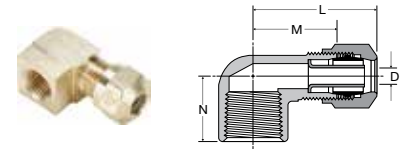

Female Elbow 270NTA

REF. SAE 100203 BA

| PART NO. | TUBE SIZE | PIPE THREAD | STRAIGHT THREAD | L | M | N | FLOW DIA. D |
|-------------|-----------|-------------|-----------------|------|------|------|-------------|
| 270NTA-3-2* | 3/16 | 1/8 | 5/16-24 | .96 | .67 | .52 | .087 |
| 270NTA-4-2 | 1/4 | 1/8 | 7/16-24 | 1.02 | .69 | .52 | .137 |
| 270NTA-4-4 | 1/4 | 1/4 | 7/16-24 | 1.11 | .78 | .71 | .137 |
| 270NTA-6-2 | 3/8 | 1/8 | 17/32-24 | 1.29 | .83 | .59 | .217 |
| 270NTA-6-4 | 3/8 | 1/4 | 17/32-24 | 1.35 | .89 | .77 | .217 |
| 270NTA-6-6 | 3/8 | 3/8 | 17/32-24 | 1.39 | .93 | .77 | .217 |
| 270NTA-8-6 | 1/2 | 3/8 | 11/16-20 | 1.55 | 1.03 | .82 | .338 |
| 270NTA-8-8 | 1/2 | 1/2 | 11/16-20 | 1.65 | 1.13 | 1.01 | .338 |
| 270NTA-10-8 | 5/8 | 1/2 | 13/16-18 | 1.70 | 1.19 | 1.07 | .398 |

*Meets D.O.T. FMVSS 571.106 specification. No applicable SAE specification for this tube size.

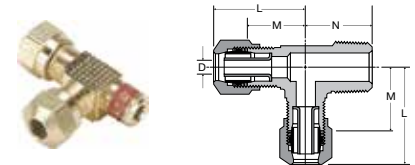

Male Run Tee VS271NTA

REF. SAE 100424 BA

| PART NO. | TUBE SIZE | PIPE THREAD | STRAIGHT THREAD | L | M | N | FLOW DIA. D |
|---------------|-----------|-------------|-----------------|------|------|------|-------------|
| VS271NTA-4-2 | 1/4 | 1/8 | 7/16-24 | .95 | .62 | .66 | .137 |
| VS271NTA-4-4 | 1/4 | 1/4 | 7/16-24 | 1.00 | .68 | .87 | .137 |
| VS271NTA-6-4 | 3/8 | 1/4 | 17/32-24 | 1.25 | .79 | .92 | .217 |
| VS271NTA-6-6 | 3/8 | 3/8 | 17/32-24 | 1.30 | .84 | .91 | .217 |
| VS271NTA-8-6 | 1/2 | 3/8 | 11/16-20 | 1.45 | .93 | .99 | .338 |
| VS271NTA-8-8 | 1/2 | 1/2 | 11/16-20 | 1.55 | 1.03 | 1.18 | .338 |
| VS271NTA-10-8 | 5/8 | 1/2 | 13/16-18 | 1.60 | 1.09 | 1.24 | .398 |

WARNING These products can expose you to chemicals including NICKEL or LEAD, which are known to the state of California to cause cancer, and LEAD which is known to cause birth defects or other reproductive harm. For more information go to www.P65Warnings.ca.gov.



Click here for CADs, Product Specifications or to Configure Parts Online

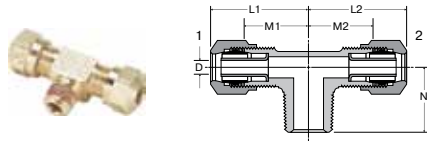

Male Branch Tee VS272NTA

REF. SAE 100425 BA

| PART NO. | TB 1 | TB 2 | PIPE THD | STGHT THD | L1 | L2 | M1 | M2 | N | FLOW DIA. D |
|----------------|------|------|----------|-----------|------|------|------|------|------|-------------|
| VS272NTA-3-2* | 3/16 | 3/16 | 1/8 | 5/16-24 | .90 | .90 | .61 | .61 | .66 | .087 |
| VS272NTA-4-2 | 1/4 | 1/4 | 1/8 | 7/16-24 | .95 | .95 | .62 | .62 | .66 | .137 |
| VS272NTA-4-4 | 1/4 | 1/4 | 1/4 | 7/16-24 | 1.00 | 1.00 | .68 | .68 | .87 | .137 |
| VS272NTA-6-2 | 3/8 | 3/8 | 1/8 | 17/32-24 | 1.18 | 1.18 | .75 | .75 | .73 | .217 |
| VS272NTA-6-4 | 3/8 | 3/8 | 1/4 | 17/32-24 | 1.25 | 1.25 | .91 | .91 | .92 | .217 |
| VS272NTA-6-4-4 | 3/8 | 1/4 | 1/4 | 7/16-24 | .99 | 1.25 | .67 | .79 | .91 | .137 |
| | | | | 17/32-24 | | | | | | |
| VS272NTA-6-6 | 3/8 | 3/8 | 3/8 | 17/32-24 | 1.27 | 1.27 | .84 | .84 | .91 | .217 |
| VS272NTA-8-4 | 1/2 | 1/2 | 1/4 | 11/16-20 | 1.45 | 1.45 | .93 | .93 | .99 | .338 |
| VS272NTA-8-6 | 1/2 | 1/2 | 3/8 | 11/16-20 | 1.45 | 1.45 | .93 | .93 | .99 | .338 |
| VS272NTA-8-8 | 1/2 | 1/2 | 1/2 | 11/16-20 | 1.55 | 1.55 | 1.03 | 1.03 | 1.18 | .338 |
| VS272NTA-10-8 | 5/8 | 5/8 | 1/2 | 13/16-18 | 1.60 | 1.60 | 1.09 | 1.09 | 1.24 | .398 |

*Meets D.O.T. FMVSS 571.106 specification. No applicable SAE specification for this tube size.

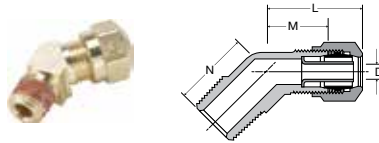

45° Elbow VS279NTA

REF. SAE 100302 BA

| PART NO. | TUBE SIZE | PIPE THREAD | STRAIGHT THREAD | L | M | N | FLOW DIA. D |
|---------------|-----------|-------------|-----------------|------|------|------|-------------|
| VS279NTA-4-2 | 1/4 | 1/8 | 7/16-24 | .81 | .49 | .63 | .137 |
| VS279NTA-4-4 | 1/4 | 1/4 | 7/16-24 | .93 | .60 | .85 | .137 |
| VS279NTA-6-2 | 3/8 | 1/8 | 17/32-24 | 1.17 | .71 | .68 | .217 |
| VS279NTA-6-4 | 3/8 | 1/4 | 17/32-24 | 1.17 | .71 | .85 | .217 |
| VS279NTA-6-6 | 3/8 | 3/8 | 17/32-24 | 1.21 | .75 | .94 | .217 |
| VS279NTA-6-8 | 3/8 | 1/2 | 17/32-24 | 1.24 | .78 | 1.16 | .217 |
| VS279NTA-8-4 | 1/2 | 1/4 | 11/16-20 | 1.36 | .84 | .94 | .338 |
| VS279NTA-8-6 | 1/2 | 3/8 | 11/16-20 | 1.36 | .84 | .94 | .338 |
| VS279NTA-8-8 | 1/2 | 1/2 | 11/16-20 | 1.39 | .87 | 1.16 | .338 |
| VS279NTA-10-6 | 5/8 | 3/8 | 13/16-18 | 1.43 | .94 | .98 | .398 |
| VS279NTA-10-8 | 5/8 | 1/2 | 13/16-18 | 1.42 | .93 | 1.16 | .398 |
| VS279NTA-12-8 | 3/4 | 1/2 | 1-18 | 1.61 | 1.10 | 1.18 | .523 |

WARNING These products can expose you to chemicals including NICKEL or LEAD, which are known to the state of California to cause cancer, and LEAD which is known to cause birth defects or other reproductive harm. For more information go to www.P65Warnings.ca.gov.





Transmission Fittings

Parker's Transmission Fittings utilizes a specially designed slotted sleeve to help eliminate notch stress related to over-torque. Ideal for pressure protected pneumatic transmission applications. Electroless nickel plated bodies can be used with bio-diesel.

Product Features:

- Brass Body
- D.O.T. Approved with Staked in Tube Support
- 3/16" & 5/32" Tube sizes
- Slotted Sleeve
- Nickel Plated Versions Available for Bio-diesel

Markets:

- Heavy Duty Truck

Applications:

- Air Shift Transmissions
- Seat Controls
- Dash Controls

Specifications:

Pressure Range Up to 150 PSI (10.3 bar)

Temperature Range -40° to +200° F (-40° to +93.3° C)

Compatible Tubing:

- SAE J844 Type A & B nylon tubing

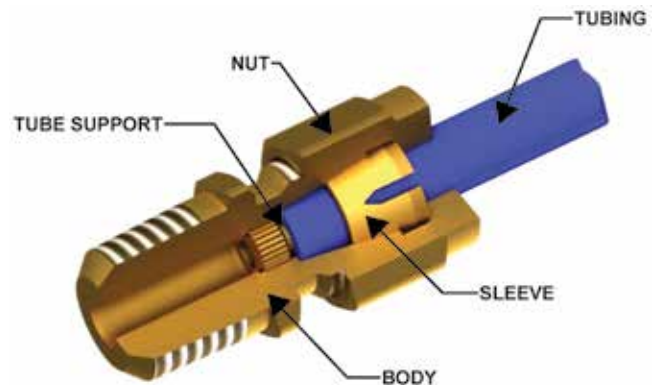

Assembly Instructions

1. Cut tubing squarely and remove burrs
2. Insert tubing into fitting until bottomed
3. Tighten nut 1 1/2 turns from finger tight



WARNING These products can expose you to chemicals including LEAD which is known to the state of California to cause cancer and birth defects or other reproductive harm. For more information go to www.P65Warnings.ca.gov.



Click here for CADs, Product Specifications or to Configure Parts Online

- A
- B
- C
- D
- E
- F
- G
- H
- I
- J
- K
- L
- M
- N
- O

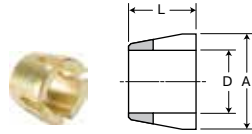

Sleeve 60TF

| PART NO. | TUBE SIZE | A | D | L |
|-----------|-----------|------|------|------|
| 60TF-2 | 1/8 | .235 | .130 | 0.17 |
| 60TF-5/32 | 5/32 | .251 | .165 | 0.18 |

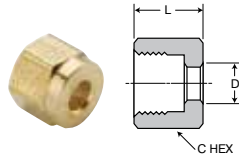

Nut 61TF

| PART NO. | TUBE SIZE | D | L | STRT THD | C HEX |
|-----------|-----------|------|-----|----------|-------|
| 61TF-2 | 1/8 | .133 | .32 | 5/16-24 | 3/8 |
| 61TF-5/32 | 5/32 | .163 | .32 | 5/16-24 | 3/8 |

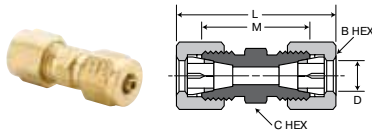

Union 62TF

| PART NO. | TUBE SIZE | D | L | STRT THD | M | C HEX | B HEX |
|-----------|-----------|------|------|----------|-----|-------|-------|
| 62TF-2 | 1/8 | .109 | 1.04 | 5/16-24 | .68 | 5/16 | 3/8 |
| 62TF-5/32 | 5/32 | .068 | 1.04 | 5/16-24 | .68 | 5/16 | 3/8 |

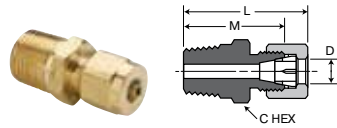

Male Connector 68TF

| PART NO. | TUBE SIZE | PIPE THREAD | D | L | STRT THD | M | C HEX |
|-------------|-----------|-------------|------|-----|----------|-----|-------|
| 68TF-2-1 | 1/8 | 1/16 | .109 | .96 | 5/16-24 | .78 | 11/32 |
| 68TF-2-2 | 1/8 | 1/8 | .109 | .96 | 5/16-24 | .78 | 7/16 |
| 68TF-5/32-1 | 5/32 | 1/16 | .068 | .84 | 5/16-24 | .66 | 11/32 |
| 68TF-5/32-2 | 5/32 | 1/8 | .068 | .96 | 5/16-24 | .78 | 7/16 |

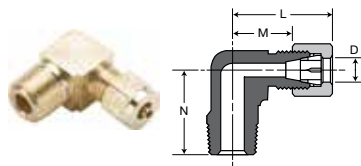

Male Elbow 269TF

| PART NO. | TUBE SIZE | PIPE THREAD | D | L | STRT THD | M | N |
|--------------|-----------|-------------|------|-----|----------|-----|-----|
| 269TF-2-2 | 1/8 | 1/8 | .109 | .79 | 5/16-24 | .61 | .66 |
| 269TF-5/32-2 | 5/32 | 1/8 | .068 | .79 | 5/16-24 | .61 | .66 |

WARNING These products can expose you to chemicals including LEAD which is known to the state of California to cause cancer and birth defects or other reproductive harm. For more information go to www.P65Warnings.ca.gov.

- A
- B
- C
- D
- E
- F
- G
- H
- I
- J
- K
- L
- M
- N
- O



Air Brake – AB Fittings

Parker’s Air Brake – AB Fittings are economical compression style fittings for copper air brake lines. AB fittings meet the functional requirements of SAE and the performance requirements of D.O.T.

Product Features:

- Brass Body
- Meets D.O.T. FMVSS571.106 Performance
- Meets functional Requirements SAE J246
- Reusable
- Pre-applied Thread Sealant

Markets:

- Heavy Duty Truck
- Trailer
- Mobile

Applications:

- Copper Air Brake Lines
- Coolant Lines
- Fuel Lines

Specifications:

Pressure Range Up to 400 PSI (27.5 bar)

Temperature Range -65° to +250° F (-53.8° to +121.1° C)

Compatible Tubing:

- Copper Air Brake Tubing

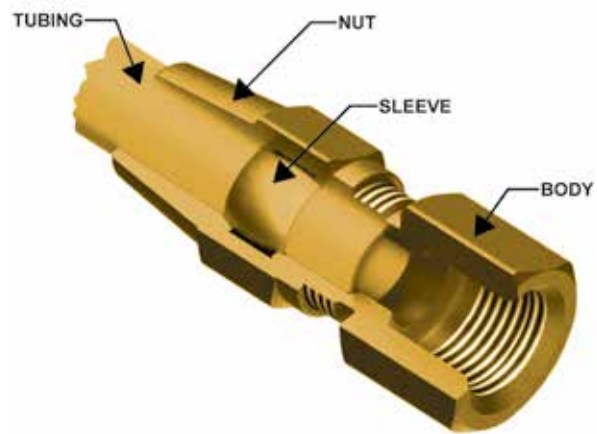

Assembly Instructions

1. Cut tubing squarely and remove burrs
2. Slide nut and sleeve onto tubing.
3. Insert tubing into fitting until bottomed on seat. The nut should be screwed down finger tight, then wrench tightened as indicated in the chart

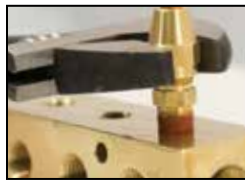

| TUBE SIZE | TURNS REQUIRED TO SEAL FROM HAND-TIGHT |
|---------------|--|
| 1/4, 3/8, 1/2 | 2 |
| 5/8, 3/4 | 3 |

WARNING These products can expose you to chemicals including LEAD which is known to the state of California to cause cancer and birth defects or other reproductive harm. For more information go to www.P65Warnings.ca.gov.

[Click here for CADs, Product Specifications or to Configure Parts Online](#)

- A
- B
- C
- D
- E
- F
- G
- H
- I
- J
- K
- L
- M
- N
- O

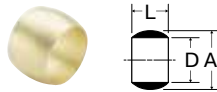

Sleeve 60AB

REF. SAE 120115

| PART NO. | TUBE SIZE | A | D | L |
|----------|-----------|------|------|------|
| 60AB-4 | 1/4 | .322 | .255 | .250 |
| 60AB-6 | 3/8 | .461 | .382 | .310 |
| 60AB-8 | 1/2 | .594 | .507 | .380 |
| 60AB-10 | 5/8 | .734 | .632 | .440 |
| 60AB-12 | 3/4 | .874 | .758 | .500 |

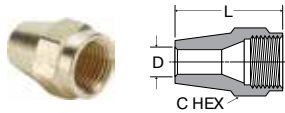

Female Connector 66AB

REF. SAE 120103 BA

| PART NO. | TUBE SIZE | PIPE THREAD | STRAIGHT THREAD | C HEX | L | M | FLOW DIA. D |
|-----------|-----------|-------------|-----------------|--------|------|------|-------------|
| 66AB-4-2 | 1/4 | 1/8 | 7/16-24 | 9/16 | 1.42 | .84 | .188 |
| 66AB-4-4 | 1/4 | 1/4 | 7/16-24 | 11/16 | 1.65 | 1.07 | .188 |
| 66AB-6-2 | 3/8 | 1/8 | 17/32-24 | 9/16 | 1.89 | 1.00 | .314 |
| 66AB-6-4 | 3/8 | 1/4 | 17/32-24 | 11/16 | 2.07 | 1.18 | .314 |
| 66AB-6-6 | 3/8 | 3/8 | 17/32-24 | 7/8 | 2.07 | 1.18 | .314 |
| 66AB-8-6 | 1/2 | 3/8 | 11/16-20 | 7/8 | 2.23 | 1.27 | .408 |
| 66AB-8-8 | 1/2 | 1/2 | 11/16-20 | 1-1/16 | 2.40 | 1.44 | .408 |
| 66AB-10-6 | 5/8 | 3/8 | 13/16-18 | 7/8 | 2.40 | 1.31 | .533 |
| 66AB-10-8 | 5/8 | 1/2 | 13/16-18 | 1-1/16 | 2.59 | 1.50 | .533 |

Nut 61AB

REF. SAE 120111

| PART NO. | TUBE SIZE | STRAIGHT THREAD | C HEX | D | L |
|----------|-----------|-----------------|-------|------|------|
| 61AB-4 | 1/4 | 7/16-24 | 9/16 | .256 | .75 |
| 61AB-6 | 3/8 | 17/32-24 | 5/8 | .384 | 1.13 |
| 61AB-8 | 1/2 | 11/16-20 | 13/16 | .509 | 1.25 |
| 61AB-10 | 5/8 | 13/16-18 | 15/16 | .634 | 1.38 |
| 61AB-12 | 3/4 | 1-18 | 1-1/8 | .760 | 1.56 |

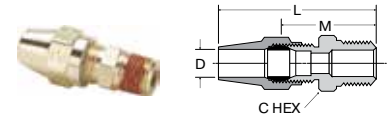

Male Connector VS68AB

REF. SAE 120102 BA

| PART NO. | TUBE SIZE | PIPE THREAD | STRAIGHT THREAD | C HEX | L | M | FLOW DIA. D |
|--------------|-----------|-------------|-----------------|-------|------|------|-------------|
| VS68AB-4-2 | 1/4 | 1/8 | 7/16-24 | 7/16 | 1.47 | .89 | .189 |
| VS68AB-4-4 | 1/4 | 1/4 | 7/16-24 | 9/16 | 1.68 | 1.10 | .189 |
| VS68AB-4-6 | 1/4 | 3/8 | 7/16-24 | 11/16 | 1.72 | 1.14 | .189 |
| VS68AB-6-2 | 3/8 | 1/8 | 17/32-24 | 9/16 | 1.92 | 1.03 | .189 |
| VS68AB-6-4 | 3/8 | 1/4 | 17/32-24 | 9/16 | 2.10 | 1.21 | .314 |
| VS68AB-6-6 | 3/8 | 3/8 | 17/32-24 | 11/16 | 2.13 | 1.24 | .314 |
| VS68AB-6-8 | 3/8 | 1/2 | 17/32-24 | 7/8 | 2.32 | 1.43 | .314 |
| VS68AB-8-4 | 1/2 | 1/4 | 11/16-20 | 11/16 | 2.29 | 1.33 | .314 |
| VS68AB-8-6 | 1/2 | 3/8 | 11/16-20 | 11/16 | 2.29 | 1.33 | .408 |
| VS68AB-8-8 | 1/2 | 1/2 | 11/16-20 | 7/8 | 2.48 | 1.52 | .408 |
| VS68AB-10-6 | 5/8 | 3/8 | 13/16-18 | 13/16 | 2.48 | 1.39 | .408 |
| VS68AB-10-8 | 5/8 | 1/2 | 13/16-18 | 7/8 | 2.67 | 1.58 | .533 |
| VS68AB-12-8 | 3/4 | 1/2 | 1-18 | 1 | 2.92 | 1.68 | .533 |
| VS68AB-12-12 | 3/4 | 3/4 | 1-18 | 1-1/8 | 2.95 | 1.71 | .658 |

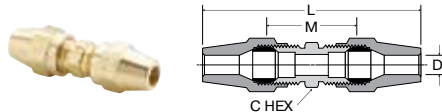

Union 62AB

REF. SAE 120101 BA

| PART NO. | TUBE SIZE | STRAIGHT THREAD | C HEX | L | M | FLOW DIA. D |
|----------|-----------|-----------------|-------|------|------|-------------|
| 62AB-4 | 1/4 | 7/16-24 | 7/16 | 1.98 | .83 | .189 |
| 62AB-6 | 3/8 | 17/32-24 | 9/16 | 2.87 | 1.08 | .314 |
| 62AB-8 | 1/2 | 11/16-20 | 11/16 | 3.21 | 1.29 | .405 |
| 62AB-10 | 5/8 | 13/16-18 | 13/16 | 3.59 | 1.41 | .531 |
| 62AB-12 | 3/4 | 1-18 | 1 | 4.08 | 1.59 | .656 |

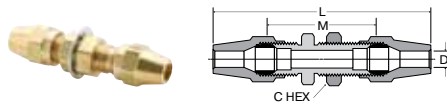

Bulkhead Union 62ABH

| PART NO. | TUBE SIZE | STRAIGHT THREAD | C HEX | L | M | FLOW DIA. D | BULKHEAD HOLE DIA. |
|----------|-----------|-----------------|-------|------|------|-------------|--------------------|
| 62ABH-4 | 1/4 | 7/16-24 | 9/16 | 2.53 | 1.38 | .188 | 7/16 |
| 62ABH-6 | 3/8 | 17/32-24 | 3/4 | 3.41 | 1.62 | .314 | 17/32 |
| 62ABH-8 | 1/2 | 11/16-20 | 1 | 3.80 | 1.88 | .408 | 11/16 |

WARNING These products can expose you to chemicals including LEAD which is known to the state of California to cause cancer and birth defects or other reproductive harm. For more information go to www.P65Warnings.ca.gov.

Click here for CADs, Product Specifications or to Configure Parts Online

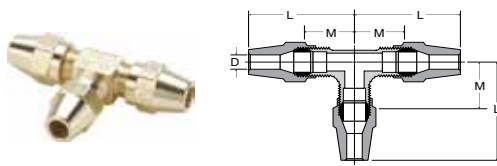

Union Tee 264AB

REF. SAE 120401 BA

| PART NO. | TUBE SIZE | STRAIGHT THREAD | L | M | FLOW DIA. D |
|----------|-----------|-----------------|------|------|-------------|
| 264AB-4 | 1/4 | 7/16-24 | 1.20 | .62 | .189 |
| 264AB-6 | 3/8 | 17/32-24 | 1.67 | .78 | .314 |
| 264AB-8 | 1/2 | 11/16-20 | 1.89 | .93 | .408 |
| 264AB-10 | 5/8 | 13/16-18 | 2.18 | 1.09 | .533 |

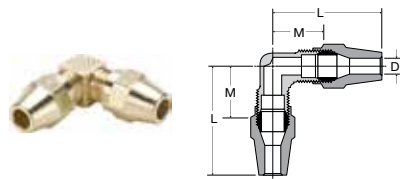

Union Elbow 265AB

REF. SAE 120201 BA

| PART NO. | TUBE SIZE | STRAIGHT THREAD | L | M | FLOW DIA. D |
|----------|-----------|-----------------|------|------|-------------|
| 265AB-4 | 1/4 | 7/16-24 | 1.20 | .62 | .189 |
| 265AB-6 | 3/8 | 17/32-24 | 1.68 | .79 | .314 |
| 265AB-8 | 1/2 | 11/16-20 | 1.89 | .93 | .408 |
| 265AB-10 | 5/8 | 13/16-18 | 2.18 | 1.09 | .533 |

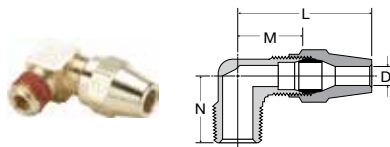

Male Elbow VS269AB

REF. SAE 120202 BA

| PART NO. | TUBE SIZE | PIPE THREAD | STRAIGHT THREAD | L | M | N | FLOW DIA. D |
|---------------|-----------|-------------|-----------------|------|------|------|-------------|
| VS269AB-4-2 | 1/4 | 1/8 | 7/16-24 | 1.20 | .62 | .66 | .189 |
| VS269AB-4-4 | 1/4 | 1/4 | 7/16-24 | 1.26 | .68 | .87 | .189 |
| VS269AB-4-6 | 1/4 | 3/8 | 7/16-24 | 1.31 | .73 | .86 | .189 |
| VS269AB-6-2 | 3/8 | 1/8 | 17/32-24 | 1.62 | .73 | .75 | .189 |
| VS269AB-6-4 | 3/8 | 1/4 | 17/32-24 | 1.68 | .79 | .92 | .314 |
| VS269AB-6-6 | 3/8 | 3/8 | 17/32-24 | 1.73 | .84 | .91 | .314 |
| VS269AB-6-8 | 3/8 | 1/2 | 17/32-24 | 1.83 | .94 | 1.10 | .314 |
| VS269AB-8-4 | 1/2 | 1/4 | 11/16-20 | 1.82 | .86 | .99 | .314 |
| VS269AB-8-6 | 1/2 | 3/8 | 11/16-20 | 1.88 | .93 | .99 | .408 |
| VS269AB-8-8 | 1/2 | 1/2 | 11/16-20 | 1.99 | 1.03 | 1.18 | .408 |
| VS269AB-10-6 | 5/8 | 3/8 | 13/16-18 | 2.09 | 1.00 | 1.05 | .408 |
| VS269AB-10-8 | 5/8 | 1/2 | 13/16-18 | 2.18 | 1.09 | 1.24 | .533 |
| VS269AB-12-8 | 3/4 | 1/2 | 1-18 | 2.33 | 1.19 | 1.32 | .533 |
| VS269AB-12-12 | 3/4 | 3/4 | 1-18 | 2.50 | 1.26 | 1.32 | .533 |

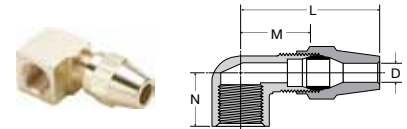

Female Elbow 270AB

REF. SAE 120203 BA

| PART NO. | TUBE SIZE | PIPE THREAD | STRAIGHT THREAD | L | M | N | FLOW DIA. D |
|------------|-----------|-------------|-----------------|------|------|------|-------------|
| 270AB-4-2 | 1/4 | 1/8 | 7/16-24 | 1.27 | .69 | .52 | .189 |
| 270AB-4-4 | 1/4 | 1/4 | 7/16-24 | 1.36 | .78 | .71 | .189 |
| 270AB-6-2 | 3/8 | 1/8 | 17/32-24 | 1.72 | .83 | .59 | .314 |
| 270AB-6-4 | 3/8 | 1/4 | 17/32-24 | 1.78 | .89 | .77 | .314 |
| 270AB-6-6 | 3/8 | 3/8 | 17/32-24 | 1.82 | .93 | .77 | .314 |
| 270AB-8-6 | 1/2 | 3/8 | 11/16-20 | 1.99 | 1.03 | .82 | .408 |
| 270AB-8-8 | 1/2 | 1/2 | 11/16-20 | 2.09 | 1.13 | 1.01 | .408 |
| 270AB-10-8 | 5/8 | 1/2 | 13/16-18 | 2.28 | 1.19 | 1.07 | .533 |

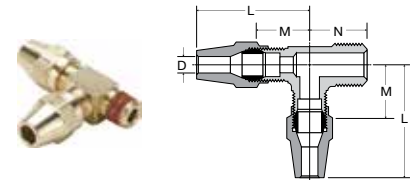

Male Run Tee VS271AB

REF. SAE 120424 BA

| PART NO. | TUBE SIZE | PIPE THREAD | STRAIGHT THREAD | L | M | N | FLOW DIA. D |
|--------------|-----------|-------------|-----------------|------|------|------|-------------|
| VS271AB-4-2 | 1/4 | 1/8 | 7/16-24 | 1.20 | .62 | .66 | .189 |
| VS271AB-4-4 | 1/4 | 1/4 | 7/16-24 | 1.26 | .68 | .87 | .189 |
| VS271AB-6-4 | 3/8 | 1/4 | 17/32-24 | 1.68 | .79 | .92 | .314 |
| VS271AB-6-6 | 3/8 | 3/8 | 17/32-24 | 1.73 | .84 | .91 | .314 |
| VS271AB-8-6 | 1/2 | 3/8 | 11/16-20 | 1.89 | .93 | .99 | .408 |
| VS271AB-8-8 | 1/2 | 1/2 | 11/16-20 | 1.99 | 1.03 | 1.18 | .408 |
| VS271AB-10-8 | 5/8 | 1/2 | 13/16-18 | 2.18 | 1.09 | 1.24 | .533 |

WARNING These products can expose you to chemicals including LEAD which is known to the state of California to cause cancer and birth defects or other reproductive harm. For more information go to www.P65Warnings.ca.gov.



- A
- B
- C
- D
- E
- F
- G
- H
- I
- J
- K
- L
- M
- N
- O

Click here for CADs, Product Specifications or to Configure Parts Online

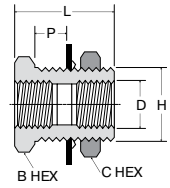
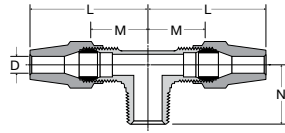

Male Branch Tee VS272AB

REF. SAE 120425 BA

| PART NO. | TUBE SIZE | PIPE THREAD | STRAIGHT THREAD | L | M | N | FLOW DIA. D |
|--------------|-----------|-------------|-----------------|------|------|------|-------------|
| VS272AB-4-2 | 1/4 | 1/8 | 7/16-24 | 1.20 | .62 | .66 | .189 |
| VS272AB-4-4 | 1/4 | 1/4 | 7/16-24 | 1.26 | .68 | .87 | .189 |
| VS272AB-6-2 | 3/8 | 1/8 | 17/32-24 | 1.61 | .72 | .75 | .189 |
| VS272AB-6-4 | 3/8 | 1/4 | 17/32-24 | 1.68 | .79 | .92 | .314 |
| VS272AB-6-6 | 3/8 | 3/8 | 17/32-24 | 1.73 | .84 | .91 | .314 |
| VS272AB-8-6 | 1/2 | 3/8 | 11/16-20 | 1.89 | .93 | .99 | .408 |
| VS272AB-8-8 | 1/2 | 1/2 | 11/16-20 | 1.99 | 1.03 | 1.18 | .408 |
| VS272AB-10-8 | 5/8 | 1/2 | 13/16-18 | 2.18 | 1.09 | 1.24 | .533 |

Anchor Coupling 207ACBH

| PART NO. | FEMALE PIPE THREAD | STRAIGHT THREAD | MAX .BKHD P | B HEX | C HEX | L | BKHD HOLE DIA. H | FLOW DIA. D |
|-------------|--------------------|-----------------|-------------|-------|-------|------|------------------|-------------|
| 207ACBH-2 | 1/8 | 5/8-18 | .89 | 7/8 | 15/16 | 1.50 | 5/8 | .339 |
| 207ACBHS-2 | 1/8 | 5/8-18 | .35 | 7/8 | 15/16 | .96 | 5/8 | .339 |
| 207ACBH-4 | 1/4 | 3/4-16 | .81 | 1 | 1-1/8 | 1.50 | 3/4 | .441 |
| 207ACBHS-4 | 1/4 | 3/4-16 | .26 | 1 | 1 | .94 | 3/4 | .441 |
| 207ACBH-6 | 3/8 | 1-14 | .62 | 1-1/8 | 1-1/4 | 1.31 | 1 | .571 |
| 207ACBH-8 | 1/2 | 1-1/8-14 | .75 | 1-1/4 | 1-3/8 | 1.50 | 1-1/8 | .703 |
| 207ACBH-12 | 3/4 | 1-5/16-12 | .65 | 1-1/2 | 1-1/2 | 1.50 | 1-5/16 | .906 |
| 207ACBH-16* | 1 | 1-5/8-14 | 1.00 | 2 | 2 | 1.68 | 1-5/8 | 1.140 |

*Lock Washer not Available

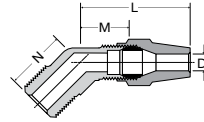

45° Elbow VS279AB

REF. SAE 120302 BA

| PART NO. | TUBE SIZE | PIPE THREAD | STRAIGHT THREAD | L | M | N | FLOW DIA. D |
|--------------|-----------|-------------|-----------------|------|------|------|-------------|
| VS279AB-4-2 | 1/4 | 1/8 | 7/16-24 | 1.07 | .49 | .63 | .189 |
| VS279AB-4-4 | 1/4 | 1/4 | 7/16-24 | 1.18 | .60 | .85 | .189 |
| VS279AB-6-2 | 3/8 | 1/8 | 17/32-24 | 1.60 | .71 | .68 | .189 |
| VS279AB-6-4 | 3/8 | 1/4 | 17/32-24 | 1.64 | .71 | .85 | .314 |
| VS279AB-6-6 | 3/8 | 3/8 | 17/32-24 | 1.64 | .75 | .94 | .314 |
| VS279AB-6-8 | 3/8 | 1/2 | 17/32-24 | 1.67 | .78 | 1.16 | .314 |
| VS279AB-8-6 | 1/2 | 3/8 | 11/16-20 | 1.80 | .84 | .94 | .408 |
| VS279AB-8-8 | 1/2 | 1/2 | 11/16-20 | 1.83 | .87 | 1.16 | .408 |
| VS279AB-10-6 | 5/8 | 3/8 | 13/16-18 | 2.03 | .94 | .98 | .408 |
| VS279AB-10-8 | 5/8 | 1/2 | 13/16-18 | 2.13 | 1.05 | 1.16 | .533 |
| VS279AB-12-8 | 3/4 | 1/2 | 1-18 | 2.34 | 1.10 | 1.18 | .533 |

WARNING These products can expose you to chemicals including LEAD which is known to the state of California to cause cancer and birth defects or other reproductive harm. For more information go to www.P65Warnings.ca.gov.

Air Brake Hose Ends Fittings



Parker's Air Brake Hose Fittings are field attachable fittings for use with Parker 271 air brake hose. Easy to assemble and disassemble, these fittings meet D.O.T. requirements when used with SAE J1402 air brake hose.

Product Features:

- Brass Body
- Meets D.O.T. FMVSS571.106 when used with SAE J1402 air brake hose

Markets:

- Heavy Duty Truck
- Trailer

Applications:

- Air Lines Frame to Axle

Specifications:

Pressure Range Up to 400 PSI (27.5 bar)

Temperature Range -65° to +250° F (-53.8° to +121.1° C)

Compatible Tubing:

- Parker 271 air brake hose
- SAE J1402 air brake hose

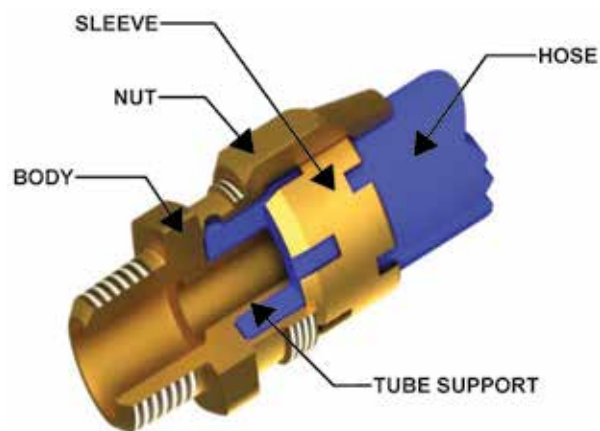

Assembly Instructions

1. Slide nut onto hose
2. Slide sleeve onto hose with tapered edge toward fitting body
3. Bottom hose into fitting
4. Tighten nut until it contacts body hex

Note: When reassembling fitting, body and nut should be inspected. Only reuse if parts are in proper condition. Sleeves should never be Reused.



WARNING These products can expose you to chemicals including NICKEL or LEAD, which are known to the state of California to cause cancer, and LEAD which is known to cause birth defects or other reproductive harm. For more information go to www.P65Warnings.ca.gov.



Click here for CADs, Product Specifications or to Configure Parts Online

- A
- B
- C
- D
- E
- F
- G
- H
- I
- J
- K
- L
- M
- N
- O

Spring 56RBSG

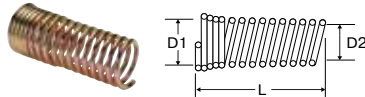

| PART NO. | HOSE SIZE | L | D1 | D2 |
|----------|-----------|------|------|-----|
| 56RBSG-6 | 3/8 | 2.75 | .84 | .78 |
| 56RBSG-8 | 1/2 | 3.00 | 1.03 | .91 |

Air Brake Hose Nut & Attached Spring 67RBSG

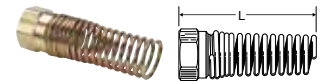

| PART NO. | L |
|----------|------|
| 67RBSG-6 | 3.50 |
| 67RBSG-8 | 3.75 |

Sleeve 60RB

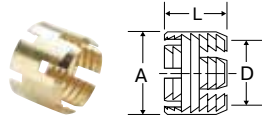

| PART NO. | HOSE SIZE | L | A | D |
|----------|-----------|-----|------|-----|
| 60RB-6 | 3/8 | .69 | .90 | .78 |
| 60RB-8 | 1/2 | .69 | 1.03 | .92 |

Male Connector 68RB

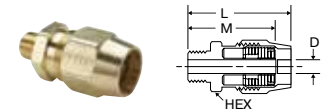

| PART NO. | HOSE SIZE | STRAIGHT THREAD | PIPE THREAD | HEX | L | M | D |
|----------|-----------|-----------------|-------------|-------|------|------|------|
| 68RB-6-4 | 3/8 | 31/32-20 | 1/4 | 31/32 | 2.24 | 1.91 | .281 |
| 68RB-6-6 | 3/8 | 31/32-20 | 3/8 | 31/32 | 2.24 | 1.91 | .281 |
| 68RB-6-8 | 3/8 | 31/32-20 | 1/2 | 31/32 | 2.38 | 2.06 | .281 |
| 68RB-8-6 | 1/2 | 1-3/32-20 | 3/8 | 1-1/8 | 2.24 | 1.91 | .390 |
| 68RB-8-8 | 1/2 | 1-3/32-20 | 1/2 | 1-1/8 | 2.29 | 2.07 | .390 |

Nut 61RB

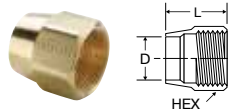

| PART NO. | HOSE SIZE | STRAIGHT THREAD | HEX | L | D |
|----------|-----------|-----------------|--------|------|-----|
| 61RB-6 | 3/8 | 31/32-20 | 1-1/16 | 1.12 | .80 |
| 61RB-8 | 1/2 | 1-3/32-20 | 1-1/4 | 1.12 | .93 |

Male Connector Body Only 68RB

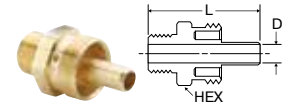

| PART NO. | HOSE SIZE | STRAIGHT THREAD | PIPE THREAD | HEX | L | D |
|-----------|-----------|-----------------|-------------|-------|------|------|
| 68RB-6-4B | 3/8 | 31/32-20 | 1/4 | 31/32 | 1.91 | .281 |
| 68RB-6-6B | 3/8 | 31/32-20 | 3/8 | 31/32 | 1.91 | .281 |
| 68RB-6-8B | 3/8 | 31/32-20 | 1/2 | 31/32 | 2.06 | .281 |
| 68RB-8-6B | 1/2 | 1-3/32-20 | 3/8 | 1-1/8 | 1.91 | .390 |
| 68RB-8-8B | 1/2 | 1-3/32-20 | 1/2 | 1-1/8 | 2.07 | .390 |

Spring Guard Nut 61RBSG

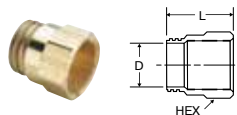

| PART NO. | HOSE SIZE | STRAIGHT THREAD | HEX | L | D |
|----------|-----------|-----------------|--------|------|-----|
| 61RBSG-6 | 3/8 | 31/32-20 | 1-1/16 | 1.22 | .80 |
| 61RBSG-8 | 1/2 | 1-3/32-20 | 1-1/4 | 1.19 | .92 |

Male Connector with Spring Guard 68RBSG

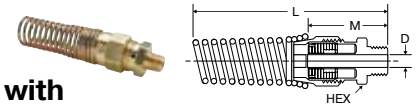

| PART NO. | HOSE SIZE | PIPE THREAD | HEX | L | M | D |
|------------|-----------|-------------|-------|-----|------|------|
| 68RBSG-6-4 | 3/8 | 1/4 | 31/32 | 4.8 | 1.91 | .281 |
| 68RBSG-6-6 | 3/8 | 3/8 | 31/32 | 4.8 | 1.91 | .281 |
| 68RBSG-6-8 | 3/8 | 1/2 | 31/32 | 4.9 | 2.06 | .281 |
| 68RBSG-8-6 | 1/2 | 3/8 | 1-1/8 | 5.0 | 1.91 | .390 |
| 68RBSG-8-8 | 1/2 | 1/2 | 1-1/8 | 5.2 | 2.07 | .390 |

Union 62RB

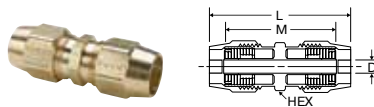

| PART NO. | HOSE SIZE | STRAIGHT THREAD | HEX | L | M | D |
|----------|-----------|-----------------|-------|------|------|------|
| 62RB-6 | 3/8 | 31/32-20 | 31/32 | 2.98 | 2.56 | .281 |
| 62RB-8 | 1/2 | 1-3/32-20 | 1-1/8 | 2.99 | 2.55 | .390 |

Adapter 76RB

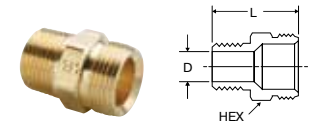

| PART NO. | PIPE THREAD | STRAIGHT THREAD | HEX | L | D |
|------------|-------------|-----------------|-----|------|------|
| 76RB-3/4-4 | 1/4 | 3/4-20 | 3/4 | 1.06 | .310 |
| 76RB-3/4-6 | 3/8 | 3/4-20 | 3/4 | 1.12 | .422 |
| 76RB-7/8-6 | 3/8 | 7/8-20 | 7/8 | 1.25 | .440 |
| 76RB-7/8-8 | 1/2 | 7/8-20 | 7/8 | 1.47 | .500 |

Female Swivel Connector 66RBSV

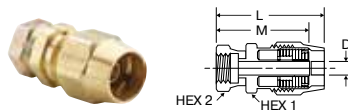

| PART NO. | HOSE SIZE | STRAIGHT THREAD | HEX1 | HEX2 | L | M | D |
|--------------|-----------|-----------------|-------|------|------|------|------|
| 66RBSV-6-3/4 | 3/8 | 3/4-20 | 31/32 | 7/8 | 2.30 | 2.09 | .281 |
| 66RBSV-8-7/8 | 1/2 | 7/8-20 | 1-1/8 | 1" | 2.36 | 2.14 | .390 |

WARNING These products can expose you to chemicals including NICKEL or LEAD, which are known to the state of California to cause cancer, and LEAD which is known to cause birth defects or other reproductive harm. For more information go to www.P65Warnings.ca.gov.



A
B
C
D
E
F
G
H
I
J
K
L
M
N
O



Vibra-Lok Fittings

Parker's Vibra-Lok Fittings provide a positive reliable seal under vibration conditions, mechanical shock or tube movement. The sleeve cushions the tubing, permitting the tubing to flex back and forth in the fitting. The seal design compensates for tube misalignment and tube surface defects.

Product Features:

- Brass Body
- Sleeves in Buna N and Fluorocarbon
- NPTF and SAE J1926 Straight Threads are Standard
- Excellent Vibration Resistance

Markets:

- Heavy Duty Truck
- Trailer
- Mobile

Applications:

- Oil, Fuel and Coolant Lines on engines

Specifications:

| | |
|--------------------------|--|
| Pressure Range | Dependent on condition and tube size, refer to pressure chart |
| Temperature Range | -15° to +450° F (-26.1° to +232.2° C) with Fluorocarbon Sleeve -30° to +275° F (-34.4° to +135° C) with Buna N Sleeve |

Compatible Tubing:

- Copper
- Aluminum
- Steel (Bundy)
- Stainless Steel
- Glass

Pressure Chart

| CONDITION | TUBE O.D. | TUBE NOT BELLED | TUBE BELLED OR FLARED |
|--------------------------------|-----------|-----------------|-----------------------|
| STATIC PRESSURE | 1/8" | 500 | 1000 |
| | 3/16" | 500 | 1000 |
| | 1/4" | 500 | 1000 |
| | 5/16" | 450 | 900 |
| | 3/8" | 350 | 700 |
| | 1/2" | 200 | 500 |
| MINOR SURGES AND/OR VIBRATIONS | 1/8" | 400 | 800 |
| | 3/16" | 400 | 800 |
| | 1/4" | 400 | 800 |
| | 5/16" | 325 | 700 |
| | 3/8" | 225 | 500 |
| | 1/2" | 150 | 375 |
| SEVERE VIBRATIONS OR SHOCK | 1/8" | 300 | 600 |
| | 3/16" | 300 | 600 |
| | 1/4" | 300 | 600 |
| | 5/16" | 225 | 500 |
| | 3/8" | 175 | 400 |
| | 1/2" | 100 | 250 |
| | 5/8" | | 100 |

In high pressure applications and sizes larger than 1/2" O.D., the tube end should be belled or flared.

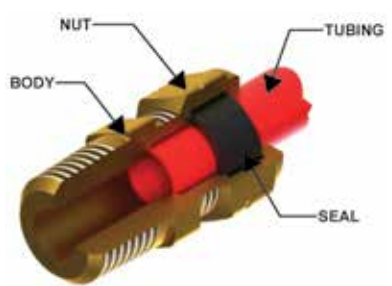

WARNING These products can expose you to chemicals including CARBON BLACK, or LEAD, which are known to the state of California to cause cancer, and LEAD which is known to cause birth defects or other reproductive harm. For more information go to www.P65Warnings.ca.gov.

[Click here for CADs, Product Specifications or to Configure Parts Online](#)

Assembly Instructions

1. Cut the tubing squarely removing burrs
2. Slip nut and sleeve over tube
3. Bottom tubing into fitting and tighten nut until stop is reached. The elastic sleeve ordinarily will extrude slightly around the tube at the end of the nut. This extrusion further aids in isolating the tube from the nut.



For Higher Pressure applications

4. Consult pressure chart to determine if tubing should be belled
5. Slip nut and sleeve over tube. The sleeve should be positioned near end of tubing just behind the surface to be belled
6. Bell tubing with standard 45° flaring tool or 90° punch. The size of bell should be approximately that shown.



Recommended Size of Bell

| TUBE O.D. | BELL DIA. C |
|-----------|-------------|
| 1/8 | .190-.160 |
| 3/16 | .255-.225 |
| 1/4 | .318-.288 |
| 5/16 | .381-.351 |
| 3/8 | .444-.414 |
| 1/2 | .569-.539 |
| 5/8 | .694-.664 |
| 3/4 | .819-.789 |
| 7/8 | .944-.914 |

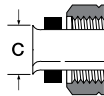

Tube Length Calculator

This table shows distance tube extends beyond face of Vibra-Lok fitting body on installation with bell on tubing and without bell on tubing.

| O.D. OF TUBE | A WITH BELL | B WITHOUT BELL |
|--------------|-------------|-------------------------|
| 1/8 | 3/16 | 3/16 |
| 3/16 | 3/16 | 7/32 |
| 1/4 | 3/16 | 1/4 |
| 5/16 | 3/16 | 1/4 |
| 3/8 | 3/16 | 1/4 |
| 1/2 | 3/16 | 11/32 |
| 5/8 | 3/16 | TUBING SHOULD BE BELLED |
| 3/4 | 3/16 | |
| 7/8 | 1/4 | |

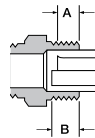

Sleeve 60VL



| PART NO. | TUBE SIZE | A | D | L |
|----------|-----------|-------|------|-----|
| 60VL-2 | 1/8 | .306 | .100 | .20 |
| 60VL-3 | 3/16 | .359 | .156 | .20 |
| 60VL-4 | 1/4 | .422 | .219 | .21 |
| 60VL-5 | 5/16 | .484 | .281 | .24 |
| 60VL-6 | 3/8 | .547 | .344 | .25 |
| 60VL-8 | 1/2 | .688 | .469 | .36 |
| 60VL-10 | 5/8 | .875 | .594 | .48 |
| 60VL-12 | 3/4 | 1.000 | .720 | .59 |

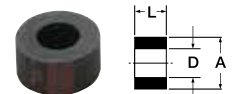

Sleeve (Fluorocarbon) 60VLV

| PART NO. | TUBE SIZE | A | D | L |
|----------|-----------|-------|------|-----|
| 60VLV-3 | 3/16 | .359 | .156 | .20 |
| 60VLV-4 | 1/4 | .422 | .219 | .21 |
| 60VLV-5 | 5/16 | .484 | .281 | .24 |
| 60VLV-6 | 3/8 | .547 | .344 | .25 |
| 60VLV-8 | 1/2 | .688 | .469 | .36 |
| 60VLV-10 | 5/8 | .875 | .594 | .48 |
| 60VLV-12 | 3/4 | 1.000 | .720 | .59 |

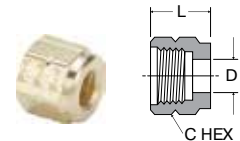

Nut 61VL

| PART NO. | TUBE SIZE | STRAIGHT THREAD | C HEX | D | L |
|----------|-----------|-----------------|-------|------|-----|
| 61VL-2 | 1/8 | 3/8-24 | 7/16 | .156 | .44 |
| 61VL-3 | 3/16 | 7/16-24 | 1/2 | .218 | .47 |
| 61VL-4 | 1/4 | 1/2-24 | 9/16 | .281 | .50 |
| 61VL-5 | 5/16 | 9/16-24 | 5/8 | .344 | .53 |
| 61VL-6 | 3/8 | 5/8-24 | 3/4 | .406 | .53 |
| 61VL-8 | 1/2 | 13/16-18 | 15/16 | .531 | .67 |
| 61VL-10 | 5/8 | 1-18 | 1-1/8 | .656 | .88 |
| 61VL-12 | 3/4 | 1-1/8-18 | 1-1/4 | .781 | .98 |

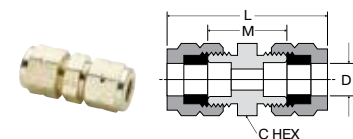

Union 62VL

| PART NO. | TUBE SIZE | C HEX | L | M | FLOW DIA. D |
|----------|-----------|-------|------|-----|-------------|
| 62VL-4 | 1/4 | 9/16 | 1.39 | .77 | .188 |
| 62VL-5 | 5/16 | 5/8 | 1.49 | .81 | .250 |
| 62VL-6 | 3/8 | 11/16 | 1.49 | .80 | .312 |
| 62VL-8 | 1/2 | 7/8 | 1.90 | .94 | .437 |

WARNING These products can expose you to chemicals including CARBON BLACK, or LEAD, which are known to the state of California to cause cancer, and LEAD which is known to cause birth defects or other reproductive harm. For more information go to www.P65Warnings.ca.gov.



[Click here for CADs, Product Specifications or to Configure Parts Online](#)

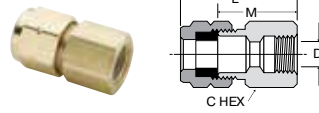

Female Connector 66VL

| PART NO. | TUBE SIZE | PIPE THREAD | C HEX | L | M | FLOW DIA. D |
|----------|-----------|-------------|-------|------|-----|-------------|
| 66VL-4-2 | 1/4 | 1/8 | 9/16 | 1.09 | .78 | .188 |
| 66VL-5-4 | 5/16 | 1/4 | 11/16 | 1.32 | .97 | .250 |

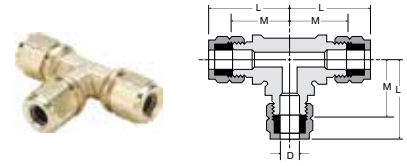

Union Tee 164VL

| PART NO. | TUBE SIZE | BODY HEX | L | M | FLOW DIA. D |
|----------|-----------|----------|------|------|-------------|
| 164VL-3 | 3/16 | 3/8 | .98 | .69 | .160 |
| 164VL-4 | 1/4 | 1/2 | 1.06 | .75 | .190 |
| 164VL-5 | 5/16 | 15/32 | 1.22 | .88 | .250 |
| 164VL-8 | 1/2 | 13/16 | 1.64 | 1.16 | .406 |

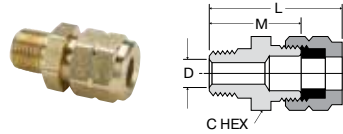

Male Connector 68VL

| PART NO. | TUBE SIZE | PIPE THREAD | C HEX | L | M | FLOW DIA. D |
|------------|-----------|-------------|--------|------|------|-------------|
| 68VL-2-2 | 1/8 | 1/8 | 7/16 | 1.12 | .81 | .093 |
| 68VL-3-2 | 3/16 | 1/8 | 1/2 | 1.10 | .81 | .125 |
| 68VL-4-2 | 1/4 | 1/8 | 9/16 | 1.15 | .84 | .188 |
| 68VL-4-4 | 1/4 | 1/4 | 9/16 | 1.34 | 1.03 | .188 |
| 68VL-5-4 | 5/16 | 1/4 | 5/8 | 1.41 | 1.06 | .250 |
| 68VL-6-2 | 3/8 | 1/8 | 11/16 | 1.22 | .87 | .235 |
| 68VL-6-4 | 3/8 | 1/4 | 11/16 | 1.41 | 1.06 | .312 |
| 68VL-6-6 | 3/8 | 3/8 | 11/16 | 1.41 | 1.06 | .312 |
| 68VL-8-6 | 1/2 | 3/8 | 7/8 | 1.64 | 1.16 | .406 |
| 68VL-8-8 | 1/2 | 1/2 | 7/8 | 1.64 | 1.35 | .406 |
| 68VL-10-8 | 5/8 | 1/2 | 1-1/16 | 2.10 | 1.44 | .560 |
| 68VL-12-8 | 3/4 | 1/2 | 1-3/16 | 2.26 | 1.50 | .530 |
| 68VL-12-12 | 3/4 | 3/4 | 1-3/16 | 2.26 | 1.50 | .688 |

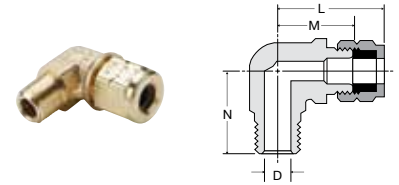

Male Elbow 169VL

| PART NO. | TUBE SIZE | PIPE THREAD | L | M | N | FLOW DIA. D |
|------------|-----------|-------------|------|------|------|-------------|
| 169VL-3-2 | 3/16 | 1/8 | .98 | .69 | .75 | .156 |
| 169VL-4-2 | 1/4 | 1/8 | 1.00 | .69 | .78 | .188 |
| 169VL-4-4 | 1/4 | 1/4 | 1.16 | .84 | 1.00 | .188 |
| 169VL-5-4 | 5/16 | 1/4 | 1.16 | .81 | 1.00 | .252 |
| 169VL-6-2 | 3/8 | 1/8 | 1.19 | .84 | .91 | .235 |
| 169VL-6-4 | 3/8 | 1/4 | 1.19 | .84 | 1.06 | .312 |
| 169VL-6-6 | 3/8 | 3/8 | 1.29 | .94 | 1.13 | .312 |
| 169VL-8-6 | 1/2 | 3/8 | 1.48 | 1.00 | 1.06 | .406 |
| 169VL-8-8 | 1/2 | 1/2 | 1.54 | 1.06 | 1.44 | .406 |
| 169VL-10-8 | 5/8 | 1/2 | 1.92 | 1.28 | 1.47 | .565 |

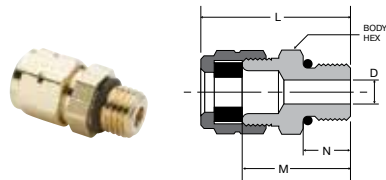

Male Connector 685VLV

| PART NO. | TUBE SIZE | STRAIGHT THREAD | BODY HEX | L | M | N | D |
|--------------|-----------|-----------------|----------|------|------|-----|-----|
| 685VLV-4-4 | 1/4 | 7/16-20 | 9/16 | 1.14 | .83 | .36 | .18 |
| 685VLV-5-4 | 5/16 | 7/16-20 | 5/8 | 1.18 | .83 | .36 | .18 |
| 685VLV-6-4 | 3/8 | 7/16-20 | 11/16 | 1.18 | .83 | .36 | .18 |
| 685VLV-6-6 | 3/8 | 9/16-18 | 11/16 | 1.25 | .90 | .39 | .30 |
| 685VLV-8-8 | 1/2 | 3/4-16 | 7/8 | 1.52 | 1.04 | .44 | .39 |
| 685VLV-10-10 | 5/8 | 7/8-14 | 1 1/16 | 1.84 | 1.20 | .50 | .50 |
| 685VLV-12-12 | 3/4 | 1 1/16-12 | 1 1/4 | 2.10 | 1.34 | .59 | .62 |

Note: Fluorocarbon seal & o-ring standard

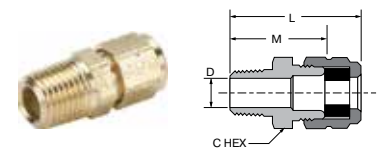

Straight Through Tank Fitting 682VL

| PART NO. | TUBE SIZE | PIPE THREAD | C HEX | L | M | FLOW DIA. D |
|-----------|-----------|-------------|-------|------|------|-------------|
| 682VL-4-2 | 1/4 | 1/8 | 9/16 | 1.15 | .84 | .265 |
| 682VL-4-4 | 1/4 | 1/4 | 9/16 | 1.34 | 1.03 | .265 |
| 682VL-5-4 | 5/16 | 1/4 | 5/8 | 1.41 | 1.06 | .328 |
| 682VL-6-6 | 3/8 | 3/8 | 11/16 | 1.41 | 1.06 | .406 |

WARNING These products can expose you to chemicals including CARBON BLACK, or LEAD, which are known to the state of California to cause cancer, and LEAD which is known to cause birth defects or other reproductive harm. For more information go to www.P65Warnings.ca.gov.



- A
- B
- C
- D
- E
- F
- G
- H
- I
- J
- K
- L
- M
- N
- O

Click here for CADs, Product Specifications or to Configure Parts Online

- A
- B
- C
- D
- E
- F
- G
- H
- I
- J
- K
- L
- M
- N
- O

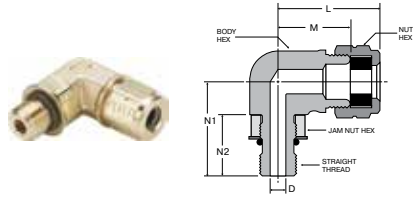

Male Elbow 1695VLV

| PART NO. | TUBE SIZE | STRAIGHT THREAD | NUT HEX | BODY HEX | JAM NUT HEX | L | M | N1 | N2 | D |
|---------------|-----------|-----------------|---------|----------|-------------|------|------|------|------|-----|
| 1695VLV-4-4 | 1/4 | 7/16-20 | 9/16 | 9/16 | 9/16 | 1.15 | .84 | 1.07 | .71 | .18 |
| 1695VLV-5-4 | 5/16 | 7/16-20 | 5/8 | 9/16 | 9/16 | 1.16 | .81 | 1.07 | .71 | .18 |
| 1695VLV-6-4 | 3/8 | 7/16-20 | 3/4 | 5/8 | 9/16 | 1.19 | .84 | 1.10 | .71 | .18 |
| 1695VLV-6-6 | 3/8 | 9/16-18 | 3/4 | 5/8 | 11/16 | 1.29 | .94 | 1.17 | .78 | .30 |
| 1695VLV-8-8 | 1/2 | 3/4-16 | 15/16 | 3/4 | 7/8 | 1.54 | 1.06 | 1.44 | .89 | .39 |
| 1695VLV-10-10 | 5/8 | 7/8-14 | 1 1/8 | 1.00 | 1.00 | 1.92 | 1.28 | 1.68 | 1.03 | .50 |
| 1695VLV-12-12 | 3/4 | 1 1/16-12 | 1 1/4 | 1.00 | 1 1/4 | 2.04 | 1.28 | 1.82 | 1.17 | .62 |

Note: Fluorocarbon seal & o-ring standard

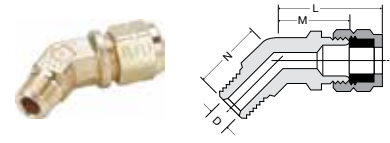

45° Elbow 179VL

| PART NO. | TUBE SIZE | PIPE THREAD | L | M | N | FLOW DIA. D |
|-----------|-----------|-------------|------|-----|-----|-------------|
| 179VL-4-2 | 1/4 | 1/8 | 1.06 | .75 | .69 | .188 |
| 179VL-6-4 | 3/8 | 1/4 | 1.07 | .72 | .84 | .315 |

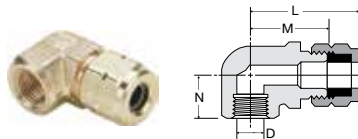

Female Elbow 170VL

| PART NO. | TUBE SIZE | PIPE THREAD | L | M | N | FLOW DIA. D |
|-----------|-----------|-------------|------|-----|-----|-------------|
| 170VL-4-2 | 1/4 | 1/8 | .96 | .65 | .50 | .188 |
| 170VL-5-4 | 5/16 | 1/4 | 1.16 | .81 | .70 | .250 |

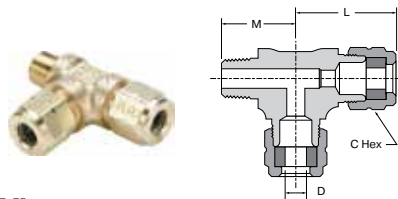

Male Run Tee 171VL

| PART NO. | TUBE SIZE | PIPE THREAD | C HEX | L | M | FLOW DIA. D |
|-----------|-----------|-------------|-------|------|------|-------------|
| 171VL-4-2 | 1/4 | 1/8 | 9/16 | 1.03 | .76 | .188 |
| 171VL-4-4 | 1/4 | 1/4 | 9/16 | 1.12 | 1.03 | .188 |

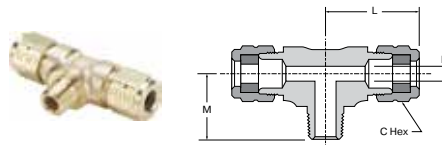

Male Branch Tee 172VL

| PART NO. | TUBE SIZE | PIPE THREAD | C HEX | L | M | FLOW DIA. D |
|-----------|-----------|-------------|-------|------|-----|-------------|
| 172VL-4-2 | 1/4 | 1/8 | 9/16 | 1.06 | .75 | .188 |

WARNING These products can expose you to chemicals including CARBON BLACK, or LEAD, which are known to the state of California to cause cancer, and LEAD which is known to cause birth defects or other reproductive harm. For more information go to www.P65Warnings.ca.gov.



Truck Valves & Lanyard Valve



Parker's Truck Valves have metal-to-metal seats with fine thread screwdown. Parker's Lanyard Valves' compact design is ideally suited for releasing condensate from air tanks.

Product Features:

Truck Valves

- Brass Body and Stem
- Flare, Hose, Tube and Pipe Connections
- Round and Pin Handles

Lanyard Valve

- Low Temperature Seal
- All Brass Body
- Manual Release

Markets:

- Heavy Duty Truck
- Trailer
- Mobile

Applications:

- Water
- Oil
- Coolant lines



Truck Valve Specifications:

Pressure Range Up to 150 PSI (10.3 bar)

Temperature Range -30° to +250° F (-34.4° to +121.1° C)

Lanyard Valve Specifications:

Pressure Range Up to 150 PSI (10.3 bar)

Temperature Range -40° to +200° F (-40° to +93.3° C)

Lanyard Valve Operating Instructions

A pulling action exerted on the cable cocks the stem, allowing condensate to pass through the valve. Releasing the cable resets the stem which returns the valve to its closed position.

WARNING These products can expose you to chemicals including LEAD which is known to the state of California to cause cancer and birth defects or other reproductive harm. For more information go to www.P65Warnings.ca.gov.



A

B

C

D

E

F

G

H

I

J

K

L

M

N

O

A

Truck Valve V404P

Hose to Male Pipe
Temperature Range: -30° to +250° F (-34.4° to +121.1° C)

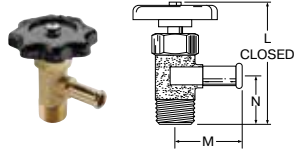

| PART NO. | HOSE I.D. | PIPE THREAD | FLOW | L | M | N |
|------------|-----------|-------------|------|------|------|------|
| V404P-6-6 | 3/8 | 3/8 | .281 | 2.35 | 1.36 | .94 |
| V404P-10-6 | 5/8 | 3/8 | .406 | 2.75 | 1.31 | 1.10 |

B

Truck Valve V409F

Flare to Male Pipe
Temperature Range: -30° to +250° F (-34.4° to +121.1° C)

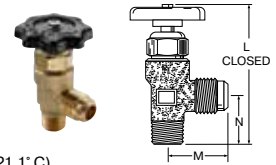

| PART NO. | TUBE SIZE | PIPE THREAD | FLOW | L | M | N |
|------------|-----------|-------------|------|------|------|------|
| V409F-8-6 | 1/2 | 3/8 | .406 | 3.07 | 1.31 | 1.00 |
| V409F-8-8 | 1/2 | 1/2 | .406 | 3.28 | 1.31 | 1.19 |
| V409F-10-8 | 5/8 | 1/2 | .500 | 3.47 | 1.50 | 1.25 |
| V409F-12-8 | 3/4 | 1/2 | .562 | 3.70 | 2.31 | 1.34 |

C

D

Truck Valve V404PH

Hose to Male Pipe with Pin Handle
Temperature Range: -30° to +250° F (-34.4° to +121.1° C)

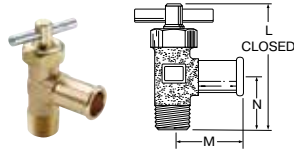

| PART NO. | HOSE I.D. | PIPE THREAD | FLOW | L | M | N |
|-------------|-----------|-------------|------|------|------|------|
| V404PH-10-6 | 5/8 | 3/8 | .406 | 2.47 | 1.31 | 1.10 |

E

F

Truck Valve V410NTA

Tube to Male Pipe
Temperature Range: -30° to +250° F (-34.4° to +121.1° C)

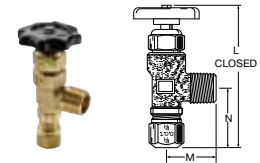

| F PART NO. | TUBE SIZE | PIPE THREAD | FLOW | L | M | N |
|-------------|-----------|-------------|------|------|------|------|
| V410NTA-8-8 | 1/2 | 1/2 | .328 | 3.58 | 1.38 | 1.31 |

G

Truck Valve SV404P

Hose to Male Pipe
Temperature Range: -30° to +250° F (-34.4° to +121.1° C)

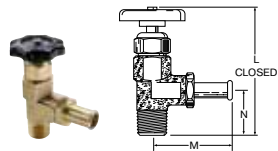

| PART NO. | HOSE I.D. | PIPE THREAD | FLOW | L | M | N |
|-------------|-----------|-------------|------|------|------|------|
| SV404P-10-8 | 5/8 | 1/2 | .468 | 3.71 | 2.31 | 1.34 |
| SV404P-12-6 | 3/4 | 3/8 | .438 | 3.73 | 2.31 | 1.34 |
| SV404P-12-8 | 3/4 | 1/2 | .562 | 3.73 | 2.31 | 1.34 |

H

I

Truck Valve V412F

Tube to Male Pipe
Temperature Range: -30° to +250° F (-34.4° to +121.1° C)

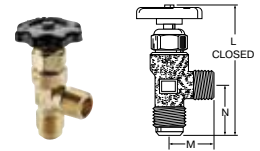

| PART NO. | TUBE SIZE | PIPE THREAD | FLOW | L | M | N |
|------------|-----------|-------------|------|------|------|------|
| V412F-10-8 | 5/8 | 1/2 | .500 | 3.60 | 1.38 | 1.31 |

J

Truck Valve V405P

Female Pipe to Male Pipe
Temperature Range: -30° to +250° F (-34.4° to +121.1° C)

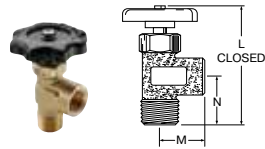

| PART NO. | FEMALE PIPE THREAD | MALE PIPE THREAD | FLOW | L | M | N |
|-----------|--------------------|------------------|------|------|------|------|
| V405P-6-6 | 3/8 | 3/8 | .406 | 2.72 | .91 | 1.19 |
| V405P-6-8 | 3/8 | 1/2 | .406 | 2.95 | .91 | 1.31 |
| V405P-8-8 | 1/2 | 1/2 | .562 | 3.15 | 1.17 | 1.34 |

L

M

Truck Valve V408NTA

Tube to Male Pipe
Temperature Range: -30° to +250° F (-34.4° to +121.1° C)

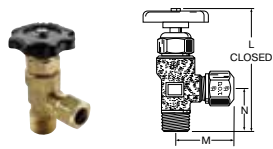

| PART NO. | TUBE SIZE | PIPE THREAD | FLOW | L | M | N |
|-------------|-----------|-------------|------|------|------|------|
| V408NTA-8-8 | 1/2 | 1/2 | .328 | 3.28 | 1.15 | 1.19 |

N

O

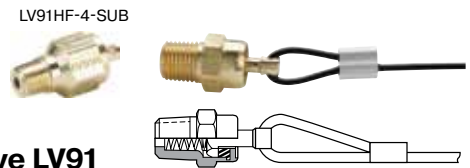

Lanyard Valve LV91

Temperature Range: -40° to +200° F (-40° to +93.3° C)

| PART NO. | PIPE THREAD | CABLE LENGTH INCHES |
|--------------|-------------|---------------------|
| LV91-4-036 | 1/4 | 36 |
| LV91-4-048 | 1/4 | 48 |
| LV91-4-060 | 1/4 | 60 |
| LV91HF-4-SUB | 1/4 | -- |

WARNING These products can expose you to chemicals including LEAD which is known to the state of California to cause cancer and birth defects or other reproductive harm. For more information go to www.P65Warnings.ca.gov.



Industrial Compression Style Fittings

Compression Fittings

Compress-Align[®] Fittings

Brass Metric Compression

Poly-Tite Fittings

Hi-Duty Flareless Tube Fittings





■ Compression Fittings

60C
Sleeve
p. G8



60PT
Plastic Sleeve
p. G8



61C
Nut
p. G8



61CL
Long Nut
p. G8



62C
Union
p. G8



62CBH
Bulkhead Union
p. G9



63PT
Tube Support
p. G9, G13



66C
Female Connector
NPT
p. G9



68C
Male Connector
NPTF
p. G9



164C-264C
Union Tee
p. G10



165C-265C
Union Elbow
p. G10



169C-269C
Male Elbow
NPTF
p. G10



170C-270C
Female Elbow
NPT
p. G11



171C
Male Run Tee
NPTF
p. G11



172C
Male Branch Tee
NPTF
p. G11



176C
Adaptor
NPTF
p. G11



177C
Female Branch Tee
NPT
p. G11



179C
45° Male Elbow
NPTF
p. G11



639C
Seal Plug
p. G11



682C
Tank Fitting
NPTF
p. G11



■ Compress-Align® Fittings

59CA
Plug
p. G13



61CA
Nut/Sleeve
p. G13



62CA
Union
p. G13



62CABH
Bulkhead Union
p. G13



62PCA
Union
p. G13



62PCABH
Bulkhead Union
p. G13



63PT
Tube Support
p. G9, G14



66CA
Female Connector
NPT
p. G14



68CA
Male Connector
NPTF
p. G14



164CA-264CA
Union Tee
p. G15



165CA-265CA
Union Elbow
p. G15



169CA-269CA
Male Elbow
NPTF
p. G15



170CA-270CA
Female Elbow
NPT
p. G16



171CA
Male Run Tee
NPTF
p. G16



172CA
Male Branch Tee
NPTF
p. G16



176CA
Adaptor
NPTF
p. G16



177CA
Female Branch Tee
NPT
p. G16



179CA
45° Male Elbow
NPTF
p. G16



639CA
Seal Plug
p. G16



682CA
Tank Fitting
NPTF
p. G16



⚠ WARNING These products can expose you to chemicals including NICKEL or LEAD, which are known to the state of California to cause cancer, and LEAD which is known to cause birth defects or other reproductive harm. For more information go to www.P65Warnings.ca.gov.

Brass Metric Compression Fittings

0105
Male Connector
NPT, BSPT
p. G18



0101
Male Elbow
BSPP, Straight
p. G18, G19



0114
Female Connector
BSPP
p. G20



0109
Male Elbow
NPT, BSPT
p. G20, G21



0199
Male Elbow
BSPP
p. G21



0108
Male Branch Tee
BSPT
p. G21



0103
Male Run Tee
BSPT
p. G22



0118
Single Banjo
p. G22, G23



0119
Double Banjo
p. G22, G23



0106
Union
p. G23



0116
Bulkhead Union
p. G23



0102
Union Elbow
p. G24



0104
Union Tee
p. G24



0107
Union Cross
p. G24



0142
Union Y
p. G24



0124
Metric Sleeve
p. G25



0111
Metric Sleeve
p. G25



0110
Metric Nut
p. G25



0110 60
Metric Nut
p. G25



0110 70
Metric Nut Sleeve
p. G27



0125
Metric End Plug
p. G27



0220
Metric Male Plug
p. G27



0168
Reducer
BSPP
p. G27



0127
Metric Tube
Support
p. G27



Poly-Tite Fittings

56PSG
Spring guard
p. G29



59P
Plug
p. G29



60P
Plastic Sleeve
p. G29



60PB
Brass Sleeve
p. G29



61P
Nut/Plastic Sleeve
p. G29



61PB
Nut/Brass Sleeve
p. G29



61PN
Nut Only
p. G29



61PSGN
Spring Guard Nut
p. G29



62P
Union
p. G29, G30



62PBH
Bulkhead Union
p. G30



62PCA
Union
p. G30



62PCABH
Bulkhead Union
p. G30



62PTBH
Bulkhead Union
p. G30



66P
Female Connector
NPT
p. G30



68P
Male Connector
NPTF
p. G31



97P
Tube Reducer
p. G31



391P
Coupler Body
p. G31



391PSS
Coupler Body
p. G31



392P
Bulkhead Body
p. G31



392PSS
Bulkhead Body
p. G31



393P
Through Insert
p. G31



WARNING These products can expose you to chemicals including NICKEL or LEAD, which are known to the state of California to cause cancer, and LEAD which is known to cause birth defects or other reproductive harm. For more information go to www.P65Warnings.ca.gov.



A
B
C
D
E
F
G
H
I
J
K
L
M
N
O

393PSS
Through Insert
p. G31



393PD
Shutoff Insert
p. G32



393PDSS
Shutoff Insert
p. G32



394P
Single Shutoff
p. G32



394PSS
Single Shutoff
p. G32



394PD
Double Shutoff
p. G32



394PDSS
Double Shutoff
p. G32



398P
Single Shutoff
p. G32



398PSS
Single Shutoff
p. G32



398PD
Double Shutoff
p. G33



398PDSS
Double Shutoff
p. G33



164P
Union Tee
p. G33



169P-269P
Male Elbow
NPTF
p. G33



169LP
Long Elbow
NPTF
p. G33



169PS
Male Elbow Swivel
NPTF
p. G33



170P
Female Elbow
NPT
p. G34



171P
Male Run Tee
NPTF
p. G34



172P
Male Branch Tee
NPTF
p. G34



177P
Female Branch Tee
NPT
p. G34



NV311P
Needle Valve
NPTF
p. G34



NV312P
Needle Valve
NPTF
p. G34



Hi-Duty Flareless Tube Fittings

62HDBH
Bulkhead Union
p. G36



61HD
Nut
p. G36



62HD
Union
p. G36



62HD
Reducing Union
p. G36



164HD
Union Tee
p. G36



165HD
Union Elbow
p. G36



66HD
Female Connector
NPT
p. G36



68HD
Male Connector
NPTF
p. G37



169HD
Male Elbow
NPTF
p. G37



170HD
Female Elbow
NPT
p. G37



171HD
Male Run Tee
NPTF
p. G37



172HD
Male Branch Tee
NPTF
p. G37



179HD
45° Male Elbow
NPTF
p. G37



177HD
Female Branch Tee
NPT
p. G38



59HD
Plug
p. G38



WARNING These products can expose you to chemicals including NICKEL or LEAD, which are known to the state of California to cause cancer, and LEAD which is known to cause birth defects or other reproductive harm. For more information go to www.P65Warnings.ca.gov.





Compression Fittings

Parker's Compression Fittings provide users with an economical choice with numerous connection options for a wide variety of tube materials without the need for flaring, soldering or other tube preparation necessary to assemble.

Product Features:

- Meets functional requirements of SAE J-512
- UL Listed for flammable liquid
- Brass or acetal sleeve available
- No tube preparation
- Forged and extruded shapes

Markets:

- Industrial
- Packaging
- Pneumatic
- Printing

Applications:

- Air lines
- Lubrication Lines
- Cooling lines
- Industry
- Machinery
- Compressors
- Fluid transfer

Compatible Tubing:

- Copper
- Aluminum
- Thermoplastic tubing

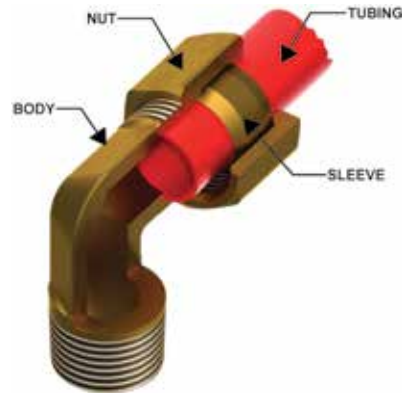

Assembly Instructions

1. Slide nut then sleeve onto tubing. The thread end of the nut must face out.
2. Insert tube and bottom on the fitting shoulder
3. Assemble nut to body and tighten "hand tight". Then wrench tighten the number of turns indicated in the table.



Specifications:

Temperature Range: -65° to +250° F (- 53.8° to +121.1° C)

Pressure Range:

| TUBE SIZE | PSI | bar | TUBE SIZE | PSI | bar |
|-----------|------|-------|-----------|-----|------|
| 1/8 | 2800 | 193.0 | 1/2 | 750 | 51.7 |
| 3/16 | 1900 | 131.0 | 5/8 | 650 | 44.8 |
| 1/4 | 1400 | 96.5 | 3/4 | 550 | 37.9 |
| 5/16 | 1200 | 82.7 | 7/8 | 450 | 24.1 |
| 3/8 | 1000 | 68.9 | | | |

Note: Pressures listed in above table are with brass sleeve and copper tubing

| FITTING SIZE | TUBE SIZE | TURNS REQUIRED TO SEAL FROM HAND-TIGHT | |
|--------------|-----------|--|--------------------------------|
| | | 60C WITH SOFT METAL TUBING | 60PT WITH THERMOPLASTIC TUBING |
| 2 | 1/8 | 1-1/4 | -- |
| 3 | 3/16 | 1-1/4 | -- |
| 4 | 1/4 | 1-1/4 | 2 |
| 5 | 5/16 | 1-1/4 | 2 |
| 6 | 3/8 | 2-1/4 | 2 |
| 8 | 1/2 | 2-1/4 | 2 |
| 10 | 5/8 | 2-1/4 | 2 |
| 12 | 3/4 | 2-1/4 | 2 |
| 14 | 7/8 | 2-1/4 | -- |

WARNING These products can expose you to chemicals including LEAD which is known to the state of California to cause cancer and birth defects or other reproductive harm. For more information go to www.P65Warnings.ca.gov.



[Click here for CADs, Product Specifications or to Configure Parts Online](#)

- A
- B
- C
- D
- E
- F
- G
- H
- I
- J
- K
- L
- M
- N
- O

Sleeve 60C

REF. SAE 060115

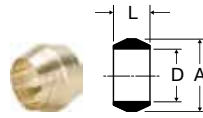

| PART NO. | TUBE SIZE | A | D | L |
|----------|-----------|-------|------|-----|
| 60C-2 | 1/8 | .187 | .130 | .19 |
| 60C-3 | 3/16 | .266 | .192 | .22 |
| 60C-4 | 1/4 | .344 | .255 | .25 |
| 60C-5 | 5/16 | .406 | .318 | .25 |
| 60C-6 | 3/8 | .469 | .382 | .25 |
| 60C-7 | 7/16 | .531 | .444 | .31 |
| 60C-8 | 1/2 | .594 | .507 | .38 |
| 60C-10 | 5/8 | .719 | .632 | .38 |
| 60C-12 | 3/4 | .875 | .758 | .44 |
| 60C-14 | 7/8 | 1.000 | .883 | .41 |

Acetal Sleeve 60PT

| PART NO. | PLASTIC TUBE WALL | TUBE WALL | A | D | L |
|----------|-------------------|-----------|------|------|-----|
| 60PT-4 | 1/4 | .040 | .375 | .254 | .19 |
| 60PT-5 | 5/16 | .062 | .438 | .317 | .19 |
| 60PT-6 | 3/8 | .062 | .500 | .379 | .19 |
| 60PT-8 | 1/2 | .062 | .631 | .507 | .25 |
| 60PT-10 | 5/8 | .062 | .747 | .632 | .22 |

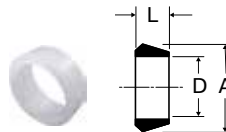

Nut 61C

REF. SAE 060110

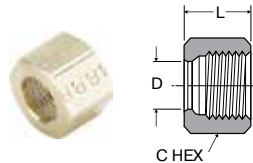

| PART NO. | TUBE SIZE | STRAIGHT THREAD | C HEX | D | L |
|----------|-----------|-----------------|--------|------|-----|
| 61C-2 | 1/8 | 5/16-24 | 3/8 | .130 | .38 |
| 61C-3 | 3/16 | 3/8-24 | 7/16 | .192 | .41 |
| 61C-4 | 1/4 | 7/16-24 | 1/2 | .255 | .44 |
| 61C-5 | 5/16 | 1/2-24 | 9/16 | .318 | .44 |
| 61C-6 | 3/8 | 9/16-24 | 5/8 | .382 | .47 |
| 61C-7 | 7/16 | 5/8-24 | 11/16 | .444 | .50 |
| 61C-8 | 1/2 | 11/16-20 | 13/16 | .507 | .62 |
| 61C-10 | 5/8 | 13/16-18 | 15/16 | .632 | .62 |
| 61C-12 | 3/4 | 1-18 | 1-3/16 | .758 | .69 |
| 61C-14 | 7/8 | 1-1/8-18 | 1-1/4 | .890 | .62 |

Long Nut 61CL

REF. SAE 060111

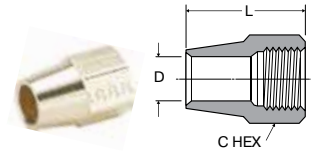

| PART NO. | TUBE SIZE | STRAIGHT THREAD | C HEX | D | L |
|----------|-----------|-----------------|--------|------|------|
| 61CL-4 | 1/4 | 7/16-24 | 1/2 | .255 | .75 |
| 61CL-5 | 5/16 | 1/2-24 | 9/16 | .318 | .84 |
| 61CL-6 | 3/8 | 9/16-24 | 5/8 | .382 | .97 |
| 61CL-8 | 1/2 | 11/16-20 | 13/16 | .507 | 1.06 |
| 61CL-10 | 5/8 | 13/16-18 | 15/16 | .632 | 1.19 |
| 61CL-12 | 3/4 | 1-18 | 1-3/16 | .758 | 1.38 |

Union 62C

REF. SAE 060101 BA

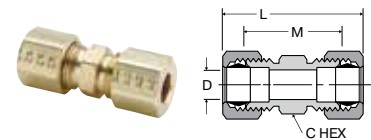

| PART NO. | TUBE SIZE | STRAIGHT THREAD | C HEX | L | M | FLOW DIA. D |
|----------|-----------|-----------------|-------|------|------|-------------|
| 62C-2 | 1/8 | 5/16-24 | 5/16 | 1.05 | .64 | .094 |
| 62C-3 | 3/16 | 3/8-24 | 3/8 | 1.21 | .72 | .125 |
| 62C-4 | 1/4 | 7/16-24 | 7/16 | 1.33 | .79 | .188 |
| 62C-5 | 5/16 | 1/2-24 | 1/2 | 1.39 | .85 | .250 |
| 62C-6 | 3/8 | 9/16-24 | 9/16 | 1.52 | .97 | .312 |
| 62C-7 | 7/16 | 5/8-24 | 5/8 | 1.70 | 1.02 | .312 |
| 62C-8 | 1/2 | 11/16-20 | 11/16 | 1.90 | 1.08 | .406 |
| 62C-10 | 5/8 | 13/16-18 | 13/16 | 2.06 | 1.23 | .500 |
| 62C-12 | 3/4 | 1-18 | 1 | 2.37 | 1.41 | .562 |
| 62C-14 | 7/8 | 1-1/8-18 | 1-1/8 | 2.07 | 1.19 | .766 |

Union Reducers 62C

REF. SAE 060101 BA

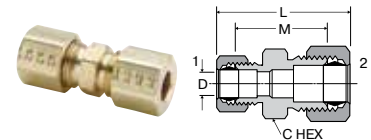

| PART NO. | 1 TUBE SIZE | 2 TUBE SIZE | 1 STRAIGHT THREAD | 2 STRAIGHT THREAD | C HEX | L | M | FLOW DIA. D |
|----------|-------------|-------------|-------------------|-------------------|-------|------|------|-------------|
| 62C-4-3 | 3/16 | 1/4 | 3/8-24 | 7/16-24 | 7/16 | 1.29 | .78 | .125 |
| 62C-6-4 | 1/4 | 3/8 | 7/16-24 | 9/16-24 | 9/16 | 1.46 | .91 | .188 |
| 62C-8-6 | 3/8 | 1/2 | 9/16-24 | 11/16-20 | 11/16 | 1.71 | 1.03 | .312 |
| 62C-10-6 | 3/8 | 5/8 | 9/16-24 | 13/16-18 | 13/16 | 1.82 | 1.13 | .312 |

WARNING These products can expose you to chemicals including LEAD which is known to the state of California to cause cancer and birth defects or other reproductive harm. For more information go to www.P65Warnings.ca.gov.

[Click here for CADs, Product Specifications or to Configure Parts Online](#)

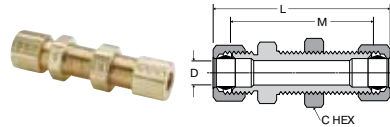

Bulkhead Union 62CBH

| PART NO. | TUBE SIZE | STRAIGHT THREAD | C HEX | L | M | BULKHEAD HOLE DIA. | FLOW DIA. D |
|----------|-----------|-----------------|-------|------|------|--------------------|-------------|
| 62CBH-4 | 1/4 | 7/16-24 | 9/16 | 2.29 | 1.75 | 7/16 | .188 |
| 62CBH-6 | 3/8 | 9/16-24 | 11/16 | 2.42 | 1.88 | 9/16 | .312 |

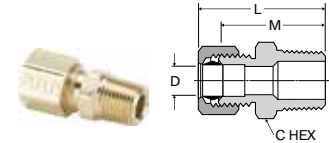

Male Connector 68C

REF. SAE 060102 BA

| PART NO. | TUBE SIZE | PIPE THREAD | STRAIGHT THREAD | C HEX | L | M | FLOW DIA. D |
|-----------|-----------|-------------|-----------------|--------|------|------|-------------|
| 68C-2-1 | 1/8 | 1/16 | 5/16-24 | 3/8 | .99 | .78 | .095 |
| 68C-2-2 | 1/8 | 1/8 | 5/16-24 | 7/16 | .97 | .77 | .094 |
| 68C-3-1 | 3/16 | 1/16 | 3/8-24 | 3/8 | 1.08 | .84 | .125 |
| 68C-3-2 | 3/16 | 1/8 | 3/8-24 | 7/16 | 1.08 | .84 | .125 |
| 68C-3-4 | 3/16 | 1/4 | 3/8-24 | 9/16 | 1.27 | 1.03 | .125 |
| 68C-4-2 | 1/4 | 1/8 | 7/16-24 | 7/16 | 1.10 | .86 | .188 |
| 68C-4-4 | 1/4 | 1/4 | 7/16-24 | 9/16 | 1.30 | 1.06 | .188 |
| 68C-4-6 | 1/4 | 3/8 | 7/16-24 | 11/16 | 1.27 | 1.03 | .188 |
| 68C-4-8 | 1/4 | 1/2 | 7/16-24 | 7/8 | 1.55 | 1.31 | .188 |
| 68C-5-2 | 5/16 | 1/8 | 1/2-24 | 1/2 | 1.15 | .89 | .234 |
| 68C-5-4 | 5/16 | 1/4 | 1/2-24 | 9/16 | 1.33 | 1.07 | .250 |
| 68C-6-2 | 3/8 | 1/8 | 9/16-24 | 9/16 | 1.25 | .97 | .250 |
| 68C-6-4 | 3/8 | 1/4 | 9/16-24 | 9/16 | 1.42 | 1.14 | .312 |
| 68C-6-6 | 3/8 | 3/8 | 9/16-24 | 11/16 | 1.44 | 1.16 | .312 |
| 68C-6-8 | 3/8 | 1/2 | 9/16-24 | 7/8 | 1.53 | 1.25 | .312 |
| 68C-7-4 | 7/16 | 1/4 | 5/8-24 | 5/8 | 1.50 | 1.17 | .312 |
| 68C-8-4 | 1/2 | 1/4 | 11/16-20 | 11/16 | 1.60 | 1.20 | .312 |
| 68C-8-6 | 1/2 | 3/8 | 11/16-20 | 11/16 | 1.60 | 1.20 | .406 |
| 68C-8-8 | 1/2 | 1/2 | 11/16-20 | 7/8 | 1.71 | 1.31 | .406 |
| 68C-10-6 | 5/8 | 3/8 | 13/16-18 | 13/16 | 1.73 | 1.31 | .406 |
| 68C-10-8 | 5/8 | 1/2 | 13/16-18 | 7/8 | 1.90 | 1.48 | .500 |
| 68C-10-12 | 5/8 | 3/4 | 13/16-18 | 1-1/16 | 1.98 | 1.56 | .500 |
| 68C-12-8 | 3/4 | 1/2 | 1-18 | 1 | 2.05 | 1.60 | .562 |
| 68C-12-12 | 3/4 | 3/4 | 1-18 | 1-1/16 | 2.08 | 1.63 | .656 |
| 68C-14-12 | 7/8 | 3/4 | 1-1/8-18 | 1-1/8 | 1.76 | 1.41 | .750 |

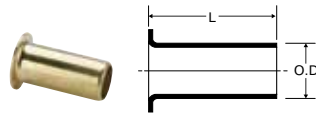

Brass Insert 63PT

| PART NO. | TUBE O.D. | TUBE WALL | L | O.D. |
|------------|-----------|-----------|-----|------|
| 63PT-2-16 | 1/8 | .016 | .46 | .080 |
| 63PT-2-23 | 1/8 | .023 | .45 | .073 |
| 63PT-3-25 | 3/16 | .025 | .45 | .135 |
| 63PT-3-40 | 3/16 | .040 | .52 | .095 |
| 63NTA-4* | 1/4 | | .53 | .163 |
| 63PT-4-62 | 1/4 | .062 | .33 | .110 |
| 63PT-5-40 | 5/16 | .040 | .50 | .232 |
| 63PT-5-62 | 5/16 | .062 | .53 | .187 |
| 63NTA-6* | 3/8 | | .64 | .245 |
| 63NTA-8* | 1/2 | | .81 | .370 |
| 63PT-10-62 | 5/8 | .062 | .72 | .483 |

* Denotes 304 stainless steel

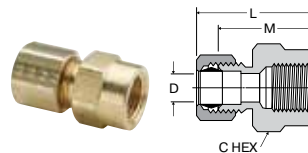

Female Connector 66C

REF. SAE 060103 BA

| PART NO. | TUBE SIZE | PIPE THREAD | STRAIGHT THREAD | C HEX | L | M | FLOW DIA. D |
|----------|-----------|-------------|-----------------|-------|------|------|-------------|
| 66C-2-2 | 1/8 | 1/8 | 5/16-24 | 9/16 | .95 | .75 | .094 |
| 66C-3-2 | 3/16 | 1/8 | 3/8-24 | 9/16 | 1.02 | .78 | .125 |
| 66C-3-4 | 3/16 | 1/4 | 3/8-24 | 11/16 | 1.20 | .96 | .125 |
| 66C-4-2 | 1/4 | 1/8 | 7/16-24 | 9/16 | 1.02 | .78 | .188 |
| 66C-4-4 | 1/4 | 1/4 | 7/16-24 | 11/16 | 1.24 | 1.00 | .188 |
| 66C-5-2 | 5/16 | 1/8 | 1/2-24 | 9/16 | 1.07 | .81 | .250 |
| 66C-5-4 | 5/16 | 1/4 | 1/2-24 | 11/16 | 1.29 | 1.03 | .250 |
| 66C-6-2 | 3/8 | 1/8 | 9/16-24 | 9/16 | 1.06 | .78 | .312 |
| 66C-6-4 | 3/8 | 1/4 | 9/16-24 | 11/16 | 1.34 | 1.06 | .312 |
| 66C-6-6 | 3/8 | 3/8 | 9/16-24 | 13/16 | 1.34 | 1.06 | .312 |
| 66C-6-8 | 3/8 | 1/2 | 9/16-24 | 1 | 1.54 | 1.27 | .312 |
| 66C-7-6 | 7/16 | 3/8 | 5/8-24 | 13/16 | 1.43 | 1.09 | .312 |
| 66C-8-4 | 1/2 | 1/4 | 11/16-20 | 11/16 | 1.49 | 1.09 | .406 |
| 66C-8-6 | 1/2 | 3/8 | 11/16-20 | 13/16 | 1.52 | 1.12 | .406 |
| 66C-8-8 | 1/2 | 1/2 | 11/16-20 | 1 | 1.71 | 1.31 | .406 |
| 66C-10-8 | 5/8 | 1/2 | 13/16-18 | 1 | 1.80 | 1.38 | .500 |

WARNING These products can expose you to chemicals including LEAD which is known to the state of California to cause cancer and birth defects or other reproductive harm. For more information go to www.P65Warnings.ca.gov.



Click here for CADs, Product Specifications or to Configure Parts Online

- A
- B
- C
- D
- E
- F
- G
- H
- I
- J
- K
- L
- M
- N
- O

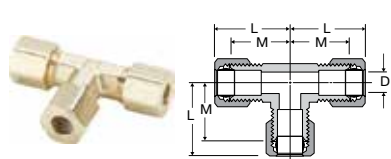

**Union Tee
164C-264C**

REF. SAE 060401 BA

| PART NO. | TUBE SIZE | STRAIGHT THREAD | L | M | FLOW DIA. D |
|----------|-----------|-----------------|------|------|-------------|
| 164C-2 | 1/8 | 5/16-24 | .82 | .61 | .094 |
| 264C-3 | 3/16 | 3/8-24 | .84 | .60 | .125 |
| 164C-4 | 1/4 | 7/16-24 | .86 | .63 | .188 |
| 264C-4 | 1/4 | 7/16-24 | .84 | .60 | .188 |
| 164C-5 | 5/16 | 1/2-24 | .98 | .71 | .250 |
| 164C-6 | 3/8 | 9/16-24 | 1.03 | .74 | .312 |
| 164C-8 | 1/2 | 11/16-20 | 1.34 | .93 | .406 |
| 164C-10 | 5/8 | 13/16-18 | 1.54 | 1.08 | .500 |
| 164C-12 | 3/4 | 1.00-18 | 1.65 | 1.17 | .563 |

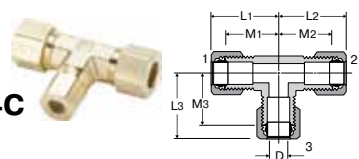

**Union Tee 164C-264C
Combination Sizes**

REF. SAE 060401 BA

| PART NO. | 1 TUBE SIZE | 2 TUBE SIZE | 3 TUBE SIZE | L1 | L2 | L3 | M1 | M2 | M3 | FLOW DIA. D |
|------------|-------------|-------------|-------------|------|------|------|-----|-----|-----|-------------|
| 164C-6-4-4 | 3/8 | 1/4 | 1/4 | 1.03 | .96 | .96 | .75 | .72 | .72 | .188 |
| 164C-6-6-4 | 3/8 | 3/8 | 1/4 | 1.03 | .96 | .96 | .75 | .75 | .72 | .188 |
| 164C-8-8-6 | 1/2 | 1/2 | 3/8 | 1.34 | 1.16 | 1.16 | .94 | .94 | .88 | .312 |

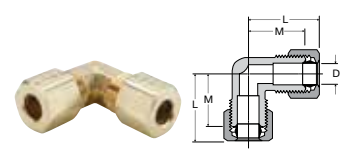

**Union Elbow
165C-265C**

REF. SAE 060201 BA

| PART NO. | TUBE SIZE | STRAIGHT THREAD | L | M | FLOW DIA. D |
|----------|-----------|-----------------|------|------|-------------|
| 165C-2 | 1/8 | 5/16-24 | .82 | .61 | .094 |
| 165C-3 | 3/16 | 3/8-24 | .87 | .61 | .125 |
| 165C-4 | 1/4 | 7/16-24 | .88 | .61 | .188 |
| 265C-4 | 1/4 | 7/16-24 | .84 | .60 | .188 |
| 165C-5 | 5/16 | 1/2-24 | .95 | .71 | .250 |
| 165C-6 | 3/8 | 9/16-24 | 1.03 | .74 | .312 |
| 165C-7 | 7/16 | 5/3-24 | 1.16 | .82 | .312 |
| 165C-8 | 1/2 | 11/16-20 | 1.34 | .93 | .406 |
| 165C-10 | 5/8 | 13/16-18 | 1.48 | 1.05 | .500 |
| 165C-12 | 3/4 | 1-18 | 1.65 | 1.17 | .563 |

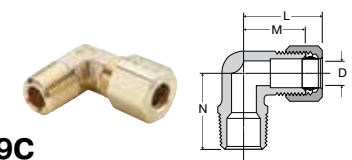

Male Elbow 169C-269C

REF. SAE 060202 BA

| PART NO. | TUBE SIZE | PIPE THREAD | STRAIGHT THREAD | L | M | N | FLOW DIA. D |
|------------|-----------|-------------|-----------------|------|------|------|-------------|
| 169C-2-1 | 1/8 | 1/16 | 5/16-24 | .81 | .60 | .67 | .095 |
| 269C-2-2 | 1/8 | 1/8 | 5/16-24 | .80 | .60 | .67 | .094 |
| 169C-3-1 | 3/16 | 1/16 | 3/8-24 | .85 | .61 | .67 | .126 |
| 169C-3-2 | 3/16 | 1/8 | 3/8-24 | .84 | .61 | .69 | .125 |
| 269C-3-2 | 3/16 | 1/8 | 3/8-24 | .84 | .60 | .67 | .125 |
| 169C-3-4 | 3/16 | 1/4 | 3/8-24 | .86 | .64 | .93 | .125 |
| 169C-4-2 | 1/4 | 1/8 | 7/16-24 | .86 | .61 | .74 | .188 |
| 269C-4-2 | 1/4 | 1/8 | 7/16-24 | .84 | .60 | .73 | .188 |
| 169C-4-4 | 1/4 | 1/4 | 7/16-24 | .86 | .62 | .94 | .188 |
| 269C-4-4 | 1/4 | 1/4 | 7/16-24 | .84 | .60 | .79 | .188 |
| 169C-4-6 | 1/4 | 3/8 | 7/16-24 | .93 | .68 | 1.00 | .188 |
| 169C-5-2* | 5/16 | 1/8 | 1/2-24 | .88 | .61 | .74 | .234 |
| 269C-5-2* | 5/16 | 1/8 | 1/2-24 | .86 | .60 | .73 | .250 |
| 169C-5-4 | 5/16 | 1/4 | 1/2-24 | .95 | .71 | .93 | .250 |
| 269C-5-4 | 5/16 | 1/4 | 1/2-24 | .93 | .67 | .82 | .250 |
| 169C-5-6 | 5/16 | 3/8 | 1/2-24 | 1.01 | .75 | 1.00 | .250 |
| 169C-6-2* | 3/8 | 1/8 | 9/16-24 | 1.03 | .74 | .74 | .234 |
| 269C-6-2* | 3/8 | 1/8 | 9/16-24 | .97 | .69 | .75 | .220 |
| 169C-6-4 | 3/8 | 1/4 | 9/16-24 | 1.03 | .74 | .93 | .312 |
| 269C-6-4 | 3/8 | 1/4 | 9/16-24 | 1.01 | .73 | .92 | .312 |
| 169C-6-6 | 3/8 | 3/8 | 9/16-24 | 1.03 | .75 | 1.00 | .312 |
| 269C-6-6 | 3/8 | 3/8 | 9/16-24 | 1.12 | .84 | .97 | .312 |
| 169C-6-8 | 3/8 | 1/2 | 9/16-24 | 1.22 | .94 | 1.27 | .312 |
| 269C-7-6 | 7/16 | 3/8 | 5/8-24 | 1.16 | .82 | .98 | .312 |
| 169C-8-4* | 1/2 | 1/4 | 11/16-20 | 1.34 | .94 | 1.00 | .312 |
| 169C-8-6 | 1/2 | 3/8 | 11/16-20 | 1.34 | .93 | 1.11 | .406 |
| 169C-8-8 | 1/2 | 1/2 | 11/16-20 | 1.48 | 1.00 | 1.37 | .406 |
| 169C-10-8 | 5/8 | 1/2 | 13/16-18 | 1.48 | 1.06 | 1.31 | .500 |
| 169C-12-8 | 3/4 | 1/2 | 1-18 | 1.64 | 1.18 | 1.49 | .562 |
| 169C-12-12 | 3/4 | 3/4 | 1-18 | 1.70 | 1.27 | 1.58 | .562 |

* For these parts the pipe thread through hole is smaller than the through hole on the flare end.

WARNING These products can expose you to chemicals including LEAD which is known to the state of California to cause cancer and birth defects or other reproductive harm. For more information go to www.P65Warnings.ca.gov.



Click here for CADs, Product Specifications or to Configure Parts Online

Female Elbow 170C-270C

REF. SAE 060203 BA

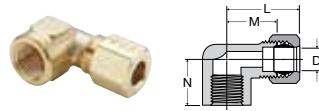

| PART NO. | TUBE SIZE | PIPE THREAD | STRAIGHT THREAD | L | M | N | FLOW DIA. D |
|------------|-----------|-------------|-----------------|------|------|------|-------------|
| 170C-2-2 | 1/8 | 1/8 | 5/16-24 | .89 | .69 | .56 | .094 |
| 170C-3-2 | 3/16 | 1/8 | 3/8-24 | .98 | .69 | .56 | .125 |
| 170C-4-2 | 1/4 | 1/8 | 7/16-24 | .93 | .69 | .56 | .188 |
| 270C-4-2 | 1/4 | 1/8 | 7/16-24 | .91 | .67 | .54 | .188 |
| 170C-4-4 | 1/4 | 1/4 | 7/16-24 | 1.02 | .78 | .67 | .188 |
| 170C-6-4 | 3/8 | 1/4 | 9/16-24 | 1.06 | .79 | .73 | .312 |
| 170C-6-6 | 3/8 | 3/8 | 9/16-24 | 1.22 | .89 | .69 | .312 |
| 170C-7-4 | 7/16 | 1/4 | 5/8-24 | 1.27 | .93 | .73 | .312 |
| 170C-8-6 | 1/2 | 3/8 | 11/16-20 | 1.34 | 1.00 | .69 | .406 |
| 170C-8-8 | 1/2 | 1/2 | 11/16-20 | 1.56 | 1.15 | .97 | .408 |
| 170C-12-12 | 3/4 | 3/4 | 1-18 | 2.06 | 1.58 | 1.58 | .563 |

Adapter Tee 176C

| PART NO. | TUBE SIZE | PIPE THREAD | STRAIGHT THREAD | L | M | N | N1 | FLOW DIA. D |
|----------|-----------|-------------|-----------------|-----|-----|-----|-----|-------------|
| 176C-4-2 | 1/4 | 1/8 | 7/16-24 | .93 | .69 | .75 | .66 | .188 |

Female Branch Tee 177C

| PART NO. | TUBE SIZE | PIPE THREAD | STRAIGHT THREAD | L | M | N | FLOW DIA. D |
|----------|-----------|-------------|-----------------|-----|-----|-----|-------------|
| 177C-4-2 | 1/4 | 1/8 | 7/16-24 | .86 | .63 | .53 | .188 |

Male Run Tee 171C

REF. SAE 060424 BA

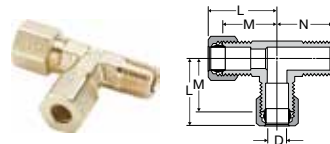

| PART NO. | TUBE SIZE | PIPE THREAD | STRAIGHT THREAD | L | M | N | FLOW DIA. D |
|----------|-----------|-------------|-----------------|------|-----|------|-------------|
| 171C-2-2 | 1/8 | 1/8 | 5/16-24 | .82 | .61 | .67 | .094 |
| 171C-3-2 | 3/16 | 1/8 | 3/8-24 | .86 | .61 | .67 | .125 |
| 171C-4-2 | 1/4 | 1/8 | 7/16-24 | .90 | .64 | .75 | .188 |
| 171C-4-4 | 1/4 | 1/4 | 7/16-24 | .93 | .69 | .92 | .188 |
| 171C-6-4 | 3/8 | 1/4 | 9/16-24 | 1.09 | .81 | 1.03 | .312 |

45° Elbow 179C

Compression to male pipe

| PART NO. | TUBE SIZE | PIPE THREAD | STRAIGHT THREAD | L | M | N | FLOW DIA. D |
|----------|-----------|-------------|-----------------|------|-----|-----|-------------|
| 179C-4-2 | 1/4 | 1/8 | 7/16-24 | .90 | .66 | .56 | .188 |
| 179C-4-4 | 1/4 | 1/4 | 7/16-24 | .80 | .56 | .84 | .188 |
| 179C-6-2 | 3/8 | 1/8 | 9/16-24 | .90 | .63 | .65 | .234 |
| 179C-6-4 | 3/8 | 1/4 | 9/16-24 | .90 | .63 | .84 | .312 |
| 179C-6-6 | 3/8 | 3/8 | 9/16-24 | .97 | .75 | .95 | .312 |
| 179C-8-6 | 1/2 | 3/8 | 11/16-20 | 1.15 | .81 | .95 | .406 |

Male Branch Tee 172C

REF. SAE 060425 BA

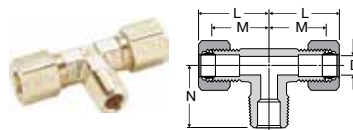

| PART NO. | TUBE SIZE | PIPE THREAD | STRAIGHT THREAD | L | M | N | FLOW DIA. D |
|----------|-----------|-------------|-----------------|------|-----|------|-------------|
| 172C-2-2 | 1/8 | 1/8 | 5/16-24 | .82 | .61 | .67 | .094 |
| 172C-3-2 | 3/16 | 1/8 | 3/8-24 | .86 | .61 | .67 | .125 |
| 172C-4-2 | 1/4 | 1/8 | 7/16-24 | .86 | .61 | .74 | .188 |
| 172C-4-4 | 1/4 | 1/4 | 7/16-24 | .93 | .69 | .92 | .188 |
| 172C-6-2 | 3/8 | 1/8 | 9/16-24 | 1.03 | .75 | .75 | .234 |
| 172C-6-4 | 3/8 | 1/4 | 9/16-24 | 1.09 | .77 | .92 | .312 |
| 172C-6-6 | 3/8 | 3/8 | 9/16-24 | 1.09 | .81 | 1.00 | .312 |
| 172C-8-6 | 1/2 | 3/8 | 11/16-20 | 1.34 | .93 | 1.10 | .406 |

Seal Plug 639C

| PART NO. | TUBE SIZE | STRAIGHT THREAD | C HEX | L | M |
|----------|-----------|-----------------|-------|-----|-----|
| 639C-4 | 1/4 | 7/16-24 | 7/16 | .74 | .50 |

Straight Through Tank Fitting 682C

| PART NO. | TUBE SIZE | PIPE THREAD | STRAIGHT THREAD | C HEX | L | M | FLOW DIA. D |
|----------|-----------|-------------|-----------------|-------|------|------|-------------|
| 682C-3-2 | 3/16 | 1/8 | 3/8-24 | 7/16 | 1.06 | .84 | .195 |
| 682C-6-6 | 3/8 | 3/8 | 9/16-24 | 11/16 | 1.44 | 1.16 | .387 |
| 682C-8-8 | 1/2 | 1/2 | 11/16-20 | 7/8 | 1.90 | 1.31 | .516 |

WARNING These products can expose you to chemicals including LEAD which is known to the state of California to cause cancer and birth defects or other reproductive harm. For more information go to www.P65Warnings.ca.gov.



- A
- B
- C
- D
- E
- F
- G
- H
- I
- J
- K
- L
- M
- N
- O

A
B
C
D
E
F
G
H
I
J
K
L
M
N
O



Compress-Align® Fittings

Parker's Compress-Align Fittings are pre-assembled with a captive sleeve, always oriented for a faster installation. The design of the captive sleeve aligns to seal even out-of-round tubing.

Product Features:

- Self-aligning captive sleeve
- 2-piece fitting – Less inventory
- Visible inspection before and after installation
- 1/8" – 1" Sizes
- No flaring, soldering or other tube preparation
- Forged and extruded shapes

Markets:

- Industrial
- Packaging
- Pneumatic
- Printing
- Chemical

Applications:

- Air lines
- Lubrication Lines
- Cooling lines
- Industry
- Machinery
- Chemical Dispensing
- Compressors
- Fluid transfer

Compatible Tubing:

- Copper, Aluminum
- Thermoplastic tubing
- TFE, FEA, PFA

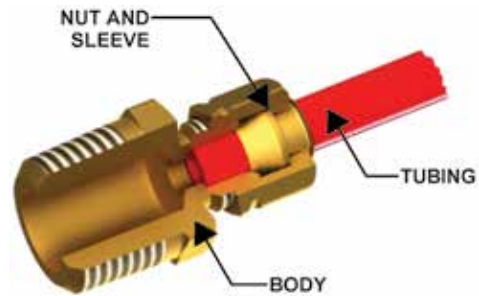

Assembly Instructions

With nut finger tight on fitting body, insert tubing until it bottoms in the Fitting. Complete the seal with one wrench turn for all sizes.



Specifications:

Temperature Range: -65° to +250° F (-53.8° to +121.1° C)

Pressure Range:

| TUBE SIZE | PSI | bar | TUBE SIZE | PSI | bar |
|-----------|------|-------|-----------|-----|------|
| 1/8 | 2800 | 193.0 | 1/2 | 750 | 51.7 |
| 3/16 | 1900 | 131.0 | 5/8 | 650 | 44.8 |
| 1/4 | 1400 | 96.5 | 3/4 | 550 | 37.9 |
| 5/16 | 1200 | 82.7 | 7/8 | 450 | 31.0 |
| 3/8 | 1000 | 68.9 | 1 | 350 | 24.1 |

WARNING These products can expose you to chemicals including LEAD which is known to the state of California to cause cancer and birth defects or other reproductive harm. For more information go to www.P65Warnings.ca.gov.

Click here for CADs, Product Specifications or to Configure Parts Online

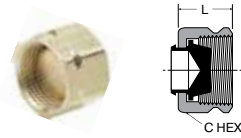

Plug 59CA

| PART NO. | TUBE SIZE | STRAIGHT THREAD | C HEX | L |
|----------|-----------|-----------------|-------|-----|
| 59CA-4 | 1/4 | 7/16-24 | 1/2 | .40 |
| 59CA-6 | 3/8 | 9/16-24 | 5/8 | .45 |
| 59CA-8 | 1/2 | 11/16-20 | 13/16 | .50 |

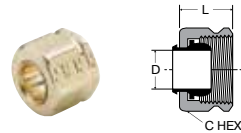

Nut and Sleeve Assembly 61CA

| PART NO. | TUBE SIZE | STRAIGHT THREAD | C HEX | D | L |
|----------|-----------|-----------------|--------|-------|-----|
| 61CA-2 | 1/8 | 5/16-24 | 3/8 | .130 | .36 |
| 61CA-3 | 3/16 | 3/8-24 | 7/16 | .194 | .38 |
| 61CA-4 | 1/4 | 7/16-24 | 1/2 | .255 | .40 |
| 61CA-5 | 5/16 | 1/2-24 | 9/16 | .318 | .45 |
| 61CA-6 | 3/8 | 9/16-24 | 5/8 | .382 | .45 |
| 61CA-8 | 1/2 | 11/16-20 | 13/16 | .507 | .50 |
| 61CA-10 | 5/8 | 13/16-18 | 15/16 | .632 | .53 |
| 61CA-12 | 3/4 | 1-18 | 1-3/16 | .760 | .56 |
| 61CA-14 | 7/8 | 1-1/8-18 | 1-3/8 | .885 | .68 |
| 61CA-16 | 1 | 1-1/4-18 | 1-1/2 | 1.012 | .63 |

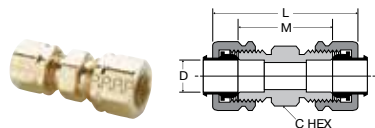

Union 62CA

| PART NO. | SIZE | STRAIGHT THREAD | C HEX | L | M | FLOW DIA. D |
|----------|------|-----------------|-------|------|------|-------------|
| 62CA-2 | 1/8 | 5/16-24 | 5/16 | 1.12 | .64 | .094 |
| 62CA-3 | 3/16 | 3/8-24 | 3/8 | 1.19 | .72 | .125 |
| 62CA-4 | 1/4 | 7/16-24 | 7/16 | 1.26 | .79 | .188 |
| 62CA-5 | 5/16 | 1/2-24 | 1/2 | 1.32 | .85 | .250 |
| 62CA-6 | 3/8 | 9/16-24 | 9/16 | 1.42 | .97 | .312 |
| 62CA-8 | 1/2 | 11/16-20 | 11/16 | 1.53 | 1.08 | .406 |
| 62CA-10 | 5/8 | 13/16-18 | 13/16 | 1.71 | 1.23 | .500 |
| 62CA-12 | 3/4 | 1-18 | 1 | 2.20 | 1.41 | .562 |
| 62CA-14 | 7/8 | 1-1/8-18 | 1-1/8 | 2.08 | 1.19 | .766 |

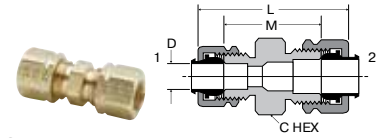

Union Reducers 62CA

| PART NO. | 1 TUBE SIZE | 2 TUBE SIZE | 1 STRAIGHT THREAD | 2 STRAIGHT THREAD | C HEX | L | M | FLOW DIA. D |
|-----------|-------------|-------------|-------------------|-------------------|-------|------|------|-------------|
| 62CA-4-3 | 3/16 | 1/4 | 3/8-24 | 7/16-24 | 7/16 | 1.25 | .78 | .125 |
| 62CA-6-4 | 1/4 | 3/8 | 7/16-24 | 9/16-24 | 9/16 | 1.37 | .91 | .188 |
| 62CA-8-6 | 3/8 | 1/2 | 9/16-24 | 11/16-20 | 11/16 | 1.48 | 1.03 | .312 |
| 62CA-10-6 | 3/8 | 5/8 | 9/16-24 | 13/16-18 | 13/16 | 1.59 | 1.13 | .312 |

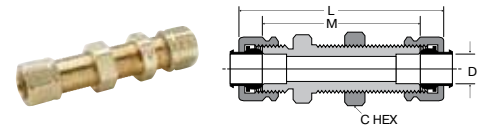

Bulkhead Union 62CABH

| PART NO. | TUBE SIZE | STRAIGHT THREAD | C HEX | L | M | BULKHEAD HOLE DIA. | FLOW DIA. D |
|----------|-----------|-----------------|-------|------|------|--------------------|-------------|
| 62CABH-4 | 1/4 | 7/16-24 | 9/16 | 2.22 | 1.75 | 7/16 | .188 |
| 62CABH-6 | 3/8 | 9/16-24 | 11/16 | 2.32 | 1.88 | 9/16 | .312 |

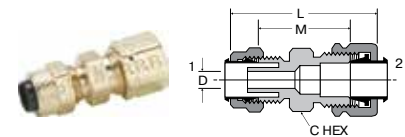

Union 62PCA

(Poly-Tite to Compress-Align)

| PART NO. | TUBE SIZE | 1 STRAIGHT THREAD | 2 STRAIGHT THREAD | C HEX | L | M | FLOW DIA. D |
|----------|-----------|-------------------|-------------------|-------|------|-----|-------------|
| 62PCA-4 | 1/4 | 3/8-24 | 7/16-24 | 7/16 | 1.24 | .89 | .125 |
| 62PCA-5 | 5/16 | 7/16-24 | 1/2-24 | 1/2 | 1.26 | .92 | .144 |
| 62PCA-6 | 3/8 | 1/2-24 | 9/16-24 | 9/16 | 1.32 | .98 | .204 |

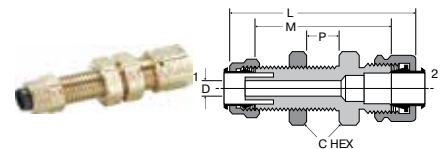

Bulkhead Union 62PCABH

(Poly-Tite to Compress-Align)

| PART NO. | TUBE SIZE | 1 STR THD | 2 STR THD | C HEX | P MAX | L | M | FLOW BKHD DIA. | FLOW DIA. D |
|-----------|-----------|-----------|-----------|-------|-------|------|------|----------------|-------------|
| 62PCABH-4 | 1/4 | 3/8-24 | 7/16-24 | 9/16 | .38 | 1.80 | 1.45 | 3/8 | .125 |
| 62PCABH-6 | 3/8 | 1/2-24 | 9/16-24 | 11/16 | .47 | 1.98 | 1.64 | 1/2 | .204 |

WARNING These products can expose you to chemicals including LEAD which is known to the state of California to cause cancer and birth defects or other reproductive harm. For more information go to www.P65Warnings.ca.gov.



[Click here for CADs, Product Specifications or to Configure Parts Online](#)

- A
- B
- C
- D
- E
- F
- G
- H
- I
- J
- K
- L
- M
- N
- O

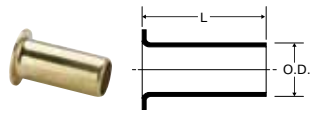

Brass Insert 63PT

| PART NO. | TUBE SIZE | TUBE WALL | L | O.D. |
|------------|-----------|-----------|-----|------|
| 63PT-2-16 | 1/8 | .016 | .46 | .080 |
| 63PT-2-23 | 1/8 | .023 | .45 | .073 |
| 63PT-3-25 | 3/16 | .025 | .45 | .135 |
| 63PT-3-40 | 3/16 | .040 | .52 | .095 |
| 63NTA-4* | 1/4 | | .53 | .163 |
| 63PT-4-62 | 1/4 | .062 | .33 | .110 |
| 63PT-5-40 | 5/16 | .040 | .50 | .232 |
| 63PT-5-62 | 5/16 | .062 | .53 | .187 |
| 63NTA-6* | 3/8 | | .64 | .245 |
| 63NTA-8* | 1/2 | | .81 | .370 |
| 63PT-10-62 | 5/8 | .062 | .72 | .483 |

* Denotes 304 stainless steel

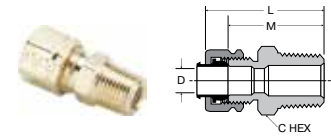

Male Connector 68CA

| PART NO. | TUBE SIZE | PIPE THREAD | STRAIGHT THREAD | C HEX | L | M | FLOW DIA. D |
|------------|-----------|-------------|-----------------|--------|------|------|-------------|
| 68CA-2-1 | 1/8 | 1/16 | 5/16-24 | 3/8 | 1.02 | .78 | .095 |
| 68CA-2-2 | 1/8 | 1/8 | 5/16-24 | 7/16 | 1.01 | .77 | .094 |
| 68CA-3-1 | 3/16 | 1/16 | 3/8-24 | 3/8 | 1.07 | .84 | .125 |
| 68CA-3-2 | 3/16 | 1/8 | 3/8-24 | 7/16 | 1.07 | .84 | .125 |
| 68CA-3-4 | 3/16 | 1/4 | 3/8-24 | 9/16 | 1.26 | 1.03 | .125 |
| 68CA-4-2 | 1/4 | 1/8 | 7/16-24 | 7/16 | 1.10 | .86 | .188 |
| 68CA-4-4 | 1/4 | 1/4 | 7/16-24 | 9/16 | 1.31 | 1.06 | .188 |
| 68CA-4-6 | 1/4 | 3/8 | 7/16-24 | 11/16 | 1.28 | 1.03 | .188 |
| 68CA-4-8 | 1/4 | 1/2 | 7/16-24 | 7/8 | 1.56 | 1.31 | .188 |
| 68CA-5-2 | 5/16 | 1/8 | 1/2-24 | 1/2 | 1.13 | .89 | .234 |
| 68CA-5-4 | 5/16 | 1/4 | 1/2-24 | 9/16 | 1.35 | 1.07 | .250 |
| 68CA-6-2 | 3/8 | 1/8 | 9/16-24 | 9/16 | 1.19 | .97 | .250 |
| 68CA-6-4 | 3/8 | 1/4 | 9/16-24 | 9/16 | 1.36 | 1.14 | .312 |
| 68CA-6-6 | 3/8 | 3/8 | 9/16-24 | 11/16 | 1.43 | 1.16 | .312 |
| 68CA-6-8 | 3/8 | 1/2 | 9/16-24 | 7/8 | 1.52 | 1.25 | .312 |
| 68CA-8-4 | 1/2 | 1/4 | 11/16-20 | 11/16 | 1.45 | 1.22 | .312 |
| 68CA-8-6 | 1/2 | 3/8 | 11/16-20 | 11/16 | 1.43 | 1.20 | .406 |
| 68CA-8-8 | 1/2 | 1/2 | 11/16-20 | 7/8 | 1.54 | 1.31 | .406 |
| 68CA-10-6 | 5/8 | 3/8 | 13/16-18 | 13/16 | 1.55 | 1.31 | .406 |
| 68CA-10-8 | 5/8 | 1/2 | 13/16-18 | 7/8 | 1.72 | 1.48 | .500 |
| 68CA-10-12 | 5/8 | 3/4 | 13/16-18 | 1-1/16 | 1.80 | 1.56 | .500 |
| 68CA-12-8 | 3/4 | 1/2 | 1-18 | 1 | 1.99 | 1.60 | .562 |
| 68CA-12-12 | 3/4 | 3/4 | 1-18 | 1-1/16 | 2.02 | 1.63 | .656 |
| 68CA-14-12 | 7/8 | 3/4 | 1-1/8-18 | 1-1/8 | 1.85 | 1.41 | .750 |
| 68CA-16-12 | 1 | 3/4 | 1-1/4-18 | 1-1/4 | 1.83 | 1.39 | .750 |
| 68CA-16-16 | 1 | 1 | 1-1/4-18 | 1-3/8 | 2.02 | 1.58 | .875 |

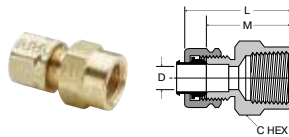

Female Connector 66CA

| PART NO. | TUBE SIZE | PIPE THREAD | STRAIGHT THREAD | C HEX | L | M | FLOW DIA. D |
|-----------|-----------|-------------|-----------------|-------|------|------|-------------|
| 66CA-2-2 | 1/8 | 1/8 | 5/16-24 | 9/16 | .99 | .75 | .094 |
| 66CA-3-2 | 3/16 | 1/8 | 3/8-24 | 9/16 | 1.01 | .78 | .125 |
| 66CA-3-4 | 3/16 | 1/4 | 3/8-24 | 11/16 | 1.19 | .96 | .125 |
| 66CA-4-2 | 1/4 | 1/8 | 7/16-24 | 9/16 | 1.02 | .78 | .188 |
| 66CA-4-4 | 1/4 | 1/4 | 7/16-24 | 11/16 | 1.24 | 1.00 | .188 |
| 66CA-5-2 | 5/16 | 1/8 | 1/2-24 | 9/16 | 1.05 | .81 | .250 |
| 66CA-5-4 | 5/16 | 1/4 | 1/2-24 | 11/16 | 1.27 | 1.03 | .250 |
| 66CA-6-2 | 3/8 | 1/8 | 9/16-24 | 9/16 | 1.00 | .78 | .312 |
| 66CA-6-4 | 3/8 | 1/4 | 9/16-24 | 11/16 | 1.28 | 1.06 | .312 |
| 66CA-6-6 | 3/8 | 3/8 | 9/16-24 | 13/16 | 1.29 | 1.06 | .312 |
| 66CA-6-8 | 3/8 | 1/2 | 9/16-24 | 1 | 1.49 | 1.27 | .312 |
| 66CA-8-4 | 1/2 | 1/4 | 11/16-20 | 11/16 | 1.32 | 1.09 | .406 |
| 66CA-8-6 | 1/2 | 3/8 | 11/16-20 | 13/16 | 1.35 | 1.12 | .406 |
| 66CA-8-8 | 1/2 | 1/2 | 11/16-20 | 1 | 1.54 | 1.31 | .406 |
| 66CA-10-8 | 5/8 | 1/2 | 13/16-18 | 1 | 1.62 | 1.38 | .500 |

WARNING These products can expose you to chemicals including LEAD which is known to the state of California to cause cancer and birth defects or other reproductive harm. For more information go to www.P65Warnings.ca.gov.



Click here for CADs, Product Specifications or to Configure Parts Online

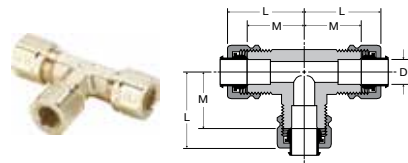

**Union Tee
164CA-264CA**

| PART NO. | TUBE SIZE | STRAIGHT THREAD | L | M | FLOW DIA. D |
|----------|-----------|-----------------|------|------|-------------|
| 164CA-2 | 1/8 | 5/16-24 | .84 | .61 | .093 |
| 264CA-3 | 3/16 | 3/8-24 | .83 | .60 | .125 |
| 164CA-4 | 1/4 | 7/16-24 | .84 | .63 | .188 |
| 264CA-4 | 1/4 | 7/16-24 | .84 | .60 | .188 |
| 164CA-5 | 5/16 | 1/2-24 | .95 | .71 | .250 |
| 164CA-6 | 3/8 | 9/16-24 | .96 | .74 | .312 |
| 164CA-8 | 1/2 | 11/16-20 | 1.15 | .93 | .406 |
| 164CA-10 | 5/8 | 13/16-18 | 1.32 | 1.08 | .500 |
| 164CA-12 | 3/4 | 1.00-18 | 1.56 | 1.17 | .562 |

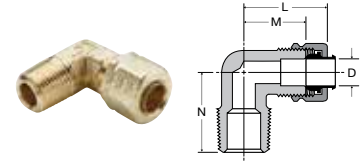

**Male Elbow
169CA-269CA**

| PART NO. | TUBE SIZE | PIPE THREAD | STRAIGHT THREAD | L | M | N | FLOW DIA. D |
|--------------------------|-----------|-------------|-----------------|------|------|------|-------------|
| 169CA-2-1 | 1/8 | 1/16 | 5/16-24 | .84 | .60 | .67 | .095 |
| 269CA-2-2 | 1/8 | 1/8 | 5/16-24 | .84 | .60 | .67 | .094 |
| 169CA-3-1 | 3/16 | 1/16 | 3/8-24 | .84 | .61 | .67 | .126 |
| 169CA-3-2 | 3/16 | 1/8 | 3/8-24 | .84 | .61 | .69 | .125 |
| 269CA-3-2 | 3/16 | 1/8 | 3/8-24 | .83 | .60 | .67 | .125 |
| 169CA-3-4 | 3/16 | 1/4 | 3/8-24 | .87 | .64 | .93 | .125 |
| 169CA-4-2 | 1/4 | 1/8 | 7/16-24 | .84 | .61 | .74 | .188 |
| 269CA-4-2 | 1/4 | 1/8 | 7/16-24 | .84 | .60 | .73 | .188 |
| 169CA-4-4 | 1/4 | 1/4 | 7/16-24 | .86 | .62 | .94 | .188 |
| 269CA-4-4 | 1/4 | 1/4 | 7/16-24 | .84 | .60 | .79 | .188 |
| 169CA-4-6 | 1/4 | 3/8 | 7/16-24 | .92 | .68 | 1.00 | .188 |
| 169CA-5-2 ⁺ | 5/16 | 1/8 | 1/2-24 | .84 | .61 | .74 | .234 |
| 269CA-5-2 ⁺ | 5/16 | 1/8 | 1/2-24 | .84 | .60 | .73 | .250 |
| 169CA-5-4 | 5/16 | 1/4 | 1/2-24 | .94 | .71 | .93 | .250 |
| 269CA-5-4 | 5/16 | 1/4 | 1/2-24 | .91 | .67 | .82 | .250 |
| 169CA-5-6 | 5/16 | 3/8 | 1/2-24 | .99 | .75 | 1.00 | .250 |
| 169CA-6-2 ⁺ | 3/8 | 1/8 | 9/16-24 | .96 | .74 | .74 | .234 |
| 269CA-6-2 ⁺ | 3/8 | 1/8 | 9/16-24 | .96 | .69 | .75 | .220 |
| 169CA-6-4 | 3/8 | 1/4 | 9/16-24 | .96 | .74 | .93 | .312 |
| 269CA-6-4 | 3/8 | 1/4 | 9/16-24 | .95 | .73 | .92 | .312 |
| 169CA-6-6 | 3/8 | 3/8 | 9/16-24 | .97 | .75 | 1.00 | .312 |
| 269CA-6-6 | 3/8 | 3/8 | 9/16-24 | 1.06 | .84 | .97 | .312 |
| 169CA-6-8 | 3/8 | 1/2 | 9/16-24 | 1.16 | .94 | 1.27 | .312 |
| 169CA-8-4 ⁺ | 1/2 | 1/4 | 11/16-20 | 1.17 | .94 | 1.00 | .312 |
| 169CA-8-6 | 1/2 | 3/8 | 11/16-20 | 1.15 | .93 | 1.11 | .406 |
| 169CA-8-8 | 1/2 | 1/2 | 11/16-20 | 1.23 | 1.00 | 1.37 | .406 |
| 169CA-10-6 ⁺ | 5/8 | 3/8 | 13/16-18 | 1.30 | 1.06 | 1.15 | .406 |
| 169CA-10-8 | 5/8 | 1/2 | 13/16-18 | 1.30 | 1.06 | 1.31 | .500 |
| 169CA-12-8 | 3/4 | 1/2 | 1-18 | 1.57 | 1.18 | 1.49 | .562 |
| 169CA-12-12 | 3/4 | 3/4 | 1-18 | 1.66 | 1.27 | 1.58 | .562 |
| 169CA-16-12 ⁺ | 1 | 3/4 | 1-1/4-18 | 1.63 | 1.19 | 1.60 | .875 |

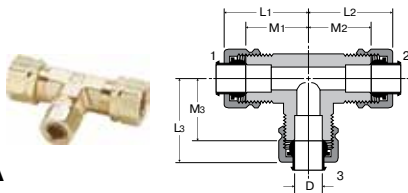

**Union Tee 164CA
combination sizes**

| PART NO. | 1 TUBE SIZE | 2 TUBE SIZE | 3 TUBE SIZE | L1 | L2 | L3 | M1 | M2 | M3 | FLOW DIA. D |
|-------------|-------------|-------------|-------------|------|------|------|-----|-----|-----|-------------|
| 164CA-6-4-4 | 3/8 | 1/4 | 1/4 | .97 | .96 | .96 | .75 | .72 | .72 | .188 |
| 164CA-6-6-4 | 3/8 | 3/8 | 1/4 | .97 | .97 | .96 | .75 | .75 | .72 | .188 |
| 164CA-8-8-6 | 1/2 | 1/2 | 3/8 | 1.17 | 1.17 | 1.10 | .94 | .94 | .88 | .312 |

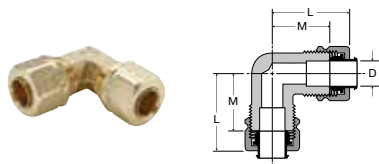

**Union Elbow
165CA-265CA**

| PART NO. | TUBE SIZE | STRAIGHT THREAD | L | M | FLOW DIA. D |
|----------|-----------|-----------------|------|------|-------------|
| 165CA-2 | 1/8 | 5/16-24 | .84 | .61 | .094 |
| 165CA-3 | 3/16 | 3/8-24 | .84 | .61 | .125 |
| 165CA-4 | 1/4 | 7/16-24 | .84 | .61 | .188 |
| 265CA-4 | 1/4 | 7/16-24 | .84 | .60 | .188 |
| 165CA-5 | 5/16 | 1/2-24 | .94 | .71 | .250 |
| 165CA-6 | 3/8 | 9/16-24 | .96 | .74 | .312 |
| 165CA-8 | 1/2 | 11/16-20 | 1.15 | .93 | .406 |
| 165CA-10 | 5/8 | 13/16-18 | 1.29 | 1.05 | .500 |
| 165CA-12 | 3/4 | 1-18 | 1.56 | 1.17 | .562 |
| 165CA-16 | 1 | 1-1/4-18 | 1.63 | 1.19 | .877 |

⁺ For these parts the pipe thread through hole is smaller than the through hole on the tube end.

WARNING These products can expose you to chemicals including LEAD which is known to the state of California to cause cancer and birth defects or other reproductive harm. For more information go to www.P65Warnings.ca.gov.

- A
- B
- C
- D
- E
- F
- G
- H
- I
- J
- K
- L
- M
- N
- O

Click here for CADs, Product Specifications or to Configure Parts Online

- A
- B
- C
- D
- E
- F
- G
- H
- I
- J
- K
- L
- M
- N
- O

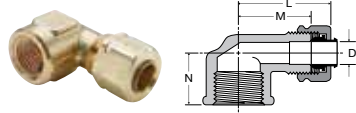

**Female Elbow
170CA-270CA**

| PART NO. | TUBE SIZE | PIPE THREAD | STRAIGHT THREAD | L | M | N | FLOW DIA. D |
|-------------|-----------|-------------|-----------------|------|------|------|-------------|
| 170CA-2-2 | 1/8 | 1/8 | 5/16-24 | .93 | .69 | .56 | .094 |
| 170CA-3-2 | 3/16 | 1/8 | 3/8-24 | .98 | .69 | .56 | .125 |
| 170CA-4-2 | 1/4 | 1/8 | 7/16-24 | .98 | .69 | .56 | .188 |
| 270CA-4-2 | 1/4 | 1/8 | 7/16-24 | .91 | .67 | .54 | .188 |
| 170CA-4-4 | 1/4 | 1/4 | 7/16-24 | 1.02 | .78 | .67 | .188 |
| 170CA-6-4 | 3/8 | 1/4 | 9/16-24 | 1.09 | .79 | .73 | .312 |
| 170CA-6-6 | 3/8 | 3/8 | 9/16-24 | 1.16 | .89 | .69 | .312 |
| 170CA-8-6 | 1/2 | 3/8 | 11/16-20 | 1.23 | 1.00 | .69 | .406 |
| 170CA-8-8 | 1/2 | 1/2 | 11/16-20 | 1.38 | 1.15 | .97 | .408 |
| 170CA-12-12 | 3/4 | 3/4 | 1-18 | 1.97 | 1.58 | 1.58 | .563 |

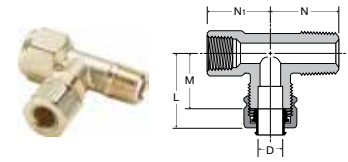

Adapter Tee 176CA

| PART NO. | TUBE SIZE | PIPE THREAD | STRAIGHT THREAD | L | M | N | N1 | FLOW DIA. D |
|-----------|-----------|-------------|-----------------|-----|-----|-----|-----|-------------|
| 176CA-4-2 | 1/4 | 1/8 | 7/16-24 | .92 | .69 | .75 | .66 | .188 |

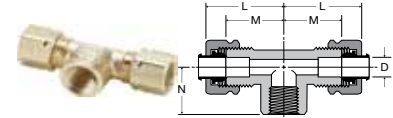

Female Branch Tee 177CA

| PART NO. | TUBE SIZE | PIPE THREAD | STRAIGHT THREAD | L | M | N | FLOW DIA. D |
|-----------|-----------|-------------|-----------------|-----|-----|-----|-------------|
| 177CA-4-2 | 1/4 | 1/8 | 7/16-24 | .86 | .63 | .53 | .188 |

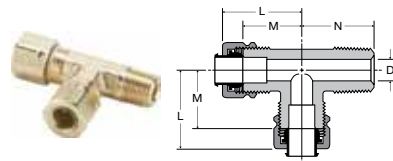

Male Run Tee 171CA

| PART NO. | TUBE SIZE | PIPE THREAD | STRAIGHT THREAD | L | M | N | FLOW DIA. D |
|-----------|-----------|-------------|-----------------|------|-----|------|-------------|
| 171CA-2-2 | 1/8 | 1/8 | 5/16-24 | .84 | .61 | .67 | .094 |
| 171CA-3-2 | 3/16 | 1/8 | 3/8-24 | .83 | .61 | .67 | .125 |
| 171CA-4-2 | 1/4 | 1/8 | 7/16-24 | .88 | .64 | .75 | .188 |
| 171CA-4-4 | 1/4 | 1/4 | 7/16-24 | .93 | .69 | .92 | .188 |
| 171CA-6-4 | 3/8 | 1/4 | 9/16-24 | 1.03 | .81 | 1.03 | .312 |

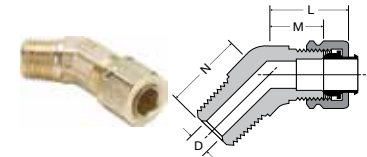

45° Elbow 179CA

| PART NO. | TUBE SIZE | PIPE THREAD | STRAIGHT THREAD | L | M | N | FLOW DIA. D |
|-----------|-----------|-------------|-----------------|------|-----|-----|-------------|
| 179CA-4-2 | 1/4 | 1/8 | 7/16-24 | .89 | .66 | .56 | .188 |
| 179CA-4-4 | 1/4 | 1/4 | 7/16-24 | .80 | .56 | .84 | .188 |
| 179CA-6-2 | 3/8 | 1/8 | 9/16-24 | .85 | .63 | .65 | .234 |
| 179CA-6-4 | 3/8 | 1/4 | 9/16-24 | .85 | .63 | .84 | .312 |
| 179CA-6-6 | 3/8 | 3/8 | 9/16-24 | .97 | .75 | .95 | .312 |
| 179CA-8-6 | 1/2 | 3/8 | 11/16-20 | 1.03 | .81 | .95 | .406 |

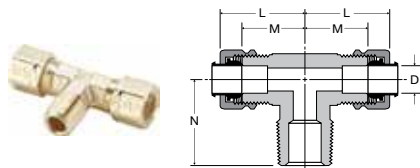

Male Branch Tee 172CA

| PART NO. | TUBE SIZE | PIPE THREAD | STRAIGHT THREAD | L | M | N | FLOW DIA. D |
|-------------|-----------|-------------|-----------------|------|------|------|-------------|
| 172CA-2-2 | 1/8 | 1/8 | 5/16-24 | .84 | .61 | .67 | .093 |
| 172CA-3-2 | 3/16 | 1/8 | 3/8-24 | .83 | .61 | .67 | .125 |
| 172CA-4-2 | 1/4 | 1/8 | 7/16-24 | .84 | .61 | .74 | .188 |
| 172CA-4-4 | 1/4 | 1/4 | 7/16-24 | .93 | .69 | .92 | .188 |
| 172CA-6-2 | 3/8 | 1/8 | 9/16-24 | .97 | .75 | .75 | .234 |
| 172CA-6-4 | 3/8 | 1/4 | 9/16-24 | .99 | .77 | .92 | .312 |
| 172CA-6-6 | 3/8 | 3/8 | 9/16-24 | 1.07 | .81 | 1.00 | .312 |
| 172CA-8-6 | 1/2 | 3/8 | 11/16-20 | 1.15 | .93 | 1.10 | .406 |
| 172CA-12-12 | 3/4 | 3/4 | 1-18 | 1.67 | 1.27 | 1.50 | .562 |

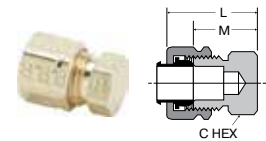

Seal Plug 639CA

| PART NO. | TUBE SIZE | STRAIGHT THREAD | C HEX | L | M |
|----------|-----------|-----------------|-------|-----|-----|
| 639CA-4 | 1/4 | 7/16-24 | 7/16 | .74 | .50 |

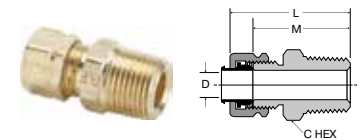

Straight Through Tank Fitting 682CA

| PART NO. | TUBE SIZE | PIPE THREAD | STRAIGHT THREAD | C HEX | L | M | FLOW DIA. D |
|-----------|-----------|-------------|-----------------|-------|------|-----|-------------|
| 682CA-3-2 | 3/16 | 1/8 | 3/8-24 | 7/16 | 1.07 | .84 | .194 |

WARNING These products can expose you to chemicals including LEAD which is known to the state of California to cause cancer and birth defects or other reproductive harm. For more information go to www.P65Warnings.ca.gov.



Brass Metric Compression Fittings



Parker's Metric Compression Fittings provide users with an economical choice with numerous connection options for a wide variety of tube materials without the need for flaring, soldering or other tube preparation necessary to assemble.

Product Features:

- 4mm – 28mm tube sizes
- NPT, BSPT, BSPP, Metric Threads
- NBR seal
- Silicone free

Markets:

- Factory/Process Automation
- Automotive Process
- Packaging
- Pneumatic
- Printing

Applications:

- Air lines
- Lubrication Lines
- Cooling lines
- Water
- Machinery
- Compressors
- Fluid transfer

Compatible Tubing:

- Copper
- Aluminum
- Thermoplastic tubing

Specifications:

Temperature Range: -40° to +250° F (-40° to +121.1° C)

Pressure Range:

| TUBE SIZE MM | PSI | bar | TUBE SIZE MM | PSI | bar |
|--------------|------|-------|--------------|-----|------|
| 4 | 3335 | 229.9 | 14 | 652 | 44.9 |
| 6 | 2175 | 149.9 | 16 | 580 | 39.9 |
| 8 | 1450 | 99.9 | 18 | 536 | 36.9 |
| 10 | 1087 | 74.9 | 20 | 507 | 34.9 |
| 12 | 797 | 54.9 | 22 | 435 | 29.9 |

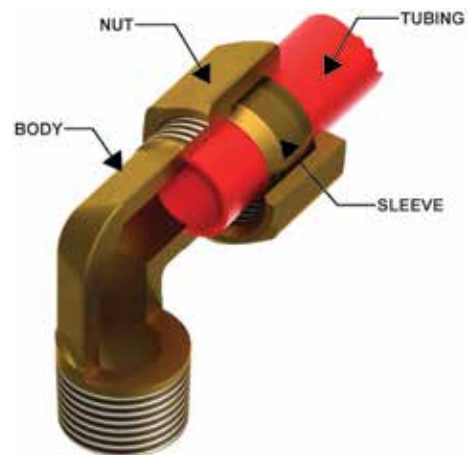

WARNING These products can expose you to chemicals including LEAD which is known to the state of California to cause cancer and birth defects or other reproductive harm. For more information go to www.P65Warnings.ca.gov.



[Click here for CADs, Product Specifications or to Configure Parts Online](#)

- A
- B
- C
- D
- E
- F
- G
- H
- I
- J
- K
- L
- M
- N
- O

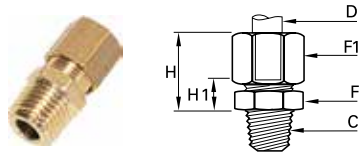

0105 Male Connector BSPT

| PART NO. | OD | C | F | F1 | H MAX | H1 | KG |
|------------|----|------|----|----|-------|------|------|
| 0105 04 10 | 4 | R1/8 | 10 | 10 | 17 | 7 | .012 |
| 0105 05 10 | 5 | R1/8 | 11 | 12 | 17.5 | 7.5 | .016 |
| 0105 05 13 | 5 | R1/4 | 14 | 12 | 17.5 | 7.5 | .022 |
| 0105 06 10 | 6 | R1/8 | 11 | 13 | 18 | 7.5 | .017 |
| 0105 06 13 | 6 | R1/4 | 14 | 13 | 18 | 7.5 | .024 |
| 0105 06 17 | 6 | R3/8 | 17 | 13 | 18 | 8.5 | .031 |
| 0105 08 10 | 8 | R1/8 | 13 | 14 | 19.5 | 7 | .020 |
| 0105 08 13 | 8 | R1/4 | 14 | 14 | 19.5 | 7 | .025 |
| 0105 08 17 | 8 | R3/8 | 17 | 14 | 20.5 | 8 | .032 |
| 0105 10 10 | 10 | R1/8 | 17 | 19 | 24 | 9 | .043 |
| 0105 10 13 | 10 | R1/4 | 17 | 19 | 24 | 9 | .047 |
| 0105 10 17 | 10 | R3/8 | 17 | 19 | 24 | 9 | .048 |
| 0105 10 21 | 10 | R1/2 | 22 | 19 | 25 | 10 | .067 |
| 0105 12 13 | 12 | R1/4 | 19 | 22 | 24 | 9 | .059 |
| 0105 12 17 | 12 | R3/8 | 19 | 22 | 24 | 9 | .060 |
| 0105 12 21 | 12 | R1/2 | 22 | 22 | 25 | 10 | .076 |
| 0105 14 13 | 14 | R1/4 | 22 | 24 | 25 | 8 | .068 |
| 0105 14 17 | 14 | R3/8 | 22 | 24 | 25 | 8 | .068 |
| 0105 14 21 | 14 | R1/2 | 22 | 24 | 26 | 9 | .080 |
| 0105 14 27 | 14 | R3/4 | 27 | 24 | 27 | 10 | .107 |
| 0105 15 17 | 15 | R3/8 | 22 | 24 | 25 | 8 | .065 |
| 0105 15 21 | 15 | R1/2 | 22 | 24 | 26 | 9 | .076 |
| 0105 16 13 | 16 | R1/4 | 24 | 27 | 27 | 9.5 | .092 |
| 0105 16 17 | 16 | R3/8 | 24 | 27 | 27 | 9.5 | .092 |
| 0105 16 21 | 16 | R1/2 | 24 | 27 | 27 | 9.5 | .099 |
| 0105 16 27 | 16 | R3/4 | 27 | 27 | 28 | 10.5 | .123 |
| 0105 18 21 | 18 | R1/2 | 27 | 30 | 30 | 10.5 | .127 |
| 0105 18 27 | 18 | R3/4 | 27 | 30 | 30 | 10.5 | .138 |
| 0105 20 21 | 20 | R1/2 | 30 | 32 | 32 | 11 | .148 |
| 0105 20 27 | 20 | R3/4 | 30 | 32 | 32 | 11 | .157 |
| 0105 22 21 | 22 | R1/2 | 32 | 36 | 33 | 11 | .187 |
| 0105 22 27 | 22 | R3/4 | 32 | 36 | 33 | 11 | .196 |
| 0105 22 34 | 22 | R1 | 36 | 36 | 33 | 11 | .227 |
| 0105 25 27 | 25 | R3/4 | 36 | 41 | 36 | 11 | .261 |
| 0105 25 34 | 25 | R1 | 36 | 41 | 36 | 11 | .278 |
| 0105 28 27 | 28 | R3/4 | 41 | 42 | 36 | 11 | .274 |
| 0105 28 34 | 28 | R1 | 41 | 42 | 36 | 11 | .283 |

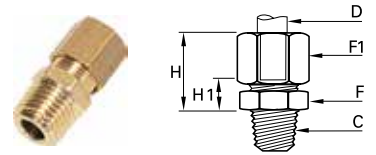

0105 Male Connector NPT

| PART NO. | OD | C | F | F1 | H MAX | H1 | KG |
|------------|----|--------|----|----|-------|-----|------|
| 0105 06 11 | 6 | NPT1/8 | 11 | 13 | 18 | 7.5 | .018 |
| 0105 06 14 | 6 | NPT1/4 | 14 | 13 | 18 | 7.5 | .027 |
| 0105 08 11 | 8 | NPT1/8 | 13 | 14 | 21 | 7 | .021 |
| 0105 08 14 | 8 | NPT1/4 | 14 | 14 | 18.5 | 7 | .026 |
| 0105 10 14 | 10 | NPT1/4 | 17 | 19 | 24 | 9 | .048 |
| 0105 10 18 | 10 | NPT3/8 | 17 | 19 | 24 | 9 | .048 |
| 0105 10 22 | 10 | NPT1/2 | 22 | 19 | 25 | 10 | .066 |

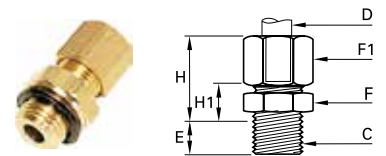

0101 Male Connector with Captive Sealing Washer Male BSPP

| PART NO. | OD | C | E | F | F1 | H MAX | H1 | KG |
|------------|----|--------|-----|----|----|-------|------|------|
| 0101 04 19 | 4 | M5X0.8 | 5 | 10 | 10 | 16.5 | 8 | .011 |
| 0101 04 10 | 4 | G1/8 | 6.5 | 13 | 10 | 16.5 | 8 | .016 |
| 0101 05 10 | 5 | G1/8 | 6.5 | 13 | 12 | 17.5 | 8.5 | .018 |
| 0101 06 10 | 6 | G1/8 | 6.5 | 13 | 13 | 18 | 8.5 | .020 |
| 0101 06 13 | 6 | G1/4 | 8 | 17 | 13 | 18 | 9.5 | .030 |
| 0101 08 10 | 8 | G1/8 | 6.5 | 13 | 14 | 19 | 8.5 | .021 |
| 0101 08 13 | 8 | G1/4 | 8 | 17 | 14 | 19.5 | 9 | .032 |
| 0101 08 17 | 8 | G3/8 | 11 | 22 | 14 | 20 | 10.5 | .044 |
| 0101 10 13 | 10 | G1/4 | 8 | 17 | 19 | 24 | 11 | .049 |
| 0101 10 17 | 10 | G3/8 | 11 | 22 | 19 | 24 | 11.5 | .061 |
| 0101 12 13 | 12 | G1/4 | 8 | 19 | 22 | 24 | 11 | .062 |
| 0101 12 17 | 12 | G3/8 | 11 | 22 | 22 | 24 | 11.5 | .069 |
| 0101 12 21 | 12 | G1/2 | 12 | 27 | 22 | 24 | 12 | .089 |
| 0101 14 17 | 14 | G3/8 | 11 | 22 | 24 | 25 | 10.5 | .074 |
| 0101 14 21 | 14 | G1/2 | 12 | 27 | 24 | 25 | 11 | .094 |
| 0101 15 17 | 15 | G3/8 | 11 | 22 | 24 | 25 | 10.5 | .071 |
| 0101 15 21 | 15 | G1/2 | 12 | 27 | 24 | 25 | 11 | .093 |
| 0101 16 17 | 16 | G3/8 | 11 | 22 | 27 | 27 | 12 | .092 |
| 0101 16 21 | 16 | G1/2 | 12 | 27 | 27 | 27 | 12.5 | .109 |
| 0101 18 21 | 18 | G1/2 | 12 | 27 | 30 | 29.5 | 12.5 | .128 |
| 0101 18 27 | 18 | G3/4 | 13 | 32 | 30 | 29.5 | 13 | .152 |
| 0101 20 27 | 20 | G3/4 | 13 | 32 | 32 | 31 | 13 | .164 |
| 0101 22 27 | 22 | G3/4 | 13 | 32 | 36 | 32 | 13 | .195 |
| 0101 22 34 | 22 | G1 | 15 | 41 | 36 | 31 | 13.5 | .259 |
| 0101 25 27 | 25 | G3/4 | 13 | 36 | 41 | 35.5 | 13 | .261 |
| 0101 25 34 | 25 | G1 | 15 | 41 | 41 | 35.5 | 13 | .169 |
| 0101 28 34 | 28 | G1 | 15 | 41 | 42 | 35.5 | 13.5 | .300 |

With pre-assembled captive polymer sealing washer

WARNING These products can expose you to chemicals including LEAD which is known to the state of California to cause cancer and birth defects or other reproductive harm. For more information go to www.P65Warnings.ca.gov.



[Click here for CADs, Product Specifications or to Configure Parts Online](#)

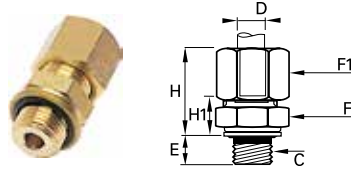

0101 Male Connector with Bi-Material Seal Male BSPP

| PART NO. | OD | C | E | F | F1 | H MAX | H1 | KG |
|---------------|----|------|------|----|----|-------|------|------|
| 0101 04 10 39 | 4 | G1/8 | 5.5 | 13 | 10 | 17.5 | 9 | .016 |
| 0101 05 10 39 | 5 | G1/8 | 5.5 | 13 | 12 | 18.5 | 9.5 | .019 |
| 0101 06 10 39 | 6 | G1/8 | 5.5 | 13 | 13 | 19 | 9.5 | .020 |
| 0101 06 13 39 | 6 | G1/4 | 7 | 17 | 13 | 19 | 10.5 | .030 |
| 0101 08 10 39 | 8 | G1/8 | 5.5 | 13 | 14 | 20 | 9.5 | .022 |
| 0101 08 13 39 | 8 | G1/4 | 7 | 17 | 14 | 20.5 | 10 | .032 |
| 0101 08 17 39 | 8 | G3/8 | 9.5 | 22 | 14 | 21.5 | 12 | .045 |
| 0101 10 13 39 | 10 | G1/4 | 7 | 17 | 19 | 25 | 12 | .048 |
| 0101 10 17 39 | 10 | G3/8 | 9.5 | 22 | 19 | 25.5 | 13 | .062 |
| 0101 12 13 39 | 12 | G1/4 | 7 | 19 | 22 | 25 | 12 | .063 |
| 0101 12 17 39 | 12 | G3/8 | 9.5 | 22 | 22 | 25 | 13 | .071 |
| 0101 12 21 39 | 12 | G1/2 | 10.5 | 27 | 22 | 25 | 13.5 | .091 |
| 0101 14 17 39 | 14 | G3/8 | 9.5 | 22 | 24 | 26.5 | 12 | .075 |
| 0101 14 21 39 | 14 | G1/2 | 10.5 | 27 | 24 | 26.5 | 12.5 | .095 |
| 0101 15 17 39 | 15 | G3/8 | 9.5 | 22 | 24 | 26.5 | 12 | .073 |
| 0101 15 21 39 | 15 | G1/2 | 10.5 | 27 | 24 | 26.5 | 12.5 | .095 |
| 0101 16 17 39 | 16 | G3/8 | 9.5 | 22 | 27 | 28.5 | 13.5 | .092 |
| 0101 16 21 39 | 16 | G1/2 | 10.5 | 27 | 27 | 28.5 | 14 | .111 |
| 0101 18 21 39 | 18 | G1/2 | 10.5 | 27 | 30 | 31 | 14 | .129 |
| 0101 18 27 39 | 18 | G3/4 | 11.5 | 32 | 30 | 31 | 14.5 | .155 |
| 0101 20 27 39 | 20 | G3/4 | 11.5 | 32 | 32 | 32.5 | 14.5 | .164 |
| 0101 22 27 39 | 22 | G3/4 | 11.5 | 32 | 36 | 32.5 | 14.5 | .197 |
| 0101 22 34 39 | 22 | G1 | 13 | 41 | 36 | 33 | 15.5 | .259 |
| 0101 25 34 39 | 25 | G1 | 13 | 41 | 41 | 37.5 | 15.5 | .309 |
| 0101 28 34 39 | 28 | G1 | 13 | 41 | 42 | 37.5 | 15.5 | .301 |

Zinc plated steel with NBR seal

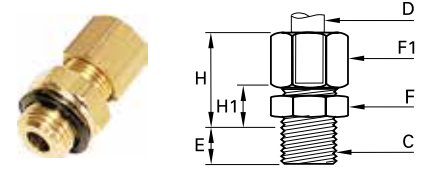

0101 Male Connector Metric Thread

| PART NO. | OD | C | E | F | F1 | H MAX | H1 | KG |
|------------|----|----------|-----|----|----|-------|------|------|
| 0101 04 55 | 4 | M7X1 | 6.5 | 10 | 10 | 16.5 | 7.5 | .012 |
| 0101 04 56 | 4 | M8X1 | 6.5 | 11 | 10 | 16.5 | 7.5 | .013 |
| 0101 05 56 | 5 | M8X1 | 6.5 | 11 | 12 | 17.5 | 8 | .016 |
| 0101 05 60 | 5 | M10X1 | 6.5 | 14 | 12 | 17.5 | 8.5 | .020 |
| 0101 06 60 | 6 | M10X1 | 6.5 | 14 | 13 | 18 | 8.5 | .021 |
| 0101 06 62 | 6 | M10X1.5 | 6.5 | 14 | 13 | 18 | 8.5 | .021 |
| 0101 08 65 | 8 | M12X1 | 8 | 17 | 14 | 19.5 | 9 | .029 |
| 0101 08 66 | 8 | M12X1.25 | 8 | 17 | 14 | 19.5 | 9 | .029 |
| 0101 08 68 | 8 | M13X1.25 | 8 | 17 | 14 | 19.5 | 9 | .030 |
| 0101 10 70 | 10 | M14X1.25 | 8 | 17 | 19 | 24 | 11 | .047 |
| 0101 10 71 | 10 | M14X1.5 | 8 | 17 | 19 | 24 | 11 | .047 |
| 0101 10 74 | 10 | M16X1.25 | 9 | 19 | 19 | 24 | 11 | .051 |
| 0101 10 75 | 10 | M16X1.5 | 9 | 19 | 19 | 24 | 11 | .051 |
| 0101 10 78 | 10 | M18X1.5 | 9 | 22 | 19 | 24 | 11.5 | .060 |
| 0101 12 74 | 12 | M16X1.25 | 9 | 19 | 22 | 24 | 11 | .061 |
| 0101 12 75 | 12 | M16X1.5 | 9 | 19 | 22 | 24 | 11 | .061 |
| 0101 12 78 | 12 | M18X1.5 | 9 | 22 | 22 | 24 | 11.5 | .070 |
| 0101 14 78 | 14 | M18X1.5 | 9 | 22 | 24 | 25 | 10.5 | .077 |
| 0101 14 80 | 14 | M20X1.5 | 10 | 24 | 24 | 25 | 11 | .084 |
| 0101 15 78 | 15 | M18X1.5 | 9 | 22 | 24 | 25 | 10.5 | .071 |
| 0101 16 80 | 16 | M20X1.5 | 10 | 24 | 27 | 27 | 12.5 | .102 |
| 0101 16 82 | 16 | M22X1.5 | 10 | 27 | 27 | 27 | 12.5 | .111 |
| 0101 18 82 | 18 | M22X1.5 | 10 | 27 | 30 | 29.5 | 12.5 | .129 |
| 0101 18 83 | 18 | M24X1.5 | 11 | 30 | 30 | 29.5 | 13 | .142 |

WARNING These products can expose you to chemicals including LEAD which is known to the state of California to cause cancer and birth defects or other reproductive harm. For more information go to www.P65Warnings.ca.gov.



[Click here for CADs, Product Specifications or to Configure Parts Online](#)

- A
- B
- C
- D
- E
- F
- G
- H
- I
- J
- K
- L
- M
- N
- O

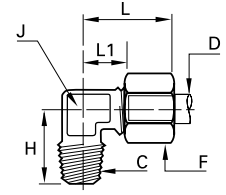
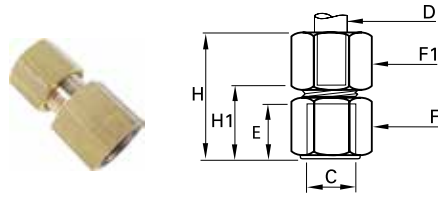

0114 Female Connector BSPP

| PART NO. | OD | C | E | F | F1 | H MAX | H1 | KG |
|------------|----|------|------|----|----|-------|------|------|
| 0114 04 10 | 4 | G1/8 | 9.5 | 14 | 10 | 26 | 16.5 | .020 |
| 0114 04 13 | 4 | G1/4 | 13.5 | 17 | 10 | 30 | 20.5 | .030 |
| 0114 05 10 | 5 | G1/8 | 9.5 | 14 | 12 | 28 | 17 | .023 |
| 0114 05 13 | 5 | G1/4 | 13.5 | 17 | 12 | 31 | 21 | .033 |
| 0114 06 10 | 6 | G1/8 | 9.5 | 14 | 13 | 28 | 17 | .025 |
| 0114 06 13 | 6 | G1/4 | 13.5 | 17 | 13 | 32 | 21 | .034 |
| 0114 06 17 | 6 | G3/8 | 14 | 22 | 13 | 32 | 21.5 | .051 |
| 0114 08 10 | 8 | G1/8 | 9.5 | 14 | 14 | 29 | 16.5 | .026 |
| 0114 08 13 | 8 | G1/4 | 13.5 | 17 | 14 | 33 | 20.5 | .036 |
| 0114 08 17 | 8 | G3/8 | 14 | 22 | 14 | 34 | 21 | .052 |
| 0114 10 13 | 10 | G1/4 | 13.5 | 17 | 19 | 37 | 21.5 | .052 |
| 0114 10 17 | 10 | G3/8 | 14 | 22 | 19 | 37 | 22 | .068 |
| 0114 10 21 | 10 | G1/2 | 18.5 | 27 | 19 | 42 | 26.5 | .099 |
| 0114 12 13 | 12 | G1/4 | 13.5 | 19 | 22 | 36 | 20.5 | .069 |
| 0114 12 17 | 12 | G3/8 | 14 | 22 | 22 | 37 | 22 | .078 |
| 0114 12 21 | 12 | G1/2 | 18.5 | 27 | 22 | 42 | 26.5 | .109 |
| 0114 14 13 | 14 | G1/4 | 13.5 | 22 | 24 | 36 | 18.5 | .085 |
| 0114 14 17 | 14 | G3/8 | 14 | 22 | 24 | 38 | 21 | .048 |
| 0114 14 21 | 14 | G1/2 | 18.5 | 27 | 24 | 43 | 25.5 | .113 |
| 0114 15 17 | 15 | G3/8 | 14 | 22 | 24 | 38 | 21 | .078 |
| 0114 15 21 | 15 | G1/2 | 18.5 | 27 | 24 | 43 | 25.5 | .109 |
| 0114 16 13 | 16 | G1/4 | 13.5 | 24 | 27 | 36 | 18 | .107 |
| 0114 16 17 | 16 | G3/8 | 14 | 24 | 27 | 38 | 20.5 | .106 |
| 0114 16 21 | 16 | G1/2 | 18.5 | 27 | 27 | 44 | 26 | .127 |
| 0114 18 17 | 18 | G3/8 | 14 | 27 | 30 | 39 | 19.5 | .140 |
| 0114 18 21 | 18 | G1/2 | 18.5 | 27 | 30 | 45 | 26 | .144 |
| 0114 18 27 | 18 | G3/4 | 19.5 | 32 | 30 | 46 | 27 | .165 |
| 0114 20 17 | 20 | G3/8 | 14 | 30 | 32 | 38 | 18 | .161 |
| 0114 20 21 | 20 | G1/2 | 18.5 | 30 | 32 | 44.5 | 24 | .173 |
| 0114 20 27 | 20 | G3/4 | 19.5 | 32 | 32 | 47 | 26.5 | .170 |
| 0114 22 27 | 22 | G3/4 | 19.5 | 32 | 36 | 48 | 26.5 | .204 |
| 0114 25 27 | 25 | G3/4 | 19.5 | 36 | 41 | 50.5 | 26 | .297 |

0109 Male Elbow BSPT

| PART NO. | OD | C | F | H | J | L MAX | L1 | KG |
|------------|----|------|----|------|----|-------|------|------|
| 0109 04 10 | 4 | R1/8 | 10 | 17 | 8 | 19 | 9.5 | .016 |
| 0109 04 13 | 4 | R1/4 | 10 | 20 | 10 | 19 | 11 | .026 |
| 0109 05 10 | 5 | R1/8 | 12 | 17.5 | 8 | 21 | 11 | .019 |
| 0109 05 13 | 5 | R1/4 | 12 | 21.5 | 10 | 22 | 12 | .028 |
| 0109 06 10 | 6 | R1/8 | 13 | 18 | 8 | 22 | 11 | .021 |
| 0109 06 13 | 6 | R1/4 | 13 | 21.5 | 10 | 22 | 12 | .031 |
| 0109 08 10 | 8 | R1/8 | 14 | 18.5 | 10 | 28 | 15 | .028 |
| 0109 08 13 | 8 | R1/4 | 14 | 22 | 10 | 28 | 15 | .033 |
| 0109 08 17 | 8 | R3/8 | 14 | 24 | 12 | 28 | 15 | .044 |
| 0109 10 13 | 10 | R1/4 | 19 | 25 | 12 | 30 | 14.5 | .052 |
| 0109 10 17 | 10 | R3/8 | 19 | 25.5 | 12 | 30 | 14.5 | .060 |
| 0109 10 21 | 10 | R1/2 | 19 | 32 | 19 | 36 | 21 | .109 |
| 0109 12 13 | 12 | R1/4 | 22 | 26 | 15 | 30 | 15 | .074 |
| 0109 12 17 | 12 | R3/8 | 22 | 27 | 15 | 30 | 15 | .077 |
| 0109 12 21 | 12 | R1/2 | 22 | 32 | 19 | 36 | 21 | .116 |
| 0109 14 17 | 14 | R3/8 | 24 | 30 | 19 | 35 | 18 | .105 |
| 0109 14 21 | 14 | R1/2 | 24 | 32 | 19 | 35 | 18 | .112 |
| 0109 15 17 | 15 | R3/8 | 24 | 30 | 19 | 35 | 18 | .099 |
| 0109 15 21 | 15 | R1/2 | 24 | 32 | 19 | 35 | 18 | .106 |
| 0109 16 17 | 16 | R3/8 | 27 | 30 | 19 | 39 | 21 | .120 |
| 0109 16 21 | 16 | R1/2 | 27 | 33.5 | 19 | 39 | 21 | .130 |
| 0109 16 27 | 16 | R3/4 | 27 | 36.5 | 23 | 41 | 23 | .189 |
| 0109 18 21 | 18 | R1/2 | 30 | 35.5 | 23 | 41 | 21.5 | .182 |
| 0109 18 27 | 18 | R3/4 | 30 | 36.5 | 23 | 41 | 21.5 | .199 |
| 0109 20 21 | 20 | R1/2 | 32 | 36.5 | 23 | 42 | 21.5 | .181 |
| 0109 20 27 | 20 | R3/4 | 32 | 38 | 23 | 42 | 21.5 | .200 |
| 0109 22 27 | 22 | R3/4 | 36 | 40 | 27 | 50 | 30 | .288 |
| 0109 22 34 | 22 | R1 | 36 | 44 | 27 | 50 | 30 | .342 |
| 0109 25 34 | 25 | R1 | 41 | 44 | 27 | 54 | 30 | .367 |
| 0109 28 34 | 28 | R1 | 42 | 48 | 32 | 54 | 30 | .384 |

WARNING These products can expose you to chemicals including LEAD which is known to the state of California to cause cancer and birth defects or other reproductive harm. For more information go to www.P65Warnings.ca.gov.

[Click here for CADs, Product Specifications or to Configure Parts Online](#)

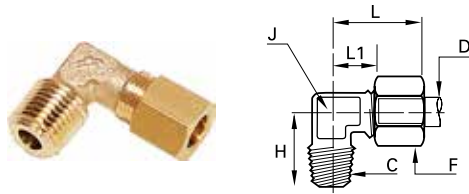

0109 Male Elbow NPT

| PART NO. | OD | C | F | H | J | L MAX | L1 | KG |
|------------|----|-----|----|------|----|-------|------|------|
| 0109 06 11 | 6 | 1/8 | 13 | 18 | 8 | 22 | 11 | .021 |
| 0109 06 14 | 6 | 1/4 | 13 | 21.5 | 10 | 22 | 12 | .030 |
| 0109 08 11 | 8 | 1/8 | 14 | 18.5 | 10 | 28 | 15 | .028 |
| 0109 08 14 | 8 | 1/4 | 14 | 22 | 10 | 28 | 15 | .033 |
| 0109 10 14 | 10 | 1/4 | 19 | 25 | 12 | 30 | 14.5 | .053 |

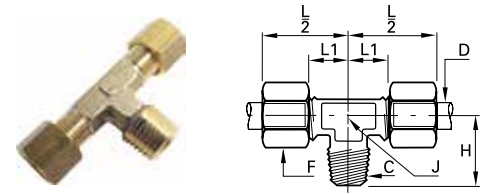

0108 Male Branch Tee Male BSPT

| PART NO. | OD | C | F | H | J | L1 | L2 | KG |
|------------|----|------|----|------|----|------|----|------|
| 0108 04 10 | 4 | R1/8 | 10 | 17 | 8 | 9.5 | 19 | .025 |
| 0108 05 10 | 5 | R1/8 | 12 | 17.5 | 8 | 11 | 21 | .017 |
| 0108 06 10 | 6 | R1/8 | 13 | 18 | 8 | 11 | 22 | .032 |
| 0108 06 13 | 6 | R1/4 | 13 | 21.5 | 10 | 16 | 27 | .047 |
| 0108 08 10 | 8 | R1/8 | 14 | 18.5 | 10 | 15 | 28 | .045 |
| 0108 08 13 | 8 | R1/4 | 14 | 22 | 10 | 15 | 28 | .050 |
| 0108 08 17 | 8 | R3/8 | 14 | 24 | 12 | 15 | 28 | .061 |
| 0108 10 13 | 10 | R1/4 | 19 | 25 | 12 | 14.5 | 30 | .084 |
| 0108 10 17 | 10 | R3/8 | 19 | 25.5 | 12 | 14.5 | 30 | .090 |
| 0108 12 13 | 12 | R1/4 | 22 | 26 | 15 | 15 | 30 | .116 |
| 0108 12 17 | 12 | R3/8 | 22 | 27 | 15 | 15 | 30 | .117 |
| 0108 14 17 | 14 | R3/8 | 24 | 30 | 19 | 18 | 35 | .153 |
| 0108 14 21 | 14 | R1/2 | 24 | 32 | 19 | 18 | 35 | .168 |
| 0108 16 17 | 16 | R3/8 | 27 | 30 | 19 | 21 | 39 | .190 |
| 0108 16 21 | 16 | R1/2 | 27 | 33.5 | 19 | 21 | 39 | .203 |
| 0108 18 21 | 18 | R1/2 | 30 | 35.5 | 23 | 21.5 | 41 | .265 |
| 0108 18 27 | 18 | R3/4 | 30 | 36.5 | 23 | 21.5 | 41 | .292 |
| 0108 20 27 | 20 | R3/4 | 32 | 38 | 23 | 21.5 | 42 | .298 |
| 0108 22 27 | 22 | R3/4 | 36 | 40 | 27 | 29 | 50 | .435 |
| 0108 22 34 | 22 | R1 | 36 | 44 | 27 | 29 | 50 | .466 |

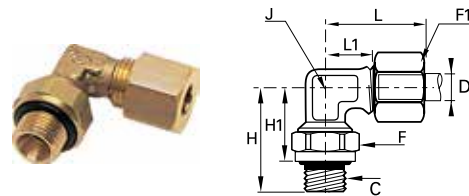

0199 Adjustable Male Elbow BSPP

| PART NO. | OD | C | F | F1 | H | H1 | H1 MAX | J | L MAX | L1 | KG |
|------------|----|------|----|----|------|------|--------|----|-------|------|------|
| 0199 04 10 | 4 | G1/8 | 14 | 10 | 23 | 16 | 17 | 8 | 19 | 9.5 | .023 |
| 0199 04 13 | 4 | G1/4 | 19 | 10 | 30.5 | 22 | 23.5 | 10 | 19 | 11 | .043 |
| 0199 06 10 | 6 | G1/8 | 14 | 13 | 23 | 16 | 17 | 8 | 22 | 11 | .027 |
| 0199 06 13 | 6 | G1/4 | 19 | 13 | 30.5 | 22 | 23.5 | 10 | 22 | 12 | .047 |
| 0199 08 10 | 8 | G1/8 | 14 | 14 | 24 | 17 | 18 | 10 | 28 | 15 | .033 |
| 0199 08 13 | 8 | G1/4 | 19 | 14 | 30.5 | 22 | 23.5 | 10 | 28 | 15 | .051 |
| 0199 08 17 | 8 | G3/8 | 22 | 14 | 33.5 | 24 | 25.5 | 12 | 28 | 15 | .065 |
| 0199 10 13 | 10 | G1/4 | 19 | 19 | 31 | 22.5 | 24 | 12 | 30 | 14.5 | .068 |
| 0199 10 17 | 10 | G3/8 | 22 | 19 | 33.5 | 24 | 25.5 | 12 | 30 | 14.5 | .079 |
| 0199 10 21 | 10 | G1/2 | 27 | 19 | 40 | 29.5 | 31 | 19 | 37 | 22 | .138 |
| 0199 14 17 | 14 | G3/8 | 22 | 24 | 35.5 | 26 | 27.5 | 19 | 35 | 18 | .119 |
| 0199 14 21 | 14 | G1/2 | 27 | 24 | 40 | 29.5 | 31 | 19 | 35 | 18 | .141 |
| 0199 18 21 | 18 | G1/2 | 27 | 30 | 40 | 29 | 30.5 | 23 | 41 | 21.5 | .187 |
| 0199 18 27 | 18 | G3/4 | 32 | 30 | 43.5 | 32 | 33.5 | 23 | 41 | 21.5 | .222 |
| 0199 22 27 | 22 | G3/4 | 32 | 36 | 45.5 | 34 | 36 | 32 | 51 | 31 | .382 |
| 0199 22 34 | 22 | G1 | 41 | 36 | 54 | 40.5 | 43 | 32 | 51 | 31 | .408 |
| 0199 28 34 | 28 | G1 | 41 | 42 | 54 | 40.5 | 43 | 32 | 54 | 30 | .420 |

The body will orientate for positioning purposes

WARNING These products can expose you to chemicals including LEAD which is known to the state of California to cause cancer and birth defects or other reproductive harm. For more information go to www.P65Warnings.ca.gov.



Click here for CADs, Product Specifications or to Configure Parts Online

- A
- B
- C
- D
- E
- F
- G
- H
- I
- J
- K
- L
- M
- N
- O

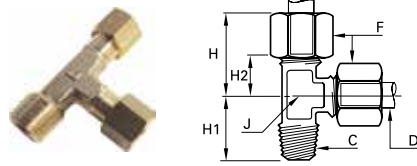

0103 Male Run Tee BSPT

| PART NO. | OD | C | F | H MAX | H1 | H2 | J | KG |
|------------|----|------|----|----------|------|------|----|------|
| 0103 04 10 | 4 | R1/8 | 10 | 19 | 17 | 9.5 | 8 | .025 |
| 0103 06 10 | 6 | R1/8 | 13 | 22 | 18 | 11 | 8 | .033 |
| 0103 06 13 | 6 | R1/4 | 13 | 27 | 21.5 | 16 | 10 | .048 |
| 0103 08 13 | 8 | R1/4 | 14 | 28 | 22 | 15 | 10 | .050 |
| 0103 08 17 | 8 | R3/8 | 14 | 28 | 24 | 15 | 12 | .061 |
| 0103 10 13 | 10 | R1/4 | 19 | 30 | 25 | 14.5 | 12 | .084 |
| 0103 12 13 | 12 | R1/4 | 22 | 30 | 26 | 15 | 15 | .114 |
| 0103 14 17 | 14 | R3/8 | 24 | 35 | 30 | 18 | 19 | .161 |
| 0103 14 21 | 14 | R1/2 | 24 | 35 | 32 | 18 | 19 | .169 |
| 0103 15 17 | 15 | R3/8 | 24 | 35 | 30 | 18 | 19 | .148 |
| 0103 15 21 | 15 | R1/2 | 24 | 35 | 32 | 18 | 19 | .158 |
| 0103 16 17 | 16 | R3/8 | 27 | 39 | 30 | 21 | 19 | .192 |
| 0103 18 21 | 18 | R1/2 | 30 | 41 | 35.5 | 21.5 | 23 | .269 |
| 0103 18 27 | 18 | R3/4 | 30 | 41 | 36.5 | 21.5 | 23 | .282 |
| 0103 20 27 | 20 | R3/4 | 32 | 42 | 38 | 21.5 | 23 | .298 |
| 0103 22 27 | 22 | R3/4 | 36 | 50 | 40 | 29 | 27 | .435 |
| 0108 22 34 | 22 | R1 | 36 | 44 | 27 | 29 | 50 | .466 |

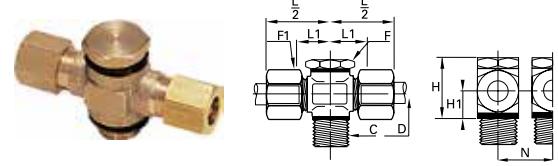

0119 Double Banjo with Captive Sealing Washer Male BSPP

| PART NO. | OD | C | F | F1 | H | H1 | L1 | L2 | N | KG |
|------------|----|------|----|----|----|------|------|------|------|------|
| 0119 06 10 | 6 | G1/8 | 14 | 13 | 24 | 9.5 | 14.5 | 25 | 17.5 | .056 |
| 0119 08 13 | 8 | G1/4 | 17 | 14 | 25 | 10 | 15.5 | 28 | 21 | .074 |
| 0119 08 17 | 8 | G3/8 | 22 | 14 | 32 | 13 | 18 | 30.5 | 26.5 | .140 |
| 0119 10 13 | 10 | G1/4 | 17 | 19 | 31 | 13 | 19 | 34 | 23 | .156 |
| 0119 10 17 | 10 | G3/8 | 22 | 19 | 32 | 13 | 19 | 34 | 26.5 | .165 |
| 0119 12 13 | 12 | G1/4 | 17 | 22 | 34 | 14.5 | 19 | 34 | 23 | .180 |
| 0119 12 17 | 12 | G3/8 | 22 | 22 | 35 | 14.5 | 19 | 34 | 26.5 | .182 |
| 0119 14 13 | 14 | G1/4 | 17 | 24 | 37 | 16 | 20.5 | 37.5 | 28 | .246 |
| 0119 14 17 | 14 | G3/8 | 22 | 24 | 38 | 16 | 20.5 | 37.5 | 28 | .247 |
| 0119 14 21 | 14 | G1/2 | 27 | 24 | 40 | 16 | 20.5 | 38 | 32.5 | .219 |

Zinc plated steel with NBR seal. Thread with pre-assembled polymer washer

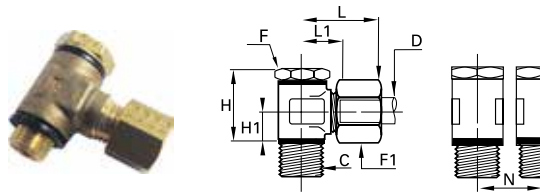

0118 Single Banjo with Captive Sealing Washer Male BSPP

| PART NO. | OD | C | F | F1 | H | H1 | L1 MAX | L1 | N | KG |
|------------|----|------|----|----|----|------|-----------|------|------|------|
| 0118 05 10 | 5 | G1/8 | 14 | 12 | 24 | 9.5 | 25 | 14.5 | 17.5 | .041 |
| 0118 05 13 | 5 | G1/4 | 17 | 12 | 25 | 10 | 26 | 16 | 21 | .058 |
| 0118 14 13 | 14 | G1/4 | 17 | 24 | 37 | 16 | 37 | 20.5 | 28 | .154 |
| 0118 14 17 | 14 | G3/8 | 22 | 24 | 38 | 16 | 37 | 20.5 | 28 | .195 |
| 0118 14 21 | 14 | G1/2 | 27 | 24 | 40 | 16 | 38 | 20.5 | 32.5 | .208 |
| 0118 15 17 | 15 | G3/8 | 22 | 24 | 38 | 16 | 37 | 20.5 | 28 | .190 |
| 0118 15 21 | 15 | G1/2 | 27 | 24 | 40 | 16 | 38 | 20.5 | 32.5 | .198 |
| 0118 16 21 | 16 | G1/2 | 27 | 27 | 42 | 16 | 38 | 21 | 32.5 | .221 |
| 0118 18 21 | 18 | G1/2 | 27 | 30 | 46 | 19.5 | 43 | 24.5 | 36 | .366 |
| 0118 20 27 | 20 | G3/4 | 32 | 32 | 49 | 20 | 44 | 24.5 | 39 | .403 |
| 0118 22 27 | 22 | G3/4 | 32 | 36 | 53 | 22 | 45 | 24.5 | 39 | .459 |

With pre-assembled captive polymer sealing washer

WARNING These products can expose you to chemicals including LEAD which is known to the state of California to cause cancer and birth defects or other reproductive harm. For more information go to www.P65Warnings.ca.gov.

[Click here for CADs, Product Specifications or to Configure Parts Online](#)

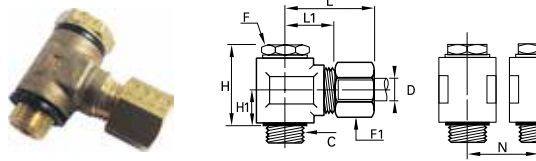

0118 Single Banjo with Bi-Material Seal Male BSPP

| PART NO. | OD | C | F | F1 | H | H1 | L1 MAX | L1 | N | KG |
|---------------|----|------|----|----|------|------|--------|------|------|------|
| 0118 04 10 39 | 4 | G1/8 | 14 | 10 | 23 | 9.5 | 24 | 14.5 | 17.5 | .038 |
| 0118 05 10 39 | 5 | G1/8 | 14 | 12 | 23 | 9.5 | 25 | 14.5 | 17.5 | .041 |
| 0118 05 13 39 | 5 | G1/4 | 17 | 12 | 24 | 10 | 26 | 16 | 21 | .064 |
| 0118 06 10 39 | 6 | G1/8 | 14 | 13 | 23 | 9.5 | 25 | 14.5 | 17.5 | .042 |
| 0118 06 13 39 | 6 | G1/4 | 17 | 13 | 24 | 10 | 26 | 16 | 21 | .057 |
| 0118 08 10 39 | 8 | G1/8 | 14 | 14 | 23 | 9.5 | 28 | 15.5 | 17.5 | .055 |
| 0118 08 13 39 | 8 | G1/4 | 17 | 14 | 24 | 10 | 28 | 15.5 | 21 | .058 |
| 0118 08 17 39 | 8 | G3/8 | 22 | 14 | 31.5 | 13.5 | 30 | 18 | 26.5 | .113 |
| 0118 10 13 39 | 10 | G1/4 | 17 | 19 | 30 | 13 | 34 | 19 | 23 | .118 |
| 0118 10 17 39 | 10 | G3/8 | 22 | 19 | 31.5 | 13.5 | 34 | 19 | 26.5 | .128 |
| 0118 12 13 39 | 12 | G1/4 | 17 | 22 | 33 | 14.5 | 34 | 19 | 23 | .128 |
| 0118 12 17 39 | 12 | G3/8 | 22 | 22 | 34.5 | 15 | 34 | 19 | 26.5 | .140 |
| 0118 14 13 39 | 14 | G1/4 | 17 | 24 | 36 | 16 | 37 | 20.5 | 28 | .189 |
| 0118 14 17 39 | 14 | G3/8 | 22 | 24 | 37.5 | 16.5 | 37 | 20.5 | 28 | .198 |
| 0118 14 21 39 | 14 | G1/2 | 27 | 24 | 39 | 16.5 | 38 | 20.5 | 32.5 | .205 |
| 0118 15 17 39 | 15 | G3/8 | 22 | 24 | 37.5 | 16.5 | 37 | 20.5 | 28 | .389 |
| 0118 15 21 39 | 15 | G1/2 | 27 | 24 | 40 | 16.5 | 38 | 20.5 | 32.5 | .202 |
| 0118 16 21 39 | 16 | G1/2 | 27 | 27 | 40 | 16.5 | 38 | 21 | 32.5 | .225 |
| 0118 18 21 39 | 18 | G1/2 | 27 | 30 | 47 | 20 | 43 | 24.5 | 36 | .369 |
| 0118 20 27 39 | 20 | G3/4 | 32 | 32 | 50 | 20.5 | 44 | 24.5 | 39 | .394 |
| 0118 22 27 39 | 22 | G3/4 | 32 | 36 | 54 | 22.5 | 45 | 24.5 | 39 | .462 |

Zinc plated steel with NBR seal

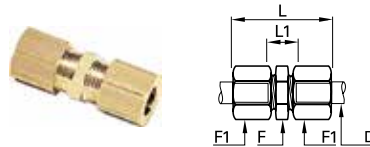

0106 Equal Tube-to-Tube Connector

| PART NO. | OD | F | F1 | L MAX | L1 | KG |
|------------|----|----|----|-------|----|------|
| 0106 04 00 | 4 | 10 | 10 | 28 | 10 | .016 |
| 0106 05 00 | 5 | 11 | 12 | 31 | 11 | .023 |
| 0106 06 00 | 6 | 11 | 13 | 32 | 11 | .026 |
| 0106 08 00 | 8 | 13 | 14 | 36 | 10 | .031 |
| 0106 10 00 | 10 | 17 | 19 | 42 | 13 | .070 |
| 0106 12 00 | 12 | 19 | 22 | 42 | 13 | .092 |
| 0106 14 00 | 14 | 22 | 24 | 45 | 11 | .104 |
| 0106 15 00 | 15 | 22 | 24 | 45 | 11 | .097 |
| 0106 16 00 | 16 | 24 | 27 | 48 | 13 | .141 |
| 0106 18 00 | 18 | 27 | 30 | 53 | 14 | .186 |
| 0106 20 00 | 20 | 30 | 32 | 56 | 14 | .211 |
| 0106 22 00 | 22 | 32 | 36 | 60 | 14 | .283 |
| 0106 25 00 | 25 | 36 | 41 | 64 | 14 | .396 |
| 0106 28 00 | 28 | 41 | 42 | 64 | 14 | .399 |

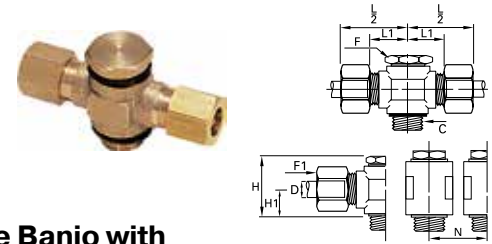

0119 Double Banjo with Bi-Material Seal Male BSPP

| PART NO. | OD | C | F | F1 | H | H1 | L1 | L2 | N | KG |
|---------------|----|------|----|----|------|------|------|----|------|------|
| 0119 04 10 39 | 4 | G1/8 | 14 | 10 | 23 | 9.5 | 14.5 | 24 | 17.5 | .050 |
| 0119 05 10 39 | 5 | G1/8 | 14 | 12 | 23 | 9.5 | 14.5 | 25 | 17.5 | .049 |
| 0119 05 13 39 | 5 | G1/4 | 17 | 12 | 24 | 10 | 126 | 26 | 21 | .072 |
| 0119 06 10 39 | 6 | G1/8 | 14 | 13 | 23 | 9.5 | 14.5 | 25 | 17.5 | .056 |
| 0119 06 13 39 | 6 | G1/4 | 17 | 13 | 24 | 10 | 16 | 26 | 21 | .071 |
| 0119 08 10 39 | 8 | G1/8 | 14 | 14 | 23 | 9.5 | 15.5 | 28 | 17.5 | .072 |
| 0119 08 13 39 | 8 | G1/4 | 17 | 14 | 24 | 10 | 15.5 | 28 | 21 | .080 |
| 0119 08 17 39 | 8 | G3/8 | 22 | 14 | 31.5 | 13.5 | 18 | 30 | 26.5 | .118 |
| 0119 10 13 39 | 10 | G1/4 | 17 | 19 | 30 | 13 | 19 | 34 | 23 | .156 |
| 0119 10 17 39 | 10 | G3/8 | 22 | 19 | 31.5 | 13.5 | 19 | 34 | 26.5 | .167 |
| 0119 12 13 39 | 12 | G1/4 | 17 | 22 | 33 | 14.5 | 19 | 34 | 23 | .180 |
| 0119 12 17 39 | 12 | G3/8 | 22 | 22 | 34.5 | 15 | 19 | 34 | 26.5 | .183 |
| 0119 14 13 39 | 14 | G1/4 | 17 | 24 | 36 | 16 | 20.5 | 37 | 28 | .248 |
| 0119 14 17 39 | 14 | G3/8 | 22 | 24 | 37.5 | 16.5 | 20.5 | 37 | 28 | .247 |
| 0119 14 21 39 | 14 | G1/2 | 27 | 24 | 39 | 16.5 | 20.5 | 38 | 32.5 | .262 |
| 0119 15 17 39 | 15 | G3/8 | 22 | 24 | 37.5 | 16.5 | 20.5 | 37 | 28 | .246 |
| 0119 15 21 39 | 15 | G1/2 | 27 | 24 | 40 | 16.5 | 20.5 | 38 | 32.5 | .251 |
| 0119 18 21 39 | 18 | G1/2 | 27 | 30 | 47 | 20 | 24.5 | 43 | 36 | .469 |
| 0119 20 27 39 | 20 | G3/4 | 32 | 32 | 50 | 20.5 | 24.5 | 44 | 39 | .638 |
| 0119 22 27 39 | 22 | G3/4 | 32 | 36 | 54 | 22.5 | 24.5 | 45 | 39 | .610 |

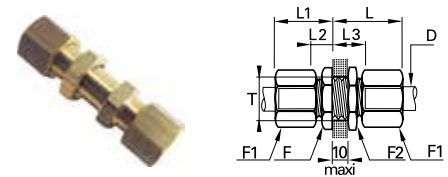

0116 Bulkhead Union

| PART NO. | OD | F | F1 | F2 | L MAX | L1 MAX | L2 | L3 | OT MIN | KG |
|------------|----|----|----|----|-------|--------|------|------|--------|------|
| 0116 04 00 | 4 | 10 | 10 | 13 | 27 | 17 | 7 | 17 | 8.3 | .024 |
| 0116 05 00 | 5 | 13 | 12 | 14 | 28 | 18 | 7.5 | 17.5 | 10.3 | .035 |
| 0116 06 00 | 6 | 13 | 13 | 14 | 28 | 19 | 7.5 | 17.5 | 10.3 | .037 |
| 0116 08 00 | 8 | 14 | 14 | 17 | 29 | 20 | 7 | 17 | 12.3 | .045 |
| 0116 10 00 | 10 | 19 | 19 | 22 | 33 | 25 | 9 | 19 | 16.5 | .101 |
| 0116 12 00 | 12 | 22 | 22 | 22 | 33 | 25 | 9 | 19 | 18.5 | .121 |
| 0116 14 00 | 14 | 24 | 24 | 24 | 35 | 25 | 8 | 18 | 20.5 | .145 |
| 0116 15 00 | 15 | 24 | 24 | 24 | 35 | 25 | 8 | 18 | 20.5 | .134 |
| 0116 16 00 | 16 | 27 | 27 | 27 | 36 | 28 | 9.5 | 19.5 | 22.5 | .189 |
| 0116 18 00 | 18 | 27 | 30 | 30 | 40 | 30 | 10.5 | 20.5 | 24.5 | .237 |
| 0116 20 00 | 20 | 32 | 30 | 32 | 41 | 31 | 11 | 21 | 27.5 | .274 |
| 0116 22 00 | 22 | 36 | 36 | 36 | 42 | 32 | 11 | 21 | 30.5 | .372 |
| 0116 25 00 | 25 | 36 | 41 | 38 | 46 | 36 | 11 | 21 | 33.5 | .469 |

WARNING These products can expose you to chemicals including LEAD which is known to the state of California to cause cancer and birth defects or other reproductive harm. For more information go to www.P65Warnings.ca.gov.



[Click here for CADs, Product Specifications or to Configure Parts Online](#)

- A
- B
- C
- D
- E
- F
- G
- H
- I
- J
- K
- L
- M
- N
- O

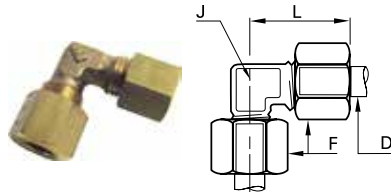

0102 Union Elbow

| PART NO. | OD | F | J | L MAX | KG |
|------------|----|----|----|-------|------|
| 0102 04 00 | 4 | 10 | 5 | 19 | .016 |
| 0102 05 00 | 5 | 12 | 8 | 21 | .024 |
| 0102 06 00 | 6 | 13 | 8 | 22 | .027 |
| 0102 08 00 | 8 | 14 | 10 | 28 | .038 |
| 0102 10 00 | 10 | 19 | 12 | 30 | .073 |
| 0102 12 00 | 12 | 22 | 15 | 30 | .098 |
| 0102 14 00 | 14 | 24 | 19 | 35 | .133 |
| 0102 15 00 | 15 | 24 | 19 | 35 | .122 |
| 0102 16 00 | 16 | 27 | 19 | 39 | .164 |
| 0102 18 00 | 18 | 30 | 23 | 41 | .231 |
| 0102 20 00 | 20 | 32 | 23 | 42 | .233 |
| 0102 22 00 | 22 | 36 | 27 | 50 | .371 |
| 0102 25 00 | 25 | 41 | 27 | 54 | .446 |
| 0102 28 00 | 28 | 42 | 32 | 54.5 | .478 |



0107 Union Cross

| PART NO. | OD | F | H | J | L2 | KG |
|------------|----|----|------|----|----|------|
| 0107 04 00 | 4 | 10 | 9.5 | 8 | 19 | .035 |
| 0107 05 00 | 5 | 12 | 11 | 8 | 21 | .047 |
| 0107 06 00 | 6 | 13 | 11 | 8 | 22 | .052 |
| 0107 08 00 | 8 | 14 | 15 | 11 | 28 | .073 |
| 0107 10 00 | 10 | 19 | 14.5 | 14 | 30 | .142 |
| 0107 12 00 | 12 | 22 | 15 | 15 | 35 | .096 |
| 0107 14 00 | 14 | 24 | 18 | 20 | 35 | .246 |
| 0107 15 00 | 15 | 24 | 18 | 20 | 35 | .227 |
| 0107 16 00 | 16 | 27 | 21 | 20 | 39 | .312 |
| 0107 18 00 | 18 | 30 | 21.5 | 25 | 41 | .426 |
| 0107 20 00 | 20 | 32 | 21.5 | 25 | 42 | .429 |
| 0107 22 00 | 22 | 36 | 29 | 27 | 50 | .676 |
| 0107 25 00 | 25 | 41 | 29 | 27 | 50 | .819 |

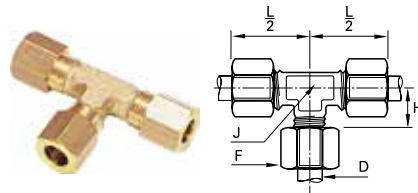

0104 Union Tee

| PART NO. | OD | F | H | J | L 2 | KG |
|------------|----|----|------|----|-----|------|
| 0104 04 00 | 4 | 10 | 9.5 | 8 | 19 | .028 |
| 0104 05 00 | 5 | 12 | 11 | 8 | 21 | .036 |
| 0104 06 00 | 6 | 13 | 11 | 8 | 22 | .040 |
| 0104 08 00 | 8 | 14 | 15 | 10 | 28 | .055 |
| 0104 10 00 | 10 | 19 | 14.5 | 12 | 30 | .105 |
| 0104 12 00 | 12 | 22 | 15 | 15 | 30 | .142 |
| 0104 14 00 | 14 | 24 | 18 | 19 | 35 | .190 |
| 0104 15 00 | 15 | 24 | 18 | 19 | 35 | .175 |
| 0104 16 00 | 16 | 27 | 21 | 19 | 39 | .239 |
| 0104 18 00 | 18 | 30 | 21.5 | 23 | 41 | .330 |
| 0104 20 00 | 20 | 32 | 21.5 | 23 | 42 | .330 |
| 0104 22 00 | 22 | 36 | 29 | 27 | 50 | .518 |
| 0104 25 00 | 25 | 41 | 29 | 27 | 54 | .630 |

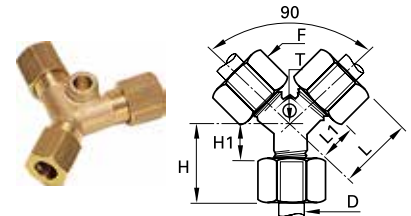

0142 Union Y with Mounting Boss

| PART NO. | OD | F | H MAX | H1 | L MAX | L1 | OT | KG |
|------------|----|----|-------|-----|-------|------|------|------|
| 0142 04 00 | 4 | 10 | 16.5 | 7 | 26.5 | 17 | 4.2 | .032 |
| 0142 06 00 | 6 | 13 | 19.5 | 8.5 | 28 | 17 | 4.2 | .049 |
| 0142 08 00 | 8 | 14 | 21 | 8 | 30 | 17 | 6.2 | .061 |
| 0142 10 00 | 10 | 19 | 24.5 | 9 | 37.5 | 22 | 6.2 | .128 |
| 0142 12 00 | 12 | 22 | 26 | 11 | 38 | 23 | 6.2 | .110 |
| 0142 14 00 | 14 | 24 | 28 | 11 | 41.5 | 24.5 | 6.2 | .201 |
| 0142 15 00 | 15 | 24 | 28 | 11 | 41.5 | 24.5 | 6.2 | .204 |
| 0142 16 00 | 16 | 27 | 30 | 12 | 43 | 25 | 6.2 | .252 |
| 0142 18 00 | 18 | 30 | 31.5 | 12 | 50.5 | 31 | 10.2 | .220 |
| 0142 25 00 | 25 | 41 | 39 | 14 | 59 | 34 | 10.2 | .728 |

WARNING These products can expose you to chemicals including LEAD which is known to the state of California to cause cancer and birth defects or other reproductive harm. For more information go to www.P65Warnings.ca.gov.



[Click here for CADs, Product Specifications or to Configure Parts Online](#)

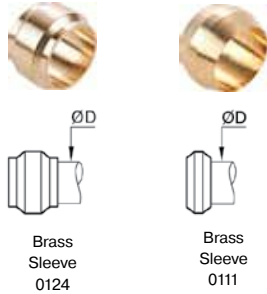

0124 Suffix 40, 0111 Sleeves

| OD MM | PART NO. | WT | PART NO. | WT |
|-------|------------|------|------------|------|
| 4 | 0124 04 40 | .001 | 0111 04 00 | .001 |
| 5 | 0124 05 40 | .001 | 0111 05 00 | .001 |
| 6 | 0124 06 40 | .001 | 0111 06 00 | .001 |
| 8 | 0124 08 40 | .002 | 0111 08 00 | .002 |
| 10 | 0124 10 40 | .003 | 0111 10 00 | .002 |
| 12 | 0124 12 40 | .004 | 0111 12 00 | .003 |
| 14 | 0124 14 40 | .004 | 0111 14 00 | .003 |
| 15 | 0124 15 40 | .004 | 0111 15 00 | .003 |
| 16 | 0124 16 40 | .006 | 0111 16 00 | .004 |
| 18 | 0124 18 40 | .007 | - | - |
| 20 | 0124 20 40 | .009 | - | - |
| 22 | 0124 22 40 | .012 | - | - |
| 25 | 0124 25 40 | .017 | - | - |
| 28 | 0124 28 40 | .017 | - | - |

Technical Specifications of Nuts

Tightening Torque

- Maximum kg = tightening torque for nut 0110 and sleeve 0124 on copper, brass or steel tube

| OD MM | MAX KG. TORQUE |
|-------|----------------|
| 4 | .7 |
| 5 | .7 |
| 6 | 1.5 |
| 8 | 1.5 |
| 10 | 1.8 |
| 12 | 3 |
| 14 | 3.5 |
| 15 | 4 |
| 16 | 5 |
| 18 | 6 |
| 20 | 6 |
| 22 | 7 |
| 25 | 8 |
| 28 | 9 |

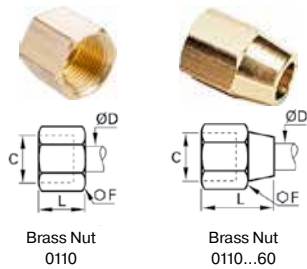

0110, 0110 Suffix 60 Nuts

| OD MM | C | PART NO. | WT | PART NO. | WT |
|-------|---------|------------|------|---------------|------|
| 4 | M8X1 | 0110 04 00 | .005 | 0110 04 00 60 | .006 |
| 5 | M10X1 | 0110 05 00 | .006 | 0110 05 00 60 | .009 |
| 6 | M10X1 | 0110 06 00 | .008 | 0110 06 00 60 | .011 |
| 8 | M12X1 | 0110 08 00 | .008 | 0110 08 00 60 | .012 |
| 10 | M16X1.5 | 0110 10 00 | .019 | 0110 10 00 60 | .027 |
| 12 | M18X1.5 | 0110 12 00 | .026 | 0110 12 00 60 | .041 |
| 14 | M20X1.5 | 0110 14 00 | .029 | - | - |
| 15 | M20X1.5 | 0110 15 00 | .028 | 0110 15 00 60 | .050 |
| 16 | M22X1.5 | 0110 16 00 | .043 | 0110 16 00 60 | .072 |
| 18 | M24X1.5 | 0110 18 00 | .059 | - | - |
| 20 | M27X1.5 | 0110 20 00 | .057 | - | - |
| 22 | M30X1.5 | 0110 22 00 | .079 | - | - |
| 25 | M33X1.5 | 0110 25 00 | .121 | - | - |
| 28 | M36X1.5 | 0110 28 00 | .109 | - | - |

WARNING These products can expose you to chemicals including LEAD which is known to the state of California to cause cancer and birth defects or other reproductive harm. For more information go to www.P65Warnings.ca.gov.



Click here for CADs, Product Specifications or to Configure Parts Online

Complementary Brass Fittings – Assembly Configuration

The table and information given below illustrate the large number of options available with Parker Legris brass compression fittings. To these must be added the advantages specific to the original Parker Legris reducer shown on the previous page.



| 0110 BRASS | | | 0110..60 BRASS | | 0110..40 STEEL | 0110..70* POLYMER |
|--|---|-----------------------------|--|--|--|--|
| | 0124 BRASS | 0111 BNA** BRAS | | 0111 BNA** BRAS | 01 24...40 STEEL | |
| No olive required to assemble the plug | | | | | | No olive required to assemble the tube |
| Brass plug: 0126 | Copper, cold-rolled brass, polymer tube and barb connectors 0122 and 0165 | Coiled annealed copper tube | Cold-rolled copper tube for vibration and side loading, etc. | Coiled annealed copper tube for vibration and side loading, etc. | Steel or copper tube: low/medium hydraulic pressure, lubricate before assembly | Polymer tube |
| | | | | | | |

*Assembly specifications for nut-olive 0110 ..70

This part functions as both olive and nut for flexible polymer tube assemblies:

1. Hand tighten the polymer nut-olive a few turns onto the body of the fitting; the knurling makes this easier.
2. Then introduce the polymer tube and push home into the body of the fitting.
3. Continue manually tightening the polymer nut-olive.
4. Finish tightening using a spanner until the nut body disengages and turns freely, which acts as a torque limiter.

N.B.: To avoid damaging the threads, do not insert the tube before hand tightening the nut-olive into the body of the fitting.

**Bureau de Normalisation de l'Automobile (French Automotive Bureau of Standards)

Recommended Tightening Torque

Tightening torque in daN.m = maximum tightening torque of a 0110 nut and 0124 olive with copper, brass or steel tube.

Nut 0110 and 0110..40

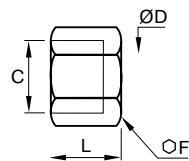

Nut 0110..60

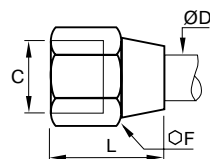

| Ø D (MM) | F 0110 | F 0110..60 | MAX. DAN.M COPPER OR BRASS | F 0110..40 | MAX. DAN.M STEEL |
|----------|--------|------------|----------------------------|------------|------------------|
| 4 | 10 | 11 | .7 | 10 | 1.5 |
| 5 | 12 | 12 | .7 | 12 | 1.5 |
| 6 | 13 | 12 | 1.5 | 13 | 2.5 |
| 8 | 14 | 16 | 1.5 | 14 | 2.5 |
| 10 | 19 | 20 | 1.8 | 19 | 3 |
| 12 | 22 | 22 | 3 | 22 | 4.5 |
| 14 | 24 | 24 | 3.5 | 24 | 5.5 |
| 15 | 24 | 24 | 4 | 24 | 6 |
| 16 | 27 | 27 | 5 | 27 | 7 |
| 18 | 30 | 30 | 6 | 30 | 9 |
| 20 | 32 | 32 | 6 | 32 | 10 |
| 22 | 36 | 36 | 7 | 36 | 12 |
| 25 | 41 | 42 | 8 | 41 | 13 |
| 28 | 42 | | 9 | | |

WARNING These products can expose you to chemicals including LEAD which is known to the state of California to cause cancer and birth defects or other reproductive harm. For more information go to www.P65Warnings.ca.gov.

Click here for CADs, Product Specifications or to Configure Parts Online

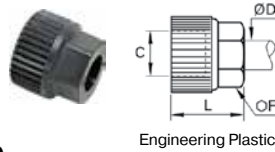

Engineering Plastic

0110 Suffix 70 Nut Sleeve

| PART NO. | OD MM | C | F MM | L MM | WT |
|---------------|-------|---------|------|------|------|
| 0110 04 00 70 | 4 | M8X1 | 8 | 13 | .001 |
| 0110 06 00 70 | 6 | M10X1 | 11 | 15 | .002 |
| 0110 08 00 70 | 8 | M12X1 | 13 | 16 | .002 |
| 0110 10 00 70 | 10 | M16X1.5 | 17 | 19 | .004 |
| 0110 12 00 70 | 12 | M18X1.5 | 19 | 19 | .005 |
| 0110 14 00 70 | 14 | M20X1.5 | 22 | 20 | .007 |
| 0110 16 00 70 | 16 | M22X1.5 | 24 | 21 | .009 |

Plastic nut-sleeve should not be used on metal tubes.

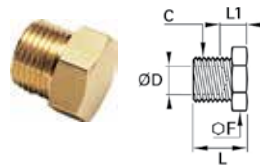

0125 End Plug Metric

| PART NO. | OD MM | C | F MM | L MM | L1 MM | WT |
|------------|-------|---------|------|------|-------|------|
| 0125 06 00 | 6 | M10X1 | 11 | 13.5 | 9.5 | .009 |
| 0125 08 00 | 8 | M12X1 | 14 | 14 | 9 | .012 |
| 0125 10 00 | 10 | M16X1.5 | 17 | 18 | 11 | .025 |

The plug enables unused tubes to be blanked off. The male thread on the plug has the same pitch as the female thread on the nut of a standard Legris fitting. Therefore, the plug screwed into the nut blanks off the tube.

To reopen the passage, simply unscrew the plug and fit the required connector. No further treatment of the tube is required.

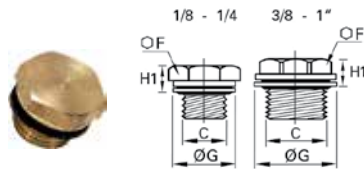

Brass with Bi-Material Seal

0220 Male Plug BSPP

| PART NUMBER | C BSPP | F MM | G MM | H1 MM | WT |
|---------------|--------|------|------|-------|------|
| 0220 10 00 39 | G 1/8 | 14 | 14 | 6.5 | .005 |
| 0220 13 00 39 | G 1/4 | 17 | 17 | 6.5 | .016 |
| 0220 17 00 39 | G 3/8 | 17 | 22 | 8 | .021 |
| 0220 21 00 39 | G 1/2 | 22 | 26 | 9 | .045 |
| 0220 27 00 39 | G 3/4 | 22 | 32 | 10 | .053 |
| 0220 34 00 39 | G 1 | 27 | 39.5 | 10.5 | .067 |

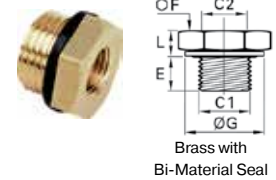

Brass with Bi-Material Seal

0168 Reducer Male To Female BSPP

| PART NO. | C1 BSPP | C2 BSPP | E MM | F MM | G MM | L MM | WT |
|---------------|---------|---------|------|------|------|------|------|
| 0168 10 19 39 | G 1/8 | M5X.8 | 8 | 14 | 14 | 4.5 | .010 |
| 0168 13 19 39 | G 1/4 | M5X.8 | 8 | 17 | 17 | 5 | .012 |
| 0168 13 10 39 | G 1/4 | G 1/8 | 8 | 17 | 17 | 5 | .020 |
| 0168 17 10 39 | G 3/8 | G 1/8 | 10 | 19 | 22 | 5 | .028 |
| 0168 17 13 39 | G 3/8 | G 1/4 | 10 | 19 | 22 | 5 | .035 |
| 0168 21 10 39 | G 1/2 | G 1/8 | 12 | 24 | 26 | 7.5 | .039 |
| 0168 21 13 39 | G 1/2 | G 1/4 | 12 | 24 | 26 | 7.5 | .056 |
| 0168 21 17 39 | G 1/2 | G 3/8 | 12 | 24 | 26 | 7.5 | .062 |
| 0168 27 13 39 | G 3/4 | G 1/4 | 12 | 32 | 32 | 9.5 | .067 |
| 0168 27 17 39 | G 3/4 | G 3/8 | 12 | 32 | 32 | 9.5 | .097 |
| 0168 27 21 39 | G 3/4 | G 1/2 | 12 | 32 | 32 | 9.5 | .116 |

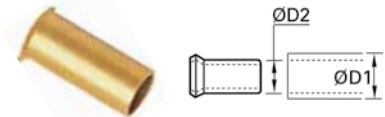

0127 Tube Support for Plastic Tube

| PART NO. | ØD1 MM | ØD2 MM | WT |
|------------|--------|--------|------|
| 0127 04 00 | 4 | 2 | .001 |
| 0127 04 27 | 4 | 2.7 | .001 |
| 0127 05 03 | 5 | 3 | .001 |
| 0127 05 00 | 5 | 3.3 | .001 |
| 0127 06 00 | 6 | 4 | .001 |
| 0127 08 55 | 8 | 5.5 | .001 |
| 0127 08 00 | 8 | 6 | .001 |
| 0127 10 07 | 10 | 7 | .002 |
| 0127 10 75 | 10 | 7.5 | .002 |
| 0127 10 00 | 10 | 8 | .002 |
| 0127 12 08 | 12 | 8 | .002 |
| 0127 12 09 | 12 | 9 | .002 |
| 0127 12 00 | 12 | 10 | .002 |
| 0127 14 11 | 14 | 11 | .003 |
| 0127 14 00 | 14 | 12 | .003 |
| 0127 15 12 | 15 | 12 | .003 |
| 0127 16 13 | 16 | 13 | .003 |
| 0127 18 14 | 18 | 14 | .004 |
| 0127 20 15 | 20 | 15 | .004 |
| 0127 22 16 | 22 | 16 | .005 |
| 0127 25 19 | 25 | 19 | .005 |

At high temperature and pressure or during oscillating movements, the use of tube supports prevents distortion of the tube and guarantees effective gripping and sealing.

WARNING These products can expose you to chemicals including LEAD which is known to the state of California to cause cancer and birth defects or other reproductive harm. For more information go to www.P65Warnings.ca.gov.



A
B
C
D
E
F
G
H
I
J
K
L
M
N
O



Poly-Tite Fittings

Parker's Poly-Tite Fittings are compact, pre-assembled compression style fittings designed for fast assembly. An exclusive acetal copolymer sleeve has superior resilience to resist creeping and stress caused from compression.

Product Features:

- Self aligning captive sleeve
- Built-in tube support
- Knurled nuts for hand tightening
- Plastic and brass sleeves available
- Chrome plated and stainless steel side latch couplers available

Markets:

- Dental
- Packaging
- Machine Tools
- Car Wash
- Printing

Applications:

- Pneumatic Systems
- Water Lines
- Dental Equipment

Specifications:

| | |
|--------------------------|---|
| Pressure Range | Up to 150 PSI (10.3 bar) |
| Temperature Range | 0° to +150° F (-17.7° to +65.5° C) |
| O-rings | Buna N on chrome plated couplers Fluorocarbon on Stainless Steel couplers |

Compatible Tubing:

- Polyethylene
- Nylon
- Polypropylene
- Vinyl

Assembly Instructions

Polyethylene, polypropylene and vinyl tubing:

1. Cut tubing squarely—maximum of 15° angle allowable.
2. Check that port or mating part is clean and free of debris.
3. Insert tube end until it bottoms in the Poly-Tite fitting and tighten knurl/hex nut finger-tight — plus one wrench turn.

Tube Support O.D.

| TUBE SIZE INCHES | * D1 TUBE SUPPORT O.D. |
|------------------|------------------------|
| 1/4 | .168 |
| 5/16 | .185 |
| 3/8 | .248 |
| 1/2 | .373 |

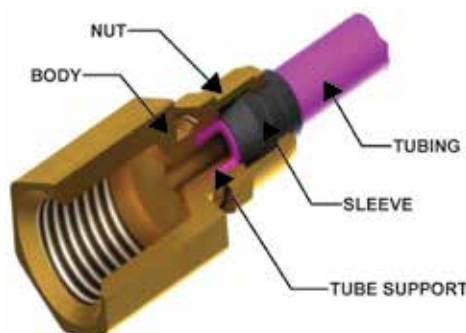
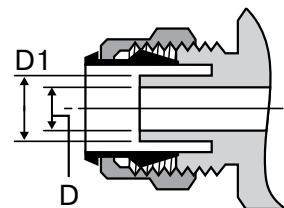

WARNING These products can expose you to chemicals including NICKEL or LEAD, which are known to the state of California to cause cancer, and LEAD which is known to cause birth defects or other reproductive harm. For more information go to www.P65Warnings.ca.gov.



Click here for CADs, Product Specifications or to Configure Parts Online

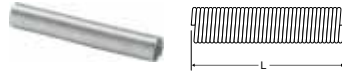

Spring Guard 56PSG

| PART NO. | TUBE O.D. | L |
|----------|-----------|-------|
| 56PSG-4 | 1/4 | 3.000 |
| 56PSG-6 | 3/8 | 3.000 |

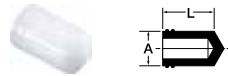

Plastic Cap 59P

| PART NO. | TUBE SIZE | A | L |
|----------|-----------|------|-----|
| 59P-4 | 1/4 | .247 | .50 |
| 59P-6 | 3/8 | .372 | .56 |

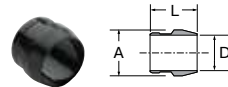

Acetal Plastic Sleeve 60P

| PART NO. | TUBE SIZE | A | D | L |
|----------|-----------|------|------|------|
| 60P-4 | 1/4 | .334 | .261 | .338 |
| 60P-5 | 5/16 | .405 | .321 | .340 |
| 60P-6 | 3/8 | .465 | .381 | .367 |
| 60P-8 | 1/2 | .628 | .514 | .399 |

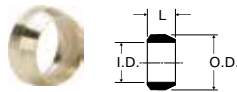

Sleeve 60PB

| PART NO. | L | O.D. | I.D. |
|----------|------|------|------|
| 60PB-4 | .187 | .336 | .255 |
| 60PB-5 | .187 | .400 | .318 |
| 60PB-6 | .218 | .460 | .382 |
| 60PB-8 | .250 | .620 | .507 |



Nut and Plastic Sleeve Assembly 61P

| PART NO. | TUBE SIZE | STRAIGHT THREAD | C HEX | D | L |
|----------|-----------|-----------------|-------|------|-----|
| 61P-4 | 1/4 | 3/8-24 | 7/16 | .261 | .38 |
| 61P-5 | 5/16 | 7/16-24 | 1/2 | .321 | .34 |
| 61P-6 | 3/8 | 1/2-24 | 9/16 | .380 | .38 |
| 61P-8 | 1/2 | 11/16-20 | 3/4 | .514 | .44 |

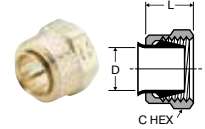

Nut and Brass Sleeve Assembly 61PB

| PART NO. | TUBE SIZE | STRAIGHT THREAD | C HEX | D | L |
|----------|-----------|-----------------|-------|------|-----|
| 61PB-4 | 1/4 | 3/8-24 | 7/16 | .255 | .38 |
| 61PB-5 | 5/16 | 7/16-24 | 1/2 | .318 | .34 |
| 61PB-6 | 3/8 | 1/2-24 | 9/16 | .382 | .38 |
| 61PB-8 | 1/2 | 11/16-20 | 3/4 | .507 | .44 |

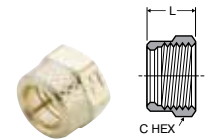

Nut 61PN

| PART NO. | TUBE SIZE | STRAIGHT THREAD | C HEX | L |
|----------|-----------|-----------------|-------|-----|
| 61PN-4 | 1/4 | 3/8-24 | 7/16 | .38 |
| 61PN-5 | 5/16 | 7/16-24 | 1/2 | .34 |
| 61PN-6 | 3/8 | 1/2-24 | 9/16 | .38 |
| 61PN-8 | 1/2 | 11/16-20 | 3/4 | .44 |



Nut only for use with Spring Gaurd 61PSGN

| PART NO. | TUBE O.D. | L | C HEX |
|----------|-----------|------|-------|
| 61PSGN-4 | 1/4 | .625 | .437 |
| 61PSGN-6 | 3/8 | .656 | .562 |

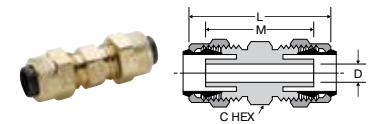

Union 62P

| PART NO. | TUBE SIZE | STRAIGHT THREAD | C HEX | L | M | FLOW DIA. D |
|----------|-----------|-----------------|-------|------|------|-------------|
| 62P-4 | 1/4 | 3/8-24 | 3/8 | 1.17 | .96 | .125 |
| 62P-5 | 5/16 | 7/16-24 | 7/16 | 1.16 | .96 | .144 |
| 62P-6 | 3/8 | 1/2-24 | 1/2 | 1.23 | .99 | .204 |
| 62P-8 | 1/2 | 11/16-20 | 11/16 | 1.47 | 1.24 | .323 |

WARNING These products can expose you to chemicals including NICKEL or LEAD, which are known to the state of California to cause cancer, and LEAD which is known to cause birth defects or other reproductive harm. For more information go to www.P65Warnings.ca.gov.



- A
- B
- C
- D
- E
- F
- G
- H
- I
- J
- K
- L
- M
- N
- O

[Click here for CADs, Product Specifications or to Configure Parts Online](#)

- A
- B
- C
- D
- E
- F
- G
- H
- I
- J
- K
- L
- M
- N
- O

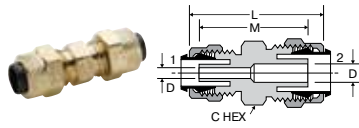

Union Reducer 62P

| PART NO. | 1 TUBE SIZE | 2 TUBE SIZE | 1 STRAIGHT THREAD | 2 STRAIGHT THREAD | C HEX | L | M | FLOW DIA. D |
|----------|-------------|-------------|-------------------|-------------------|-------|------|-----|-------------|
| 62P-6-4 | 1/4 | 3/8 | 3/8-24 | 1/2-24 | 1/2 | 1.22 | .99 | .125 |

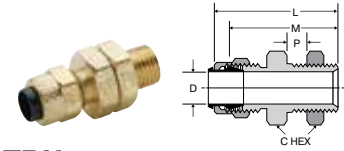

Bulkhead Union 62PTBH

(Straight Through)

| PART NO. | TUBE SIZE | STRAIGHT THREAD | C HEX | P MAX. | L | M | BULKHEAD HOLE DIA. | FLOW DIA. D |
|----------|-----------|-----------------|-------|--------|------|-----|--------------------|-------------|
| 62PTBH-4 | 1/4 | 3/8-24 | 9/16 | .31 | 1.19 | .93 | 3/8 | .260 |
| 62PTBH-5 | 5/16 | 7/16-24 | 5/8 | .31 | 1.19 | .93 | 7/16 | .323 |
| 62PTBH-6 | 3/8 | 1/2-24 | 11/16 | .34 | 1.26 | .99 | 1/2 | .387 |

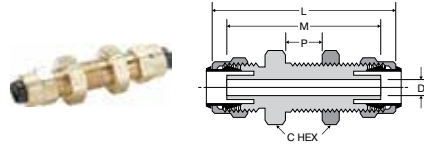

Bulkhead Union 62PBH

| PART NO. | TUBE SIZE | STRAIGHT THREAD | C HEX | P MAX. | L | M | BULKHEAD HOLE DIA. | FLOW DIA. D |
|----------|-----------|-----------------|-------|--------|------|------|--------------------|-------------|
| 62PBH-4 | 1/4 | 3/8-24 | 9/16 | .38 | 1.75 | 1.53 | 3/8 | .125 |
| 62PBH-5 | 5/16 | 7/16-24 | 5/8 | .38 | 1.71 | 1.52 | 7/16 | .144 |
| 62PBH-6 | 3/8 | 1/2-24 | 11/16 | .47 | 1.89 | 1.65 | 1/2 | .204 |
| 62PBH-8 | 1/2 | 11/16-20 | 7/8 | .63 | 2.28 | 2.05 | 11/16 | .323 |

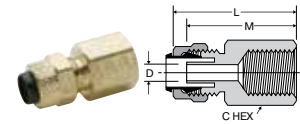

Female Connector 66P

| PART NO. | TUBE SIZE | PIPE THREAD | STRAIGHT THREAD | C HEX | L | M | FLOW DIA. D |
|----------|-----------|-------------|-----------------|-------|------|------|-------------|
| 66P-4-2 | 1/4 | 1/8 | 3/8-24 | 9/16 | .97 | .86 | .125 |
| 66P-4-4 | 1/4 | 1/4 | 3/8-24 | 5/8 | 1.18 | 1.07 | .125 |
| 66P-5-2 | 5/16 | 1/8 | 7/16-24 | 9/16 | .97 | .86 | .144 |
| 66P-6-4 | 3/8 | 1/4 | 1/2-24 | 5/8 | 1.18 | 1.07 | .204 |
| 66P-8-6 | 1/2 | 3/8 | 11/16-20 | 13/16 | 1.31 | 1.20 | .323 |

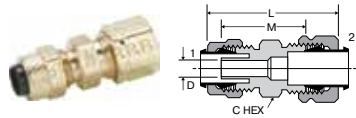

Union 62PCA

(Tube to Compress-Align)

| PART NO. | TUBE SIZE | 1 STRAIGHT THREAD | 2 STRAIGHT THREAD | C HEX | L | M | FLOW DIA. D |
|----------|-----------|-------------------|-------------------|-------|------|-----|-------------|
| 62PCA-4 | 1/4 | 3/8-24 | 7/16-24 | 7/16 | 1.25 | .89 | .125 |
| 62PCA-5 | 5/16 | 7/16-24 | 1/2-24 | 1/2 | 1.30 | .92 | .144 |
| 62PCA-6 | 3/8 | 1/2-24 | 9/16-24 | 9/16 | 1.37 | .98 | .204 |

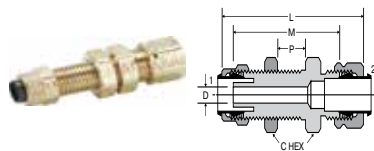

Bulkhead Union 62PCABH

(Tube to Compress-Align)

| PART NO. | TUBE SIZE | 1 STR THD | 2 STR THD | C HEX | P MAX | L | M | BLKHD HOLE DIA. | FLOW DIA. D |
|-----------|-----------|-----------|-----------|-------|-------|------|------|-----------------|-------------|
| 62PCABH-4 | 1/4 | 3/8-24 | 7/16-24 | 9/16 | .38 | 1.81 | 1.45 | 3/8 | .125 |
| 62PCABH-6 | 3/8 | 1/2-24 | 9/16-24 | 11/16 | .47 | 2.03 | 1.64 | 1/2 | .204 |

WARNING These products can expose you to chemicals including NICKEL or LEAD, which are known to the state of California to cause cancer, and LEAD which is known to cause birth defects or other reproductive harm. For more information go to www.P65Warnings.ca.gov.



[Click here for CADs, Product Specifications or to Configure Parts Online](#)

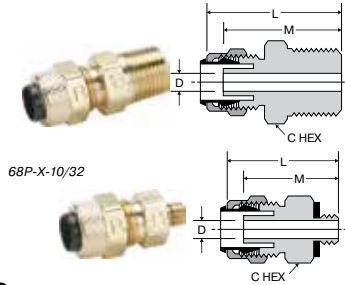

Male Connector 68P

| PART NO. | TUBE SIZE | PIPE THREAD | STRAIGHT THREAD | C HEX | L | M | FLOW DIA. D |
|-------------|-----------|-------------|-----------------|-------|------|------|-------------|
| 68P-4-1 | 1/4 | 1/16 | 3/8-24 | 3/8 | 1.06 | .95 | .125 |
| 68P-4-10X32 | 1/4 | 10-32 | 3/8-24 | 3/8 | .86 | .75 | .094 |
| 68P-4-2 | 1/4 | 1/8 | 3/8-24 | 7/16 | 1.06 | .95 | .125 |
| 68P-4-4 | 1/4 | 1/4 | 3/8-24 | 9/16 | 1.25 | 1.14 | .125 |
| 68P-4-6 | 1/4 | 3/8 | 3/8-24 | 11/16 | 1.28 | 1.17 | .125 |
| 68P-5-2 | 5/16 | 1/8 | 7/16-24 | 7/16 | 1.05 | .95 | .144 |
| 68P-5-4 | 5/16 | 1/4 | 7/16-24 | 9/16 | 1.24 | 1.14 | .144 |
| 68P-6-2 | 3/8 | 1/8 | 1/2-24 | 1/2 | 1.10 | .98 | .204 |
| 68P-6-4 | 3/8 | 1/4 | 1/2-24 | 9/16 | 1.29 | 1.17 | .204 |
| 68P-6-6 | 3/8 | 3/8 | 1/2-24 | 11/16 | 1.29 | 1.17 | .204 |
| 68P-8-4 | 1/2 | 1/4 | 11/16-20 | 11/16 | 1.46 | 1.29 | .320 |
| 68P-8-6 | 1/2 | 3/8 | 11/16-20 | 11/16 | 1.37 | 1.29 | .323 |

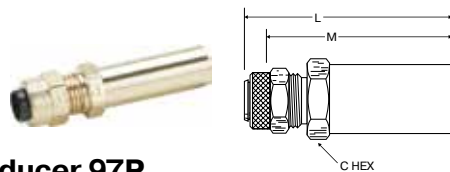

Tube End Reducer 97P

| PART NO. | TUBE O.D. | L | M | C HEX |
|----------|-----------|-------|-------|-------|
| 97P-4-6 | 3/8 X 1/4 | 1.718 | 1.625 | .437 |
| 97P-6-8 | 1/2 X 3/8 | 1.875 | 1.781 | .562 |

Pipe Coupler Body 391P

(Chrome Plated)

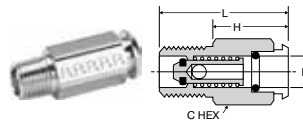

| PART NO. | D-INSERT DIA. | PIPE THREAD | C HEX | H | L |
|----------|---------------|-------------|-------|-----|------|
| 391P-4-2 | 1/4 | 1/8 | 1/2 | .91 | 1.29 |
| 391P-4-4 | 1/4 | 1/4 | 9/16 | .73 | 1.29 |
| 391P-6-4 | 3/8 | 1/4 | 11/16 | .85 | 1.41 |

Pipe Coupler Body 391PSS

(Stainless Steel)

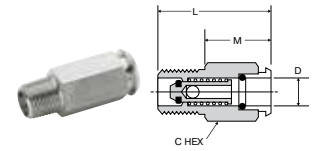

| PART NO. | D INSERT DIA. | PIPE THREAD | L | C HEX | M |
|------------|---------------|-------------|-------|-------|------|
| 391PSS-4-2 | 1/4 | 1/8 | 1.271 | .500 | .900 |
| 391PSS-4-4 | 1/4 | 1/4 | 1.271 | .562 | .710 |
| 391PSS-6-4 | 3/8 | 1/4 | 1.40 | .625 | .840 |

Bulkhead Coupler Body 392P

(Chrome Plated)

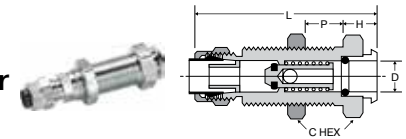

| PART NO. | TUBE SIZE | D-INSERT DIA. | STRAIGHT THREAD | C HEX | P MAX. | H | L | BULKHEAD HOLE DIA. |
|----------|-----------|---------------|-----------------|-------|--------|-----|------|--------------------|
| 392P-4-4 | 1/4 | 1/4 | 1/2-24 | 5/8 | .84 | .39 | 2.13 | 1/2 |
| 392P-6-6 | 3/8 | 3/8 | 11/16-24 | 13/16 | .93 | .37 | 2.01 | 11/16 |

Bulkhead Coupler Body 392PSS

(Stainless Steel)

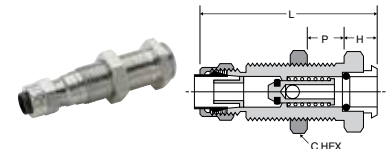

| PART NO. | TUBE O.D. | BULKHEAD THREAD | L | C HEX | H | P MAX | BULKHEAD HOLE DIA. |
|------------|-----------|-----------------|------|-------|-----|-------|--------------------|
| 392PSS-4-4 | 1/4 | 1/2-24 | 2.03 | .625 | .28 | .84 | 1/2 |
| 392PSS-6-6 | 3/8 | 11/16-24 | 2.20 | .812 | .31 | .93 | 11/16 |

Through Type Insert 393P

(Chrome Plated)

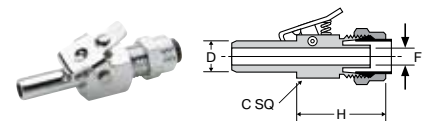

| PART NO. | TUBE SIZE | D-INSERT DIA. | STRAIGHT THREAD | C SQUARE | H | FLOW DIA. F |
|----------|-----------|---------------|-----------------|----------|------|-------------|
| 393P-4-4 | 1/4 | 1/4 | 3/8-24 | 7/16 | 1.12 | .125 |
| 393P-6-6 | 3/8 | 3/8 | 1/2-24 | 1/2 | 1.34 | .203 |

Through Type Insert 393PSS

(Stainless Steel)

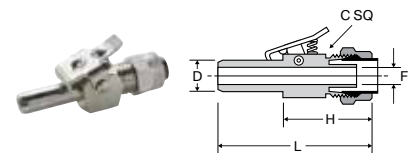

| PART NO. | TUBE O.D. | D-INSERT DIA. | L | C SQUARE | H | FLOW DIA. F |
|------------|-----------|---------------|-------|----------|------|-------------|
| 393PSS-4-4 | 1/4 | 1/4 | 1.677 | 7/16 | .99 | .125 |
| 393PSS-6-6 | 3/8 | 3/8 | 2.030 | 1/2 | 1.27 | .203 |

WARNING These products can expose you to chemicals including NICKEL or LEAD, which are known to the state of California to cause cancer, and LEAD which is known to cause birth defects or other reproductive harm. For more information go to www.P65Warnings.ca.gov.



- A
- B
- C
- D
- E
- F
- G
- H
- I
- J
- K
- L
- M
- N
- O

[Click here for CADs, Product Specifications or to Configure Parts Online](#)

- A
- B
- C
- D
- E
- F
- G
- H
- I
- J
- K
- L
- M
- N
- O

Shutoff Type Insert 393PD

(Chrome Plated)

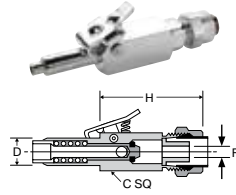

| PART NO. | TUBE SIZE | D-INSERT DIA. | STRAIGHT THREAD | C SQUARE | H | FLOW DIA. F |
|-----------|-----------|---------------|-----------------|----------|------|-------------|
| 393PD-4-4 | 1/4 | 1/4 | 3/8-24 | 7/16 | 1.61 | .110 |
| 393PD-6-6 | 3/8 | 3/8 | 1/2-24 | 1/2 | 1.45 | .187 |

Double End Shutoff Bulkhead Quick Coupler 394PD

(Chrome Plated)

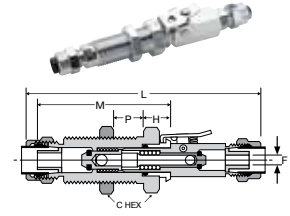

| PART NO. | TUBE SIZE | STRAIGHT THREAD | C HEX | P MAX | H | L | M | BULKHEAD HOLE DIA. | FLOW DIA. F |
|-----------|-----------|-----------------|-------|-------|-----|------|------|--------------------|-------------|
| 394PD-4-4 | 1/4 | 1/2-24 | 5/8 | .84 | .39 | 3.77 | 2.13 | 1/2 | .125 |
| 394PD-6-6 | 3/8 | 11/16-24 | 13/16 | .93 | .37 | 3.48 | 2.01 | 11/16 | .204 |

Shut-Off Type Insert 393PDSS

(Stainless Steel)

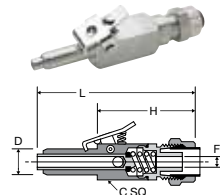

| PART NO. | TUBE O.D. | D-INSERT DIA. | L | C SQUARE | H | FLOW DIA. F |
|-------------|-----------|---------------|------|----------|------|-------------|
| 393PDSS-4-4 | 1/4 | 1/4 | 2.46 | .500 | 1.62 | .116 |
| 393PDSS-6-6 | 3/8 | 3/8 | 2.60 | .500 | 1.67 | .157 |

Double End Shut-Off Bulkhead Quick Coupler 394PDSS

(Stainless Steel)

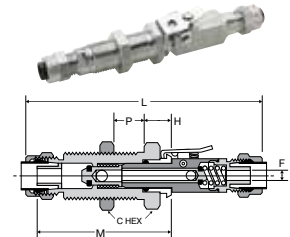

| PART NO. | TUBE O.D. | BULKHEAD THREAD | L | M | C HEX | H | P MAX | FLOW DIA. F |
|-------------|-----------|-----------------|------|------|-------|-----|-------|-------------|
| 394PDSS-4-4 | 1/4 | 1/2-24 | 3.69 | 2.67 | .625 | .32 | .84 | .125 |
| 394PDSS-6-6 | 3/8 | 11/16-24 | 3.91 | 2.24 | .812 | .34 | .93 | .203 |

Single End Shutoff Bulkhead Quick Coupler 394P

(Chrome Plated)

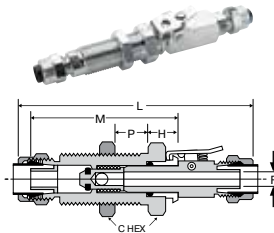

| PART NO. | TUBE SIZE | STRAIGHT THREAD | C HEX | P MAX | H | L | M | BULKHEAD HOLE DIA. | FLOW DIA. F |
|----------|-----------|-----------------|-------|-------|-----|------|------|--------------------|-------------|
| 394P-4-4 | 1/4 | 1/2-24 | 5/8 | .84 | .39 | 3.28 | 2.13 | 1/2 | .125 |
| 394P-6-6 | 3/8 | 11/16-24 | 13/16 | .93 | .37 | 3.41 | 2.01 | 11/16 | .203 |

Single End Shutoff Pipe Connector Quick Coupler 398P

(Chrome Plated)

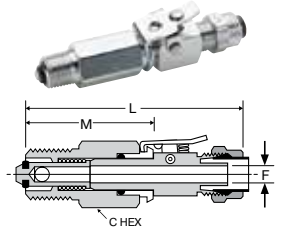

| PART NO. | TUBE SIZE | PIPE THREAD | STRAIGHT THREAD | C HEX | L | M | FLOW DIA. F |
|----------|-----------|-------------|-----------------|-------|------|------|-------------|
| 398P-4-2 | 1/4 | 1/8 | 3/8-24 | 1/2 | 2.45 | 1.32 | .125 |
| 398P-4-4 | 1/4 | 1/4 | 3/8-24 | 9/16 | 2.45 | 1.32 | .125 |
| 398P-6-4 | 3/8 | 1/4 | 1/2-24 | 5/8 | 2.80 | 1.46 | .203 |

Coupler Single End Shut-Off Bulkhead 394PSS

(Stainless Steel)

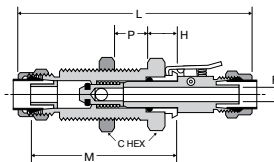

| PART NO. | TUBE O.D. | BULKHEAD THREAD | L | M | C HEX | H | P MAX | FLOW DIA. F |
|------------|-----------|-----------------|------|------|-------|-----|-------|-------------|
| 394PSS-4-4 | 1/4 | 1/2-24 | 3.05 | 2.06 | .625 | .31 | .84 | .125 |
| 394PSS-6-6 | 3/8 | 11/16-24 | 3.50 | 2.23 | .812 | .34 | .93 | .203 |

Single End Shut-Off Connector Quick Coupler 398PSS

(Stainless Steel)

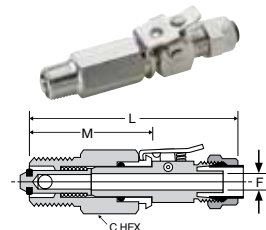

| PART NO. | TUBE O.D. | PIPE THREAD | L | M | C HEX | FLOW DIA. F |
|------------|-----------|-------------|------|------|-------|-------------|
| 398PSS-4-2 | 1/4 | 1/8 | 2.30 | 1.32 | .500 | .125 |
| 398PSS-4-4 | 1/4 | 1/4 | 2.30 | 1.32 | .562 | .125 |
| 398PSS-6-4 | 3/8 | 1/4 | 2.70 | 1.43 | .625 | .203 |

WARNING These products can expose you to chemicals including NICKEL or LEAD, which are known to the state of California to cause cancer, and LEAD which is known to cause birth defects or other reproductive harm. For more information go to www.P65Warnings.ca.gov.



[Click here for CADs, Product Specifications or to Configure Parts Online](#)

Double End Shutoff Pipe Connector Quick Coupler 398PD

(Chrome Plated)

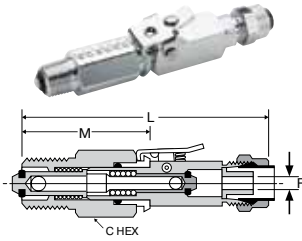

| PART NO. | TUBE SIZE | PIPE THREAD | STRAIGHT THREAD | C HEX | L | M | FLOW DIA. F |
|-----------|-----------|-------------|-----------------|-------|------|------|-------------|
| 398PD-4-2 | 1/4 | 1/8 | 3/8-24 | 1/2 | 2.93 | 1.31 | .125 |
| 398PD-4-4 | 1/4 | 1/4 | 3/8-24 | 9/16 | 2.93 | 1.32 | .125 |
| 398PD-6-4 | 3/8 | 1/4 | 1/2-24 | 5/8 | 2.88 | 1.43 | .204 |

Double End Shut-Off Pipe Connector Quick Coupler 398PDSS

(Stainless Steel)

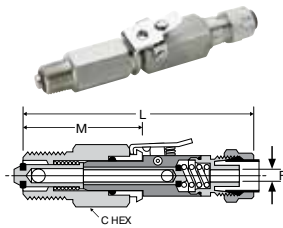

| PART NO. | TUBE O.D. | PIPE THREAD | L | M | C HEX | FLOW DIA. D |
|-------------|-----------|-------------|------|------|-------|-------------|
| 398PDSS-4-2 | 1/4 | 1/8 | 2.93 | 1.31 | .500 | .125 |
| 398PDSS-4-4 | 1/4 | 1/4 | 2.93 | 1.31 | .562 | .125 |
| 398PDSS-6-4 | 3/8 | 1/4 | 3.10 | 1.43 | .625 | .125 |

Union Tee 164P

| PART NO. | TUBE SIZE | STRAIGHT THREAD | L | M | FLOW DIA. D |
|----------|-----------|-----------------|------|------|-------------|
| 164P-4 | 1/4 | 3/8-24 | .84 | .73 | .125 |
| 164P-5 | 5/16 | 7/16-24 | .83 | .73 | .144 |
| 164P-6 | 3/8 | 1/2-24 | .98 | .86 | .203 |
| 164P-8 | 1/2 | 11/16-20 | 1.12 | 1.04 | .323 |

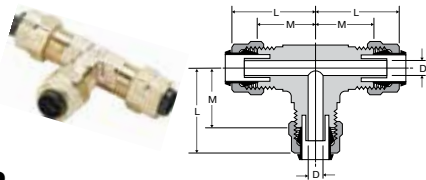

Union Tee 164P combination size

| PART NO. | 1 TUBE SIZE | 2 TUBE SIZE | 3 TUBE SIZE | L | L1 | M | M1 | FLOW DIA. D |
|----------|-------------|-------------|-------------|-----|-----|-----|-----|-------------|
| 164P-6-4 | 3/8 | 3/8 | 1/4 | .98 | .90 | .86 | .79 | .125 |

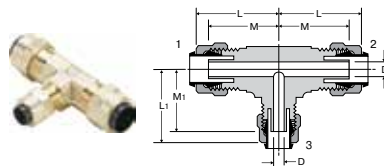

Male Elbow 169P

| PART NO. | TUBE SIZE | PIPE THREAD | STRAIGHT THREAD | L | M | N | FLOW DIA. D |
|----------|-----------|-------------|-----------------|------|------|------|-------------|
| 169P-4-1 | 1/4 | 1/16 | 3/8-24 | .92 | .58 | .67 | .130 |
| 169P-4-2 | 1/4 | 1/8 | 3/8-24 | .84 | .73 | .75 | .121 |
| 169P-4-4 | 1/4 | 1/4 | 3/8-24 | .90 | .79 | .92 | .125 |
| 169P-4-6 | 1/4 | 3/8 | 3/8-24 | .93 | .84 | 1.08 | .125 |
| 169P-5-2 | 5/16 | 1/8 | 7/16-24 | .87 | .73 | .68 | .144 |
| 169P-6-2 | 3/8 | 1/8 | 1/2-24 | .93 | .81 | .73 | .203 |
| 169P-6-4 | 3/8 | 1/4 | 1/2-24 | .98 | .86 | 1.05 | .203 |
| 169P-6-6 | 3/8 | 3/8 | 1/2-24 | .98 | .86 | 1.08 | .203 |
| 169P-8-6 | 1/2 | 3/8 | 11/16-20 | 1.12 | 1.04 | 1.13 | .323 |

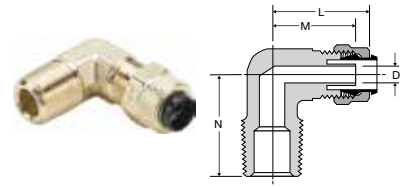

Long Male Elbow 169LP

| PART NO. | TUBE SIZE | PIPE THREAD | STRAIGHT THREAD | L | M | N | FLOW DIA. D |
|-----------|-----------|-------------|-----------------|-----|-----|------|-------------|
| 169LP-4-4 | 1/4 | 1/4 | 3/8-24 | .90 | .79 | 1.38 | .125 |

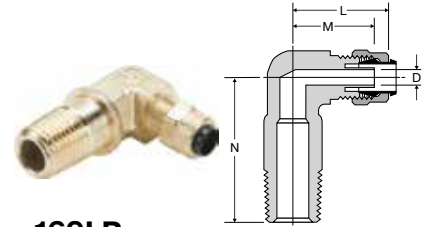

Male Elbow Swivel 169PS

| PART NO. | TUBE O.D. | PIPE THREAD | A | B | C HEX | D | E |
|-----------|-----------|-------------|-------|------|-------|-------|------|
| 169PS-4-2 | 1/4 | 1/8 | .812 | .594 | .375 | .862 | .437 |
| 169PS-4-4 | 1/4 | 1/4 | .906 | .688 | .562 | 1.218 | .562 |
| 169PS-6-2 | 3/8 | 1/8 | .875 | .625 | .437 | .904 | .437 |
| 169PS-6-4 | 3/8 | 1/4 | .937 | .685 | .562 | 1.218 | .562 |
| 169PS-6-6 | 3/8 | 3/8 | .859 | .602 | .562 | 1.190 | .687 |
| 169PS-8-6 | 1/2 | 3/8 | 1.031 | .782 | .500 | 1.218 | .687 |

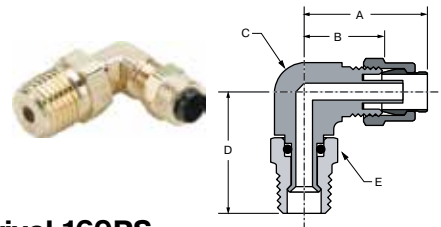

WARNING These products can expose you to chemicals including NICKEL or LEAD, which are known to the state of California to cause cancer, and LEAD which is known to cause birth defects or other reproductive harm. For more information go to www.P65Warnings.ca.gov.



- A
- B
- C
- D
- E
- F
- G
- H
- I
- J
- K
- L
- M
- N
- O

[Click here for CADs, Product Specifications or to Configure Parts Online](#)

- A
- B
- C
- D
- E
- F
- G
- H
- I
- J
- K
- L
- M
- N
- O

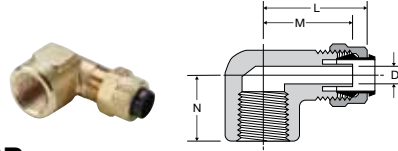

Female Elbow 170P

| PART NO. | TUBE SIZE | PIPE THREAD | STRAIGHT THREAD | L | M | N | FLOW DIA. D |
|----------|-----------|-------------|-----------------|------|------|------|-------------|
| 170P-4-2 | 1/4 | 1/8 | 3/8-24 | .90 | .79 | .56 | .125 |
| 170P-4-4 | 1/4 | 1/4 | 3/8-24 | 1.00 | .89 | .69 | .125 |
| 170P-6-4 | 3/8 | 1/4 | 1/2-24 | 1.01 | .89 | .69 | .204 |
| 170P-8-6 | 1/2 | 3/8 | 11/16-20 | 1.19 | 1.11 | 1.13 | .323 |

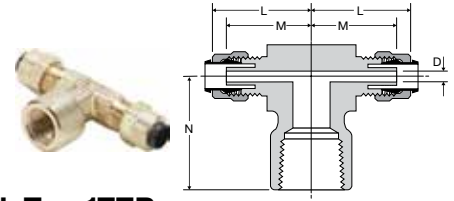

Female Branch Tee 177P

| PART NO. | TUBE SIZE | PIPE THREAD | STRAIGHT THREAD | L | M | N | FLOW DIA. D |
|----------|-----------|-------------|-----------------|------|-----|------|-------------|
| 177P-4-2 | 1/4 | 1/8 | 3/8-24 | .92 | .81 | .88 | .125 |
| 177P-4-4 | 1/4 | 1/4 | 3/8-24 | .92 | .81 | 1.03 | .125 |
| 177P-4-6 | 1/4 | 3/8 | 3/8-24 | 1.03 | .92 | 1.13 | .125 |

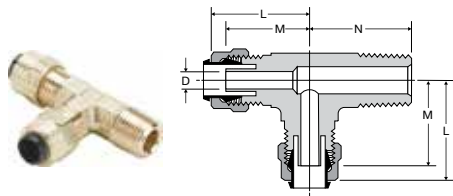

Male Run Tee 171P

| PART NO. | TUBE SIZE | PIPE THREAD | STRAIGHT THREAD | L | M | N | FLOW DIA. D |
|----------|-----------|-------------|-----------------|------|------|------|-------------|
| 171P-4-2 | 1/4 | 1/8 | 3/8-24 | .84 | .73 | .72 | .125 |
| 171P-4-4 | 1/4 | 1/4 | 3/8-24 | .92 | .81 | .92 | .125 |
| 171P-5-2 | 5/16 | 1/8 | 7/16-24 | .83 | .73 | .72 | .144 |
| 171P-6-4 | 3/8 | 1/4 | 1/2-24 | .98 | .86 | 1.03 | .203 |
| 171P-8-6 | 1/2 | 3/8 | 11/16-20 | 1.12 | 1.04 | 1.13 | .323 |

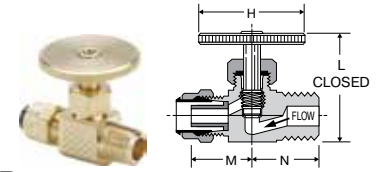

Needle Valve NV311P

| PART NO. | TUBE SIZE | PIPE THREAD | H | L OPEN | L CLOSED | M | N |
|------------|-----------|-------------|------|--------|----------|-----|-----|
| NV311P-4-2 | 1/4 | 1/8 | 1.06 | 1.36 | 1.16 | .64 | .63 |
| NV311P-4-4 | 1/4 | 1/4 | 1.06 | 1.38 | 1.18 | .64 | .72 |
| NV311P-6-4 | 3/8 | 1/4 | 1.06 | 1.38 | 1.18 | .64 | .72 |

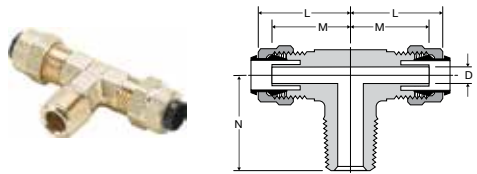

Male Branch Tee 172P

| PART NO. | TUBE SIZE | PIPE THREAD | STRAIGHT THREAD | L | M | N | FLOW DIA. D |
|----------|-----------|-------------|-----------------|------|------|------|-------------|
| 172P-4-2 | 1/4 | 1/8 | 3/8-24 | .84 | .73 | .72 | .125 |
| 172P-4-4 | 1/4 | 1/4 | 3/8-24 | .92 | .81 | .92 | .125 |
| 172P-5-2 | 5/16 | 1/8 | 7/16-24 | .83 | .73 | .72 | .144 |
| 172P-6-2 | 3/8 | 1/8 | 1/2-24 | .88 | .86 | .74 | .204 |
| 172P-6-4 | 3/8 | 1/4 | 1/2-24 | .98 | .86 | 1.03 | .204 |
| 172P-8-6 | 1/2 | 3/8 | 11/16-20 | 1.12 | 1.04 | 1.13 | .323 |

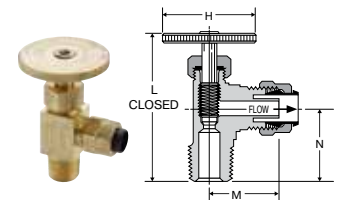

Angle Needle Valve NV312P

| PART NO. | TUBE SIZE | PIPE THREAD | H | L OPEN | L CLOSED | M | N |
|------------|-----------|-------------|------|--------|----------|-----|-----|
| NV312P-4-2 | 1/4 | 1/8 | 1.06 | 1.70 | 1.50 | .63 | .68 |
| NV312P-4-4 | 1/4 | 1/4 | 1.06 | 2.07 | 1.82 | .71 | .86 |
| NV312P-6-4 | 3/8 | 1/4 | 1.06 | 2.00 | 1.75 | .74 | .86 |

WARNING These products can expose you to chemicals including NICKEL or LEAD, which are known to the state of California to cause cancer, and LEAD which is known to cause birth defects or other reproductive harm. For more information go to www.P65Warnings.ca.gov.





Hi-Duty Flareless Tube Fittings

Parker's Hi-Duty Fittings are preassembled with the sleeve machined onto the nut. During assembly the sleeve breaks away from the nut and creates a seal on the tubing. Rated to a much higher pressure rating than compression fittings, Hi-Duty will work with seamless steel tubing as well as copper, brass and thermoplastic tubing.

Product Features:

- All brass construction
- Two piece fitting
- Higher pressure rating
- Easy assembly

Markets:

- Mobile
- Industrial
- Compressors
- Lubrication

Applications:

- Lubrication Lines
- Coolant Lines
- Oil Lines
- Engines

Compatible Tubing:

- Copper
- Brass
- Seamless Steel
- Thermoplastic Tubing

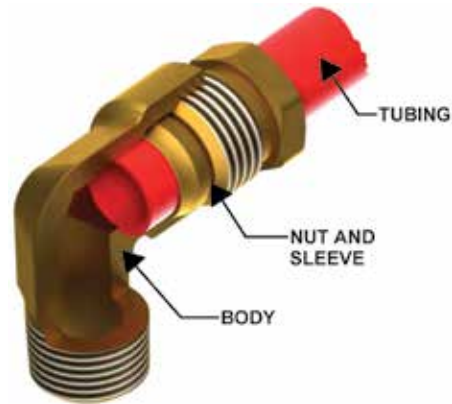

Specifications:

Temperature Range: -65° to +250° F (-53.8° to +121.1° C)

Pressure Range:

| TUBE SIZE | PSI | bar | TUBE SIZE | PSI | bar |
|-----------|------|-------|-----------|------|-------|
| 1/8 | 4300 | 296.4 | 3/8 | 1500 | 103.4 |
| 3/16 | 2850 | 196.5 | 1/2 | 1150 | 79.2 |
| 1/4 | 2100 | 144.7 | 5/8 | 1000 | 68.9 |
| 5/16 | 1800 | 124.1 | | | |

Assembly Instructions

1. Cut tube squarely and cleanly removing all burrs.
2. Grasp fitting. Do not remove nut.
3. Insert tube in fitting through nut until tube seats firmly against tube shoulder in body.
4. Grip tube firmly to prevent turning and tighten nut to finger-tight. Continue to tighten for one and three-quarter additional turns (one and one-half turns for 1/2" size fittings) for a positive, leak proof seal. During tightening a slight "give" will be felt. This "give" indicates the sleeve has been sheared from the nut. It is not necessary to tighten the nut all the way down.



WARNING These products can expose you to chemicals including LEAD which is known to the state of California to cause cancer and birth defects or other reproductive harm. For more information go to www.P65Warnings.ca.gov.



Click here for CADs, Product Specifications or to Configure Parts Online

- A
- B
- C
- D
- E
- F
- G
- H
- I
- J
- K
- L
- M
- N
- O

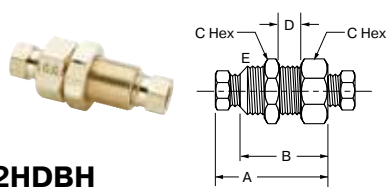

Bulkhead Union 62HDBH

| PART NO. | TUBE SIZE | MIN. ORIFICE SIZE | A | B | C | D | E |
|----------|-----------|-------------------|-------|-------|------|------|---------|
| 62HDBH-2 | 1/8 | .093 | 1.781 | 1.156 | .562 | .625 | 7/16-24 |
| 62HDBH-4 | 1/4 | .187 | 1.968 | 1.156 | .687 | .625 | 9/16-24 |

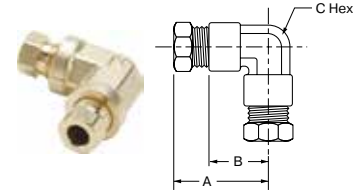

Union Elbow 165HD

| PART NO. | TUBE SIZE | MIN. ORIFICE SIZE | A | B | C HEX |
|----------|-----------|-------------------|-------|-------|-------|
| 165HD-4 | 1/4 | .187 | 1.084 | .690 | .552 |
| 165HD-6 | 3/8 | .312 | 1.376 | .970 | .615 |
| 165HD-8 | 1/2 | .437 | 1.546 | 1.060 | .750 |

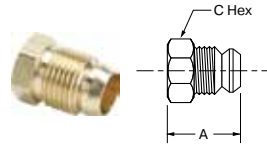

Nut/Sleeve 61HD

| PART NO. | TUBE SIZE | PIPE THREAD | A | C |
|----------|-----------|-------------|-------|------|
| 61HD-2 | 1/8 | 5/16-24 | .656 | .312 |
| 61HD-3 | 3/16 | 3/8-24 | .687 | .375 |
| 61HD-4 | 1/4 | 7/16-24 | .734 | .437 |
| 61HD-5 | 5/16 | 1/2-20 | .765 | .500 |
| 61HD-6 | 3/8 | 9/16-20 | .843 | .562 |
| 61HD-8 | 1/2 | 1 1/16-16 | .921 | .688 |
| 61HD-10 | 5/8 | 7/8-18 | 1.078 | .875 |

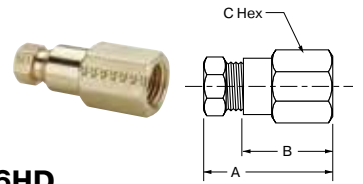

Female Connector 66HD

| PART NO. | TUBE SIZE | PIPE THREAD | MIN. ORIFICE SIZE | A | B | C HEX |
|----------|-----------|-------------|-------------------|-------|-------|-------|
| 66HD-2-2 | 1/8 | 1/8 | .093 | 1.312 | 1.000 | .500 |
| 66HD-4-2 | 1/4 | 1/8 | .187 | 1.406 | 1.000 | .562 |
| 66HD-4-4 | 1/4 | 1/4 | .187 | 1.593 | 1.187 | .687 |
| 66HD-6-2 | 3/8 | 1/8 | .312 | 1.531 | 1.125 | .625 |
| 66HD-6-4 | 3/8 | 1/4 | .312 | 1.718 | 1.312 | .625 |
| 66HD-6-6 | 3/8 | 3/8 | .312 | 1.750 | 1.343 | .812 |

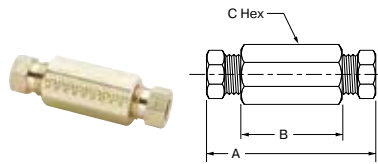

Union 62HD

| PART NO. | TUBE SIZE | MIN. ORIFICE SIZE | A | B | C |
|----------|-----------|-------------------|-------|-------|-------|
| 62HD-2 | 1/8 | .093 | 1.687 | 1.062 | .375 |
| 62HD-3 | 3/16 | .125 | 1.781 | 1.031 | .437 |
| 62HD-4 | 1/4 | .187 | 1.906 | 1.093 | .562 |
| 62HD-6 | 3/8 | .312 | 2.187 | 1.375 | .625 |
| 62HD-8 | 1/2 | .437 | 2.437 | 1.562 | .812 |
| 62HD-10 | 5/8 | .500 | 2.937 | 1.812 | 1.062 |

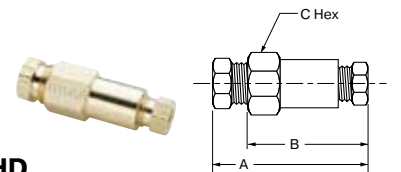

Reducing Union 62HD

| PART NO. | TUBE SIZE | MIN. ORIFICE SIZE | A | B | C HEX |
|----------|-----------|-------------------|-------|-------|-------|
| 62HD-6-4 | 3/8 X 1/4 | .187 | 2.000 | 1.187 | .625 |
| 62HD-8-4 | 1/2 X 1/4 | .187 | 2.125 | 1.281 | .812 |
| 62HD-8-6 | 1/2 X 3/8 | .312 | 2.656 | 1.406 | .812 |

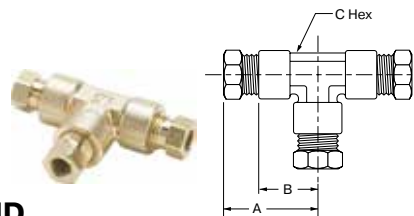

Union Tee 164HD

| PART NO. | TUBE SIZE | MIN. ORIFICE SIZE | A | B | C HEX |
|----------|-----------|-------------------|-------|-------|-------|
| 164HD-4 | 1/4 | .187 | 1.082 | .687 | .500 |
| 164HD-6 | 3/8 | .312 | 1.357 | .970 | .562 |
| 164HD-8 | 1/2 | .437 | 1.481 | 1.060 | .750 |

WARNING These products can expose you to chemicals including LEAD which is known to the state of California to cause cancer and birth defects or other reproductive harm. For more information go to www.P65Warnings.ca.gov.



[Click here for CADs, Product Specifications or to Configure Parts Online](#)

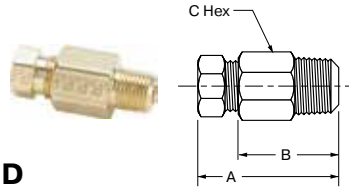

Male Connector 68HD

| PART NO. | TUBE SIZE | PIPE THREAD | MIN. ORIFICE SIZE | A | B | C HEX |
|-----------|-----------|-------------|-------------------|-------|-------|-------|
| 68HD-2-2 | 1/8 | 1/8 | .093 | 1.062 | .750 | .437 |
| 68HD-3-2 | 3/16 | 1/8 | .125 | 1.140 | .765 | .437 |
| 68HD-4-2 | 1/4 | 1/8 | .187 | 1.343 | .937 | .562 |
| 68HD-4-4 | 1/4 | 1/4 | .187 | 1.468 | 1.062 | .562 |
| 68HD-4-6 | 1/4 | 3/8 | .187 | 1.343 | .937 | .687 |
| 68HD-4-8 | 1/4 | 1/2 | .187 | 1.531 | 1.125 | .875 |
| 68HD-5-2 | 5/16 | 1/8 | .218 | 1.406 | 1.000 | .562 |
| 68HD-5-4 | 5/16 | 1/4 | .218 | 1.500 | 1.093 | .562 |
| 68HD-6-2 | 3/8 | 1/8 | .218 | 1.531 | 1.125 | .625 |
| 68HD-6-4 | 3/8 | 1/4 | .312 | 1.656 | 1.250 | .625 |
| 68HD-6-6 | 3/8 | 3/8 | .312 | 1.531 | 1.125 | .687 |
| 68HD-6-8 | 3/8 | 1/2 | .312 | 1.531 | 1.125 | .875 |
| 68HD-8-4 | 1/2 | 1/4 | .312 | 1.813 | 1.375 | .812 |
| 68HD-8-6 | 1/2 | 3/8 | .406 | 1.750 | 1.312 | .812 |
| 68HD-8-8 | 1/2 | 1/2 | .437 | 1.812 | 1.375 | .875 |
| 68HD-8-12 | 1/2 | 3/4 | .437 | 1.625 | 1.187 | 1.062 |
| 68HD-10-6 | 5/8 | 3/8 | .406 | 2.031 | 1.468 | 1.062 |
| 68HD-10-8 | 5/8 | 1/2 | .500 | 2.156 | 1.593 | 1.062 |

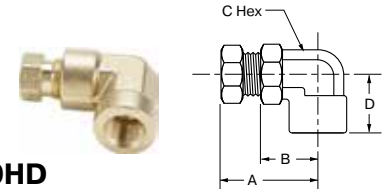

Female Elbow 170HD

| PART NO. | TUBE SIZE | PIPE THREAD | MIN. ORIFICE SIZE | A | B | C HEX | D |
|-----------|-----------|-------------|-------------------|-------|-------|-------|-------|
| 170HD-2-2 | 1/8 | 1/8 | .093 | 1.005 | .690 | .500 | .750 |
| 170HD-4-2 | 1/4 | 1/8 | .187 | 1.084 | .687 | .500 | .750 |
| 170HD-4-4 | 1/4 | 1/4 | .187 | 1.234 | .843 | .562 | .875 |
| 170HD-6-2 | 3/8 | 1/8 | .312 | 1.281 | .875 | .562 | .937 |
| 170HD-6-4 | 3/8 | 1/4 | .312 | 1.376 | .970 | .615 | 1.093 |
| 170HD-6-6 | 3/8 | 3/8 | .312 | 1.526 | 1.120 | .690 | 1.150 |
| 170HD-8-6 | 1/2 | 3/8 | .437 | 1.481 | 1.062 | .740 | 1.281 |

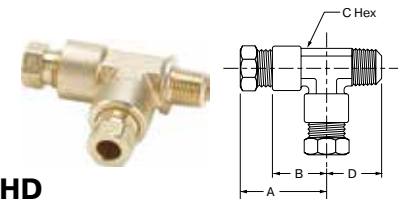

Male Run Tee 171HD

| PART NO. | TUBE SIZE | PIPE THREAD | MIN. ORIFICE SIZE | A | B | C HEX | D |
|-----------|-----------|-------------|-------------------|-------|------|-------|-------|
| 171HD-4-2 | 1/4 | 1/8 | .187 | 1.144 | .750 | .500 | .780 |
| 171HD-4-4 | 1/4 | 1/4 | .187 | 1.207 | .812 | .500 | .937 |
| 171HD-6-4 | 3/8 | 1/4 | .312 | 1.376 | .970 | .562 | 1.000 |

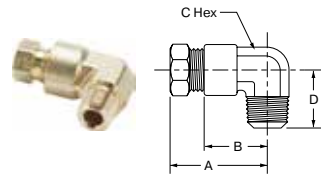

Male Elbow 169HD

| PART NO. | TUBE SIZE | PIPE THREAD | MIN. ORIFICE SIZE | A | B | C HEX | D |
|------------|-----------|-------------|-------------------|-------|-------|-------|-------|
| 169HD-2-2 | 1/8 | 1/8 | .093 | .975 | .656 | .438 | .720 |
| 169HD-3-2 | 3/16 | 1/8 | .125 | 1.056 | .687 | .437 | .750 |
| 169HD-4-2 | 1/4 | 1/8 | .187 | 1.084 | .687 | .500 | .750 |
| 169HD-4-4 | 1/4 | 1/4 | .187 | 1.144 | .750 | .500 | .937 |
| 169HD-5-2 | 5/16 | 1/8 | .218 | 1.144 | .750 | .562 | .810 |
| 169HD-5-4 | 5/16 | 1/4 | .250 | 1.206 | .812 | .562 | 1.000 |
| 169HD-6-2 | 3/8 | 1/8 | .218 | 1.281 | .875 | .562 | .875 |
| 169HD-6-4 | 3/8 | 1/4 | .312 | 1.281 | .875 | .562 | 1.000 |
| 169HD-6-6 | 3/8 | 3/8 | .312 | 1.376 | .970 | .615 | 1.031 |
| 169HD-6-8 | 3/8 | 1/2 | .312 | 1.526 | 1.120 | .687 | 1.310 |
| 169HD-8-4 | 1/2 | 1/4 | .312 | 1.421 | 1.000 | .678 | 1.062 |
| 169HD-8-6 | 1/2 | 3/8 | .406 | 1.421 | 1.000 | .678 | 1.062 |
| 169HD-8-8 | 1/2 | 1/2 | .437 | 1.481 | 1.060 | .740 | 1.420 |
| 169HD-10-6 | 5/8 | 3/8 | .406 | 1.818 | 1.270 | .875 | 1.340 |
| 169HD-10-8 | 5/8 | 1/2 | .500 | 1.818 | 1.270 | .875 | 1.480 |

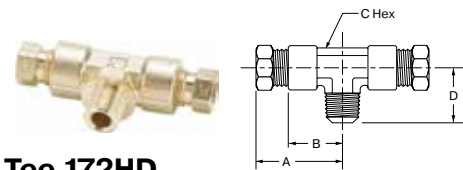

Male Branch Tee 172HD

| PART NO. | TUBE SIZE | PIPE THREAD | MIN. ORIFICE SIZE | A | B | C HEX | D |
|-----------|-----------|-------------|-------------------|-------|-------|-------|-------|
| 172HD-4-2 | 1/4 | 1/8 | .187 | 1.082 | .687 | .500 | .780 |
| 172HD-4-4 | 1/4 | 1/4 | .187 | 1.269 | .875 | .500 | .937 |
| 172HD-6-6 | 3/8 | 3/8 | .312 | 1.406 | 1.000 | .562 | 1.125 |

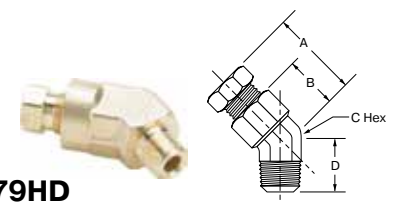

45° Male Elbow 179HD

| PART NO. | TUBE SIZE | PIPE THREAD | MIN. ORIFICE SIZE | A | B | C HEX | D |
|-----------|-----------|-------------|-------------------|-------|------|-------|------|
| 179HD-4-2 | 1/4 | 1/8 | .187 | 1.093 | .687 | .562 | .750 |
| 179HD-6-4 | 3/8 | 1/4 | .280 | 1.138 | .710 | .550 | .850 |

WARNING These products can expose you to chemicals including LEAD which is known to the state of California to cause cancer and birth defects or other reproductive harm. For more information go to www.P65Warnings.ca.gov.



- A
- B
- C
- D
- E
- F
- G
- H
- I
- J
- K
- L
- M
- N
- O

[Click here for CADs, Product Specifications or to Configure Parts Online](#)

- A
- B
- C
- D
- E
- F
- G
- H
- I
- J
- K
- L
- M
- N
- O

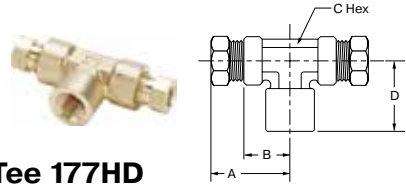

Female Branch Tee 177HD

| PART NO. | TUBE SIZE | PIPE THREAD | MIN. ORIFICE SIZE | A | B | C HEX | D |
|-----------|-----------|-------------|-------------------|-------|------|-------|-------|
| 177HD-4-2 | 1/4 | 1/8 | .187 | 1.082 | .687 | .500 | .750 |
| 177HD-4-4 | 1/4 | 1/4 | .187 | 1.144 | .750 | .562 | 1.093 |
| 177HD-6-4 | 3/8 | 1/4 | .312 | 1.376 | .970 | .562 | 1.093 |

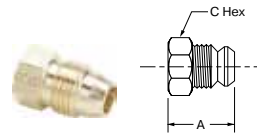

Plug 59HD

| PART NO. | TUBE SIZE | A | C |
|----------|-----------|------|------|
| 59HD-4 | 1/4 | .734 | .437 |
| 59HD-6 | 3/8 | .843 | .625 |

WARNING These products can expose you to chemicals including LEAD which is known to the state of California to cause cancer and birth defects or other reproductive harm. For more information go to www.P65Warnings.ca.gov.





Industrial Flare Fittings

45° Flare Fittings















Inverted Flared Fittings

Access Valves











Flare to Male NPT

| | | | | | |
|---|---|---|---|--|---|
| 48F Male Connector p. H9 | 145F Branch Tee p. H10 | 149F-249F Male Elbow p. H10 | 151F Run Tee p. H11 | 159F-259F 45° Male Elbow p. H12 | 256F Adapter Tee p. H13 |
|  |  |  |  |  |  |
| 48IFHD Male Connector p. H15 | 245IFHD Branch Tee p. H16 | 249IFHD-249IF Male Elbow p. H16 | 251IFHD Run Tee p. H16 | 259IFHD 45° Male Elbow p. H16 | AVU1 Male Connector p. H18 |
|  |  |  |  |  |  |
| AVE1 Male Elbow p. H18 | AVT3 Run Tee p. H18 | AVC1 Cross p. H18 | | | |
|  |  |  | | | |

Flare to Straight Thread

| | | | |
|---|---|---|---|
| 485F Male Connector p. H9 | 1495F Male Elbow p. H12 | 1595F 45° Male Elbow p. H12 | AVUIFI Male Connector p. H18 |
|  |  |  |  |

Flare to Solder

| | | | | | |
|---|---|---|---|--|---|
| US5 Flare Adapter p. H7 | 43F Connector p. H8 | AVUSE Extended Copper Tube p. H18 | AVTS Solder Tee p. H18 | AVUS3 3 Way Solder p. H19 | AVUS Solder Connector p. H19 |
|  |  |  |  |  |  |

Flare to Female NPT

| | | | | |
|---|---|---|---|--|
| 46F Female Connector p. H9 | 150F Female Elbow p. H11 | 46IFHD Female Connector p. H15 | 250IFHD Female Elbow p. H16 | 252IFHD Branch Tee p. H16 |
|  |  |  |  |  |

WARNING These products can expose you to chemicals including LEAD which is known to the state of California to cause cancer and birth defects or other reproductive harm. For more information go to www.P65Warnings.ca.gov.

Flare to Flare

14FSV
Swivel Nut Connector
p. H7



42F
Union
p. H8



144F-244F
Union Tee
p. H10



155F
Union Elbow
p. H11



166FSV
Swivel Elbow
p. H12



660FHD
Union
p. H13



421FHD
Union
p. H15



2441FHD
Union Tee
p. H15



2551FHD
Branch Tee
p. H16



AVU2
Union
p. H18



AVUR3
Female Connector
p. H18



AVUS4D
Swivel Connector
p. H19



AVTS4
Run Tee
p. H19



AVTS6
Branch Tee
p. H19



Flare to Metric Straight Thread

48F-X-MIX
Male Connector
p. H9



149F-X-MIX
Male Elbow
p. H12



159F-X-MIX
45° Male Elbow
p. H12



Bulkhead Union

AVU2BH
Bulkhead Union
p. H18



AVUS3BH
Bulkhead Union
p. H18



Adapter

1F
Refrigerant Drum
p. H7



661FHD
Reducer
p. H13



664FHD
Female Flare – Pipe
p. H13



88AC
Refrigerant Adapter
p. H19



880AC
Refrigerant Adapter
p. H19



881AC
Refrigerant Adapter
p. H19



Accessories

2GF
Flare Gasket
p. H7



3GF
Seal Bonnet
p. H7



14FL
Long Forged Nut
p. H7



14FS
Short Forged Nut
p. H7



14FSX
Short Forged Nut
p. H7



41FL
Long Nut
p. H8



41FS/41FX
Short Nut
p. H8



639F
Seal Plug
p. H13



640F
Cap Nut
p. H13



411F
Inverted Flare Nut
p. H15



411FS
Inverted Flare Nut
p. H15



411FF
Inverted Flare Piloted Nut
p. H15



640QSF
Seal Cap
p. H19



640QSFCR
Seal Cap with Core Remover
p. H19



CR
Core Remover
p. H19



VC
Valve Core
p. H19



WARNING These products can expose you to chemicals including LEAD which is known to the state of California to cause cancer and birth defects or other reproductive harm. For more information go to www.P65Warnings.ca.gov.

- A
- B
- C
- D
- E
- F
- G
- H
- I
- J
- K
- L
- M
- N
- O

A
B
C
D
E
F
G
H
I
J
K
L
M
N
O



45° Flare Fittings

Parker's Flare Fittings is an economical choice for a metal-to-metal seal that resists mechanical pullout. Meets functional requirements of SAE J512 and SAE J513.

Product Features:

- All brass construction
- Resists vibration with use of long nut
- UL listing
- Functional requirements of SAE J512 and J513

Applications:

- Refrigerant Lines
- Propane
- Fuels
- Adapters
- Natural Gas

Markets:

- Refrigeration
- Heavy Duty Truck
- Mobile
- Industrial
- Heating
- Air Conditioning

Compatible Tubing:

- Copper
- Brass
- Aluminum
- Welded Steel Hydraulic Tubing



Specifications:

Temperature Range: -65° to +250° F (-53.8° to 121.1° C)

Pressure Range:

| TUBE SIZE | PSI | bar | TUBE SIZE | PSI | bar |
|-----------|------|-------|-----------|------|------|
| 1/8 | 2800 | 193.0 | 3/8 | 1000 | 68.9 |
| 3/16 | 1900 | 131.0 | 1/2 | 750 | 51.7 |
| 1/4 | 1400 | 96.5 | 5/8 | 650 | 44.8 |
| 5/16 | 1200 | 82.7 | 3/4 | 550 | 37.9 |

Assembly Instructions

1. Cut tubing squarely and clean tube end thoroughly to remove burrs.
2. Place nut onto tube. Place threaded end of nut toward end of tube.
3. Flare tube end with flaring tool to provide 45° flare.
4. Clamp tube flare between nut and nose of fitting body by screwing nut on finger-tight. Tighten with a wrench an additional 1/4 to 1/2 turn past finger-tight for a metal-to-metal seal.



WARNING These products can expose you to chemicals including LEAD which is known to the state of California to cause cancer and birth defects or other reproductive harm. For more information go to www.P65Warnings.ca.gov.



Click here for CADs, Product Specifications or to Configure Parts Online

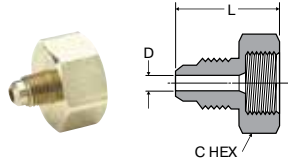

Refrigerant Drum Adapter 1F

Ref. SAE 010165

| PART NO. | TUBE O.D. | PIPE THREAD | C HEX | L | FLOW DIA. D |
|----------|-----------|-------------|-------|------|-------------|
| 1F-4-8 | 1/4 | 1/2 | 1-1/8 | 1.12 | .189 |
| 1F-4-12* | 1/4 | 3/4 | 1-1/4 | 1.12 | .189 |
| 1F-6-12* | 3/8 | 3/4 | 1-1/4 | 1.24 | .282 |
| 1F-8-12* | 1/2 | 3/4 | 1-1/4 | 1.37 | .407 |

Gasket Furnished with each 1F adapter

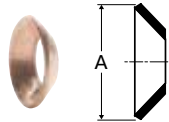

Copper Flare Gasket 2GF

Ref. SAE 010113

| PART NO. | TUBE SIZE | A |
|----------|-----------|-----|
| 2GF-3 | 3/16 | .32 |
| 2GF-4 | 1/4 | .36 |
| 2GF-5 | 5/16 | .43 |
| 2GF-6 | 3/8 | .56 |
| 2GF-8 | 1/2 | .67 |
| 2GF-10 | 5/8 | .78 |
| 2GF-12 | 3/4 | .97 |

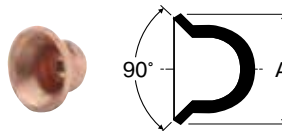

Seal Bonnet 3GF

Ref. SAE 010114

| PART NO. | TUBE SIZE | A |
|----------|-----------|-----|
| 3GF-3 | 3/16 | .32 |
| 3GF-4 | 1/4 | .37 |
| 3GF-5 | 5/16 | .43 |
| 3GF-6 | 3/8 | .56 |
| 3GF-8 | 1/2 | .67 |
| 3GF-10 | 5/8 | .78 |
| 3GF-12 | 3/4 | .97 |

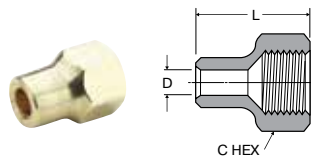

Long Forged Nut 14FL

Ref. SAE 010167

| PART NO. | TUBE SIZE | STRAIGHT THREAD | C HEX | D | L |
|----------|-----------|-----------------|--------|------|------|
| 14FL-4 | 1/4 | 7/16-20 | 5/8 | .257 | .94 |
| 14FL-6 | 3/8 | 5/8-18 | 13/16 | .382 | 1.06 |
| 14FL-8 | 1/2 | 3/4-16 | 15/16 | .507 | 1.19 |
| 14FL-10 | 5/8 | 7/8-14 | 1-1/16 | .632 | 1.44 |

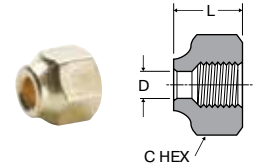

Short Forged Nut 14FSX

Ref. SAE 010166

| PART NO. | TUBE SIZE | STRAIGHT THREAD | C HEX | D | L |
|----------|-----------|-----------------|--------|------|------|
| 14FSX-4 | 1/4 | 7/16-20 | 5/8 | .257 | .63 |
| 14FSX-5 | 5/16 | 1/2-20 | 11/16 | .320 | .67 |
| 14FSX-6 | 3/8 | 5/8-18 | 13/16 | .382 | .74 |
| 14FSX-8 | 1/2 | 3/4-16 | 15/16 | .507 | .86 |
| 14FSX-10 | 5/8 | 7/8-14 | 1-1/16 | .632 | .97 |
| 14FSX-12 | 3/4 | 1-1/16-14 | 1-5/16 | .757 | 1.17 |

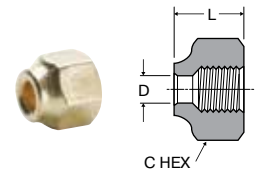

Short Forged Reducing Nuts 14FS

| PART NO. | TUBE SIZE | STRAIGHT THREAD | C HEX | D | L |
|-----------|------------|-----------------|--------|------|-----|
| 14FS-6-4 | 3/8 TO 1/4 | 5/8-18 | 13/16 | .257 | .74 |
| 14FS-8-6 | 1/2 TO 3/8 | 3/4-16 | 15/16 | .382 | .86 |
| 14FS-10-8 | 5/8 TO 1/2 | 7/8-14 | 1-1/16 | .507 | .99 |

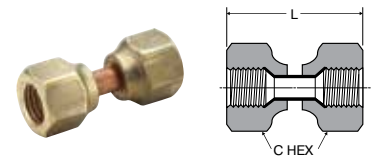

Swivel Nut Valve Connector 14FSV

Ref. SAE 010108

| PART NO. | TUBE SIZE | STRAIGHT THREAD | C HEX | L MIN. |
|----------|-----------|-----------------|--------|--------|
| 14FSV-4 | 1/4 | 7/16-20 | 5/8 | 1.31 |
| 14FSV-6 | 3/8 | 5/8-18 | 13/16 | 1.50 |
| 14FSV-8 | 1/2 | 3/4-16 | 15/16 | 1.75 |
| 14FSV-10 | 5/8 | 7/8-14 | 1-1/16 | 2.00 |

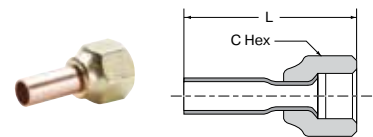

Flare Adapter US5

| PART NO. | TUBE SIZE | STRAIGHT THREAD | C HEX | L |
|----------|-----------|-----------------|-------|------|
| US5-4 | 1/4 | 7/16-20 | 5/8 | 1.50 |
| US5-6 | 3/8 | 5/8-18 | 13/16 | 1.58 |
| US5-8 | 1/2 | 3/4-16 | 15/16 | 1.80 |

WARNING These products can expose you to chemicals including LEAD which is known to the state of California to cause cancer and birth defects or other reproductive harm. For more information go to www.P65Warnings.ca.gov.

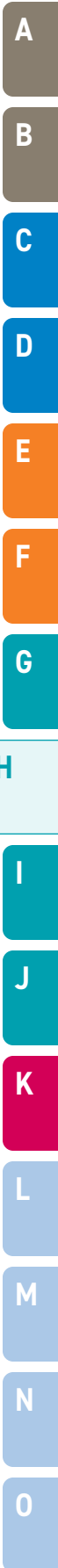

Click here for CADs, Product Specifications or to Configure Parts Online

- A
- B
- C
- D
- E
- F
- G
- H
- I
- J
- K
- L
- M
- N
- O

Long Nut 41FL

REF. SAE 010111

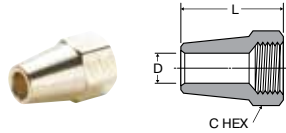

| PART NO. | TUBE SIZE | STRAIGHT THREAD | C HEX | D | L |
|----------|-----------|-----------------|--------|------|------|
| 41FL-2 | 1/8 | 5/16-24 | 3/8 | .133 | .75 |
| 41FL-3 | 3/16 | 3/8-24 | 7/16 | .195 | .81 |
| 41FL-4 | 1/4 | 7/16-20 | 9/16 | .257 | .94 |
| 41FL-5 | 5/16 | 1/2-20 | 5/8 | .320 | 1.12 |
| 41FL-6 | 3/8 | 5/8-18 | 3/4 | .382 | 1.31 |
| 41FL-8 | 1/2 | 3/4-16 | 7/8 | .507 | 1.62 |
| 41FL-10 | 5/8 | 7/8-14 | 1-1/16 | .632 | 1.88 |
| 41FL-12 | 3/4 | 1-1/16-14 | 1-1/4 | .757 | 2.19 |

Short Nut 41FS / Shorter Nut 41FX

REF. SAE 010110

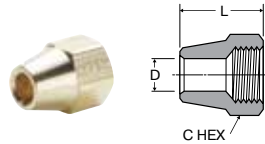

| PART NO. | TUBE SIZE | STRAIGHT THREAD | C HEX | D | L |
|----------|-----------|-----------------|--------|------|------|
| 41FS-2 | 1/8 | 5/16-24 | 3/8 | .132 | .50 |
| 41FS-3 | 3/16 | 3/8-24 | 7/16 | .195 | .62 |
| 41FS-4 | 1/4 | 7/16-20 | 9/16 | .257 | .75 |
| 41FS-5 | 5/16 | 1/2-20 | 5/8 | .320 | .88 |
| 41FS-6 | 3/8 | 5/8-18 | 3/4 | .382 | 1.00 |
| 41FX-6 | 3/8 | 5/8-18 | 3/4 | .382 | .91 |
| 41FS-8 | 1/2 | 3/4-16 | 7/8 | .507 | 1.12 |
| 41FX-8 | 1/2 | 3/4-16 | 7/8 | .507 | 1.00 |
| 41FS-10 | 5/8 | 7/8-14 | 1-1/16 | .632 | 1.31 |
| 41FX-10 | 5/8 | 7/8-14 | 1-1/16 | .632 | 1.06 |
| 41FX-12 | 3/4 | 1-1/16-14 | 1-1/4 | .757 | 1.17 |
| 41FS-12 | 3/4 | 1-1/16-14 | 1-1/4 | .757 | 1.50 |
| 41FS-14 | 7/8 | 1-1/4-12 | 1-1/2 | .882 | 1.62 |

Union 42F

REF. SAE 010101 *THREAD PROTECTORS

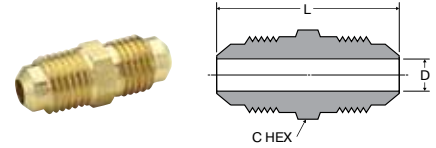

| PART NO. | TUBE SIZE | STRAIGHT THREAD | C HEX | L | D |
|----------|-----------|-----------------|--------|------|------|
| 42F-2 | 1/8 | 5/16-24 | 5/16 | .90 | .079 |
| 42F-3 | 3/16 | 3/8-24 | 3/8 | 1.04 | .125 |
| 42F-4 | 1/4 | 7/16-20 | 7/16 | 1.17 | .189 |
| 42F-5 | 5/16 | 1/2-20 | 1/2 | 1.32 | .220 |
| 42F-6 | 3/8 | 5/8-18 | 5/8 | 1.48 | .282 |
| 42F-8 | 1/2 | 3/4-16 | 3/4 | 1.79 | .407 |
| 42F-10 | 5/8 | 7/8-14 | 7/8 | 2.10 | .501 |
| 42F-12* | 3/4 | 1-1/16-14 | 1-1/16 | 2.42 | .626 |
| 42F-14* | 7/8 | 1-1/4-12 | 1-1/4 | 2.72 | .751 |

Union Reducers 42F

REF. SAE 010101

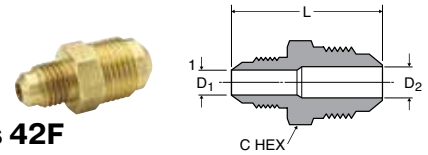

| PART NO. | 1 TUBE SIZE | 2 TUBE SIZE | 1 STRAIGHT THREAD | 2 STRAIGHT THREAD | C HEX | L | FLOW DIA. D1 | FLOW DIA. D2 |
|----------|-------------|-------------|-------------------|-------------------|-------|------|--------------|--------------|
| 42F-6-4 | 1/4 | 3/8 | 7/16-20 | 5/8-18 | 5/8 | 1.36 | .189 | .282 |
| 42F-6-5 | 5/16 | 3/8 | 1/2-20 | 5/8-18 | 5/8 | 1.42 | .220 | .282 |
| 42F-8-4 | 1/4 | 1/2 | 7/16-20 | 3/4-16 | 3/4 | 1.54 | .189 | .407 |
| 42F-8-6 | 3/8 | 1/2 | 5/8-18 | 3/4-16 | 3/4 | 1.67 | .282 | .407 |
| 42F-10-6 | 3/8 | 5/8 | 5/8-18 | 7/8-14 | 7/8 | 1.86 | .282 | .501 |
| 42F-10-8 | 1/2 | 5/8 | 3/4-16 | 7/8-14 | 7/8 | 1.98 | .407 | .501 |

Flare to Solder 43F

REF. SAE 010104

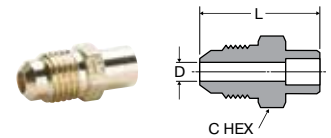

| PART NO. | TUBE SIZE | SOLDER OD | STRAIGHT THREAD | C HEX | L | FLOW DIA. D |
|------------|-----------|-----------|-----------------|--------|------|-------------|
| 43F-4-4 | 1/4 | 1/4 | 7/16-20 | 7/16 | .98 | .189 |
| 43F-4-5 | 1/4 | 5/16 | 7/16-20 | 7/16 | .98 | .189 |
| 43F-4-6 | 1/4 | 3/8 | 7/16-20 | 1/2 | .98 | .189 |
| 43F-6-4 | 3/8 | 1/4 | 5/8-18 | 5/8 | 1.17 | .189 |
| 43F-6-5 | 3/8 | 5/16 | 5/8-18 | 5/8 | 1.17 | .252 |
| 43F-6-6 | 3/8 | 3/8 | 5/8-18 | 5/8 | 1.17 | .282 |
| 43F-6-8 | 3/8 | 1/2 | 5/8-18 | 5/8 | 1.23 | .282 |
| 43F-6-10 | 3/8 | 5/8 | 5/8-18 | 3/4 | 1.36 | .282 |
| 43F-8-6 | 1/2 | 3/8 | 3/4-16 | 3/4 | 1.36 | .314 |
| 43F-8-8 | 1/2 | 1/2 | 3/4-16 | 3/4 | 1.42 | .407 |
| 43F-8-10 | 1/2 | 5/8 | 3/4-16 | 3/4 | 1.54 | .407 |
| 43F-10-8 | 5/8 | 1/2 | 7/8-14 | 7/8 | 1.60 | .440 |
| 43F-10-10 | 5/8 | 5/8 | 7/8-14 | 7/8 | 1.73 | .501 |
| 43F-10-12* | 5/8 | 3/4 | 7/8-14 | 7/8 | 1.86 | .501 |
| 43F-12-12* | 3/4 | 3/4 | 1-1/16-14 | 1-1/16 | 2.04 | .626 |
| 43F-12-14* | 3/4 | 7/8 | 1-1/16-14 | 1-1/16 | 2.17 | .626 |

*Comes standard with thread protectors

WARNING These products can expose you to chemicals including LEAD which is known to the state of California and birth defects or other reproductive harm. For more information go to www.P65Warnings.ca.gov.



[Click here for CADs, Product Specifications or to Configure Parts Online](#)

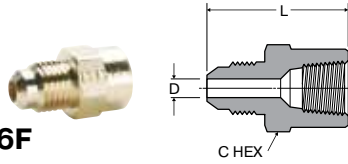

Female Connector 46F

REF. SAE 010103

| PART NO. | TUBE SIZE | PIPE THREAD | STRAIGHT THREAD | C HEX | L | FLOW DIA. D |
|------------|-----------|-------------|-----------------|-------|------|-------------|
| 46F-2-2 | 1/8 | 1/8 | 5/16-24 | 9/16 | .91 | .078 |
| 46F-3-2 | 3/16 | 1/8 | 3/8-24 | 9/16 | .95 | .125 |
| 46F-4-2 | 1/4 | 1/8 | 7/16-20 | 9/16 | 1.01 | .189 |
| 46F-4-4 | 1/4 | 1/4 | 7/16-20 | 11/16 | 1.23 | .189 |
| 46F-4-6 | 1/4 | 3/8 | 7/16-20 | 13/16 | 1.26 | .189 |
| 46F-5-2 | 5/16 | 1/8 | 1/2-20 | 9/16 | 1.05 | .220 |
| 46F-5-4 | 5/16 | 1/4 | 1/2-20 | 11/16 | 1.26 | .220 |
| 46F-6-2 | 3/8 | 1/8 | 5/8-18 | 5/8 | 1.10 | .282 |
| 46F-6-4 | 3/8 | 1/4 | 5/8-18 | 11/16 | 1.29 | .282 |
| 46F-6-6 | 3/8 | 3/8 | 5/8-18 | 13/16 | 1.36 | .282 |
| 46F-6-8 | 3/8 | 1/2 | 5/8-18 | 1 | 1.60 | .282 |
| 46F-8-4 | 1/2 | 1/4 | 3/4-16 | 3/4 | 1.39 | .407 |
| 46F-8-6 | 1/2 | 3/8 | 3/4-16 | 13/16 | 1.48 | .407 |
| 46F-8-8 | 1/2 | 1/2 | 3/4-16 | 1 | 1.73 | .407 |
| 46F-8-12* | 1/2 | 3/4 | 3/4-16 | 1-1/4 | 1.79 | .407 |
| 46F-10-6 | 5/8 | 3/8 | 7/8-14 | 7/8 | 1.57 | .501 |
| 46F-10-8 | 5/8 | 1/2 | 7/8-14 | 1 | 1.80 | .501 |
| 46F-10-12* | 5/8 | 3/4 | 7/8-14 | 1-1/4 | 1.89 | .501 |

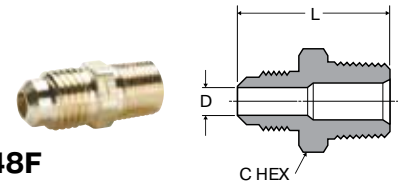

Male Connector 48F

REF. SAE 010102

| PART NO. | TUBE SIZE | PIPE THREAD | STRAIGHT THREAD | C HEX | L | FLOW DIA. D |
|------------|-----------|-------------|-----------------|--------|------|-------------|
| 48F-2-2 | 1/8 | 1/8 | 5/16-24 | 7/16 | .91 | .078 |
| 48F-3-2 | 3/16 | 1/8 | 3/8-24 | 7/16 | .98 | .125 |
| 48F-3-4 | 3/16 | 1/4 | 3/8-24 | 9/16 | 1.17 | .125 |
| 48F-4-2 | 1/4 | 1/8 | 7/16-20 | 7/16 | 1.04 | .189 |
| 48F-4-4 | 1/4 | 1/4 | 7/16-20 | 9/16 | 1.23 | .189 |
| 48F-4-6 | 1/4 | 3/8 | 7/16-20 | 11/16 | 1.29 | .189 |
| 48F-4-8 | 1/4 | 1/2 | 7/16-20 | 7/8 | 1.54 | .189 |
| 48F-5-2 | 5/16 | 1/8 | 1/2-20 | 1/2 | 1.14 | .220 |
| 48F-5-4 | 5/16 | 1/4 | 1/2-20 | 9/16 | 1.32 | .220 |
| 48F-5-6 | 5/16 | 3/8 | 1/2-20 | 11/16 | 1.36 | .220 |
| 48F-6-2 | 3/8 | 1/8 | 5/8-18 | 5/8 | 1.23 | .220 |
| 48F-6-4 | 3/8 | 1/4 | 5/8-18 | 5/8 | 1.42 | .282 |
| 48F-6-6 | 3/8 | 3/8 | 5/8-18 | 11/16 | 1.42 | .282 |
| 48F-6-8 | 3/8 | 1/2 | 5/8-18 | 7/8 | 1.67 | .282 |
| 48F-6-12* | 3/8 | 3/4 | 5/8-18 | 1-1/16 | 1.79 | .282 |
| 48F-8-4 | 1/2 | 1/4 | 3/4-16 | 3/4 | 1.60 | .407 |
| 48F-8-6 | 1/2 | 3/8 | 3/4-16 | 3/4 | 1.60 | .407 |
| 48F-8-8 | 1/2 | 1/2 | 3/4-16 | 7/8 | 1.79 | .407 |
| 48F-8-12 | 1/2 | 3/4 | 3/4-16 | 1-1/16 | 1.92 | .407 |
| 48F-10-4 | 5/8 | 1/4 | 7/8-14 | 7/8 | 1.79 | .313 |
| 48F-10-6 | 5/8 | 3/8 | 7/8-14 | 7/8 | 1.79 | .408 |
| 48F-10-8 | 5/8 | 1/2 | 7/8-14 | 7/8 | 1.98 | .501 |
| 48F-10-12* | 5/8 | 3/4 | 7/8-14 | 1-1/16 | 2.04 | .501 |
| 48F-12-8* | 3/4 | 1/2 | 1-1/16-14 | 1-1/16 | 2.17 | .563 |
| 48F-12-12* | 3/4 | 3/4 | 1-1/16-14 | 1-1/16 | 2.17 | .626 |
| 48F-14-12* | 7/8 | 3/4 | 1-1/4-12 | 1-1/4 | 2.35 | .751 |

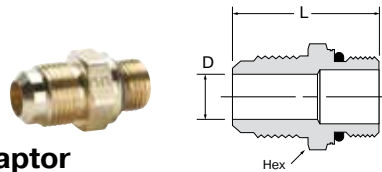

Flare to Metric Adaptor 48F-X-MIX

| PART NUMBER | TUBE SIZE | METRIC THREAD | STRAIGHT THREAD TUBE | HEX | L | D |
|--------------|-----------|---------------|----------------------|-------|------|-----|
| 48F-8-MI16 | 1/2 | M16 X 1.5 | 3/4-16 | 7/8 | 1.60 | .35 |
| 48F-10-MI27 | 5/8 | M27 X 2.0 | 7/8-14 | 1 1/4 | 1.87 | .50 |
| 48F-12-MI27* | 3/4 | M27 X 2.0 | 1 1/16-14 | 1 1/4 | 1.99 | .63 |

Note: Fluorocarbon o-ring is standard

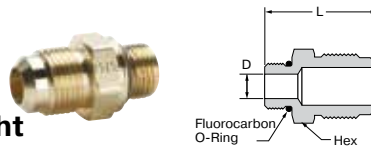

Flare to SAE Straight Thread 485F

| PART NO. | TUBE SIZE | STRAIGHT THREAD | STRAIGHT THREAD TUBE | HEX | L | FLOW DIA. D |
|-------------|-----------|-----------------|----------------------|--------|------|-------------|
| 485F-12-8* | 3/4 | 3/4-16 | 1 1/16-14 | 1 1/16 | 1.80 | .397 |
| 485F-12-12* | 3/4 | 1 1/16-12 | 1 1/16-14 | 1 1/4 | 2.03 | .615 |

*Comes standard with thread protectors

WARNING These products can expose you to chemicals including LEAD which is known to the state of California to cause cancer and birth defects or other reproductive harm. For more information go to www.P65Warnings.ca.gov.

- A
- B
- C
- D
- E
- F
- G
- H
- I
- J
- K
- L
- M
- N
- O

Click here for CADs, Product Specifications or to Configure Parts Online

- A
- B
- C
- D
- E
- F
- G
- H
- I
- J
- K
- L
- M
- N
- O

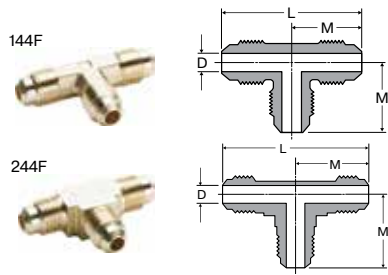

Union Tee 144F-244F

REF. SAE 010401

| PART NO. | TUBE SIZE | STRAIGHT THREAD | L | M | FLOW DIA. D |
|----------|-----------|-----------------|------|------|-------------|
| 144F-3 | 3/16 | 3/8-24 | 1.46 | .73 | .125 |
| 144F-4 | 1/4 | 7/16-20 | 1.72 | .86 | .189 |
| 244F-4 | 1/4 | 7/16-20 | 1.72 | .86 | .189 |
| 144F-5 | 5/16 | 1/2-20 | 1.82 | .91 | .220 |
| 144F-6 | 3/8 | 5/8-18 | 2.08 | 1.04 | .282 |
| 144F-8 | 1/2 | 3/4-16 | 2.46 | 1.23 | .407 |
| 144F-10 | 5/8 | 7/8-14 | 2.78 | 1.39 | .501 |

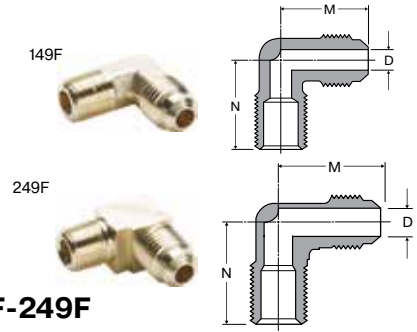

Male Elbow 149F-249F

REF. SAE 010202

| PART NO. | TUBE SIZE | PIPE THREAD | STRAIGHT THREAD | M | N | FLOW DIA. D |
|-------------|-----------|-------------|-----------------|------|------|-------------|
| 149F-2-2 | 1/8 | 1/8 | 5/16-24 | .63 | .69 | .079 |
| 149F-3-2 | 3/16 | 1/8 | 3/8-24 | .75 | .75 | .125 |
| 249F-3-2 | 3/16 | 1/8 | 3/8-24 | .73 | .73 | .125 |
| 149F-4-2 | 1/4 | 1/8 | 7/16-20 | .79 | .76 | .189 |
| 249F-4-2 | 1/4 | 1/8 | 7/16-20 | .79 | .76 | .189 |
| 149F-4-4 | 1/4 | 1/4 | 7/16-20 | .89 | .92 | .189 |
| 249F-4-4 | 1/4 | 1/4 | 7/16-20 | .89 | .92 | .189 |
| 149F-4-6 | 1/4 | 3/8 | 7/16-20 | .92 | 1.01 | .189 |
| 249F-4-6 | 1/4 | 3/8 | 7/16-20 | .92 | 1.01 | .189 |
| 149F-4-8 | 1/4 | 1/2 | 7/16-20 | 1.02 | 1.26 | .189 |
| 149F-5-2 | 5/16 | 1/8 | 1/2-20 | .90 | .79 | .220 |
| 249F-5-2 | 5/16 | 1/8 | 1/2-20 | .89 | .77 | .220 |
| 149F-5-4 | 5/16 | 1/4 | 1/2-20 | .95 | .95 | .220 |
| 249F-5-4 | 5/16 | 1/4 | 1/2-20 | .95 | .92 | .220 |
| 149F-5-6 | 5/16 | 3/8 | 1/2-20 | .98 | 1.01 | .220 |
| 149F-6-2* | 3/8 | 1/8 | 5/8-18 | 1.01 | .90 | .220 |
| 249F-6-2* | 3/8 | 1/8 | 5/8-18 | 1.01 | .89 | .220 |
| 149F-6-4 | 3/8 | 1/4 | 5/8-18 | 1.01 | 1.05 | .282 |
| 249F-6-4 | 3/8 | 1/4 | 5/8-18 | .98 | 1.04 | .282 |
| 149F-6-6 | 3/8 | 3/8 | 5/8-18 | 1.04 | 1.07 | .282 |
| 249F-6-6 | 3/8 | 3/8 | 5/8-18 | 1.04 | 1.07 | .282 |
| 149F-6-8 | 3/8 | 1/2 | 5/8-18 | 1.15 | 1.26 | .282 |
| 249F-6-8 | 3/8 | 1/2 | 5/8-18 | 1.14 | 1.26 | .282 |
| 149F-6-12* | 3/8 | 3/4 | 5/8-18 | 1.25 | 1.38 | .282 |
| 149F-8-4* | 1/2 | 1/4 | 3/4-16 | 1.20 | 1.17 | .314 |
| 149F-8-6 | 1/2 | 3/8 | 3/4-16 | 1.20 | 1.10 | .407 |
| 249F-8-6 | 1/2 | 3/8 | 3/4-16 | 1.20 | 1.10 | .407 |
| 149F-8-8 | 1/2 | 1/2 | 3/4-16 | 1.28 | 1.38 | .407 |
| 249F-8-8 | 1/2 | 1/2 | 3/4-16 | 1.26 | 1.36 | .407 |
| 149F-8-12* | 1/2 | 3/4 | 3/4-16 | 1.38 | 1.38 | .407 |
| 149F-10-4* | 5/8 | 1/4 | 7/8-14 | 1.41 | 1.25 | .314 |
| 149F-10-6* | 5/8 | 3/8 | 7/8-14 | 1.41 | 1.25 | .407 |
| 149F-10-8 | 5/8 | 1/2 | 7/8-14 | 1.40 | 1.39 | .501 |
| 249F-10-8 | 5/8 | 1/2 | 7/8-14 | 1.39 | 1.36 | .501 |
| 149F-10-12* | 5/8 | 3/4 | 7/8-14 | 1.42 | 1.48 | .501 |
| 149F-12-8** | 3/4 | 1/2 | 1-1/16-14 | 1.60 | 1.48 | .563 |
| 149F-12-12* | 3/4 | 3/4 | 1-1/16-14 | 1.60 | 1.62 | .626 |

* For these parts the pipe thread through hole is smaller than the through hole on the flare end.

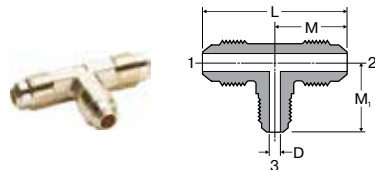

Union Tee 144F combination sizes

| PART NO. | 1 TUBE SIZE | 2 TUBE SIZE | 3 TUBE SIZE | L | M | M1 | FLOW DIA. D |
|------------|-------------|-------------|-------------|------|------|------|-------------|
| 144F-6-6-4 | 3/8 | 3/8 | 1/4 | 2.08 | 1.04 | .89 | .189 |
| 144F-8-8-6 | 1/2 | 1/2 | 3/8 | 2.40 | 1.20 | 1.10 | .282 |

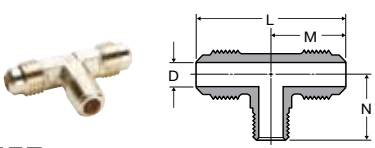

Male Branch Tee 145F

REF. SAE 010425

| PART NO. | TUBE SIZE | PIPE THREAD | STRAIGHT THREAD | L | M | N | FLOW DIA. D |
|-----------|-----------|-------------|-----------------|------|------|------|-------------|
| 145F-2-2 | 1/8 | 1/8 | 5/16-24 | 1.26 | .63 | .69 | .079 |
| 145F-4-2 | 1/4 | 1/8 | 7/16-20 | 1.58 | .79 | .76 | .189 |
| 145F-4-4 | 1/4 | 1/4 | 7/16-20 | 1.78 | .89 | .92 | .189 |
| 145F-5-4 | 5/16 | 1/4 | 1/2-20 | 1.90 | .95 | .96 | .220 |
| 145F-6-4 | 3/8 | 1/4 | 5/8-18 | 1.96 | .98 | 1.05 | .282 |
| 145F-6-6 | 3/8 | 3/8 | 5/8-18 | 2.00 | 1.00 | .98 | .282 |
| 145F-6-8 | 3/8 | 1/2 | 5/8-18 | 2.28 | 1.14 | 1.26 | .282 |
| 145F-8-6 | 1/2 | 3/8 | 3/4-16 | 2.40 | 1.20 | 1.10 | .407 |
| 145F-8-8 | 1/2 | 1/2 | 3/4-16 | 2.46 | 1.23 | 1.36 | .407 |
| 145F-10-8 | 5/8 | 1/2 | 7/8-14 | 2.78 | 1.39 | 1.36 | .501 |

*Comes standard with thread protectors

WARNING These products can expose you to chemicals including LEAD which is known to the state of California to cause cancer and birth defects or other reproductive harm. For more information go to www.P65Warnings.ca.gov.



[Click here for CADs, Product Specifications or to Configure Parts Online](#)

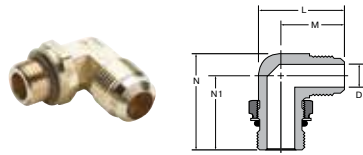

Flare Elbow to SAE Metric Straight Thread 149F-X-MIX

| PART NUMBER | TUBE SIZE | METRIC THREAD | STRAIGHT THREAD TUBE | L | M | N | N1 | D |
|--------------|-----------|---------------|----------------------|------|------|------|------|------|
| 149F-10-MI27 | 5/8 | M27 X 2.0 | 7/8-14 | 1.95 | 1.46 | 2.12 | 1.63 | .501 |

Note: Fluorocarbon o-ring is standard

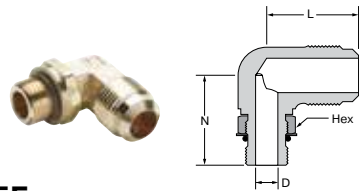

Flare Elbow to SAE Straight Thread 1495F

| PART NO. | TUBE SIZE | STRAIGHT THREAD | STRAIGHT THREAD TUBE | HEX | L | N | FLOW DIA. D |
|--------------|-----------|-----------------|----------------------|-------|------|------|-------------|
| 1495F-12-8* | 3/4 | 3/4-16 | 1 1/16-14 | 7/8 | 1.60 | 1.60 | .398 |
| 1495F-12-12* | 3/4 | 1-1/16-12 | 1 1/16-14 | 1 1/4 | 1.59 | 2.12 | .616 |

Note: Fluorocarbon o-ring is standard

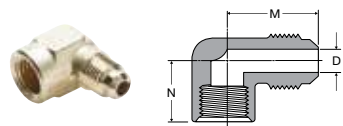

Female Elbow 150F

REF. SAE 010203

| PART NO. | TUBE SIZE | PIPE THREAD | STRAIGHT THREAD | M | N | FLOW DIA. D |
|-------------|-----------|-------------|-----------------|------|-----|-------------|
| 150F-4-2 | 1/4 | 1/8 | 7/16-20 | .86 | .50 | .189 |
| 150F-4-4 | 1/4 | 1/4 | 7/16-20 | .95 | .67 | .189 |
| 150F-5-4 | 5/16 | 1/4 | 1/2-20 | 1.01 | .67 | .220 |
| 150F-6-2 | 3/8 | 1/8 | 5/8-18 | 1.08 | .48 | .282 |
| 150F-6-4 | 3/8 | 1/4 | 5/8-18 | 1.07 | .67 | .282 |
| 150F-6-6 | 3/8 | 3/8 | 5/8-18 | 1.14 | .67 | .282 |
| 150F-6-8 | 3/8 | 1/2 | 5/8-18 | 1.23 | .86 | .282 |
| 150F-8-6 | 1/2 | 3/8 | 3/4-16 | 1.25 | .69 | .407 |
| 150F-8-8 | 1/2 | 1/2 | 3/4-16 | 1.36 | .92 | .407 |
| 150F-8-12 | 1/2 | 3/4 | 3/4-16 | 1.51 | .92 | .407 |
| 150F-10-8* | 5/8 | 1/2 | 7/8-14 | 1.48 | .98 | .501 |
| 150F-10-12* | 5/8 | 3/4 | 7/8-14 | 1.64 | .98 | .501 |

*Comes standard with thread protectors

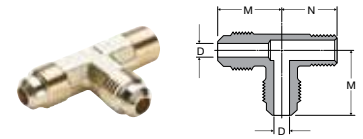

Male Run Tee 151F

REF. SAE 010424

| PART NO. | TUBE SIZE | PIPE THREAD | STRAIGHT THREAD | M | N | FLOW DIA. D |
|-----------|-----------|-------------|-----------------|------|------|-------------|
| 151F-4-2 | 1/4 | 1/8 | 7/16-20 | .86 | .76 | .189 |
| 151F-4-4 | 1/4 | 1/4 | 7/16-20 | .89 | .92 | .189 |
| 151F-5-4 | 5/16 | 1/4 | 1/2-20 | .95 | .92 | .220 |
| 151F-6-4 | 3/8 | 1/4 | 5/8-18 | 1.04 | 1.04 | .282 |
| 151F-6-6 | 3/8 | 3/8 | 5/8-18 | 1.00 | .98 | .282 |
| 151F-6-8 | 3/8 | 1/2 | 5/8-18 | 1.16 | 1.26 | .282 |
| 151F-8-6 | 1/2 | 3/8 | 3/4-16 | 1.20 | 1.10 | .407 |
| 151F-8-8 | 1/2 | 1/2 | 3/4-16 | 1.23 | 1.36 | .407 |
| 151F-10-8 | 5/8 | 1/2 | 7/8-14 | 1.39 | 1.36 | .501 |

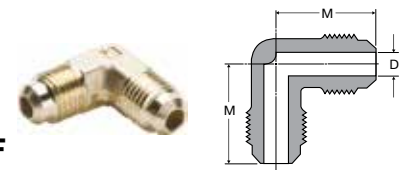

Union Elbow 155F

REF. SAE 010201

| PART NO. | TUBE SIZE | STRAIGHT THREAD | M | FLOW DIA. D |
|----------|-----------|-----------------|------|-------------|
| 155F-2 | 1/8 | 5/16-24 | .64 | .079 |
| 155F-3 | 3/16 | 3/8-24 | .73 | .125 |
| 155F-4 | 1/4 | 7/16-20 | .86 | .189 |
| 155F-5 | 5/16 | 1/2-20 | .92 | .220 |
| 155F-6 | 3/8 | 5/8-18 | 1.04 | .282 |
| 155F-8 | 1/2 | 3/4-16 | 1.20 | .407 |
| 155F-10 | 5/8 | 7/8-14 | 1.39 | .501 |
| 155F-12* | 3/4 | 1-1/16-14 | 1.64 | .626 |

WARNING These products can expose you to chemicals including LEAD which is known to the state of California to cause cancer and birth defects or other reproductive harm. For more information go to www.P65Warnings.ca.gov.



- A
- B
- C
- D
- E
- F
- G
- H
- I
- J
- K
- L
- M
- N
- O

[Click here for CADs, Product Specifications or to Configure Parts Online](#)

- A
- B
- C
- D
- E
- F
- G
- H
- I
- J
- K
- L
- M
- N
- O

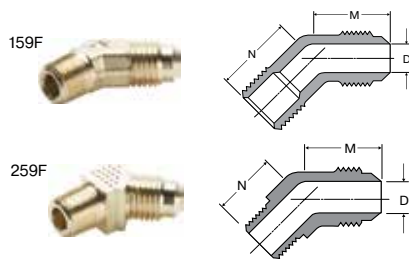

45° Elbow 159F-259F

REF. SAE 010302

| PART NO. | TUBE SIZE | PIPE THREAD | STRAIGHT THREAD | M | N | FLOW DIA. D |
|-------------|-----------|-------------|-----------------|------|------|-------------|
| 159F-4-2 | 1/4 | 1/8 | 7/16-20 | .78 | .56 | .189 |
| 259F-4-2 | 1/4 | 1/8 | 7/16-20 | .65 | .62 | .189 |
| 159F-4-4 | 1/4 | 1/4 | 7/16-20 | .75 | .84 | .189 |
| 259F-4-4 | 1/4 | 1/4 | 7/16-20 | .73 | .84 | .189 |
| 159F-5-2 | 5/16 | 1/8 | 1/2-20 | .76 | .65 | .220 |
| 159F-5-4 | 5/16 | 1/4 | 1/2-20 | .75 | .81 | .220 |
| 159F-6-2* | 3/8 | 1/8 | 5/8-18 | .89 | .67 | .220 |
| 159F-6-4 | 3/8 | 1/4 | 5/8-18 | .89 | .86 | .282 |
| 259F-6-4 | 3/8 | 1/4 | 5/8-18 | .91 | .86 | .282 |
| 159F-6-6 | 3/8 | 3/8 | 5/8-18 | .91 | .93 | .282 |
| 259F-6-6 | 3/8 | 3/8 | 5/8-18 | .91 | .93 | .282 |
| 159F-8-4* | 1/2 | 1/4 | 3/4-16 | 1.06 | .95 | .314 |
| 159F-8-6 | 1/2 | 3/8 | 3/4-16 | 1.06 | .95 | .407 |
| 259F-8-6 | 1/2 | 3/8 | 3/4-16 | 1.04 | .93 | .407 |
| 159F-8-8 | 1/2 | 1/2 | 3/4-16 | 1.12 | 1.16 | .407 |
| 159F-10-6* | 5/8 | 3/8 | 7/8-14 | 1.13 | .95 | .407 |
| 159F-10-8 | 5/8 | 1/2 | 7/8-14 | 1.21 | 1.16 | .501 |
| 159F-12-8** | 3/4 | 1/2 | 1-1/16-14 | 1.28 | 1.16 | .560 |

+ For these parts the pipe thread through hole is smaller than the through hole on the flare end.

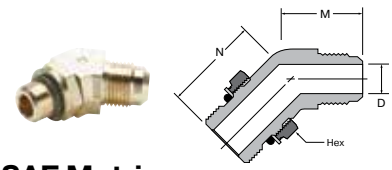

45° Flare Elbow to SAE Metric Straight Thread 159F-X-MIX

| PART NUMBER | TUBE SIZE | METRIC THREAD | STRAIGHT THREAD TUBE | HEX | M | N | D |
|--------------|-----------|---------------|----------------------|-------|------|------|-----|
| 159F-8-MII6 | 1/2 | M16 X 1.5 | 3/4-16 | 22MM | 1.10 | 1.16 | .36 |
| 159F-10-MI27 | 5/8 | M27 X 2.0 | 7/8-14 | 1 1/4 | 1.21 | 1.50 | .50 |

Note: Fluorocarbon o-ring is standard

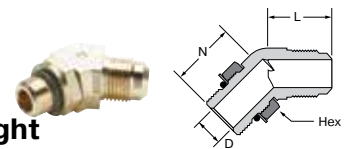

45° Flare to SAE Straight Thread 1595F

| PART NO. | TUBE SIZE | STRAIGHT THREAD | STRAIGHT THREAD TUBE | HEX | L | N | FLOW DIA. D |
|--------------|-----------|-----------------|----------------------|-------|------|------|-------------|
| 1595F-8-8 | 1/2 | 3/4-16 | 3/4-16 | 7/8 | 1.00 | 1.16 | .398 |
| 1595F-12-8* | 3/4 | 3/4-16 | 1 1/16-14 | 7/8 | 1.41 | 1.30 | .398 |
| 1595F-12-12* | 3/4 | 1 1/16-12 | 1 1/16-14 | 1 1/4 | 1.41 | 1.45 | .615 |

Note: Fluorocarbon o-ring is standard

* Comes standard with thread protectors

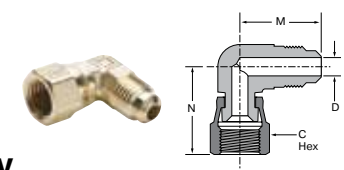

90° Swivel Elbow 166FSV

| PART NO. | TUBE SIZE | STRAIGHT THREAD | C HEX | M | N | FLOW DIA. D |
|---------------|-----------|-----------------|-------|------|------|-------------|
| 166FSV-4-4 | 1/4 | 7/16-20 | 9/16 | .86 | .93 | .189 |
| 166FSV-6-6 | 3/8 | 5/8-18 | 3/4 | 1.04 | 1.12 | .282 |
| 166FSV-8-8 | 1/2 | 3/4-16 | 7/8 | 1.20 | 1.29 | .407 |
| 166FSV-10-10 | 5/8 | 7/8-14 | 1 | 1.39 | 1.50 | .501 |
| 166FSV-12-12* | 3/4 | 1-1/16-14 | 1-1/4 | 1.60 | 1.83 | .626 |

* Comes standard with thread protectors

WARNING These products can expose you to chemicals including LEAD which is known to the state of California to cause cancer and birth defects or other reproductive harm. For more information go to www.P65Warnings.ca.gov.



Click here for CADs, Product Specifications or to Configure Parts Online

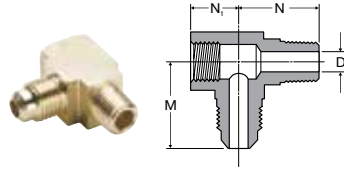

Adapter Tee 256F

| PART NO. | TUBE SIZE | PIPE THREAD | STRAIGHT THREAD | M | N | N1 | FLOW DIA. D |
|----------|-----------|-------------|-----------------|-----|-----|-----|-------------|
| 256F-4-2 | 1/4 | 1/8 | 7/16-20 | .86 | .77 | .47 | .220 |

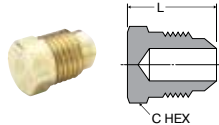

Flared Seal Plug 639F

REF. SAE 010109

| PART NO. | TUBE SIZE | STRAIGHT THREAD | C HEX | L |
|----------|-----------|-----------------|-------|------|
| 639F-4 | 1/4 | 7/16-20 | 7/16 | .69 |
| 639F-5 | 5/16 | 1/2-20 | 1/2 | .78 |
| 639F-6 | 3/8 | 5/8-18 | 5/8 | .88 |
| 639F-8 | 1/2 | 3/4-16 | 3/4 | 1.06 |
| 639F-10 | 5/8 | 7/8-14 | 7/8 | 1.19 |

* Comes standard with thread protectors
 † Should be used with 2GF flare gasket

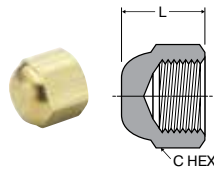

Cap Nut 640F

REF. SAE 010112

| PART NO. | TUBE SIZE | STRAIGHT THREAD | C HEX | L |
|----------|-----------|-----------------|--------|-----|
| 640F-3† | 3/16 | 3/8-24 | 1/2 | .47 |
| 640F-4† | 1/4 | 7/16-20 | 9/16 | .53 |
| 640F-5† | 5/16 | 1/2-20 | 5/8 | .62 |
| 640F-6† | 3/8 | 5/8-18 | 3/4 | .69 |
| 640F-8† | 1/2 | 3/4-16 | 7/8 | .84 |
| 640F-10† | 5/8 | 7/8-14 | 1-1/16 | .97 |

† Should be used with 2GF flare gasket

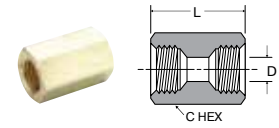

Flared Union-Female Flare to Female Flare 660FHD

REF. SAE 010107

| PART NO. | TUBE SIZE | STRAIGHT THREAD | C HEX | L | FLOW DIA. D |
|------------|-----------|-----------------|--------|------|-------------|
| 660FHD-4† | 1/4 | 7/16-20 | 5/8 | .98 | .251 |
| 660FHD-6† | 3/8 | 5/8-18 | 13/16 | 1.24 | .376 |
| 660FHD-8† | 1/2 | 3/4-16 | 15/16 | 1.43 | .501 |
| 660FHD-10† | 5/8 | 7/8-14 | 1-1/16 | 1.67 | .626 |

† Should be used with 2GF flare gasket

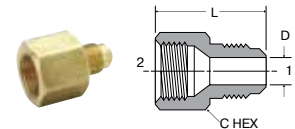

Male Flare to Female Flare 661FHD

REF. SAE 010105

| PART NO. | 1 TUBE SIZE | 2 TUBE SIZE | 1 STRAIGHT THREAD | 2 STRAIGHT THREAD | C HEX | L | FLOW DIA. D |
|----------------|-------------|-------------|-------------------|-------------------|--------|------|-------------|
| 661FHD-4-6† | 1/4 | 3/8 | 7/16-20 | 5/8-18 | 13/16 | 1.20 | .189 |
| 661FHD-4-8† | 1/4 | 1/2 | 7/16-20 | 3/4-16 | 15/16 | 1.36 | .189 |
| 661FHD-6-4† | 3/8 | 1/4 | 5/8-18 | 7/16-20 | 5/8 | 1.10 | .282 |
| 661FHD-6-8† | 3/8 | 1/2 | 5/8-18 | 3/4-16 | 15/16 | 1.42 | .282 |
| 661FHD-8-6† | 1/2 | 3/8 | 3/4-16 | 5/8-18 | 13/16 | 1.39 | .407 |
| 661FHD-8-10† | 1/2 | 5/8 | 3/4-16 | 7/8-14 | 1-1/16 | 1.67 | .407 |
| 661FHD-10-8† | 5/8 | 1/2 | 7/8-14 | 3/4-16 | 15/16 | 1.60 | .501 |
| 661FHD-10-12*† | 5/8 | 3/4 | 7/8-14 | 1-1/16-14 | 1-5/16 | 1.95 | .501 |
| 661FHD-12-10*† | 3/4 | 5/8 | 1-1/16-14 | 7/8-14 | 1-1/16 | 1.86 | .626 |

* Comes standard with thread protectors
 † Should be used with 2GF flare gasket

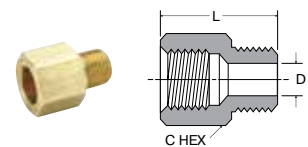

Female Flare to Male Pipe Thread 664FHD

REF. SAE 010106

| PART NO. | TUBE SIZE | PIPE THREAD | STRAIGHT THREAD | C HEX | L | FLOW DIA. D |
|-------------|-----------|-------------|-----------------|-------|------|-------------|
| 664FHD-4-2† | 1/4 | 1/8 | 7/16-20 | 5/8 | .91 | .220 |
| 664FHD-4-4† | 1/4 | 1/4 | 7/16-20 | 5/8 | 1.01 | .252 |
| 664FHD-6-4† | 3/8 | 1/4 | 5/8-18 | 13/16 | 1.28 | .345 |
| 664FHD-8-6† | 1/2 | 3/8 | 3/4-16 | 15/16 | 1.31 | .407 |

† Should be used with 2GF flare gasket

WARNING These products can expose you to chemicals including LEAD which is known to the state of California to cause cancer and birth defects or other reproductive harm. For more information go to www.P65Warnings.ca.gov.

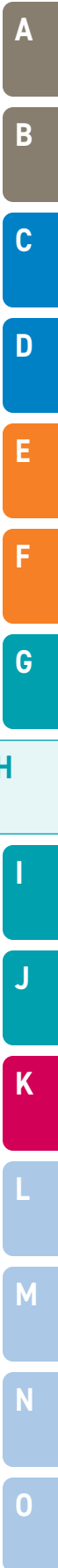

A
B
C
D
E
F
G
H
I
J
K
L
M
N
O



Inverted Flared Fittings

Parker's Inverted Flare Fittings offers a metal-to-metal seal that is internal to the fitting for tighter tube bends. These fittings are listed with UL and meets the functional requirements of SAE J512.

Product Features:

- All brass construction
- UL listed for flammable liquid and gas
- Meets functional requirements of SAE J512
- Steel nut for economy

Applications:

- Refrigerant Lines
- Brake Lines
- Fuel Lines

Compatible Tubing:

- Copper
- Brass
- Aluminum
- Welded Steel Hydraulic Tubing

Markets:

- Air Conditioning
- Marine
- Mobile
- Engines



Specifications:

Temperature Range: -65° to +250° F (-53.8° to 121.1° C)

Pressure Range:

| TUBE SIZE | PSI | bar | TUBE SIZE | PSI | bar |
|-----------|------|-------|-----------|------|------|
| 1/8 | 2800 | 193.0 | 3/8 | 1000 | 68.9 |
| 3/16 | 1900 | 131.0 | 1/2 | 750 | 51.7 |
| 1/4 | 1400 | 96.5 | 5/8 | 650 | 44.8 |
| 5/16 | 1200 | 82.7 | 3/4 | 550 | 37.9 |

Assembly Instructions

1. Cut tubing squarely and clean to remove burrs
2. Place nut onto tube. Place threaded end of nut toward end of tube.
3. Flare tube end with flaring tool to provide 45° flare
4. On thin wall copper, welded or brazed tubing, use double flare to prevent pinch-off or cracked flares
5. Clamp tube flare between nut and nose of fitting body by screwing nut on finger tight. Tighten nut with a wrench an additional 1/4 to 1/2 turn past finger tight for a metal-to-metal seal.



WARNING These products can expose you to chemicals including LEAD which is known to the state of California to cause cancer and birth defects or other reproductive harm. For more information go to www.P65Warnings.ca.gov.

Click here for CADs, Product Specifications or to Configure Parts Online

Nut 41IF

REF. SAE 040110

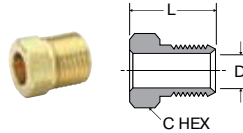

| PART NO. | TUBE SIZE | STRAIGHT THREAD | C HEX | L | D |
|----------|-----------|-----------------|-------|-----|------|
| 41IF-2 | 1/8 | 5/16-28 | 5/16 | .52 | .133 |
| 41IF-3 | 3/16 | 3/8-24 | 3/8 | .56 | .196 |
| 41IF-4 | 1/4 | 7/16-24 | 7/16 | .56 | .259 |
| 41IF-5 | 5/16 | 1/2-20 | 1/2 | .62 | .321 |
| 41IF-6 | 3/8 | 5/8-18 | 5/8 | .66 | .384 |
| 41IF-8 | 1/2 | 3/4-18 | 3/4 | .74 | .508 |
| 41IF-10 | 5/8 | 7/8-18 | 7/8 | .80 | .633 |

Union 42IFHD

REF. SAE 040101

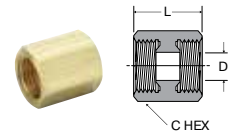

| PART NO. | TUBE SIZE | STRAIGHT THREAD | C HEX | L | D |
|----------|-----------|-----------------|-------|-----|------|
| 42IFHD-2 | 1/8 | 5/16-28 | 13/32 | .60 | .078 |
| 42IFHD-3 | 3/16 | 3/8-24 | 15/32 | .63 | .125 |
| 42IFHD-4 | 1/4 | 7/16-24 | 17/32 | .63 | .189 |
| 42IFHD-5 | 5/16 | 1/2-20 | 19/32 | .71 | .220 |
| 42IFHD-6 | 3/8 | 5/8-18 | 3/4 | .81 | .282 |
| 42IFHD-8 | 1/2 | 3/4-18 | 29/32 | .92 | .407 |

Steel Nut-Zinc 41IFS

REF. SAE 040110

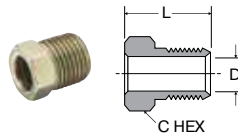

| PART NO. | TUBE SIZE | STRAIGHT THREAD | C HEX | L | D |
|----------|-----------|-----------------|-------|-----|------|
| 41IFS-3 | 3/16 | 3/8-24 | 3/8 | .56 | .196 |

Female Connector 46IFHD

REF. SAE 040103

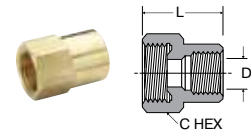

| PART NO. | TUBE SIZE | PIPE THREAD | STRAIGHT THREAD | C HEX | L | FLOW DIA. D |
|------------|-----------|-------------|-----------------|-------|------|-------------|
| 46IFHD-3-2 | 3/16 | 1/8 | 3/8-24 | 1/2 | .76 | .125 |
| 46IFHD-4-2 | 1/4 | 1/8 | 7/16-24 | 17/32 | .78 | .189 |
| 46IFHD-5-2 | 5/16 | 1/8 | 1/2-20 | 19/32 | .79 | .220 |
| 46IFHD-6-4 | 3/8 | 1/4 | 5/8-18 | 3/4 | 1.04 | .282 |
| 46IFHD-8-6 | 1/2 | 3/8 | 3/4-18 | 29/32 | 1.10 | .407 |

Piloted Nut 41IFF for Single Flared Tubing

REF. SAE 040110

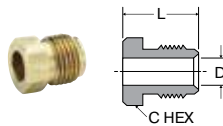

| PART NO. | TUBE SIZE | STRAIGHT THREAD | C HEX | L | D |
|----------|-----------|-----------------|-------|-----|------|
| 41IFF-2 | 1/8 | 5/16-28 | 5/16 | .52 | .133 |
| 41IFF-3 | 3/16 | 3/8-24 | 3/8 | .56 | .196 |
| 41IFF-4 | 1/4 | 7/16-24 | 7/16 | .56 | .259 |
| 41IFF-5 | 5/16 | 1/2-20 | 1/2 | .62 | .321 |
| 41IFF-6 | 3/8 | 5/8-18 | 5/8 | .66 | .384 |
| 41IFF-8 | 1/2 | 3/4-18 | 3/4 | .74 | .508 |

Male Connector 48IFHD

REF. SAE 040102

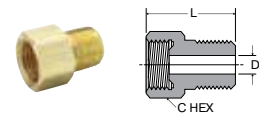

| PART NO. | TUBE SIZE | PIPE THREAD | STRAIGHT THREAD | C HEX | L | FLOW DIA. D |
|--------------|-----------|-------------|-----------------|--------|------|-------------|
| 48IFHD-2-2 | 1/8 | 1/8 | 5/16-28 | 13/32 | .63 | .078 |
| 48IFHD-3-2 | 3/16 | 1/8 | 3/8-24 | 15/32 | .70 | .125 |
| 48IFHD-4-2 | 1/4 | 1/8 | 7/16-24 | 17/32 | .74 | .189 |
| 48IFHD-4-4 | 1/4 | 1/4 | 7/16-24 | 9/16 | .89 | .189 |
| 48IFHD-5-2 | 5/16 | 1/8 | 1/2-20 | 19/32 | .79 | .220 |
| 48IFHD-5-4 | 5/16 | 1/4 | 1/2-20 | 19/32 | .98 | .220 |
| 48IFHD-6-2 | 3/8 | 1/8 | 5/8-18 | 3/4 | .89 | .220 |
| 48IFHD-6-4 | 3/8 | 1/4 | 5/8-18 | 3/4 | 1.03 | .282 |
| 48IFHD-6-6 | 3/8 | 3/8 | 5/8-18 | 3/4 | 1.03 | .282 |
| 48IFHD-8-4 | 1/2 | 1/4 | 3/4-18 | 29/32 | 1.07 | .346 |
| 48IFHD-8-6 | 1/2 | 3/8 | 3/4-18 | 29/32 | 1.07 | .407 |
| 48IFHD-8-8 | 1/2 | 1/2 | 3/4-18 | 29/32 | 1.26 | .407 |
| 48IFHD-10-8 | 5/8 | 1/2 | 7/8-18 | 1-1/16 | 1.32 | .533 |
| 48IFHD-12-12 | 3/4 | 3/4 | 1-1/16-16 | 1 1/4 | 1.38 | .626 |

WARNING These products can expose you to chemicals including LEAD which is known to the state of California to cause cancer and birth defects or other reproductive harm. For more information go to www.P65Warnings.ca.gov.



- A
- B
- C
- D
- E
- F
- G
- H
- I
- J
- K
- L
- M
- N
- O

[Click here for CADs, Product Specifications or to Configure Parts Online](#)

- A
- B
- C
- D
- E
- F
- G
- H
- I
- J
- K
- L
- M
- N
- O

Union Tee 244IFHD

REF. SAE 040401

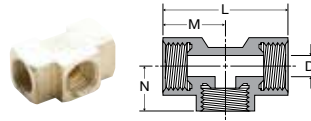

| PART NO. | TUBE SIZE | STRAIGHT THREAD | L | M | N | FLOW DIA. D |
|------------|-----------|-----------------|------|-----|-----|-------------|
| 244IFHD-3 | 3/16 | 3/8-24 | 1.10 | .55 | .39 | .125 |
| 244IFHD-4 | 1/4 | 7/16-24 | 1.13 | .56 | .42 | .189 |
| 244IFHD-5 | 5/16 | 1/2-20 | 1.26 | .63 | .45 | .220 |
| 244IFHD-6 | 3/8 | 5/8-18 | 1.48 | .74 | .56 | .282 |
| 244IFHD-8* | 1/2 | 3/4-18 | 1.76 | .88 | .67 | .407 |

*Does not meet SAE or UL.

Male Branch Tee 245IFHD

REF. SAE 040425

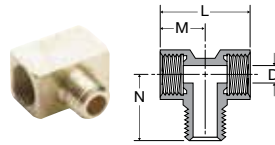

| PART NO. | TUBE SIZE | PIPE THREAD | STRAIGHT THREAD | L | M | N | FLOW DIA. D |
|-------------|-----------|-------------|-----------------|------|-----|-----|-------------|
| 245IFHD-4-2 | 1/4 | 1/8 | 7/16-24 | .85 | .43 | .64 | .189 |
| 245IFHD-6-4 | 3/8 | 1/4 | 5/8-18 | 1.17 | .58 | .94 | .282 |

Male Elbow 249IFHD-249IF

REF. SAE 040202

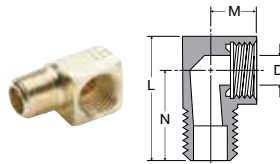

| PART NO. | TUBE SIZE | PIPE THREAD | STRAIGHT THREAD | L | M | N | FLOW DIA. D |
|---------------|-----------|-------------|-----------------|------|-----|------|-------------|
| 249IFHD-2-2 | 1/8 | 1/8 | 5/16-28 | .79 | .27 | .58 | .078 |
| 249IFHD-3-2 | 3/16 | 1/8 | 3/8-24 | .85 | .27 | .61 | .125 |
| 249IFHD-4-2† | 1/4 | 1/8 | 7/16-24 | .92 | .33 | .65 | .189 |
| 249IFHD-4-4 | 1/4 | 1/4 | 7/16-24 | 1.10 | .28 | .82 | .189 |
| 249IFHD-5-4 | 5/16 | 1/4 | 1/2-20 | 1.16 | .45 | .86 | .220 |
| 249IFHD-6-2† | 3/8 | 1/8 | 5/8-18 | 1.13 | .53 | .76 | .220 |
| 249IF-6-4† | 3/8 | 1/4 | 5/8-18 | 1.26 | .45 | .92 | .282 |
| 249IFHD-6-4 | 3/8 | 1/4 | 5/8-18 | 1.32 | .53 | .95 | .282 |
| 249IFHD-6-6 | 3/8 | 3/8 | 5/8-18 | 1.32 | .50 | .94 | .282 |
| 249IFHD-8-4* | 1/2 | 1/4 | 3/4-18 | 1.48 | .59 | 1.02 | .407 |
| 249IF-8-6* | 1/2 | 3/8 | 3/4-18 | 1.42 | .53 | .99 | .407 |
| 249IFHD-8-6† | 1/2 | 3/8 | 3/4-18 | 1.48 | .59 | 1.02 | .407 |
| 249IFHD-8-8 | 1/2 | 1/2 | 3/4-18 | 1.67 | .66 | 1.22 | .407 |
| 249IFHD-10-6* | 5/8 | 3/8 | 7/8-18 | 1.62 | .67 | 1.09 | .531 |
| 249IFHD-10-8* | 5/8 | 1/2 | 7/8-18 | 1.82 | .67 | 1.29 | .533 |

† Light Duty Series

+ For these parts the pipe thread through hole is smaller than the through hole on the flare end.

Female Elbow 250IFHD

REF. SAE 040203

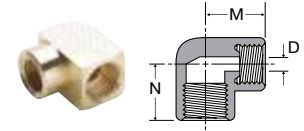

| PART NO. | TUBE SIZE | PIPE THREAD | STRAIGHT THREAD | M | N | FLOW DIA. D |
|-------------|-----------|-------------|-----------------|-----|-----|-------------|
| 250IFHD-3-2 | 3/16 | 1/8 | 3/8-24 | .50 | .49 | .125 |
| 250IFHD-4-2 | 1/4 | 1/8 | 7/16-24 | .53 | .53 | .189 |
| 250IFHD-5-2 | 5/16 | 1/8 | 1/2-20 | .59 | .59 | .220 |
| 250IFHD-6-4 | 3/8 | 1/4 | 5/8-18 | .67 | .68 | .282 |

Male Run Tee 251IFHD

REF. SAE 040424

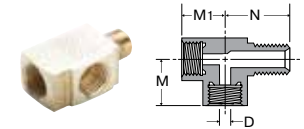

| PART NO. | TUBE SIZE | PIPE THREAD | STRAIGHT THREAD | M | M1 | N | FLOW DIA. D |
|-------------|-----------|-------------|-----------------|-----|-----|------|-------------|
| 251IFHD-3-2 | 3/16 | 1/8 | 3/8-24 | .39 | .53 | .72 | .125 |
| 251IFHD-5-2 | 5/16 | 1/8 | 1/2-20 | .45 | .62 | .85 | .220 |
| 251IFHD-6-4 | 3/8 | 1/4 | 5/8-18 | .56 | .75 | 1.08 | .282 |

Female Branch Tee 252IFHD

REF. SAE 040427

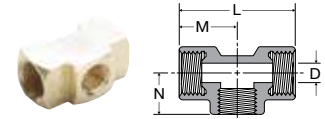

| PART NO. | TUBE SIZE | PIPE THREAD | STRAIGHT THREAD | L | M | N | FLOW DIA. D |
|-------------|-----------|-------------|-----------------|------|-----|-----|-------------|
| 252IFHD-5-2 | 5/16 | 1/8 | 1/2-20 | 1.26 | .63 | .45 | .220 |
| 252IFHD-6-4 | 3/8 | 1/4 | 5/8-18 | 1.48 | .74 | .56 | .282 |

Union Elbow 255IFHD

| PART NO. | TUBE SIZE | STRAIGHT THREAD | M | FLOW DIA. D |
|------------|-----------|-----------------|-----|-------------|
| 255IFHD-4* | 1/4 | 7/16-24 | .55 | .189 |

*Does not meet SAE or UL.

45° Elbow 259IFHD

REF. SAE 040302

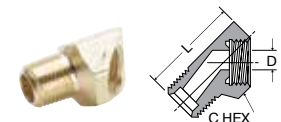

| PART NO. | TUBE SIZE | PIPE THREAD | STRAIGHT THREAD | C HEX | L | FLOW DIA. D |
|--------------|-----------|-------------|-----------------|--------|------|-------------|
| 259IFHD-3-2 | 3/16 | 1/8 | 3/8-24 | 17/32 | .88 | .125 |
| 259IFHD-4-2 | 1/4 | 1/8 | 7/16-24 | 9/16 | .94 | .189 |
| 259IFHD-5-2 | 5/16 | 1/8 | 1/2-20 | 5/8 | 1.00 | .220 |
| 259IFHD-5-4 | 5/16 | 1/4 | 1/2-20 | 5/8 | 1.16 | .220 |
| 259IFHD-6-4* | 3/8 | 1/4 | 5/8-18 | 13/16 | 1.34 | .282 |
| 259IFHD-8-6 | 1/2 | 3/8 | 3/4-18 | 7/8 | 1.44 | .407 |
| 259IFHD-10-8 | 5/8 | 1/2 | 7/8-18 | 1-1/16 | 1.75 | .533 |

*Does not meet SAE or UL.

WARNING These products can expose you to chemicals including LEAD which is known to the state of California to cause cancer and birth defects or other reproductive harm. For more information go to www.P65Warnings.ca.gov.





Access Valves

Parker's Access Valves are designed to offer convenient, low cost access ports for refrigeration service. Access valves may be installed in any position on either high or low side for quick testing, pressure checking, purging or charging.

Product Features:

- All brass construction
- 1/4" SAE male flare access ports
- Finger tight quick seal caps
- Access valves with pipe connections have internal ODS solder cups

Markets:

- Refrigeration
- Air Conditioning

Applications:

- Pressure Testing
- Purging
- Charging Refrigeration Lines

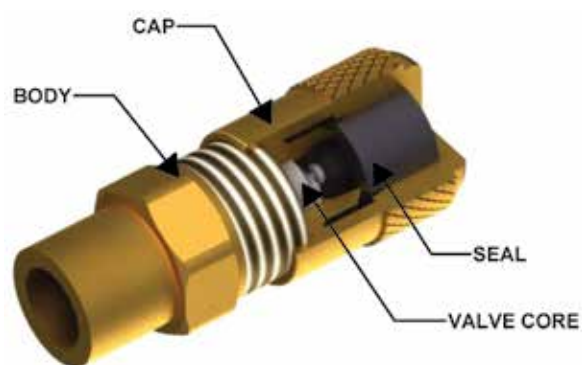

Specifications:

Pressure Range Up to 500 PSI (34.3 bar)

Temperature Range -20° to +220° F (-28.8° to +104.4° C)

Compatible Tubing:

- Copper

WARNING These products can expose you to chemicals including LEAD which is known to the state of California to cause cancer and birth defects or other reproductive harm. For more information go to www.P65Warnings.ca.gov.



[Click here for CADs, Product Specifications or to Configure Parts Online](#)

- A
- B
- C
- D
- E
- F
- G
- H
- I
- J
- K
- L
- M
- N
- O

Extended Copper Tube AVUSE



| PART NO. | CONNECTION SIZE |
|----------|-----------------|
| AVUSE-2 | 1/8" O.D. TUBE |
| AVUSE-3 | 3/16" O.D. TUBE |
| AVUSE-4 | 1/4" O.D. TUBE |
| AVUSE-6 | 3/8" O.D. TUBE |
| AVUSE-8 | 1/2" O.D. TUBE |

Product comes with valve core loose and should be torqued after brazing to ARI 720 standard.

Solder Tee AVTS



| PART NO. | CONNECTION SIZE |
|----------|---|
| AVTS-4 | 1/4" O.D. TUBE OR 3/8" SOLDER FITTING/SWAGED TUBE |
| AVTS-6 | 3/8" O.D. TUBE OR 1/2" SOLDER FITTING/SWAGED TUBE |
| AVTS-8 | 1/2" O.D. TUBE |

Product comes with valve core loose and should be torqued after brazing to ARI 720 standard.

Full Union AVU2



| PART NO. | CONNECTION SIZE |
|----------|--|
| AVU2-4 | 1/4" O.D. FLARE TUBE WITH FORGED FLARE NUT |

Bulkhead Union AVU2BH



| PART NO. | CONNECTION SIZE |
|----------|---|
| AVU2BH-4 | 1/4" BULKHEAD ACCESS X 1/4" SAE WITH FORGED NUT |

Bulkhead Solder Union AVUS3BH



| PART NO. | CONNECTION SIZE |
|-----------|----------------------------------|
| AVUS3BH-4 | 1/4" BULKHEAD ACCESS X 3 WAY ODS |

Product comes with valve core loose and should be torqued after brazing to ARI 720 standard.

Male Connector AVU1



| PART NO. | CONNECTION SIZE |
|----------|-------------------------------------|
| AVU1-2 | 1/8" MALE PIPE OR 1/4" O.D. SOLDER |
| AVU1-4 | 1/4" MALE PIPE OR 5/16" O.D. SOLDER |

Product comes with valve core loose and should be torqued after brazing to ARI 720 standard.

Access Valve Assembly AVUIFI



| PART NO. | CONNECTION SIZE |
|----------|---|
| AVUIFI-4 | 7/16-20 SAE STRAIGHT THREAD O-RING PORT |

Note: Standard o-ring is neoprene. Consult Brass Products Division for optional o-rings



Forged Male Elbow AVE1

| PART NO. | CONNECTION SIZE |
|----------|------------------------------------|
| AVE1-2 | 1/8" MALE PIPE OR 1/4" O.D. SOLDER |

Product comes with valve core loose and should be torqued after brazing to ARI 720 standard.

Forged Male Run Tee AVT3



| PART NO. | CONNECTION SIZE |
|----------|--|
| AVT3-2 | 1/8" MALE PIPE OR 1/4" O.D. SOLDER ON RUN X 1/4" ACCESS ON RUN AND BRANCH WITH ONE CORE AND CAP |
| AVT3-4 | 1/4" MALE PIPE OR 5/16" O.D. SOLDER ON RUN X 1/4" ACCESS ON RUN AND BRANCH WITH ONE CORE AND CAP |

Product comes with valve core loose and should be torqued after brazing to ARI 720 standard.

Forged Male Cross AVC1



| PART NO. | CONNECTION SIZE |
|----------|---|
| AVC1-4 | 1/4" MALE PIPE OR 5/16" O.D. SOLDER X 1/4" ACCESS ON ALL FLARE ENDS WITH ONE CORE AND CAP |

Product comes with valve core loose and should be torqued after brazing to ARI 720 standard.

Female Connector AVUR3



| PART NO. | CONNECTION SIZE |
|----------|--------------------------------------|
| AVUR3-4 | 1/4" FEMALE FLARE WITH COPPER GASKET |

WARNING These products can expose you to chemicals including LEAD which is known to the state of California to cause cancer and birth defects or other reproductive harm. For more information go to www.P65Warnings.ca.gov.

[Click here for CADs, Product Specifications or to Configure Parts Online](#)

3 Way Solder Connector AVUS3



| PART NO. | CONNECTION SIZE |
|----------|---|
| AVUS3-40 | FOR 3/16" O.D. TUBE OR 1/4" AND 3/8" SOLDER FITTING/SWAGED TUBE |

Product comes with valve core loose and should be torqued after brazing to ARI 720 standard.

Straight Solder Connector AVUS



| PART NO. | CONNECTION SIZE |
|----------|--|
| AVUS-42 | 1/8" O.D. TUBE OR 1/4" SOLDER FITTING/SWAGED TUBE |
| AVUS-43 | 3/16" O.D. TUBE OR 1/4" SOLDER FITTING/SWAGED TUBE |
| AVUS-44 | 1/4" O.D. TUBE OR 3/8" SOLDER FITTING/SWAGED TUBE |
| AVUS-46 | 3/8" O.D. TUBE OR 1/2" SOLDER FITTING/SWAGED TUBE |

Product comes with valve core loose and should be torqued after brazing to ARI 720 standard.

Swivel Connector AVUS4D



| PART NO. | CONNECTION SIZE |
|----------|--|
| AVUS4D-4 | 1/4" FORGED FEMALE FLARE SWIVEL NUT WITH DEPRESSOR |

Forged Female Run Swivel Tee AVTS4



| PART NO. | CONNECTION SIZE |
|----------|---|
| AVTS4-4 | 1/4" FEMALE FLARE SWIVEL X 1/4" ACCESS ON BOTH RUN AND BRANCH |
| AVTS4D-4 | 1/4" FEMALE FLARE SWIVEL ON RUN WITH DEPRESSOR X 1/4" ACCESS ON BOTH RUN AND BRANCH |

Forged Female Branch Tee AVTS6



| PART NO. | CONNECTION SIZE |
|----------|--|
| AVTS6-4 | 1/4" FEMALE FLARE SWIVEL X 1/4" ACCESS ON BOTH ENDS |
| AVTS6D-4 | 1/4" FEMALE FLARE SWIVEL ON BRANCH WITH DEPRESSOR X 1/4" ACCESS ON BOTH ENDS |

Quick Seal Caps 640QSF



| PART NO. | CONNECTION SIZE |
|----------|------------------------------------|
| 640QSF-4 | 1/4" SAE SEAL CAP WITH SEAL GASKET |
| 640QSF-6 | 3/8" SAE SEAL CAP WITH SEAL GASKET |

Quick Seal Cap with Core Remover 640QSFCR



| PART NO. | CONNECTION SIZE |
|------------|--|
| 640QSFCR-4 | 1/4" SAE SEAL CAP CORE REMOVER WITH INTERNAL SEAL GASKET |

Core Remover CR



| PART NO. | CONNECTION SIZE |
|----------|-----------------------|
| CR-001 | STANDARD CORE REMOVER |

Valve Cores VC



| PART NO. | CONNECTION SIZE |
|----------|--|
| VC-001 | REPLACEMENT VALVE CORES FOR ALL 1/4" ACCESS VALVES |

Refrigerant Adapter 88AC



| PART NO. | CONNECTION SIZE |
|----------|--|
| 88AC-8-2 | 1/8" MALE PIPE TO SAE J2197 ACME THREADED MALE CONNECTOR |

Refrigerant Adapter 880AC



| PART NO. | CONNECTION SIZE |
|-----------|---|
| 880AC-8-4 | 1/4" FEMALE SAE FLARE TO SAE J2197 ACME THREADED MALE CONNECTOR |

Refrigerant Adapter 881AC



| PART NO. | CONNECTION SIZE |
|-----------|---|
| 881AC-8-4 | 1/4" SAE MALE FLARE TO SAE J2197 ACME THREADED FEMALE CONNECTOR |

WARNING These products can expose you to chemicals including LEAD which is known to the state of California to cause cancer and birth defects or other reproductive harm. For more information go to www.P65Warnings.ca.gov.



- A
- B
- C
- D
- E
- F
- G
- H
- I
- J
- K
- L
- M
- N
- O



Industrial Barbed Fittings

Dubl-Barb[®] Fittings

Hose Barb Fittings

Pneumatic Hose Fittings



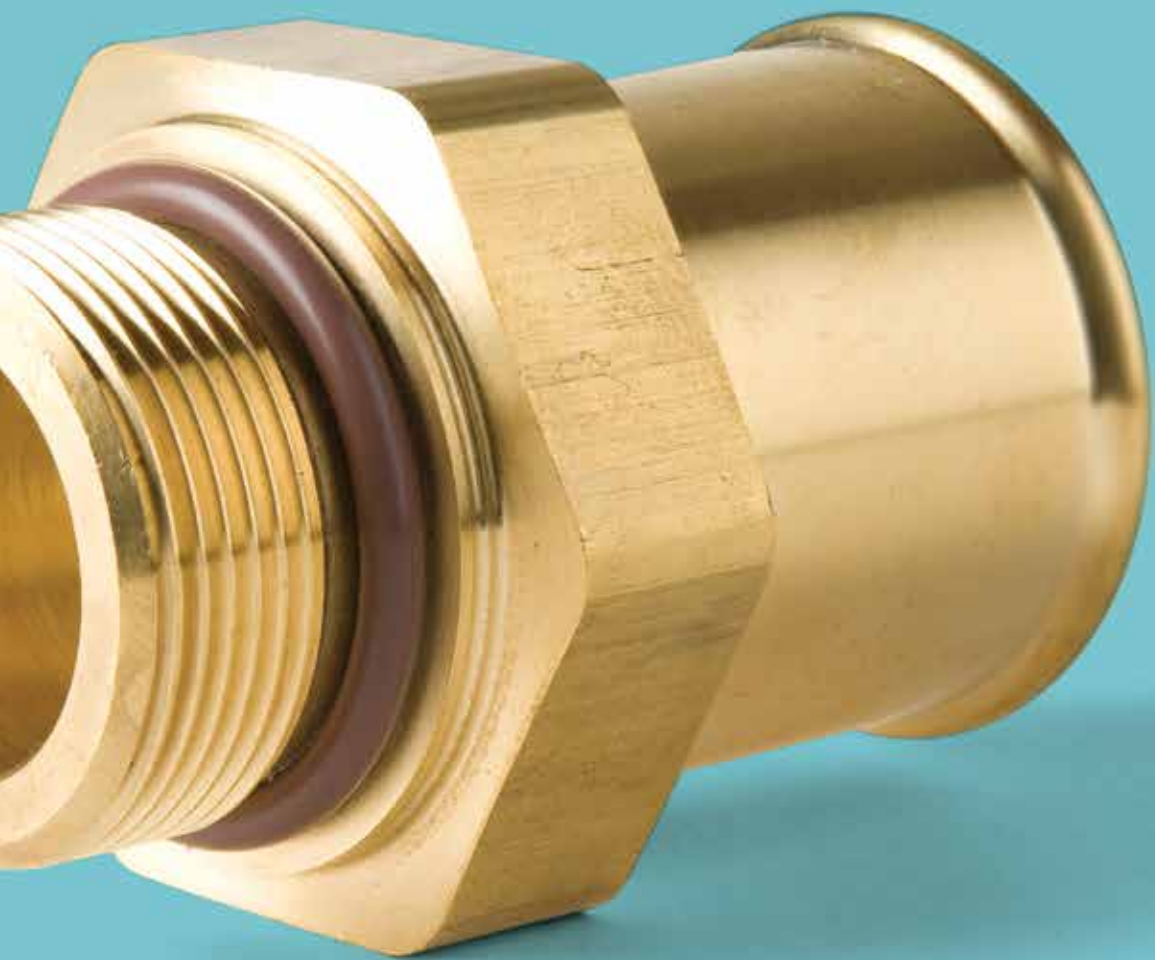







Threaded Fittings

| | | | | | | |
|---|---|--|--|---|--|---|
| 26 Female Connector NPT p. 16  | 27 Male Connector p. 16  | 28 Male Connector NPT p. 17  | 228 Gauge Tee NPT p. 18  | 229 Male Elbow NPT p. 18  | 230 Female Elbow NPT p. 18  | 231 Run Tee NPT p. 18  |
| 232 Branch Tee NPT p. 18  | 237 Female Tee NPT p. 18  | 68HB Male Connector NPT p. 110  | 685HB Male Connector p. 110  | 68HB-X-MIX Male Connector p. 110  | 125HB Male Connector NPT p. 110  | 125HBL Male Connector NPT p. 110  |
| 125HBLSV Swivel Connector NPT p. 111  | 126HBL Female Connector NPT p. 111  | 127HB Ball-End Adapter NPT p. 111  | 129HB Male Elbow NPT p. 111  | 1295HB Male Elbow p. 111  | 139HB 45° Male Elbow NPT p. 112  | 1695HB Male Elbow p. 112  |
| 169HB-X-MIX Male Elbow p. 112  | 1725HB Tee p. 112  | 171HB Run Tee NPT p. 112  | 179HB 45° Male Elbow NPT p. 112  | 1795HB 45° Male Elbow p. 113  | 179HB-X-MIX 45° Male Elbow p. 113  | 269HB Male Elbow p. 113  |
| 279HB 45° Male Elbow p. 113  | 0123 Male Connector BSPT p. 113  | 0136 Metric Hose to BSPT p. 114  | 0191 Metric Hose to BSPP p. 114  | 0931 Metric Hose to BSPP p. 114  | | |

Barb to Barb

| | | | |
|--|---|---|---|
| 22 Union p. 16  | 224 Union Tee p. 17  | 225 Union Elbow p. 17  | 122HBL Union p. 110  |
|--|---|---|---|

Bulkhead Unions

| | |
|---|---|
| 22BH Bulkhead Union p. 16  | 22CABH Bulkhead Union p. 16  |
|---|---|

Adapters

| | | |
|--|---|--|
| 22CA Mixed Union p. 16  | 220 Adapter Tee p. 17  | 238 Solder Connector p. 18  |
|--|---|--|

Swivel

| | |
|---|---|
| 128HBLSV Female Ball-End p. 111  | 146HBLFSV 45° Female Flare p. 112  |
|---|---|

Accessories

| | |
|---|---|
| 20 Plug p. 16  | 97HC Clamp p. 113  |
|---|---|

WARNING These products can expose you to chemicals including NICKEL or LEAD, which are known to the state of California to cause cancer, and LEAD which is known to cause birth defects or other reproductive harm. For more information go to www.P65Warnings.ca.gov.

A
B
C
D
E
F
G
H
I
J
K
L
M
N
O



Dubl-Barb® Fittings

Parker's Dubl-Barb Fittings are an economical one piece, push-on brass barbed fitting that does not require any type of clamp. These fittings are a quick way to connect polyethylene tubing.

Product Features:

- Compact
- One piece
- No clamp required
- Good vibration resistance

Applications:

- Pneumatic Systems
- Climate Control
- Humidifiers
- Filters

Markets:

- Pneumatic
- Environmental control

Compatible Tubing:

- Polyethylene



Specifications:

Pressure Range:

| TUBE SIZE | PSI | bar | TUBE SIZE | PSI | bar |
|-----------|-----|------|-----------|-----|------|
| 5/32 | 150 | 10.3 | 3/8 | 150 | 10.3 |
| 1/4 | 150 | 10.3 | 1/2 | 100 | 6.8 |

Temperature Range:

| TUBE SIZE | TEMPERATURE IN FAHRENHEIT | TEMPERATURE IN CELSIUS |
|-----------|---------------------------|------------------------|
| 5/32 | -65° to +90° F | -53.8° to +32.2° C |
| 1/4 | -65° to +90° F | -53.8° to +32.2° C |
| 3/8 | -65° to +90° F | -53.8° to +32.2° C |
| 1/2 | -65° to +75° F | -53.8° to +23.8° C |

Assembly Instructions

Cut tube squarely and simply push tube over the two barbs



See Parker Legris Fit Kit on p. I12

WARNING These products can expose you to chemicals including LEAD which is known to the state of California to cause cancer and birth defects or other reproductive harm. For more information go to www.P65Warnings.ca.gov.

Click here for CADs, Product Specifications or to Configure Parts Online

- A
- B
- C
- D
- E
- F
- G
- H
- I
- J
- K
- L
- M
- N
- O

Plug 20

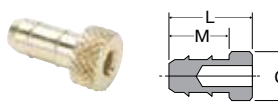

| PART NO. | TUBE O.D. | TUBE I.D. | C DIA. | L | M |
|----------|-----------|-----------|--------|-----|-----|
| 20-4 | 1/4 | .170 | .32 | .56 | .41 |
| 20-6 | 3/8 | .250 | .390 | .68 | .44 |
| 20-8 | 1/2 | .377 | .577 | .81 | .56 |

Plug Adapter 20

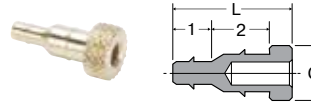

| PART NO. | TUBE O.D. 1 | TUBE I.D. 1 | TUBE O.D. 2 | TUBE I.D. 2 | C DIA. | L |
|-----------|-------------|-------------|-------------|-------------|--------|-----|
| 20-4-5/32 | 5/32 | .096 | 1/4 | .170 | .32 | .65 |

Union 22

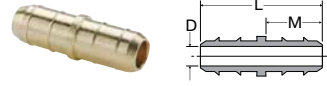

| PART NO. | TUBE O.D. | TUBE I.D. | L | M | FLOW DIA. D |
|----------|-----------|-----------|------|-----|-------------|
| 22-5/32 | 5/32X5/32 | .096X.096 | .59 | .28 | .062 |
| 22-4 | 1/4X1/4 | .170X.170 | .84 | .41 | .120 |
| 22-6 | 3/8X3/8 | .250X.250 | .94 | .44 | .187 |
| 22-8 | 1/2X1/2 | .375X.375 | 1.19 | .56 | .312 |

Union Reducer 22

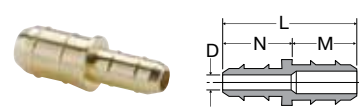

| PART NO. | TUBE O.D. | TUBE I.D. | L | M | N | FLOW DIA. D |
|-----------|-----------|-----------|------|-----|-----|-------------|
| 22-4-5/32 | 1/4X5/32 | .170X.096 | .72 | .41 | .28 | .062 |
| 22-4-6 | 1/4X3/8 | .170X.250 | .88 | .44 | .41 | .120 |
| 22-4-8 | 1/4X1/2 | .170X.375 | 1.06 | .56 | .41 | .120 |
| 22-6-8 | 3/8X1/2 | .250X.375 | 1.06 | .56 | .44 | .187 |

Bulkhead Union 22BH

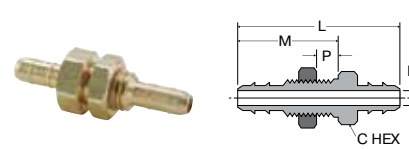

| PART NO. | TUBE O.D. | TUBE I.D. | ST. THD. | C HEX | P MAX. | L | M | FLOW DIA. D | BLKHD HOLE DIA. |
|----------|-----------|-----------|----------|-------|--------|------|------|-------------|-----------------|
| 22BH-4-4 | 1/4 | .170 | 5/16-24 | 7/16 | .219 | 1.38 | .78 | .120 | 5/16 |
| 22BH-6-6 | 3/8 | .250 | 3/8-24 | 7/16 | .375 | 1.63 | 1.00 | .187 | 3/8 |

Union 22CA

Tube to Compress-Align

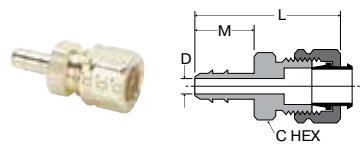

| PART NO. | TUBE O.D. | TUBE I.D. | CA TUBE | C HEX | L | M | FLOW DIA. D |
|----------|-----------|-----------|---------|-------|------|-----|-------------|
| 22CA-4-4 | 1/4 | .170 | 1/4 | 7/16 | 1.15 | .41 | .120 |

Bulkhead Union 22CABH

Tube to Compress-Align

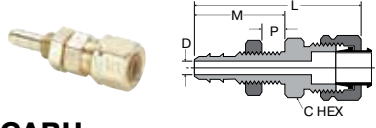

| PART NO. | TUBE O.D. | TUBE I.D. | CA TUBE | ST. THD. | C HEX | P MAX | L | M | FLW DIA. D | BKHD HOLE DIA. |
|------------|-----------|-----------|---------|----------|-------|-------|------|------|------------|----------------|
| 22CABH-4-4 | 1/4 | .170 | 1/4 | 5/16-24 | 7/16 | .219 | 1.53 | .78 | .120 | 5/16 |
| 22CABH-6-6 | 3/8 | .250 | 3/8 | 3/8-24 | 9/16 | .375 | 1.87 | 1.00 | .187 | 3/8 |

Female Connector 26

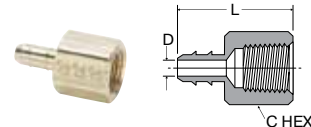

| PART NO. | TUBE O.D. | TUBE I.D. | PIPE THREAD | C HEX | L | FLOW DIA. D |
|-----------|-----------|-----------|-------------|-------|------|-------------|
| 26-5/32-2 | 5/32 | .096 | 1/8 | 1/2 | .79 | .062 |
| 26-4-2 | 1/4 | .170 | 1/8 | 1/2 | .91 | .120 |
| 26-6-2 | 3/8 | .250 | 1/8 | 1/2 | .93 | .187 |
| 26-6-4 | 3/8 | .250 | 1/4 | 11/16 | 1.06 | .187 |

Male Connector 27



| PART NO. | TUBE O.D. | TUBE I.D. | STRAIGHT THREAD | C HEX | L | FLOW DIA. D |
|----------|-----------|-----------|-----------------|-------|-----|-------------|
| 27-1* | 1/8 | .062 | 10-32 | 1/4 | .61 | .052 |
| 27-2* | 1/4 | .125 | 10-32 | 1/4 | .74 | .093 |

*For vinyl tubing only.

WARNING These products can expose you to chemicals including LEAD which is known to the state of California to cause cancer and birth defects or other reproductive harm. For more information go to www.P65Warnings.ca.gov.

[Click here for CADs, Product Specifications or to Configure Parts Online](#)

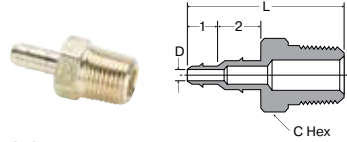

Barb-to-Pipe Adapter 28

| PART NO. | TUBE O.D. 1 | TUBE I.D. 1 | TUBE O.D. 2 | TUBE I.D. 2 | PIPE THD. | C HEX | L | FLOW DIA. D |
|-------------|-------------|-------------|-------------|-------------|-----------|-------|------|-------------|
| 28-4-5/32-2 | 5/32 | .096 | 1/4 | .170 | 1/8 | 7/16 | 1.07 | .062 |

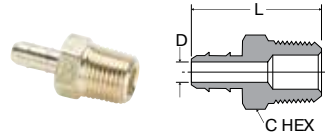

Male Connector 28

| PART NO. | TUBE O.D. | TUBE I.D. | PIPE THREAD | C HEX | L | FLOW DIA. D |
|-------------|-----------|-----------|-------------|-------|------|-------------|
| 28-5/32-2 | 5/32 | .096 | 1/8 | 7/16 | .84 | .062 |
| 28-4-1 | 1/4 | .170 | 1/16 | 3/8 | .93 | .120 |
| 28-4-2 | 1/4 | .170 | 1/8 | 7/16 | .97 | .120 |
| 28-4-4 | 1/4 | .170 | 1/4 | 9/16 | 1.09 | .120 |
| 28-4-10X32* | 1/4 | .170 | 10-32 | 1/4 | .71 | .093 |
| 28-6-2 | 3/8 | .250 | 1/8 | 7/16 | 1.00 | .187 |
| 28-6-4 | 3/8 | .250 | 1/4 | 9/16 | 1.13 | .187 |
| 28-8-4 | 1/2 | .375 | 1/4 | 9/16 | 1.25 | .312 |
| 28-8-6 | 1/2 | .375 | 3/8 | 11/16 | 1.28 | .312 |
| 28-8-8 | 1/2 | .375 | 1/2 | 7/8 | 1.44 | .312 |

*Straight thread

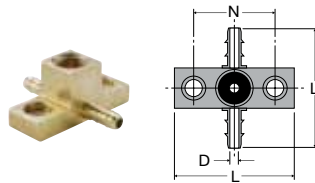

Adapter Tee 220

| PART NO. | TUBE O.D. | TUBE I.D. | PIPE THREAD | L | N | FLOW DIA. D |
|----------|-----------|-----------|-------------|------|------|-------------|
| 220-4-2 | 1/4 | .170 | 1/8 | 1.50 | 1.00 | .120 |

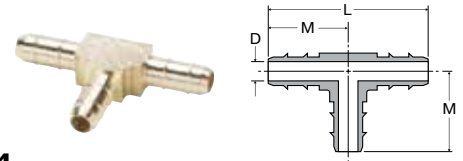

Union Tee 224

| PART NO. | TUBE O.D. | TUBE I.D. | L | M | FLOW DIA. D |
|----------|-----------|-----------|------|-----|-------------|
| 224-5/32 | 5/32 | .096 | 1.00 | .50 | .062 |
| 224-4 | 1/4 | .170 | 1.25 | .63 | .120 |
| 224-6 | 3/8 | .250 | 1.38 | .69 | .187 |
| 224-8 | 1/2 | .375 | 1.63 | .81 | .312 |

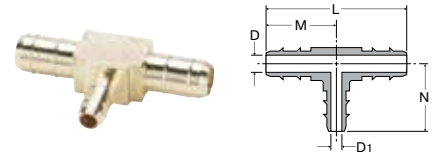

Union Tee 224 Combination Sizes

| PART NO. | TUBE O.D. | TUBE I.D. | L | M | N | FLOW DIA. D | FLOW DIA. D1 |
|--------------|-----------|-----------|------|-----|-----|-------------|--------------|
| 224-4-4-5/32 | 1/4X5/32 | .170X.096 | 1.25 | .63 | .50 | .120 | .062 |
| 224-6-6-5/32 | 3/8X5/32 | .250X.096 | 1.38 | .69 | .50 | .187 | .062 |
| 224-6-6-4 | 3/8X1/4 | .250X.170 | 1.38 | .69 | .62 | .187 | .120 |
| 224-8-8-4 | 1/2X1/4 | .375X.170 | 1.62 | .81 | .65 | .312 | .120 |
| 224-8-8-6 | 1/2X3/8 | .375X.250 | 1.62 | .81 | .69 | .312 | .187 |

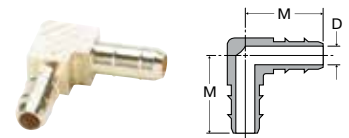

Union Elbow 225

| PART NO. | TUBE O.D. | TUBE I.D. | M | FLOW DIA. D |
|----------|-----------|-----------|-----|-------------|
| 225-5/32 | 5/32 | .096 | .50 | .062 |
| 225-4-4 | 1/4 | .170 | .63 | .120 |
| 225-6-6 | 3/8 | .250 | .69 | .187 |
| 225-8-8 | 1/2 | .375 | .81 | .312 |

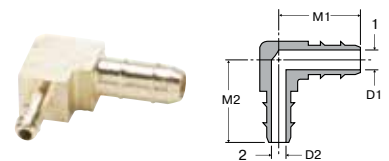

Union Elbow 225 Combination Size

| PART NO. | TUBE O.D. 1 | TUBE O.D. 2 | TUBE I.D. 1 | TUBE I.D. 2 | M1 | M2 | FLOW DIA. D1 | FLOW DIA. D2 |
|------------|-------------|-------------|-------------|-------------|-----|-----|--------------|--------------|
| 225-4-5/32 | 1/4 | 5/32 | .170 | .096 | .63 | .50 | .120 | .062 |

WARNING These products can expose you to chemicals including LEAD which is known to the state of California to cause cancer and birth defects or other reproductive harm. For more information go to www.P65Warnings.ca.gov.



- A
- B
- C
- D
- E
- F
- G
- H
- I
- J
- K
- L
- M
- N
- O

[Click here for CADs, Product Specifications or to Configure Parts Online](#)

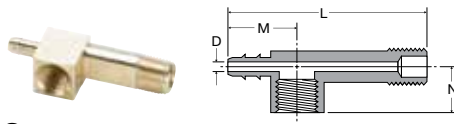

Gauge Tee 228

| PART NO. | TUBE O.D. | TUBE I.D. | PIPE THREAD | L | M | N | FLOW DIA. D |
|----------|-----------|-----------|-------------|------|-----|-----|-------------|
| 228-4-2 | 1/4 | .170 | 1/8 | 1.91 | .66 | .44 | .120 |

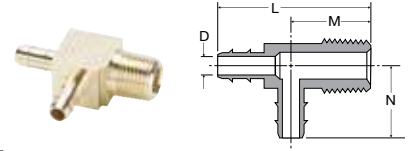

Male Run Tee 231

| PART NO. | TUBE O.D. | TUBE I.D. | PIPE THREAD | L | M | N | FLOW DIA. D |
|----------|-----------|-----------|-------------|------|-----|-----|-------------|
| 231-4-2 | 1/4 | .170 | 1/8 | 1.28 | .66 | .69 | .120 |
| 231-6-2 | 3/8 | .250 | 1/8 | 1.38 | .69 | .69 | .187 |
| 231-6-4 | 3/8 | .250 | 1/4 | 1.44 | .75 | .75 | .187 |

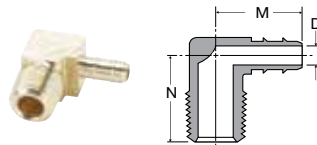

Male Elbow 229

| PART NO. | TUBE O.D. | TUBE I.D. | PIPE THREAD | M | N | FLOW DIA. D |
|------------|-----------|-----------|-------------|-----|-----|-------------|
| 229-5/32-2 | 5/32 | .096 | 1/8 | .56 | .63 | .062 |
| 229-4-1 | 1/4 | .170 | 1/16 | .62 | .60 | .120 |
| 229-4-2 | 1/4 | .170 | 1/8 | .69 | .63 | .120 |
| 229-4-4 | 1/4 | .170 | 1/4 | .72 | .72 | .120 |
| 229-6-2 | 3/8 | .250 | 1/8 | .69 | .69 | .187 |
| 229-6-4 | 3/8 | .250 | 1/4 | .75 | .75 | .187 |
| 229-8-4 | 1/2 | .375 | 1/4 | .94 | .74 | .312 |
| 229-8-6 | 1/2 | .375 | 3/8 | .94 | .81 | .312 |

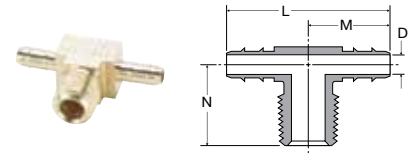

Male Branch Tee 232

| PART NO. | TUBE O.D. | TUBE I.D. | PIPE THREAD | L | M | N | FLOW DIA. D |
|----------|-----------|-----------|-------------|------|-----|-----|-------------|
| 232-4-1 | 1/4 | .170 | 1/16 | 1.33 | .66 | .65 | .120 |
| 232-4-2 | 1/4 | .170 | 1/8 | 1.38 | .69 | .66 | .120 |
| 232-6-2 | 3/8 | .250 | 1/8 | 1.38 | .69 | .69 | .187 |
| 232-6-4 | 3/8 | .250 | 1/4 | 1.50 | .75 | .75 | .187 |

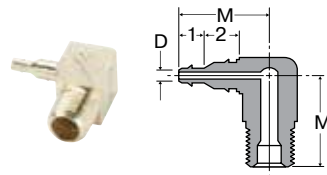

90° Elbow Barb Adapter 229

| PART NO. | TUBE O.D. 1 | TUBE I.D. 1 | TUBE O.D. 2 | TUBE I.D. 2 | PIPE THREAD | M | FLOW DIA. D |
|--------------|-------------|-------------|-------------|-------------|-------------|-----|-------------|
| 229-4-5/32-2 | 5/32 | .096 | 1/4 | .170 | 1/8 | .78 | .062 |

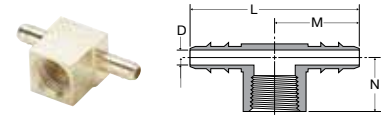

Female Branch Tee 237

| PART NO. | TUBE O.D. | TUBE I.D. | PIPE THREAD | L | M | N | FLOW DIA. D |
|------------|-----------|-----------|-------------|------|-----|-----|-------------|
| 237-5/32-2 | 5/32 | .096 | 1/8 | 1.06 | .53 | .44 | .062 |
| 237-4-2 | 1/4 | .170 | 1/8 | 1.34 | .67 | .49 | .120 |

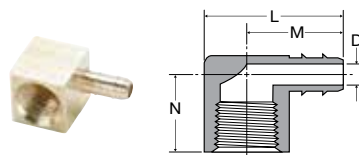

Female Elbow 230

| PART NO. | TUBE O.D. | TUBE I.D. | PIPE THREAD | L | M | N | FLOW DIA. D |
|----------|-----------|-----------|-------------|------|-----|-----|-------------|
| 230-4-2 | 1/4 | .170 | 1/8 | .91 | .66 | .44 | .120 |
| 230-6-4 | 3/8 | .250 | 1/4 | 1.12 | .78 | .63 | .187 |

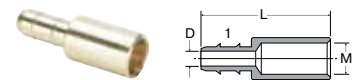

Solder Connector 238

| PART NO. | TUBE O.D. 1 | TUBE I.D. 1 | L | M | FLOW DIA. D |
|----------|-------------|-------------|-----|-----|-------------|
| 238-4-4 | 1/4 | .170 | .91 | .25 | .120 |

WARNING These products can expose you to chemicals including LEAD which is known to the state of California to cause cancer and birth defects or other reproductive harm. For more information go to www.P65Warnings.ca.gov.



Hose Barb Fittings

Parker's Hose Barb Fittings are an economical choice for general purpose fluid handling and pneumatics. Manufactured in both regular hose barb and beaded hose barb styles. Fittings are intended for use with 97HC hose clamps, similar type clamp or a crimped ferrule.

Product Features:

- All brass construction
- Fluorocarbon O-rings
- NPTF, SAE straight thread, metric thread ends
- Reusable
- Clamp required

Compatible Tubing:

- Rubber Hose
- GPH Hose

Markets:

- Industrial
- Construction
- Heavy duty truck
- Mobile

Applications:

- Air Lines
- Water Line
- Cooling Lines

Specifications:

Pressure Range Up to 150 PSI (10.3 bar)

Temperature Range -40° to +160° F (-40° to +71.1° C)



Assembly Instructions

1. Cut hose cleanly and squarely to length.
2. Slide clamp on hose.
3. Lubricate hose. Push hose on fitting until bottomed against stop ring or hex.
4. Position hose clamp as shown and secure with a screwdriver or wrench. Maintain "A" dimension for proper clamp positioning.



| HOSE SIZE | HOSE CLAMP | A |
|-----------|------------|-----|
| 3/16 | 97 HC-3 | 1/4 |
| 1/4 | 97 HC-3 | 1/4 |
| 5/16 | 97 HC-6 | 1/4 |
| 3/8 | 97 HC-6 | 1/8 |
| 1/2 | 97 HC-8 | 1/8 |
| 5/8 | 97 HC-12 | 1/8 |
| 3/4 | 97 HC-12 | 1/8 |

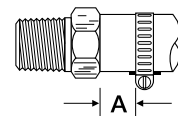

WARNING These products can expose you to chemicals including NICKEL or LEAD, which are known to the state of California to cause cancer, and LEAD which is known to cause birth defects or other reproductive harm. For more information go to www.P65Warnings.ca.gov.



Click here for CADs, Product Specifications or to Configure Parts Online

- A
- B
- C
- D
- E
- F
- G
- H
- I
- J
- K
- L
- M
- N
- O

Beaded Hose Barb to Male Pipe 68HB

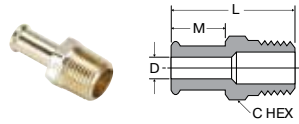

| PART NO. | I.D. HOSE SIZE | PIPE THREAD | C HEX | L | M | FLOW DIA. D |
|------------|----------------|-------------|--------|------|------|-------------|
| 68HB-6-6 | 3/8 | 3/8 | 11/16 | 1.53 | .78 | .281 |
| 68HB-8-4 | 1/2 | 1/4 | 5/8 | 1.56 | .78 | .375 |
| 68HB-8-6 | 1/2 | 3/8 | 11/16 | 1.53 | .78 | .406 |
| 68HB-8-8 | 1/2 | 1/2 | 7/8 | 1.84 | .78 | .406 |
| 68HB-10-6 | 5/8 | 3/8 | 3/4 | 1.62 | .88 | .501 |
| 68HB-10-8 | 5/8 | 1/2 | 7/8 | 1.92 | .88 | .501 |
| 68HB-12-8 | 3/4 | 1/2 | 7/8 | 1.98 | .88 | .564 |
| 68HB-12-12 | 3/4 | 3/4 | 1 1/16 | 2.04 | .97 | .625 |
| 68HB-16-12 | 1 | 3/4 | 1 1/8 | 2.12 | 1.00 | .750 |
| 68HB-16-16 | 1 | 1 | 1.38 | 2.31 | 1.00 | .812 |

Beaded Hose Barb to SAE Straight Thread 685HB

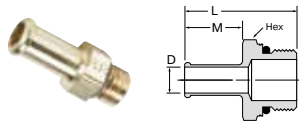

| PART NO. | I.D. HOSE SIZE | STRAIGHT THREAD | C HEX | L | M | FLOW DIA. D |
|-------------|----------------|-----------------|-------|------|-----|-------------|
| 685HB-4-4 | 1/4 | 7/16-20 | 9/16 | 1.40 | .78 | .18 |
| 685HB-6-4 | 3/8 | 7/16-20 | 9/16 | 1.39 | .78 | .18 |
| 685HB-8-8 | 1/2 | 3/4-16 | 7/8 | 1.48 | .78 | .40 |
| 685HB-10-8 | 5/8 | 3/4-16 | 7/8 | 1.56 | .78 | .40 |
| 685HB-12-8 | 3/4 | 3/4-16 | 7/8 | 1.75 | .97 | .40 |
| 685HB-12-12 | 3/4 | 1 1/16-12 | 1 1/4 | 1.82 | .97 | .62 |
| 685HB-16-8 | 1 | 3/4-16 | 1 1/8 | 1.79 | .97 | .40 |
| 685HB-16-12 | 1 | 1 1/16-12 | 1 1/4 | 1.99 | .97 | .62 |

Note: Fluorocarbon o-ring is standard

Hose Barb to Metric Adaptor 68HB-X-MIX

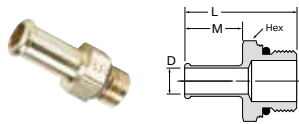

| PART NUMBER | I.D. HOSE SIZE | METRIC THREAD | HEX | L | M | D |
|-------------|----------------|---------------|-------|------|-----|-----|
| 68HB-6-MI12 | 3/8 | M12 X 1.5 | 11/16 | 1.50 | .78 | .24 |
| 68HB-6-MI14 | 3/8 | M14 1.5 | 3/4 | 1.51 | .78 | .29 |
| 68HB-8-MI12 | 1/2 | M12 X 1.5 | 11/16 | 1.50 | .78 | .24 |

Note: Fluorocarbon o-ring is standard

Hose Mender 122HBL

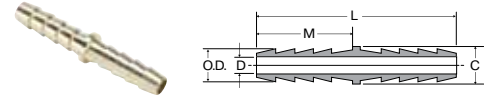

| PART NO. | I.D. HOSE SIZE | C DIA. | L | M | O.D. | FLOW DIA. D |
|-----------|----------------|--------|------|-----|------|-------------|
| 122HB-3 | 3/16 | 5/16 | 1.44 | .69 | .227 | .125 |
| 122HBL-4 | 1/4 | 3/8 | 2.00 | .97 | .290 | .187 |
| 122HBL-5 | 5/16 | 7/16 | 2.00 | .97 | .353 | .250 |
| 122HBL-6 | 3/8 | 1/2 | 2.00 | .97 | .415 | .281 |
| 122HBL-8 | 1/2 | 5/8 | 2.00 | .97 | .530 | .375 |
| 122HBL-12 | 3/4 | 7/8 | 2.00 | .97 | .790 | .562 |

Hose Barb to Male Pipe 125HB

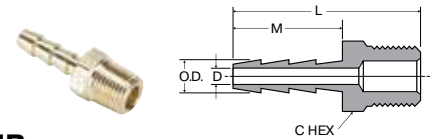

| PART NO. | I.D. HOSE SIZE | PIPE THREAD | C HEX | L | M | O.D. | FLOW DIA. D |
|-----------|----------------|-------------|-------|------|-----|------|-------------|
| 125HB-2-2 | 1/8 | 1/8 | 7/16 | 1.07 | .50 | .185 | .093 |
| 125HB-3-2 | 3/16 | 1/8 | 7/16 | 1.25 | .69 | .227 | .125 |
| 125HB-3-4 | 3/16 | 1/4 | 9/16 | 1.44 | .69 | .227 | .125 |

Hose Barb to Male Pipe 125HBL

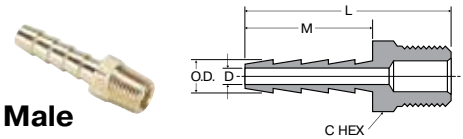

| PART NO. | I.D. HOSE SIZE | PIPE THREAD | C HEX | L | M | O.D. | FLOW DIA. D |
|--------------|----------------|-------------|--------|------|------|------|-------------|
| 125HBL-4-2 | 1/4 | 1/8 | 7/16 | 1.54 | .97 | .290 | .187 |
| 125HBL-4-4 | 1/4 | 1/4 | 9/16 | 1.72 | .97 | .290 | .187 |
| 125HBL-4-6 | 1/4 | 3/8 | 11/16 | 1.77 | .97 | .290 | .187 |
| 125HBL-5-2 | 5/16 | 1/8 | 7/16 | 1.54 | .97 | .353 | .250 |
| 125HBL-5-4 | 5/16 | 1/4 | 9/16 | 1.72 | .97 | .353 | .250 |
| 125HBL-5-6 | 5/16 | 3/8 | 11/16 | 1.77 | .97 | .353 | .250 |
| 125HBL-6-2 | 3/8 | 1/8 | 7/16 | 1.54 | .97 | .415 | .281 |
| 125HBL-6-4 | 3/8 | 1/4 | 9/16 | 1.72 | .97 | .415 | .281 |
| 125HBL-6-6 | 3/8 | 3/8 | 11/16 | 1.77 | .97 | .415 | .281 |
| 125HBL-6-8 | 3/8 | 1/2 | 7/8 | 1.97 | .97 | .415 | .281 |
| 125HBL-8-4 | 1/2 | 1/4 | 9/16 | 1.72 | .97 | .530 | .375 |
| 125HBL-8-6 | 1/2 | 3/8 | 11/16 | 1.77 | .97 | .530 | .375 |
| 125HBL-8-8 | 1/2 | 1/2 | 7/8 | 1.97 | .97 | .530 | .375 |
| 125HBL-8-12 | 1/2 | 3/4 | 1-1/16 | 1.98 | .97 | .530 | .375 |
| 125HBL-10-6 | 5/8 | 3/8 | 11/16 | 1.77 | .97 | .645 | .468 |
| 125HBL-10-8 | 5/8 | 1/2 | 7/8 | 1.97 | .97 | .645 | .468 |
| 125HBL-10-12 | 5/8 | 3/4 | 1-1/16 | 1.98 | .97 | .645 | .468 |
| 125HBL-12-8 | 3/4 | 1/2 | 7/8 | 1.97 | .97 | .790 | .562 |
| 125HBL-12-12 | 3/4 | 3/4 | 1-1/16 | 1.98 | .97 | .790 | .562 |
| 125HBL-16-12 | 1 | 3/4 | 1-1/16 | 2.18 | 1.17 | 1.02 | .750 |
| 125HBL-16-16 | 1 | 1 | 1-3/8 | 2.36 | 1.17 | 1.02 | .875 |

WARNING These products can expose you to chemicals including NICKEL or LEAD, which are known to the state of California to cause cancer, and LEAD which is known to cause birth defects or other reproductive harm. For more information go to www.P65Warnings.ca.gov.



Click here for CADs, Product Specifications or to Configure Parts Online

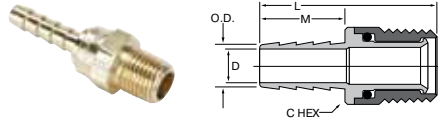

Male Swivel Hose Barb 125HBLSV

| PART NO. | I.D. HOSE SIZE | PIPE THREAD | C HEX | L | M | O.D. | FLOW DIA. D |
|--------------|----------------|-------------|-------|------|-----|------|-------------|
| 125HBLSV-4-4 | 1/4 | 1/4 | 9/16 | 1.73 | .97 | .290 | .187 |
| 125HBLSV-6-4 | 3/8 | 1/4 | 9/16 | 1.73 | .97 | .415 | .212 |
| 125HBLSV-6-6 | 3/8 | 3/8 | 11/16 | 1.80 | .97 | .415 | .280 |
| 125HBLSV-8-8 | 1/2 | 1/2 | 7/8 | 2.01 | .97 | .530 | .375 |

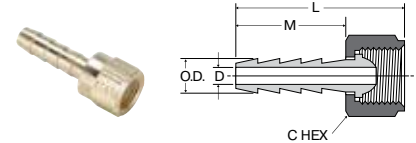

Hose Barb to Swivel Female Ball-End 128HBLSV

| PART NO. | I.D. HOSE SIZE | FEMALE N. P.S.M. THREAD | C HEX | L | M | O.D. | FLOW DIA. D |
|--------------|----------------|-------------------------|-------|------|-----|------|-------------|
| 128HBLSV-4-4 | 1/4 | 1/4 | 5/8 | 1.50 | .97 | .290 | .187 |
| 128HBLSV-5-4 | 5/16 | 1/4 | 5/8 | 1.50 | .97 | .353 | .250 |
| 128HBLSV-6-4 | 3/8 | 1/4 | 5/8 | 1.63 | .97 | .415 | .250 |
| 128HBLSV-6-6 | 3/8 | 3/8 | 3/4 | 1.50 | .97 | .415 | .281 |
| 128HBLSV-8-8 | 1/2 | 1/2 | 29/32 | 1.52 | .97 | .530 | .375 |

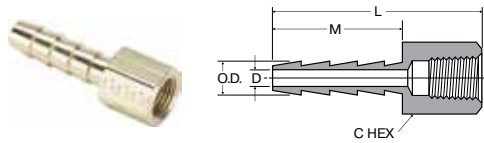

Hose Barb to Female Pipe 126HBL

| PART NO. | I.D. HOSE SIZE | PIPE THREAD | C HEX | L | M | O.D. | FLOW DIA. D |
|--------------|----------------|-------------|-------|------|-----|------|-------------|
| 126HBL-4-2 | 1/4 | 1/8 | 1/2 | 1.47 | .97 | .290 | .187 |
| 126HBL-4-4 | 1/4 | 1/4 | 11/16 | 1.66 | .97 | .290 | .187 |
| 126HBL-5-4 | 5/16 | 1/4 | 11/16 | 1.58 | .97 | .353 | .250 |
| 126HBL-6-2 | 3/8 | 1/8 | 1/2 | 1.47 | .97 | .415 | .281 |
| 126HBL-6-4 | 3/8 | 1/4 | 11/16 | 1.66 | .97 | .415 | .281 |
| 126HBL-6-6 | 3/8 | 3/8 | 13/16 | 1.69 | .97 | .415 | .281 |
| 126HBL-8-6 | 1/2 | 3/8 | 13/16 | 1.69 | .97 | .530 | .375 |
| 126HBL-8-8 | 1/2 | 1/2 | 1 | 1.73 | .97 | .530 | .375 |
| 126HBL-12-12 | 3/4 | 3/4 | 1-1/4 | 1.92 | .97 | .790 | .562 |

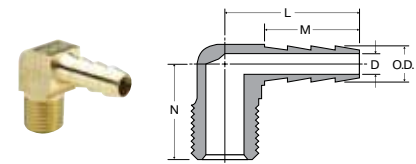

Hose Barb 90° Elbow to Male Pipe 129HB

| PART NO. | I.D. HOSE SIZE | PIPE THREAD | L | M | N | O.D. | FLOW DIA. D |
|-------------|----------------|-------------|------|-----|------|------|-------------|
| 129HB-3-2 | 3/16 | 1/8 | .97 | .69 | .66 | .227 | .173 |
| 129HB-4-2 | 1/4 | 1/8 | 1.04 | .76 | .66 | .290 | .187 |
| 129HB-4-4 | 1/4 | 1/4 | 1.06 | .76 | .82 | .290 | .187 |
| 129HB-4-6 | 1/4 | 3/8 | 1.19 | .76 | .84 | .290 | .187 |
| 129HB-5-2 | 5/16 | 1/8 | 1.06 | .76 | .66 | .353 | .234 |
| 129HB-5-4 | 5/16 | 1/4 | 1.12 | .76 | .84 | .353 | .234 |
| 129HB-5-6 | 5/16 | 3/8 | 1.19 | .76 | .84 | .353 | .234 |
| 129HB-6-2 | 3/8 | 1/8 | 1.32 | .97 | .75 | .415 | .219 |
| 129HB-6-4 | 3/8 | 1/4 | 1.32 | .97 | .94 | .415 | .281 |
| 129HB-6-6 | 3/8 | 3/8 | 1.50 | .97 | 1.06 | .415 | .281 |
| 129HB-6-8 | 3/8 | 1/2 | 1.52 | .97 | 1.25 | .415 | .281 |
| 129HB-8-4 | 1/2 | 1/4 | 1.53 | .97 | 1.06 | .530 | .375 |
| 129HB-8-6 | 1/2 | 3/8 | 1.53 | .97 | 1.06 | .530 | .375 |
| 129HB-8-8 | 1/2 | 1/2 | 1.53 | .97 | 1.25 | .530 | .375 |
| 129HB-12-12 | 3/4 | 3/4 | 1.33 | .79 | 1.27 | .790 | .562 |

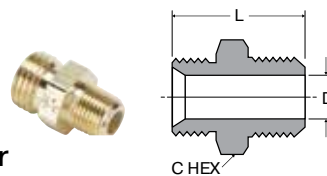

Ball-End Joint Adapter to Male Pipe 127HB

For use with 128HBLSV

| PART NO. | MALE N. P.S.M. THREAD | MALE N. P.T. THREAD | C HEX | L | FLOW DIA. D |
|-----------|-----------------------|---------------------|-------|------|-------------|
| 127HB-4-2 | 1/4 | 1/8 | 9/16 | .91 | .219 |
| 127HB-4-4 | 1/4 | 1/4 | 9/16 | 1.10 | .281 |
| 127HB-6-4 | 3/8 | 1/4 | 11/16 | 1.10 | .312 |
| 127HB-6-6 | 3/8 | 3/8 | 11/16 | 1.15 | .406 |
| 127HB-8-6 | 1/2 | 3/8 | 7/8 | 1.25 | .406 |
| 127HB-8-8 | 1/2 | 1/2 | 7/8 | 1.50 | .531 |

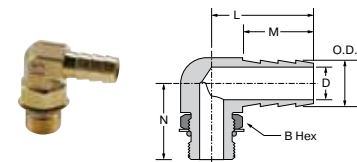

Hose Barb Elbow to SAE Straight Thread 1295HB

| PART NO. | I.D. HOSE SIZE | STRAIGHT THREAD | B HEX | L | M | N | O.D. | FLOW DIA. D |
|------------|----------------|-----------------|-------|------|-----|------|------|-------------|
| 1295HB-6-6 | 3/8 | 9/16-18 | 11/16 | 1.10 | .76 | 1.10 | .42 | .280 |

Note: Fluorocarbon o-ring is standard

WARNING These products can expose you to chemicals including NICKEL or LEAD, which are known to the state of California to cause cancer, and LEAD which is known to cause birth defects or other reproductive harm. For more information go to www.P65Warnings.ca.gov.

- A
- B
- C
- D
- E
- F
- G
- H
- I
- J
- K
- L
- M
- N
- O

Click here for CADs, Product Specifications or to Configure Parts Online

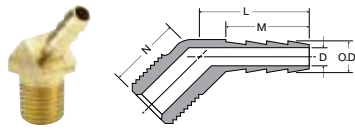

Hose Barb 45° Elbow to Male Pipe 139HB

| PART NO. | I.D. HOSE SIZE | PIPE THREAD | L | M | N | O.D. | FLOW DIA. D |
|-----------|----------------|-------------|------|-----|-----|------|-------------|
| 139HB-4-2 | 1/4 | 1/8 | .91 | .76 | .68 | .290 | .187 |
| 139HB-4-4 | 1/4 | 1/4 | 1.00 | .76 | .68 | .290 | .187 |
| 139HB-6-4 | 3/8 | 1/4 | 1.00 | .76 | .68 | .415 | .281 |

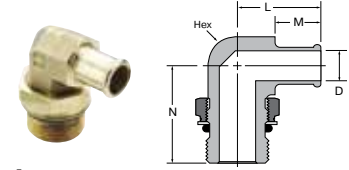

Beaded Elbow to Metric Adaptor 169HB-X-MIX

| PART NUMBER | HOSE SIZE | METRIC THREAD | HEX | L | M | N | D |
|---------------|-----------|---------------|--------|------|-----|------|-----|
| 169HB-10-MI27 | 5/8 | M27 X 2.0 | 7/8 | 1.41 | .78 | 1.63 | .50 |
| 169HB-16-MI27 | 1 | M27 X 2.0 | 1 | 1.67 | .97 | 1.68 | .71 |
| 169HB-16-MI33 | 1 | M33 X 2.0 | 1 5/16 | 1.75 | .97 | 1.90 | .84 |

Note: Fluorocarbon o-ring is standard

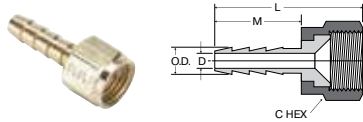

Hose Barb to Swivel 45° Female Flare 146HBLFSV

| PART NO. | I.D. HOSE SIZE | STRAIGHT THREAD | C HEX | L | M | O.D. | FLOW DIA. D |
|---------------|----------------|-----------------|-------|------|-----|------|-------------|
| 146HBLFSV-4-4 | 1/4 | 7/16-20 | 9/16 | 1.55 | .97 | .290 | .187 |
| 146HBLFSV-4-6 | 1/4 | 5/8-18 | 3/4 | 1.72 | .97 | .290 | .187 |
| 146HBLFSV-6-6 | 3/8 | 5/8-18 | 3/4 | 1.72 | .97 | .415 | .281 |

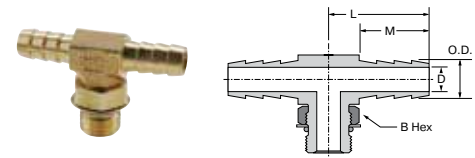

Hose Barb Tee to SAE Straight Thread 1725HB

| PART NO. | I.D. HOSE SIZE | STRAIGHT THREAD | B HEX | L | M | O.D. | FLOW DIA. D |
|------------|----------------|-----------------|-------|------|-----|------|-------------|
| 1725HB-6-6 | 3/8 | 9/16-18 | 11/16 | 1.10 | .76 | .420 | .280 |

Note: Fluorocarbon o-ring is standard

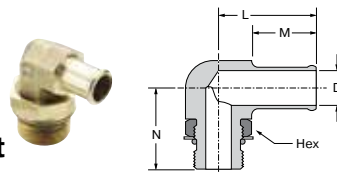

Beaded Hose Barb Elbow to SAE Straight Thread 1695HB

| PART NUMBER | HOSE SIZE | STRAIGHT THREAD | HEX | L | M | N | D |
|--------------|-----------|-----------------|-------|------|-----|------|-----|
| 1695HB-6-4 | 3/8 | 7/16-20 | 9/16 | 1.09 | .78 | 1.10 | .18 |
| 1695HB-8-6 | 1/2 | 9/16-18 | 9/16 | 1.10 | .78 | 1.11 | .30 |
| 1695HB-8-8 | 1/2 | 3/4-16 | 7/8 | 1.28 | .78 | 1.42 | .40 |
| 1695HB-10-8 | 5/8 | 3/4-16 | 7/8 | 1.47 | .88 | 1.47 | .40 |
| 1695HB-10-10 | 5/8 | 7/8-14 | 1 | 1.41 | .88 | 1.60 | .50 |
| 1695HB-12-8 | 3/4 | 3/4-16 | 7/8 | 1.47 | .97 | 1.47 | .40 |
| 1695HB-12-10 | 3/4 | 7/8-14 | 1 | 1.60 | .97 | 1.62 | .50 |
| 1695HB-12-12 | 3/4 | 1 1/16-12 | 1 | 1.60 | .97 | 1.64 | .62 |
| 1695HB-16-12 | 1 | 1 1/16-12 | 1 1/4 | 1.60 | .97 | 1.75 | .60 |

Note: Fluorocarbon o-ring is standard

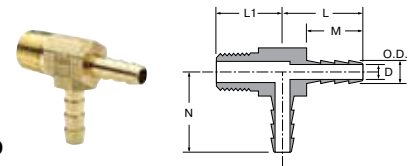

Hose Barb Tee to Male Pipe 171HB

| PART NO. | I.D. HOSE SIZE | PIPE THREAD | L | L1 | M | N | O.D. | FLOW DIA. D |
|-----------|----------------|-------------|------|-----|-----|------|------|-------------|
| 171HB-4-4 | 1/4 | 1/4 | 1.10 | .85 | .76 | 1.10 | .290 | .187 |

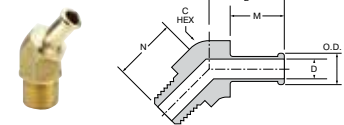

Beaded Hose Barb 45° Elbow Tube to Male Pipe 179HB

| PART NO. | I.D. HOSE SIZE | NPTF THREAD | C HEX | L | M | N | O.D. | FLOW DIA. D |
|------------|----------------|-------------|-------|------|-----|------|------|-------------|
| 179HB-6-4 | 3/8 | 1/4-18 | .75 | 1.09 | .78 | .93 | .45 | .28 |
| 179HB-6-6 | 3/8 | 3/8-18 | .75 | 1.09 | .78 | .93 | .45 | .28 |
| 179HB-10-8 | 5/8 | 1/2-14 | .81 | 1.19 | .78 | 1.13 | .70 | .50 |
| 179HB-12-8 | 3/4 | 1/2-14 | .81 | 1.19 | .78 | 1.13 | .83 | .56 |

WARNING These products can expose you to chemicals including NICKEL or LEAD, which are known to the state of California to cause cancer, and LEAD which is known to cause birth defects or other reproductive harm. For more information go to www.P65Warnings.ca.gov.



Click here for CADs, Product Specifications or to Configure Parts Online

Beaded Hose Barb 45° Elbow Tube to Straight Thread 1795HB

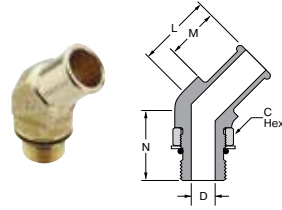

| PART NO. | I.D. HOSE SIZE | STRAIGHT THREAD | C HEX | L | M | N | FLOW DIA. D |
|--------------|----------------|-----------------|-------|------|-----|------|-------------|
| 1795HB-8-8 | 1/2 | 3/4-16 | 7/8 | 1.12 | .78 | 1.16 | .400 |
| 1795HB-10-8 | 5/8 | 3/4-16 | 7/8 | 1.22 | .88 | 1.16 | .398 |
| 1795HB-12-8 | 3/4 | 3/4-16 | 7/8 | 1.22 | .88 | 1.16 | .398 |
| 1795HB-12-12 | 3/4 | 1 1/16-12 | 1 1/4 | 1.35 | .97 | 1.65 | .620 |
| 1795HB-16-12 | 1 | 1 1/16-12 | 1 1/4 | 1.38 | .97 | 1.47 | .620 |

Note: Fluorocarbon o-ring is standard

Stainless Steel Worm Drive Clamp 97HC

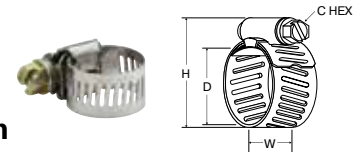

| PART NO. | D MAX. | D MIN. | C HEX | H MAX. | W |
|----------|--------|--------|-------|--------|-----|
| 97HC-3 | .62 | .25 | .25 | 1.00 | .31 |
| 97HC-6 | .87 | .38 | .31 | 1.40 | .50 |
| 97HC-8 | 1.00 | .44 | .31 | 1.53 | .50 |
| 97HC-12 | 1.25 | .50 | .31 | 1.80 | .50 |

Beaded Hose Barb 45° Elbow to Metric Thread 179HB-X-MIX

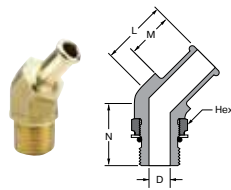

| PART NUMBER | HOSE SIZE | METRIC THREAD | HEX | L | M | N | D |
|---------------|-----------|---------------|--------|------|-----|------|-----|
| 179HB-12-MI18 | 3/4 | M18 X 1.5 | 13/16 | 1.15 | .78 | 1.16 | .44 |
| 179HB-16-MI27 | 1 | M27 X 2.0 | 1 1/16 | 1.51 | .97 | 1.71 | .71 |

Note: Fluorocarbon o-ring is standard

Beaded Hose Barb 90° Elbow Tube to Male Pipe 269HB

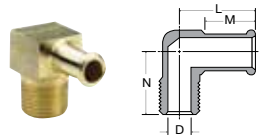

| PART NO. | I.D. HOSE SIZE | PIPE THREAD | L | M | N | FLOW DIA. D |
|-------------|----------------|-------------|------|-----|------|-------------|
| 269HB-6-6 | 3/8 | 3/8 | 1.19 | .78 | .88 | .281 |
| 269HB-8-4 | 1/2 | 1/4 | 1.16 | .78 | .99 | .310 |
| 269HB-8-6 | 1/2 | 3/8 | 1.16 | .78 | 1.08 | .406 |
| 269HB-8-8 | 1/2 | 1/2 | 1.28 | .78 | 1.25 | .406 |
| 269HB-10-4 | 5/8 | 1/4 | 1.13 | .78 | .99 | .312 |
| 269HB-10-6 | 5/8 | 3/8 | 1.16 | .78 | .99 | .406 |
| 269HB-10-8 | 5/8 | 1/2 | 1.28 | .78 | 1.25 | .501 |
| 269HB-12-8 | 3/4 | 1/2 | 1.28 | .78 | 1.25 | .563 |
| 269HB-12-12 | 3/4 | 3/4 | 1.33 | .78 | 1.27 | .625 |

Beaded Hose Barb 45° Elbow Tube to Male Pipe 279HB

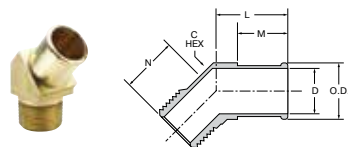

| PART NO. | I.D. HOSE SIZE | NPTF THREAD | C HEX | L | M | N | O.D. | FLOW DIA. D |
|-------------|----------------|-------------|-------|------|-----|------|------|-------------|
| 279HB-16-12 | 1 | 3/4-14 | 1.12 | 1.38 | .97 | 1.13 | 1.06 | .720 |

0123 Barbed Adapter for Rubber Hose BSPT

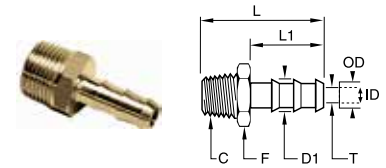

| PART NO. | D MM | C BSPT | D1 MM | F MM | L MM | L1 MM | T MIN MM | WT. KG |
|------------|------|--------|-------|------|------|-------|----------|--------|
| 0123 04 10 | 4 | R1/8 | 6 | 10 | 34 | 22.5 | 3.3 | .008 |
| 0123 06 10 | 6 | R1/8 | 8 | 10 | 34 | 22.5 | 5 | .009 |
| 0123 07 10 | 7 | R1/8 | 9 | 10 | 34 | 22.5 | 5 | .009 |
| 0123 07 13 | 7 | R1/4 | 9 | 14 | 38.5 | 22.5 | 6 | .018 |
| 0123 07 17 | 7 | R3/8 | 9 | 17 | 39 | 22.5 | 6 | .023 |
| 0123 10 10 | 10 | R1/8 | 12.2 | 13 | 34 | 22.5 | 5 | .014 |
| 0123 10 13 | 10 | R1/4 | 12.2 | 14 | 38.5 | 22.5 | 7 | .021 |
| 0123 10 17 | 10 | R3/8 | 12.2 | 17 | 39 | 22.5 | 9.5 | .023 |
| 0123 12 17 | 12 | R3/8 | 14 | 17 | 46 | 29.5 | 11 | .026 |
| 0123 13 13 | 13 | R1/4 | 15 | 17 | 45.5 | 29.5 | 7 | .027 |
| 0123 13 17 | 13 | R3/8 | 15 | 17 | 46 | 29.5 | 11 | .027 |
| 0123 13 21 | 13 | R1/2 | 15 | 22 | 50.5 | 29.5 | 12 | .047 |
| 0123 16 17 | 16 | R3/8 | 18.5 | 19 | 54.5 | 38 | 11 | .040 |
| 0123 16 21 | 16 | R1/2 | 18.5 | 22 | 59 | 38 | 14 | .056 |
| 0123 16 27 | 16 | R3/4 | 18.5 | 27 | 62 | 38 | 15 | .082 |
| 0123 19 17 | 19 | R3/8 | 21.5 | 22 | 54.5 | 38 | 11 | .046 |
| 0123 19 21 | 19 | R1/2 | 21.5 | 22 | 59 | 38 | 14 | .058 |
| 0123 19 27 | 19 | R3/4 | 21.5 | 27 | 62 | 38 | 18 | .083 |
| 0123 25 27 | 25 | R3/4 | 26.7 | 27 | 62 | 38 | 18 | .083 |
| 0123 25 34 | 25 | R1 | 27 | 36 | 65 | 38 | 24 | .124 |
| 0123 32 34 | 32 | R1 | 34.5 | 36 | 70 | 43 | 24 | .144 |

WARNING These products can expose you to chemicals including NICKEL or LEAD, which are known to the state of California to cause cancer, and LEAD which is known to cause birth defects or other reproductive harm. For more information go to www.P65Warnings.ca.gov.



[Click here for CADs, Product Specifications or to Configure Parts Online](#)

- A
- B
- C
- D
- E
- F
- G
- H
- I
- J
- K
- L
- M
- N
- O

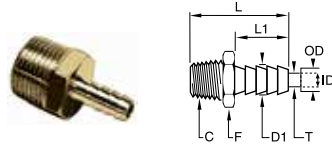

0136 Barbed Adapter for Nylon Tube BSPT

| PART NO. | D MM | C BSPT | D1 MM | F MM | L MM | L1 MM | T MIN MM | WT. KG |
|------------|------|--------|-------|------|------|-------|----------|--------|
| 0136 06 10 | 6 | R1/8 | 6.4 | 10 | 26.5 | 15 | 4 | .007 |
| 0136 06 13 | 6 | R1/4 | 6.4 | 14 | 31 | 15 | 4 | .015 |
| 0136 06 17 | 6 | R3/8 | 6.4 | 17 | 31.5 | 15 | 4 | .020 |
| 0136 08 13 | 8 | R1/4 | 8.4 | 14 | 31 | 15 | 6 | .016 |
| 0136 08 17 | 8 | R3/8 | 8.4 | 17 | 31.5 | 15 | 6 | .020 |
| 0136 08 21 | 8 | R1/2 | 8.4 | 22 | 36 | 15 | 6 | .039 |
| 0136 10 13 | 10 | R1/4 | 10.7 | 14 | 36 | 20 | 7 | .019 |
| 0136 10 17 | 10 | R3/8 | 10.7 | 17 | 36.5 | 20 | 8 | .023 |
| 0136 10 21 | 10 | R1/2 | 10.7 | 22 | 41 | 20 | 8 | .040 |
| 0136 12 13 | 12 | R1/4 | 12.7 | 14 | 36 | 20 | 7 | .019 |
| 0136 12 17 | 12 | R3/8 | 12.7 | 17 | 36.5 | 20 | 10 | .023 |
| 0136 12 21 | 12 | R1/2 | 12.7 | 22 | 41 | 20 | 10 | .042 |
| 0136 12 27 | 12 | R3/4 | 12.7 | 27 | 44 | 20 | 10 | .072 |
| 0136 13 17 | 13 | R3/8 | 13.7 | 17 | 36.5 | 20 | 11 | .023 |
| 0136 13 21 | 13 | R1/2 | 13.7 | 22 | 41 | 20 | 11 | .041 |
| 0136 13 27 | 13 | R3/4 | 13.7 | 27 | 44 | 20 | 11 | .071 |

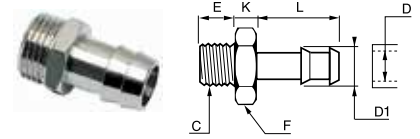

0931 Nickel Plated Hose to Male BSPP

| PART NO. | D MM | C BSPP | D1 MM | E MM | F MM | K MM | L MM | WT. KG |
|------------|------|--------|-------|------|------|------|------|--------|
| 0931 06 10 | 6 | G1/8 | 7 | 6 | 12 | 4 | 20 | 0.008 |
| 0931 06 13 | 6 | G1/4 | 7 | 8 | 14 | 5 | 20 | 0.013 |
| 0931 07 10 | 7 | G1/8 | 8 | 6 | 12 | 4 | 20 | 0.009 |
| 0931 07 13 | 7 | G1/4 | 8 | 8 | 14 | 5 | 20 | 0.017 |
| 0931 07 17 | 7 | G3/8 | 8 | 9 | 19 | 5 | 20 | 0.022 |
| 0931 08 10 | 8 | G1/8 | 9 | 6 | 12 | 4 | 20 | 0.009 |
| 0931 08 13 | 8 | G1/4 | 9 | 8 | 14 | 5 | 20 | 0.014 |
| 0931 08 17 | 8 | G3/8 | 9 | 9 | 19 | 5 | 20 | 0.022 |
| 0931 10 13 | 10 | G1/4 | 12 | 8 | 14 | 5 | 20 | 0.016 |
| 0931 10 17 | 10 | G3/8 | 12 | 9 | 19 | 5 | 20 | 0.023 |
| 0931 10 21 | 10 | G1/2 | 12 | 10 | 22 | 6 | 22 | 0.032 |
| 0931 15 17 | 15 | G3/8 | 17 | 9 | 19 | 6 | 24 | 0.030 |
| 0931 15 21 | 15 | G1/2 | 17 | 10 | 22 | 6 | 24 | 0.036 |
| 0931 18 21 | 18 | G1/2 | 20 | 10 | 22 | 6 | 24 | 0.043 |

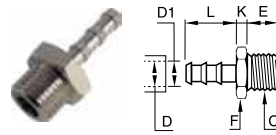

0191 Nickel Plated Hose to Male BSPP

| PART NO. | D MM | C BSPP | D1 MM | E MM | F MM | K MM | L MM | WT. KG |
|------------|------|--------|-------|------|------|------|------|--------|
| 0191 04 13 | 4 | G1/4 | 6 | 9.5 | 17 | 5 | 22.5 | .019 |
| 0191 07 13 | 7 | G1/4 | 9 | 9.5 | 17 | 5 | 22.5 | .021 |
| 0191 07 21 | 7 | G1/2 | 9 | 11 | 27 | 7 | 29.5 | .065 |
| 0191 10 13 | 10 | G1/4 | 12.2 | 9.5 | 17 | 5 | 22.5 | .021 |
| 0191 10 21 | 10 | G1/2 | 12.2 | 11 | 27 | 7 | 29.5 | .060 |
| 0191 13 13 | 13 | G1/4 | 15.2 | 9.5 | 17 | 5 | 22.5 | .023 |
| 0191 13 21 | 13 | G1/2 | 15.2 | 11 | 27 | 7 | 29.5 | .058 |
| 0191 16 21 | 16 | G1/2 | 18.5 | 11 | 27 | 7 | 36.5 | .069 |

WARNING These products can expose you to chemicals including NICKEL or LEAD, which are known to the state of California to cause cancer, and LEAD which is known to cause birth defects or other reproductive harm. For more information go to www.P65Warnings.ca.gov.



[Click here for CADs, Product Specifications or to Configure Parts Online](#)



Pneumatic Hose Fittings

Parker's Pneumatic Hose Fittings are manufactured from heavy duty brass for dependable, leak-free usage.

Product Features:

- All Brass Construction

Markets:

- Industrial Pneumatics
- Industrial Automation
- Construction & Carpentry

Applications:

- Air Hose
- Blow Guns
- Pneumatic Assembly Tools
- Construction & carpentry tools
- Manufacturing air drops

Specifications:

Pressure Range Dependent on hose end connection

Temperature Range Dependent on hose end connection

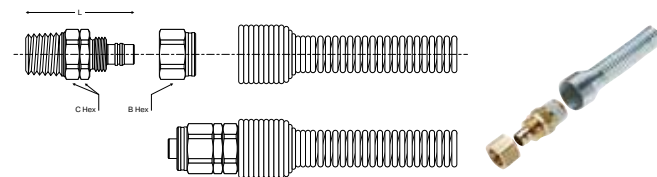
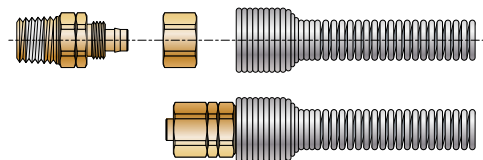

Field Attachable Fittings (Nylon Hose)

| PART NO. | THD SIZE (NPT) | HOSE SIZE (IN) | B HEX (IN) | C HEX (IN) | L (IN) |
|----------|----------------|----------------|------------|------------|--------|
| 01300 | 1/4 | 3/16 | | | |
| 01400-XX | 1/4 | 1/4 | 9/16 | 9/16 | 1.37 |
| 01500 | 1/4 | 5/16 | 9/16 | 5/8 | 1.56 |
| 01640 | 1/4 | 3/8 | 9/16 | 11/16 | 1.48 |
| 01600 | 3/8 | 3/8 | 11/16 | 11/16 | 1.53 |
| 01700 | 1/2 | 1/2 | 15/16 | 15/16 | 1.93 |

Includes Nut & Spring Guard

WARNING These products can expose you to chemicals including NICKEL or LEAD, which are known to the state of California to cause cancer, and LEAD which is known to cause birth defects or other reproductive harm. For more information go to www.P65Warnings.ca.gov.





Industrial Adapters

Pipe Fittings

Metric Adapters

Nickel Plated Metric Adapters

ISO Port Adapters

Garden Hose Fittings





Male to Male

215PN

Close Nipple
Pipe to Pipe
p. J9



215PNL

Long Nipple
Pipe to Pipe
p. J9



216P

Hex Nipple
Pipe to Pipe
p. J10



1204P

Male Elbow
Pipe to Pipe
p. J11



0152

Union Elbow
BSPT to BSPT
p. J14



0121

Hex Nipple
NPT to BSPT
p. J15



0929

3 Piece Adapter
BSPT to BSPT
p. J15



0914/0922

Union Elbow
BSPT to BSPT
p. J17



0927

Union Tee
BSPT to BSPT
p. J18



0900

Hex Nipple
BSPT to BSPT
p. J19



0901

Hex Nipple
BSPP to BSPP
p. J20



0192

Hex Nipple
BSPT to BSPP
p. J20



Male to Female

209P

Bushing
Pipe to Pipe
p. J8



222P

Adapter
Pipe to Pipe
p. J10



1202P-2202P

Street Elbow
Pipe to Pipe
p. J11



2224P

Male Branch Tee
Pipe to Pipe
p. J11



2225P

Street Tee
Pipe to Pipe
p. J11



2214P

45° Street Elbow
Pipe to Pipe
p. J12



F3HG

Adapter - Male
BSPT to NPT
p. J14



0164

Female BSPP
NPT to BSPP
p. J14



0144

Street Elbow
BSPT to BSPP
p. J14



0158

Male Branch Tee
BSPT to BSPP
p. J15



0163

Bushing
BSPT to BSPP
p. J16



0169

Adapter
BSPP to BSPP
p. J16



0913/0921

Street Elbow
BSPT to BSPP
p. J17



0911

Y Connector
BSPT to BSPP
p. J17



0916/0923

Male Branch Tee
BSPT to BSPP
p. J18



0917/0924

Male Run Tee
BSPT to BSPP
p. J18



0928

Female Branch Tee
BSPT to BSPP
p. J18



0909

Cross
BSPT to BSPP
p. J18



0903

Adapter Reducer
BSPP to BSPP
p. J18



0904

Bushing
BSPT to BSPP
p. J19



0905

Bushing
BSPP to BSPP
p. J19



0906

Adapter
BSPP to BSPP
p. J19



0907

Extended Adapter
BSPP to BSPP
p. J19



WARNING These products can expose you to chemicals including CARBON BLACK, or LEAD, which are known to the state of California to cause cancer, and LEAD which is known to cause birth defects or other reproductive harm. For more information go to www.P65Warnings.ca.gov.

Female to Female

207ACBH
Anchor Coupling
Pipe to Pipe
p. J8



207ACBH-S
Sealed Bulkhead
p. J8



207P
Coupling
Pipe to Pipe
p. J8



208P
Reducer Coupling
Pipe to Pipe
p. J8



212P
Union
Pipe to Pipe
p. J9



1200P-2200P
Union Elbow
Pipe to Pipe
p. J10



1203P-2203P
Union Tee
Pipe to Pipe
p. J11



2200PDE
Drop-Ear Elbow
Pipe to Pipe
p. J12



1201-2201P
45° Female Elbow
Pipe to Pipe
p. J12



2205P
Cross
Pipe to Pipe
p. J12



0143
Union Elbow
BSPP to BSPP
p. J14



0145
Union Tee
BSPP to BSPP
p. J14



0117
Bulkhead
BSPP to BSPP
p. J15



0155
Coupling
BSPP to BSPP
p. J16



0168
Adapter
BSPP to BSPP
p. J16



0912
Union Elbow
BSPP to BSPP
p. J17



0910
Union Y
BSPP to BSPP
p. J17



0915
Union Tee
BSPP to BSPP
p. J17



0908
Cross
BSPP to BSPP
p. J18



0920
Bulkhead
BSPP to BSPP
p. J19



0902
Coupling
BSPP to BSPP
p. J20



Threaded Fittings (ISO Port Adapters)

222P-X-MIX
Adapter
p. J14, J24



48F-X-MIX
Male Connector
p. J24



149F-X-MIX
Male Elbow
p. J24



159F-X-MIX
45° Male Elbow
p. J24



68HB-X-MIX
Male Connector
p. J24



169HB-X-MIX
Male Elbow
p. J24



68NTA-X-MIX
Male Connector
p. J24



179HB-X-MIX
45° Male Elbow
p. J24



Garden Hose Fittings

50GHSV
Swivel Connector
p. J26



54GH-55GH
Hose Barb
p. J26



69GH-70GH-71GH
Male Pipe
p. J26



75GH
Connector
p. J26



78GH-79GH-80GH-81GH
Female Pipe
p. J26



82GH-83GH
Female Hose
p. J26



88GH
Swivel Connector
p. J26



90GH
Swivel Connector
p. J26



98GH-99GH
Hose to Pipe
p. J27



98GHSV-99GHSV
Swivel Connector
p. J27



101GHSV
Swivel Nut
Connector
p. J27



WARNING These products can expose you to chemicals including CARBON BLACK, or LEAD, which are known to the state of California to cause cancer, and LEAD which is known to cause birth defects or other reproductive harm. For more information go to www.P65Warnings.ca.gov.

- A
- B
- C
- D
- E
- F
- G
- H
- I
- J
- K
- L
- M
- N
- O

Accessories

207ACBH-WSHR

Sealing Washer Kit
p. J8



210P

Lock Nut
p. J9



211P

Square Head Plug
p. J9



213P

Cap
p. J9



218P

Hex Head Plug
p. J10



219P

Countersunk Plug
p. J10



220P

Slotted Head Plug
p. J10



0200

Hex Head Plug
BSPP, Metric
p. J20



0205

Internal Hex Head Plug – NPT, BSPT
p. J20



0285

Internal Hex Head Plug – NPT, BSPT
p. J21



0206

Internal Hex Head NPT, BSPT
p. J21



0138

Copper Washer
BSPP, Metric
p. J21



0139

Bi-Material Captive Sealing Washer
BSPP
p. J21



0602

Captive Sealing Washer – BSPP, M5
p. J21



94GH

Hose Nut
p. J26



95GH

Hose Nut Reducer
p. J27



96GH

Hose Cap
p. J27



901GH

Washer
p. J27



1163-60-BPD

Coupler
p. J27



1163-61-BPD

Nipple
p. J27



⚠ WARNING These products can expose you to chemicals including CARBON BLACK, or LEAD, which are known to the state of California to cause cancer, and LEAD which is known to cause birth defects or other reproductive harm. For more information go to www.P65Warnings.ca.gov.





Pipe Fittings

Parker's Pipe Fittings meet all functional requirements of SAE J530 and SAE J531. All threads on the pipe fittings are made to dryseal standards.

Product Features:

- All brass construction
- Meets functional requirements of SAE J530 and SAE J531
- Threads made to dryseal standards
- Both forgings and extrusions available

Markets:

- Industrial
- Construction
- Heavy duty truck
- Mobile
- Factory/process automation

Applications:

- Air Lines
- Water Line
- Cooling Lines

Specifications:

Pressure Range Up to 1000 PSI (68.9 bar)

Temperature Range -65° to +250° F (-53.9° to +121.1° C)

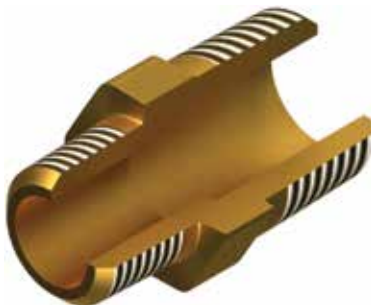

Assembly Instructions

Straight Fittings

1. Hand tighten external thread into internal thread
2. Tighten an additional 2 turns with a wrench up to 1/2" male pipe thread.
3. Above 1/2" 1 1/2 to 2 1/2 turns.

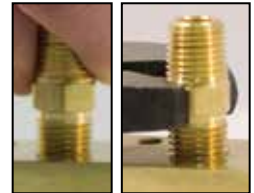

Elbow or Tee Fittings

1. Hand tighten external thread into internal thread
2. Tighten an additional 1 to 1 1/2 turns with a wrench
3. Tighten fitting, clockwise to align with tubing. (Never counter clockwise)

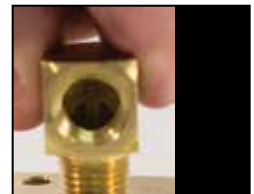

Note: To minimize the possibility of a leaking threaded joint after assembling Male to female pipe threads, neither end should be backed out (loosened) Once the assembly has been made.

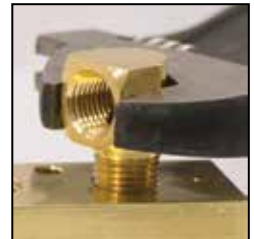

WARNING These products can expose you to chemicals including LEAD which is known to the state of California to cause cancer and birth defects or other reproductive harm. For more information go to www.P65Warnings.ca.gov.



[Click here for CADs, Product Specifications or to Configure Parts Online](#)

- A
- B
- C
- D
- E
- F
- G
- H
- I
- J
- K
- L
- M
- N
- O

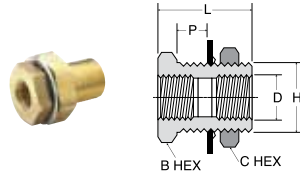

Bulkhead 207ACBH

| PART NO. | FEAMLE PIPE THREAD | STRAIGHT THREAD | MAX. BULK HEAD P | B HEX | C HEX | L | BLKHD HOLE DIA. H | FLOW DIA. D |
|-------------|--------------------|-----------------|------------------|-------|-------|------|-------------------|-------------|
| 207ACBH-2 | 1/8 | 5/8-18 | .89 | 7/8 | 15/16 | 1.50 | 5/8 | .339 |
| 207ACBHS-2 | 1/8 | 5/8-18 | .35 | 7/8 | 15/16 | .96 | 5/8 | .339 |
| 207ACBH-4 | 1/4 | 3/4-16 | .81 | 1 | 1-1/8 | 1.50 | 3/4 | .441 |
| 207ACBHS-4 | 1/4 | 3/4-16 | .26 | 1 | 1 | .94 | 3/4 | .441 |
| 207ACBH-6 | 3/8 | 1-14 | .62 | 1-1/8 | 1-1/4 | 1.31 | 1 | .571 |
| 207ACBH-8 | 1/2 | 1-1/8-14 | .75 | 1-1/4 | 1-3/8 | 1.50 | 1-1/8 | .703 |
| 207ACBH-12 | 3/4 | 1-5/16-12 | .65 | 1-1/2 | 1-1/2 | 1.50 | 1-5/16 | .906 |
| 207ACBH-16* | 1 | 1-5/8-14 | 1.00 | 2 | 2 | 1.68 | 1-5/8 | 1.140 |

*Lock Washer not Available

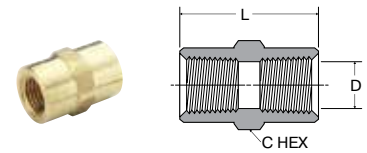

Coupling 207P

| PART NO. | PIPE THREAD | C HEX | L | FLOW DIA. D |
|----------|-------------|--------|------|-------------|
| 207P-2 | 1/8 | 9/16 | .75 | .339 |
| 207P-4 | 1/4 | 3/4 | 1.12 | .441 |
| 207P-6 | 3/8 | 7/8 | 1.12 | .571 |
| 207P-8 | 1/2 | 1-1/16 | 1.50 | .703 |
| 207P-12 | 3/4 | 1-3/8 | 1.53 | .906 |

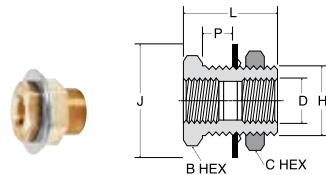

Sealed Bulkhead 207ACBH-S

| PART NO. | FEAMLE PIPE THREAD | STRAIGHT THREAD | MAX. BULK HEAD P | B HEX | C HEX | J | L | BLKHD HOLE DIA. H | FLOW DIA. D |
|--------------|--------------------|-----------------|------------------|-------|-------|------|------|-------------------|-------------|
| 207ACBH-2-S | 1/8 | 5/8-18 | .84 | 7/8 | 15/16 | 1.19 | 1.50 | .656 | .339 |
| 207ACBHS-2-S | 1/8 | 5/8-18 | .30 | 7/8 | 15/16 | 1.19 | .96 | .656 | .339 |
| 207ACBH-4-S | 1/4 | 3/4-16 | .75 | 1 | 1-1/8 | 1.31 | 1.50 | .781 | .441 |
| 207ACBHS-4-S | 1/4 | 3/4-16 | .20 | 1 | 1 | 1.31 | .94 | .781 | .441 |
| 207ACBH-6-S | 3/8 | 1-14 | .56 | 1-1/8 | 1-1/4 | 1.75 | 1.31 | 1.031 | .571 |

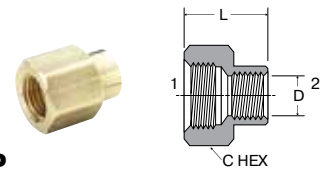

Reducer Coupling 208P

| PART NO. | 1 PIPE THREAD | 2 PIPE THREAD | C HEX | L | FLOW DIA. D |
|-----------|---------------|---------------|--------|------|-------------|
| 208P-4-2 | 1/4 | 1/8 | 3/4 | .97 | .339 |
| 208P-6-4 | 3/8 | 1/4 | 7/8 | 1.16 | .441 |
| 208P-8-4 | 1/2 | 1/4 | 1-1/16 | 1.28 | .441 |
| 208P-8-6 | 1/2 | 3/8 | 1-1/16 | 1.38 | .571 |
| 208P-12-6 | 3/4 | 3/8 | 1-3/8 | 1.32 | .571 |
| 208P-12-8 | 3/4 | 1/2 | 1-3/8 | 1.50 | .703 |

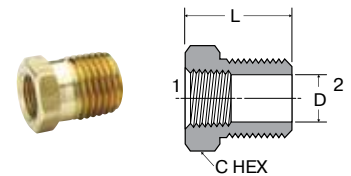

Bushing 209P

| PART NO. | 1 PIPE THREAD | 2 PIPE THREAD | C HEX | L | FLOW DIA. D |
|------------|---------------|---------------|-------|------|-------------|
| 209P-4-2 | 1/8 | 1/4 | 9/16 | .75 | .339 |
| 209P-6-2 | 1/8 | 3/8 | 11/16 | .75 | .339 |
| 209P-6-4 | 1/4 | 3/8 | 3/4 | .75 | .441 |
| 209P-8-2 | 1/8 | 1/2 | 7/8 | 1.00 | .339 |
| 209P-8-4 | 1/4 | 1/2 | 7/8 | 1.00 | .441 |
| 209P-8-6 | 3/8 | 1/2 | 7/8 | 1.00 | .571 |
| 209P-12-2 | 1/8 | 3/4 | 1-1/8 | 1.00 | .339 |
| 209P-12-4 | 1/4 | 3/4 | 1-1/8 | 1.00 | .441 |
| 209P-12-6 | 3/8 | 3/4 | 1-1/8 | 1.00 | .571 |
| 209P-12-8 | 1/2 | 3/4 | 1-1/8 | 1.00 | .703 |
| 209P-16-8 | 1/2 | 1 | 1-3/8 | 1.31 | .703 |
| 209P-16-12 | 3/4 | 1 | 1-3/8 | 1.31 | .906 |

Sealing Washer Kit (10 pcs)

| PART NO. | INNER DIA. | OUTER DIA. |
|----------------|------------|------------|
| 207ACBH-WSHR-2 | .625 | 1.19 |
| 207ACBH-WSHR-4 | .75 | 1.31 |
| 207ACBH-WSHR-6 | 1.00 | 1.75 |

WARNING These products can expose you to chemicals including LEAD which is known to the state of California to cause cancer and birth defects or other reproductive harm. For more information go to www.P65Warnings.ca.gov.

Click here for CADs, Product Specifications or to Configure Parts Online

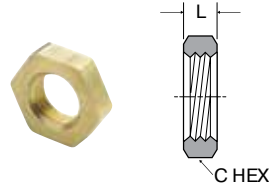

Lock Nut 210P

| PART NO. | PIPE THREAD | C HEX | L |
|----------|-------------|-------|-----|
| 210P-2 | 1/8 NPSL | 11/16 | .19 |
| 210P-4 | 1/4 NPSL | 7/8 | .25 |
| 210P-6 | 3/8 NPSL | 1 | .25 |
| 210P-8 | 1/2 NPSL | 1-1/8 | .25 |

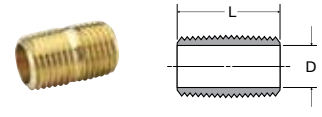

Close Nipple 215PN

| PART NO. | PIPE THREAD | L | FLOW DIA. D |
|----------|-------------|------|-------------|
| 215PN-2 | 1/8 | .75 | .281 |
| 215PN-4 | 1/4 | .88 | .375 |
| 215PN-6 | 3/8 | 1.00 | .500 |
| 215PN-8 | 1/2 | 1.13 | .625 |
| 215PN-12 | 3/4 | 1.31 | .750 |

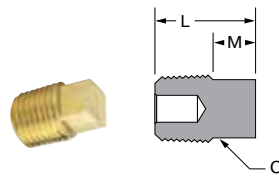

Square-Head Plug 211P

| PART NO. | PIPE THREAD | C | L | M |
|----------|-------------|------|------|-----|
| 211P-2 | 1/8 | 9/32 | .59 | .25 |
| 211P-4 | 1/4 | 3/8 | .80 | .29 |
| 211P-6 | 3/8 | 7/16 | .83 | .32 |
| 211P-8 | 1/2 | 9/16 | 1.07 | .39 |
| 211P-12 | 3/4 | 5/8 | 1.14 | .45 |

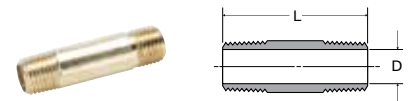

Long Nipple 215PNL

| PART NO. | PIPE THREAD | L | FLOW DIA. D |
|-------------|-------------|-------|-------------|
| 215PNL-2-15 | 1/8 | 1-1/2 | .250 |
| 215PNL-4-15 | 1/4 | 1-1/2 | .375 |
| 215PNL-6-15 | 3/8 | 1-1/2 | .500 |
| 215PNL-8-15 | 1/2 | 1-1/2 | .625 |
| 215PNL-2-20 | 1/8 | 2 | .250 |
| 215PNL-4-20 | 1/4 | 2 | .375 |
| 215PNL-6-20 | 3/8 | 2 | .500 |
| 215PNL-8-20 | 1/2 | 2 | .625 |
| 215PNL-2-25 | 1/8 | 2-1/2 | .250 |
| 215PNL-4-25 | 1/4 | 2-1/2 | .375 |
| 215PNL-6-25 | 3/8 | 2-1/2 | .500 |
| 215PNL-8-25 | 1/2 | 2-1/2 | .625 |
| 215PNL-2-30 | 1/8 | 3 | .250 |
| 215PNL-4-30 | 1/4 | 3 | .375 |
| 215PNL-6-30 | 3/8 | 3 | .500 |
| 215PNL-8-30 | 1/2 | 3 | .625 |
| 215PNL-2-35 | 1/8 | 3-1/2 | .250 |
| 215PNL-4-35 | 1/4 | 3-1/2 | .375 |
| 215PNL-6-35 | 3/8 | 3-1/2 | .500 |
| 215PNL-8-35 | 1/2 | 3-1/2 | .625 |

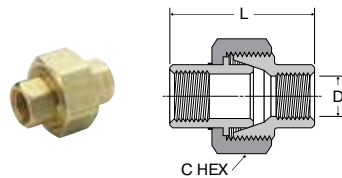

Union 212P

| PART NO. | PIPE THREAD | C HEX | L | D |
|----------|-------------|--------|------|------|
| 212P-4 | 1/4 | 1-3/16 | 1.54 | .441 |
| 212P-6 | 3/8 | 1-1/4 | 1.76 | .571 |

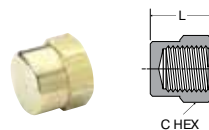

Cap 213P

| PART NO. | PIPE THREAD | C HEX | L |
|----------|-------------|--------|-----|
| 213P-2 | 1/8 | 9/16 | .50 |
| 213P-4 | 1/4 | 11/16 | .63 |
| 213P-6 | 3/8 | 13/16 | .63 |
| 213P-8 | 1/2 | 1-1/16 | .87 |
| 213P-12 | 3/4 | 1-1/4 | .89 |

WARNING These products can expose you to chemicals including LEAD which is known to the state of California to cause cancer and birth defects or other reproductive harm. For more information go to www.P65Warnings.ca.gov.



Click here for CADs, Product Specifications or to Configure Parts Online

- A
- B
- C
- D
- E
- F
- G
- H
- I
- J
- K
- L
- M
- N
- O

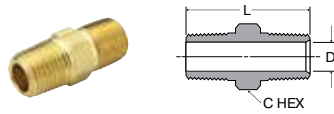

Hex Nipple 216P

| PART NO. | PIPE THREAD | C HEX | L | FLOW DIA. D |
|----------|-------------|--------|------|-------------|
| 216P-2 | 1/8 | 7/16 | .97 | .220 |
| 216P-4 | 1/4 | 9/16 | 1.38 | .314 |
| 216P-6 | 3/8 | 11/16 | 1.41 | .440 |
| 216P-8 | 1/2 | 7/8 | 1.81 | .564 |
| 216P-12 | 3/4 | 1-1/16 | 1.81 | .752 |

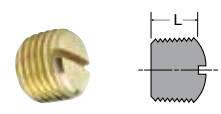

Slotted-Head Plug 220P

| PART NO. | PIPE THREAD | L |
|----------|-------------|-----|
| 220P-2 | 1/8 | .31 |
| 220P-4 | 1/4 | .42 |
| 220P-6 | 3/8 | .43 |

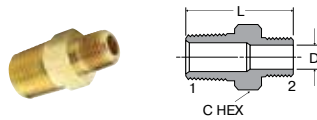

Hex Nipple Reducers 216P

| PART NO. | 1 PIPE THREAD | 2 PIPE THREAD | C HEX | L | FLOW DIA. D |
|-----------|---------------|---------------|--------|------|-------------|
| 216P-4-2 | 1/4 | 1/8 | 9/16 | 1.19 | .220 |
| 216P-6-2 | 3/8 | 1/8 | 11/16 | 1.22 | .220 |
| 216P-6-4 | 3/8 | 1/4 | 11/16 | 1.41 | .314 |
| 216P-8-4 | 1/2 | 1/4 | 7/8 | 1.62 | .314 |
| 216P-8-6 | 1/2 | 3/8 | 7/8 | 1.62 | .440 |
| 216P-12-8 | 3/4 | 1/2 | 1-1/16 | 1.80 | .564 |

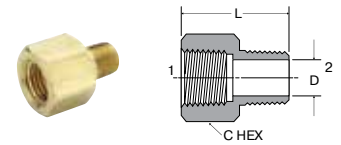

Adapter 222P

| PART NO. | 1 PIPE THREAD | 2 PIPE THREAD | C HEX | L | FLOW DIA. D |
|------------|---------------|---------------|--------|------|-------------|
| 222P-2-2 | 1/8 | 1/8 | 9/16 | .88 | .220 |
| 222P-4-2 | 1/4 | 1/8 | 3/4 | 1.06 | .220 |
| 222P-4-4 | 1/4 | 1/4 | 3/4 | 1.25 | .314 |
| 222P-6-2 | 3/8 | 1/8 | 7/8 | 1.10 | .220 |
| 222P-6-4 | 3/8 | 1/4 | 7/8 | 1.25 | .314 |
| 222P-6-6 | 3/8 | 3/8 | 7/8 | 1.25 | .440 |
| 222P-8-4 | 1/2 | 1/4 | 1 | 1.47 | .314 |
| 222P-8-6 | 1/2 | 3/8 | 1-1/16 | 1.47 | .440 |
| 222P-8-8 | 1/2 | 1/2 | 1-1/16 | 1.66 | .564 |
| 222P-12-6 | 3/4 | 3/8 | 1-3/8 | 1.50 | .440 |
| 222P-12-8 | 3/4 | 1/2 | 1-3/8 | 1.69 | .564 |
| 222P-12-12 | 3/4 | 3/4 | 1-3/8 | 1.69 | .752 |

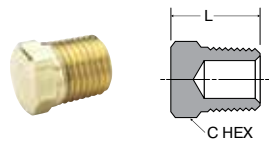

Hex-Head Plug 218P

| PART NO. | PIPE THREAD | C HEX | L |
|----------|-------------|--------|-------|
| 218P-2 | 1/8 | 7/16 | .560 |
| 218P-4 | 1/4 | 9/16 | .747 |
| 218P-6 | 3/8 | 11/16 | .780 |
| 218P-8 | 1/2 | 7/8 | .970 |
| 218P-12 | 3/4 | 1-1/16 | 1.054 |

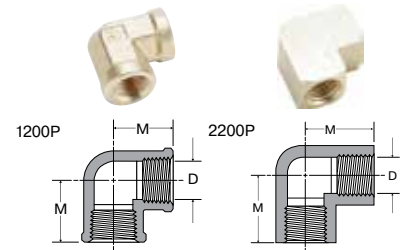

90° Union Elbow 1200P-2200P

| PART NO. | PIPE THREAD | M | FLOW DIA. D |
|-----------|-------------|------|-------------|
| 1200P-2-2 | 1/8 | .56 | .329 |
| 2200P-2-2 | 1/8 | .55 | .339 |
| 1200P-4-4 | 1/4 | .81 | .441 |
| 2200P-4-4 | 1/4 | .78 | .441 |
| 1200P-6-6 | 3/8 | .84 | .571 |
| 2200P-6-6 | 3/8 | .84 | .571 |
| 2200P-8-8 | 1/2 | 1.07 | .703 |

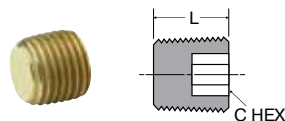

Countersunk Hex-Head Plug 219P

| PART NO. | PIPE THREAD | C HEX | L |
|----------|-------------|-------|-----|
| 219P-2 | 1/8 | 3/16 | .30 |
| 219P-4 | 1/4 | 1/4 | .46 |
| 219P-6 | 3/8 | 5/16 | .46 |
| 219P-8 | 1/2 | 3/8 | .61 |
| 219P-12 | 3/4 | 9/16 | .62 |

WARNING These products can expose you to chemicals including LEAD which is known to the state of California to cause cancer and birth defects or other reproductive harm. For more information go to www.P65Warnings.ca.gov.

[Click here for CADs, Product Specifications or to Configure Parts Online](#)

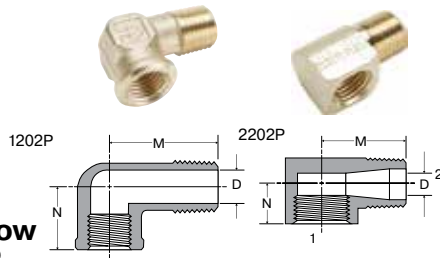

**90° Street Elbow
1202P-2202P**

| PART NO. | 1 PIPE THREAD | 2 PIPE THREAD | M | N | FLOW DIA. D |
|-------------|---------------|---------------|------|------|-------------|
| 1202P-2-2 | 1/8 | 1/8 | .81 | .56 | .22 |
| 2202P-2-2 | 1/8 | 1/8 | .62 | .48 | .22 |
| 2202PA-2-2* | 1/8 | 1/8 | .66 | .48 | .22 |
| 2202P-4-2 | 1/4 | 1/8 | .72 | .45 | .23 |
| 1202P-4-4 | 1/4 | 1/4 | 1.08 | .69 | .31 |
| 2202P-4-4 | 1/4 | 1/4 | .91 | .45 | .34 |
| 2202PA-4-4* | 1/4 | 1/4 | .91 | .72 | .31 |
| 2202P-4-6 | 1/4 | 3/8 | .97 | .78 | .43 |
| 1202P-6-4 | 3/8 | 1/4 | 1.25 | .78 | .31 |
| 1202P-6-6 | 3/8 | 3/8 | 1.25 | .78 | .42 |
| 2202P-6-6 | 3/8 | 3/8 | .98 | .54 | .41 |
| 2202PA-6-6* | 3/8 | 3/8 | .97 | .78 | .43 |
| 1202P-6-8 | 3/8 | 1/2 | 1.53 | 1.01 | .56 |
| 1202P-8-6 | 1/2 | 3/8 | 1.25 | .97 | .42 |
| 2202P-8-8 | 1/2 | 1/2 | 1.25 | 1.03 | .56 |
| 2202P-12-8 | 3/4 | 1/2 | 1.39 | 1.10 | .56 |
| 2202P-12-12 | 3/4 | 3/4 | 1.39 | 1.10 | .75 |

*Meets SAE Dimensions

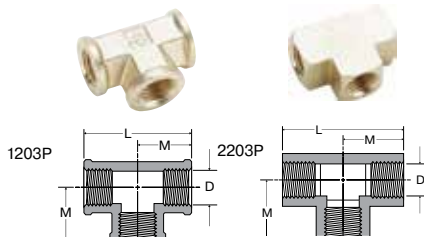

**Union Tee
1203P-2203P**

| PART NO. | PIPE THREAD | L | M | FLOW DIA. D |
|----------|-------------|------|------|-------------|
| 1203P-2 | 1/8 | 1.12 | .56 | .339 |
| 2203P-2 | 1/8 | 1.06 | .53 | .339 |
| 1203P-4 | 1/4 | 1.38 | .69 | .441 |
| 2203P-4 | 1/4 | 1.52 | .76 | .441 |
| 2203P-6 | 3/8 | 1.68 | .84 | .571 |
| 1203P-8 | 1/2 | 2.14 | 1.07 | .703 |
| 2203P-8 | 1/2 | 2.14 | 1.07 | .703 |
| 2203P-12 | 3/4 | 2.28 | 1.14 | .906 |

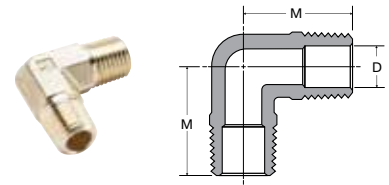

Male Elbow 1204P

| PART NO. | PIPE THREAD | M | FLOW DIA. D |
|----------|-------------|------|-------------|
| 1204P-2 | 1/8 | .71 | .220 |
| 1204P-4 | 1/4 | 1.09 | .312 |
| 1204P-6 | 3/8 | 1.09 | .408 |
| 1204P-8 | 1/2 | 1.41 | .502 |

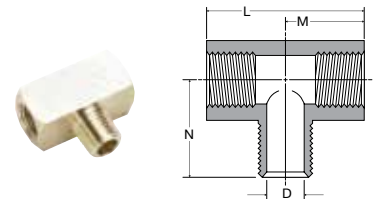

Male Branch Tee 2224P

| PART NO. | PIPE THREAD | L | M | N | FLOW DIA. D |
|----------|-------------|------|------|------|-------------|
| 2224P-2 | 1/8 | 1.06 | .53 | .66 | .220 |
| 2224P-4 | 1/4 | 1.52 | .76 | .91 | .314 |
| 2224P-6 | 3/8 | 1.68 | .84 | .97 | .440 |
| 2224P-8 | 1/2 | 2.18 | 1.09 | 1.25 | .564 |
| 2224P-12 | 3/4 | 2.32 | 1.16 | 1.38 | .752 |

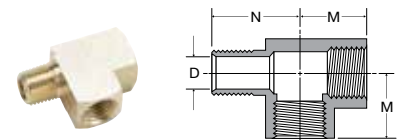

Street Tee 2225P

| PART NO. | PIPE THREAD | M | N | DIA. D |
|----------|-------------|------|------|--------|
| 2225P-2 | 1/8 | .53 | .66 | .220 |
| 2225P-4 | 1/4 | .76 | .91 | .314 |
| 2225P-6 | 3/8 | .84 | .98 | .440 |
| 2225P-8 | 1/2 | 1.07 | 1.26 | .564 |
| 2225P-12 | 3/4 | 1.14 | 1.38 | .752 |

WARNING These products can expose you to chemicals including LEAD which is known to the state of California to cause cancer and birth defects or other reproductive harm. For more information go to www.P65Warnings.ca.gov.



[Click here for CADs, Product Specifications or to Configure Parts Online](#)

- A
- B
- C
- D
- E
- F
- G
- H
- I
- J
- K
- L
- M
- N
- O

Drop-ear 90° Elbow 2200PDE

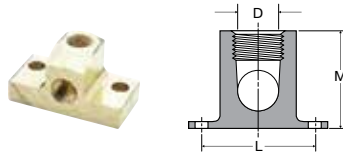

| PART NO. | PIPE THREAD | L | M | FLOW DIA. D |
|-----------|-------------|------|------|-------------|
| 2200PDE-2 | 1/8 | 1.38 | 1.00 | .339 |

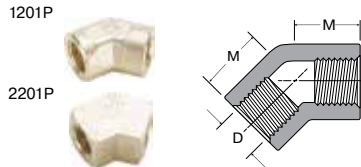

45° Female Elbow 1201P-2201P

| PART NO. | PIPE THREAD | M | FLOW DIA. D |
|-----------|-------------|-----|-------------|
| 2201P-2-2 | 1/8 | .43 | .339 |
| 1201P-8-8 | 1/2 | .89 | .703 |

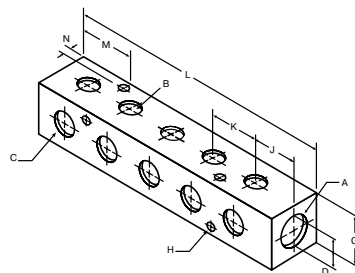

Brass Manifold 255M

| PART NO. | PIPE THREAD A | PIPE THREAD B | PIPE THREAD C | G | MOUNTING HOLE DIA. H | J | K | L | M | N | D |
|--------------|---------------|---------------|---------------|------|----------------------|-----|------|------|------|-----|-----|
| X255MP-6-4-2 | 3/8 | 1/8 | 1/4 | 1.25 | .22 | .88 | 1.13 | 6.25 | 1.45 | .25 | .25 |

Cross 2205P

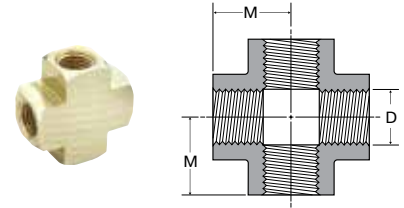

| PART NO. | PIPE THREAD | M | FLOW DIA. D |
|----------|-------------|------|-------------|
| 2205P-2 | 1/8 | .53 | .339 |
| 2205P-4 | 1/4 | .75 | .441 |
| 2205P-6 | 3/8 | .81 | .571 |
| 2205P-8 | 1/2 | 1.07 | .703 |
| 2205P-12 | 3/4 | 1.14 | .906 |

45° Street Elbow 2214P

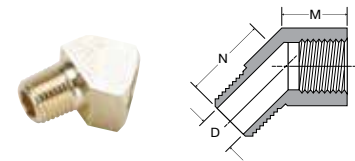

| PART NO. | PIPE THREAD | M | N | FLOW DIA. D |
|-------------|-------------|-----|------|-------------|
| 2214P-2-2 | 1/8 | .38 | .50 | .220 |
| 2214P-4-4 | 1/4 | .54 | .70 | .314 |
| 2214P-6-6 | 3/8 | .56 | .78 | .440 |
| 2214P-8-8 | 1/2 | .73 | 1.00 | .564 |
| 2214P-12-12 | 3/4 | .75 | 1.35 | .750 |

WARNING These products can expose you to chemicals including LEAD which is known to the state of California to cause cancer and birth defects or other reproductive harm. For more information go to www.P65Warnings.ca.gov.

A
B
C
D
E
F
G
H
I
J
K
L
M
N
O



Metric Adapters

Parker's Metric Adapters offers a comprehensive range of NPT, BSPT, BSPP and metric pipe threads. Metric adapters are produced in both forgings and extrusions.

Product Features:

- All brass construction
- Nickel plated adapters
- Robust design
- Reusable

Markets:

- Industrial
- Construction
- Heavy duty truck
- Mobile
- Factory/process automation

Applications:

- Air Lines
- Water Line
- Cooling Lines

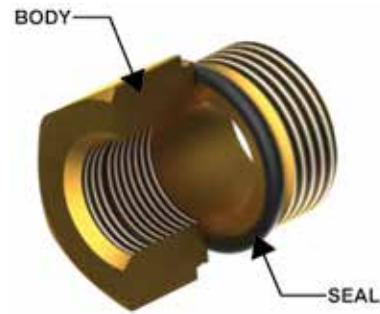

Specifications:

| | Pressure Range | Temperature Range |
|----------------------------|---|--|
| Brass | 1/8" to 1/2": 2900 PSI (200 bar) | -76F to +302F (-60°C to +150°C) |
| | 3/4" and 1": 2175 PSI (150 bar) without sealing washer | without sealing washer -4F to +34F (-20°C to +100°C) with sealing washer |
| Nickel-plated Brass | 870 PSI (59.9 bar) | +14F to +176F (-10°C to +80°C) |

WARNING These products can expose you to chemicals including LEAD which is known to the state of California to cause cancer and birth defects or other reproductive harm. For more information go to www.P65Warnings.ca.gov.



A
B
C
D
E
F
G
H
I
J
K
L
M
N
O

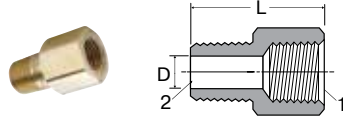

F3HG Adapter NPTF Male BSPT

| PART NO. | NPTF 1 | BSPT 2 | C HEX | L | FLOW D |
|-----------|--------|--------|--------|------|--------|
| 1/8F3HG-B | 1/8 | 1/8 | 9/16 | .93 | .22 |
| 1/4F3HG-B | 1/4 | 1/4 | 3/4 | 1.35 | .31 |
| 3/8F3HG-B | 3/8 | 3/8 | 7/8 | 1.35 | .44 |
| 1/2F3HG-B | 1/2 | 1/2 | 1-1/16 | 1.76 | .56 |

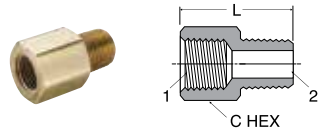

0164 Adapter Male NPT/Female BSPP

| PART NO. | BSPP 1 | NPTF 2 | C HEX | L |
|------------|--------|--------|-------|------|
| 0164 11 10 | 1/8 | 1/8 | 14 | 20 |
| 0164 14 13 | 1/4 | 1/4 | 17 | 27.5 |
| 0164 18 17 | 3/8 | 3/8 | 22 | 28.5 |
| 0164 22 21 | 1/2 | 1/2 | 27 | 36.5 |
| 0164 28 27 | 3/4 | 3/4 | 32 | 38.5 |

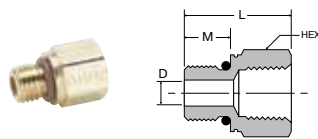

Pipe to Metric Adaptor 222P-X-MIX

| PART NO. | NPTF | METRIC THREAD | HEX | L | M | D |
|-------------|--------|---------------|--------|------|-----|-----|
| 222P-2-MI10 | 1/8-27 | M10 X 1.0 | 9/16 | .75 | .34 | .18 |
| 222P-2-MI14 | 1/8-27 | M14 X 1.5 | 3/4 | .91 | .43 | .30 |
| 222P-4-MI12 | 1/4-18 | M12 X 1.5 | 11/16 | 1.09 | .43 | .24 |
| 222P-6-MI16 | 3/8-18 | M16 X 1.5 | 7/8 | 1.10 | .45 | .35 |
| 222P-6-MI22 | 3/8-18 | M22 X 1.5 | 1 1/16 | 1.05 | .37 | .47 |
| 222P-8-MI27 | 1/2-14 | M27 X 2.0 | 1 1/4 | 1.32 | .63 | .60 |

Note: Fluorocarbon o-ring is standard

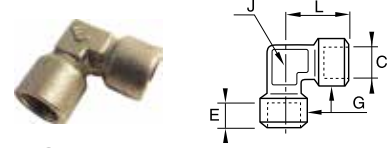

0143 90° Union Elbow BSPP

| PART NO. | C BSPP | E MM | G MM | J MM | L MM | WT. KG |
|------------|--------|------|------|------|------|--------|
| 0143 10 10 | G1/8 | 7.5 | 16.5 | 12 | 22.5 | .042 |
| 0143 13 13 | G1/4 | 11 | 18.5 | 15 | 26.5 | .055 |
| 0143 17 17 | G3/8 | 11.5 | 23.5 | 19 | 31.5 | .098 |
| 0143 21 21 | G1/2 | 15 | 28 | 23 | 35.5 | .158 |
| 0143 27 27 | G3/4 | 16.5 | 34 | 27 | 43.5 | .256 |

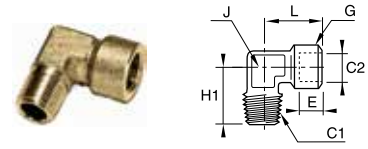

0144 Street Elbow Female BSPP to Male BSPT

| PART NO. | C1 BSPT | C2 BSPP | E MM | G MM | H1 MM | J MM | L MM | WT. KG |
|------------|---------|---------|------|------|-------|------|------|--------|
| 0144 10 10 | R1/8 | G1/8 | 7.5 | 16.5 | 23 | 12 | 22.5 | .033 |
| 0144 13 13 | R1/4 | G1/4 | 11 | 18.5 | 26 | 15 | 26.5 | .050 |
| 0144 17 17 | R3/8 | G3/8 | 11.5 | 23.5 | 30 | 19 | 31.5 | .085 |
| 0144 21 21 | R1/2 | G1/2 | 15 | 28 | 35 | 23 | 34.5 | .138 |
| 0144 27 27 | R3/4 | G3/4 | 16.5 | 34 | 40 | 27 | 43.5 | .229 |

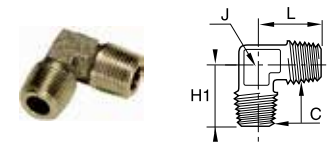

0152 Union Elbow Male BSPT

| PART NO. | C BSPT | H1 MM | J MM | L MM | WT. KG |
|------------|--------|-------|------|------|--------|
| 0152 10 10 | R1/8 | 19.5 | 10 | 19.5 | .018 |
| 0152 13 13 | R1/4 | 25 | 15 | 25 | .045 |
| 0152 17 17 | R3/8 | 26.5 | 15 | 26.5 | .056 |
| 0152 21 21 | R1/2 | 31.5 | 19 | 31.5 | .087 |
| 0152 27 27 | R3/4 | 35.5 | 23 | 35.5 | .153 |

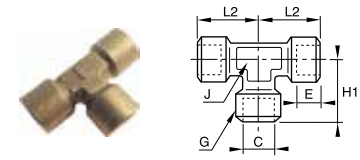

0145 Female Union Tee BSPP

| PART NO. | C BSPP | E MM | G MM | H1 MM | J MM | L2 MM | WT. KG |
|------------|--------|------|------|-------|------|-------|--------|
| 0145 10 10 | G1/8 | 7.5 | 16.5 | 22.5 | 12 | 22.5 | .051 |
| 0145 13 13 | G1/4 | 11 | 18.5 | 26.5 | 15 | 26.5 | .074 |
| 0145 17 17 | G3/8 | 11.5 | 23.5 | 31 | 19 | 31 | .147 |
| 0145 21 21 | G1/2 | 15 | 28 | 38 | 23 | 38 | .231 |
| 0145 27 27 | G3/4 | 16.5 | 34 | 47.5 | 27 | 47.5 | .381 |

WARNING These products can expose you to chemicals including LEAD which is known to the state of California to cause cancer and birth defects or other reproductive harm. For more information go to www.P65Warnings.ca.gov.



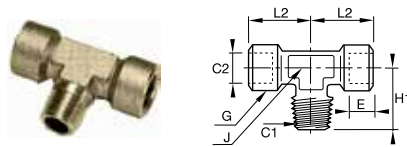

0158 Branch Tee Female BSPP to Male BSPT

| PART NO. | C1 BSPT | C2 BSPP | E MM | G MM | H1 MM | J MM | L2 MM | WT. KG |
|------------|---------|---------|------|------|-------|------|-------|--------|
| 0158 10 10 | R1/8 | G1/8 | 7.5 | 16.5 | 21.5 | 12 | 21.5 | .045 |
| 0158 13 13 | R1/4 | G1/4 | 11 | 18.5 | 26 | 15 | 26 | .071 |
| 0158 17 17 | R3/8 | G3/8 | 11.5 | 23.5 | 30 | 19 | 30 | .118 |
| 0158 21 21 | R1/2 | G1/2 | 15 | 28 | 36 | 23 | 36 | .203 |
| 0158 27 27 | R3/4 | G3/4 | 16.5 | 34 | 44 | 27 | 44 | .320 |

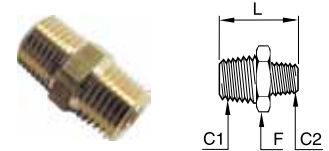

0121 Hex Nipple Male BSPT

| PART NO. | C1 BSPT | C2 BSPT | F MM | L MM | WT. KG |
|------------|---------|---------|------|------|--------|
| 0121 10 10 | R1/8 | R1/8 | 11 | 19 | .009 |
| 0121 13 13 | R1/4 | R1/4 | 14 | 27 | .021 |
| 0121 13 10 | R1/4 | R1/8 | 14 | 23.5 | .021 |
| 0121 17 17 | R3/8 | R3/8 | 17 | 28 | .025 |
| 0121 17 13 | R3/8 | R1/4 | 17 | 27.5 | .024 |
| 0121 17 10 | R3/8 | R1/8 | 17 | 24 | .022 |
| 0121 21 21 | R1/2 | R1/2 | 22 | 36 | .053 |
| 0121 21 17 | R1/2 | R3/8 | 22 | 32.5 | .045 |
| 0121 21 13 | R1/2 | R1/4 | 22 | 32 | .045 |
| 0121 21 10 | R1/2 | R1/8 | 22 | 28.5 | .041 |
| 0121 27 27 | R3/4 | R3/4 | 27 | 40 | .092 |
| 0121 27 21 | R3/4 | R1/2 | 27 | 39 | .084 |
| 0121 27 17 | R3/4 | R3/8 | 27 | 35.5 | .076 |
| 0121 27 13 | R3/4 | R1/4 | 27 | 35 | .079 |
| 0121 34 34 | R1 | R1 | 36 | 46 | .156 |
| 0121 34 27 | R1 | R3/4 | 36 | 43 | .143 |
| 0121 34 21 | R1 | R1/2 | 36 | 42 | .133 |
| 0121 34 17 | R1 | R3/8 | 36 | 38.5 | .126 |
| 0121 42 42 | R1-1/4 | R1-1/4 | 46 | 53 | .233 |
| 0121 42 34 | R1-1/4 | R1 | 46 | 50.5 | .237 |
| 0121 42 27 | R1-1/4 | R3/4 | 46 | 47.5 | .229 |
| 0121 42 21 | R1-1/4 | R1/2 | 46 | 46.5 | .219 |

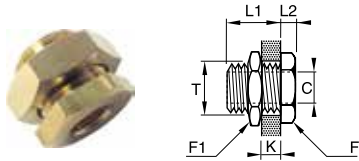

0117 Bulkhead BSPP and M5

| PART NO. | C BSPP/M5 | F MM | F1 MM | K MAX MM | L1 MM | L2 MM | T MAX MM | WT. KG |
|------------|-----------|------|-------|----------|-------|-------|----------|--------|
| 0117 00 19 | M5X0.8 | 14 | 14 | 7 | 10.5 | 3.5 | 10.5 | .013 |
| 0117 00 10 | G1/8 | 19 | 22 | 9 | 14 | 4 | 16.5 | .033 |
| 0117 00 13 | G1/4 | 24 | 27 | 15 | 21 | 4 | 20.5 | .057 |
| 0117 00 17 | G3/8 | 30 | 32 | 14 | 21 | 5 | 26.5 | .096 |
| 0117 00 21 | G1/2 | 32 | 36 | 20 | 27 | 6 | 28.5 | .117 |
| 0117 00 27 | G3/4 | 41 | 41 | 22.5 | 30 | 6 | 34.5 | .162 |
| 0117 00 34 | G1 | 46 | 50 | 24.5 | 34 | 8 | 42.5 | .270 |
| 0117 00 42 | G1-1/4 | 55 | 55 | 29.5 | 39 | 8 | 49.5 | .300 |
| 0117 00 49 | G1-1/2 | 60 | 60 | 29.5 | 39 | 8 | 54.5 | .306 |

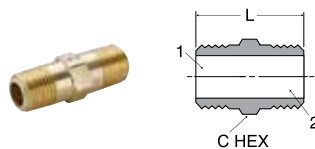

0121 Hex Nipple NPT/BSPT

| PART NO. | NPT 1 | BSPT 2 | C HEX | L |
|------------|-------|--------|-------|----|
| 0121 11 10 | 1/8 | 1/8 | 11 | 19 |
| 0121 14 13 | 1/4 | 1/4 | 14 | 27 |
| 0121 18 17 | 3/8 | 3/8 | 17 | 28 |
| 0121 22 21 | 1/2 | 1/2 | 22 | 36 |
| 0121 28 27 | 3/4 | 3/4 | 27 | 40 |

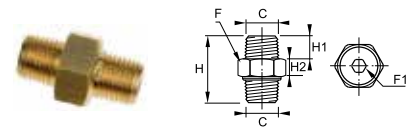

0929 3 Piece Adapter Double Male BSPT

| PART NO. | C BSPT | F MM | F1 MM | H MM | H1 MM | H2 MM | WT. KG |
|------------|--------|------|-------|------|-------|-------|--------|
| 0929 00 10 | R1/8 | 15 | 5 | 27 | 9 | 8.5 | 0.181 |
| 0929 00 13 | R1/4 | 19 | 6 | 33.5 | 11.5 | 9.5 | 0.100 |
| 0929 00 17 | R3/8 | 22 | 8 | 36.5 | 13 | 10 | 0.010 |
| 0929 00 21 | R1/2 | 27 | 12 | 45 | 15.5 | 12 | 0.088 |

Note: This connection accessory makes assembly easier thanks to its 3-piece design. To join the 2 threaded components, simply push together and tighten the nut.

WARNING These products can expose you to chemicals including LEAD which is known to the state of California to cause cancer and birth defects or other reproductive harm. For more information go to www.P65Warnings.ca.gov.



- A
- B
- C
- D
- E
- F
- G
- H
- I
- J
- K
- L
- M
- N
- O

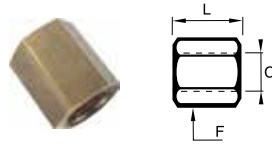

0155 Coupling BSPP

| PART NO. | C BSPP | F MM | L MM | WT. KG |
|------------|--------|------|------|--------|
| 0155 10 10 | G1/8 | 14 | 17 | .015 |
| 0155 13 13 | G1/4 | 17 | 24 | .025 |
| 0155 17 17 | G3/8 | 22 | 25 | .045 |
| 0155 21 21 | G1/2 | 27 | 32 | .084 |
| 0155 27 27 | G3/4 | 32 | 35 | .109 |

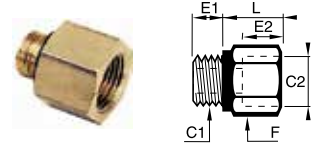

0169 Expander Female BSPP to Male BSPP

| PART NO. | C1 BSPP | C2 BSPP | E1 MM | E2 MM | F MM | L MM | WT. KG |
|------------|---------|---------|-------|-------|------|------|--------|
| 0169 10 13 | G1/8 | G1/4 | 5 | 11 | 17 | 16 | .020 |
| 0169 10 17 | G1/8 | G3/8 | 5 | 14 | 22 | 19.5 | .038 |
| 0169 13 17 | G1/4 | G3/8 | 7 | 14 | 22 | 19.5 | .042 |
| 0169 13 21 | G1/4 | G1/2 | 7 | 14.5 | 27 | 20.5 | .061 |
| 0169 17 21 | G3/8 | G1/2 | 8 | 14.5 | 27 | 20.5 | .062 |
| 0169 17 27 | G3/8 | G3/4 | 8 | 15.5 | 32 | 22 | .082 |
| 0169 21 27 | G1/2 | G3/4 | 9.5 | 15.5 | 32 | 22.5 | .088 |

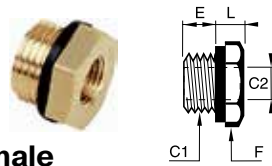

0168 Adapter Reducer Female BSPP to Male BSPP

| PART NO. | C1 BSPP | C2 BSPP | E MM | F MM | L MM | WT. KG |
|------------|---------|---------|------|------|------|--------|
| 0168 10 19 | G1/8 | M5X0.8 | 7 | 14 | 6 | .008 |
| 0168 13 19 | G1/4 | M5X0.8 | 7 | 17 | 7 | .010 |
| 0168 13 10 | G1/4 | G1/8 | 7 | 17 | 7 | .010 |
| 0168 17 10 | G3/8 | G1/8 | 9 | 19 | 6 | .020 |
| 0168 17 13 | G3/8 | G1/4 | 9 | 19 | 6 | .013 |
| 0168 21 10 | G1/2 | G1/8 | 11 | 24 | 10 | .046 |
| 0168 21 13 | G1/2 | G1/4 | 11 | 24 | 10 | .038 |
| 0168 21 17 | G1/2 | G3/8 | 11 | 24 | 10 | .026 |
| 0168 27 13 | G3/4 | G1/4 | 11 | 32 | 12 | .090 |
| 0168 27 17 | G3/4 | G3/8 | 11 | 32 | 12 | .078 |
| 0168 27 21 | G3/4 | G1/2 | 11 | 32 | 12 | .058 |

* With captive polymer seal

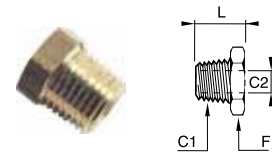

0163 Adapter Reducer Female BSPP to Male BSPT

| PART NO. | C1 BSPT | C2 BSPP | F MM | L MM | WT. KG |
|------------|---------|---------|------|------|--------|
| 0163 13 10 | R1/4 | G1/8 | 14 | 16 | .009 |
| 0163 17 10 | R3/8 | G1/8 | 17 | 16.5 | .020 |
| 0163 17 13 | R3/8 | G1/4 | 17 | 16.5 | .012 |
| 0163 21 10 | R1/2 | G1/8 | 22 | 21 | .047 |
| 0163 21 13 | R1/2 | G1/4 | 22 | 21 | .038 |
| 0163 21 17 | R1/2 | G3/8 | 22 | 21 | .025 |
| 0163 27 13 | R3/4 | G1/4 | 27 | 24 | .086 |
| 0163 27 17 | R3/4 | G3/8 | 27 | 24 | .069 |
| 0163 27 21 | R3/4 | G1/2 | 27 | 24 | .048 |

WARNING These products can expose you to chemicals including LEAD which is known to the state of California to cause cancer and birth defects or other reproductive harm. For more information go to www.P65Warnings.ca.gov.



Nickel Plated Metric Adapters

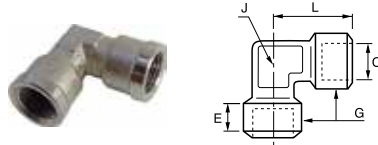

0912 Female Elbow BSPP and M5

| PART NO. | C BSPP/M5 | E MM | G MM | J MM | L MM | WT. KG |
|------------|-----------|------|------|------|------|--------|
| 0912 00 19 | M5 | 4 | 8 | 9 | 11 | .037 |
| 0912 00 10 | G1/8 | 8 | 13 | 10 | 21 | .042 |
| 0912 00 13 | G1/4 | 11 | 17 | 13 | 25.5 | .055 |
| 0912 00 17 | G3/8 | 11.5 | 21 | 17 | 28 | .098 |
| 0912 00 21 | G1/2 | 14 | 26 | 21 | 33.5 | .158 |
| 0912 00 27 | G3/4 | 15 | 31 | 27 | 36.5 | .256 |

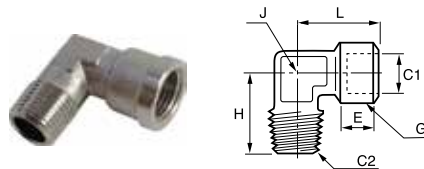

0913 / 0921 Street Elbow Female BSPP to Male BSPT and M5

| PART NO. | C1 BSPP/M5 | C2 BSPT | E MM | G MM | H MM | J MM | L MM | WT. KG |
|------------|------------|---------|------|------|------|------|------|--------|
| 0921 00 19 | M5 | | 4 | 8 | 11 | 9 | 11 | .037 |
| 0913 00 10 | G1/8 | R1/8 | 8 | 13 | 18.5 | 10 | 21 | .033 |
| 0913 00 13 | G1/4 | R1/4 | 11 | 17 | 23.5 | 13 | 25.5 | .050 |
| 0913 00 17 | G3/8 | R3/8 | 11.5 | 21 | 26 | 17 | 28 | .085 |
| 0913 00 21 | G1/2 | R1/2 | 14 | 26 | 31 | 21 | 33.5 | .138 |
| 0913 00 27 | G3/4 | R3/4 | 15 | 31 | 35 | 27 | 36.5 | .229 |

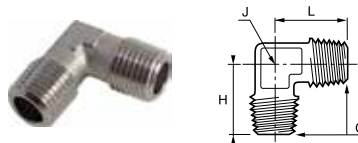

0914 / 0922 Equal Elbow Male BSPT or M5

| PART NO. | C BSPT/M5 | H MM | J MM | L MM | WT. KG |
|------------|-----------|------|------|------|--------|
| 0922 00 19 | M5 | 11 | 9 | 11 | .037 |
| 0914 00 10 | R1/8 | 18.5 | 10 | 18.5 | .018 |
| 0914 00 13 | R1/4 | 23.5 | 13 | 23.5 | .045 |
| 0914 00 17 | R3/8 | 26 | 17 | 26 | .056 |
| 0914 00 21 | R1/2 | 31 | 21 | 31 | .087 |
| 0914 00 27 | R3/4 | 35 | 27 | 35 | .153 |

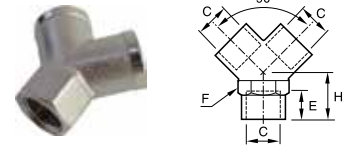

0910 "Y" Connector Female BSPP

| PART NO. | C BSPP | E MM | F MM | H MM | WT. KG |
|------------|--------|------|------|------|--------|
| 0910 00 10 | 1/8 | 8 | 13 | 12 | .055 |
| 0910 00 13 | 1/4 | 11 | 17 | 14 | .081 |
| 0910 00 17 | 3/8 | 11.5 | 20 | 16 | .128 |
| 0910 00 21 | 1/2 | 14 | 25 | 19 | .213 |

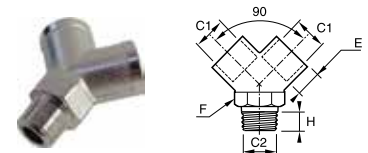

0911 "Y" Connector Female BSPP to Male BSPT

| PART NO. | C1 BSPP | C2 BSPT | E | F | H | WT. |
|------------|---------|---------|------|----|----|------|
| 0911 00 10 | G1/8 | R1/8 | 8 | 13 | 12 | .055 |
| 0911 00 13 | G1/4 | R1/4 | 11 | 17 | 14 | .081 |
| 0911 00 17 | G3/8 | R3/8 | 11.5 | 20 | 16 | .128 |
| 0911 00 21 | G1/2 | R1/2 | 14 | 25 | 19 | .213 |

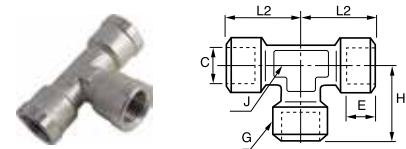

0915 Female Tee BSPP or M5

| PART NO. | C BSPP/M5 | E MM | G MM | H MM | J MM | L2 MM | WT. KG |
|------------|-----------|------|------|------|------|-------|--------|
| 0915 00 19 | M5 | 4 | 8 | 11 | 9 | 11 | .047 |
| 0915 00 10 | G1/8 | 8 | 13 | 21 | 10 | 21 | .051 |
| 0915 00 13 | G1/4 | 11 | 17 | 25.5 | 13 | 25.5 | .074 |
| 0915 00 17 | G3/8 | 11.5 | 21 | 28 | 17 | 28 | .147 |
| 0915 00 21 | G1/2 | 14 | 26 | 33.5 | 21 | 33.5 | .231 |
| 0915 00 27 | G3/4 | 15 | 31 | 36.5 | 27 | 36.5 | .381 |

WARNING These products can expose you to chemicals including LEAD which is known to the state of California to cause cancer and birth defects or other reproductive harm. For more information go to www.P65Warnings.ca.gov.



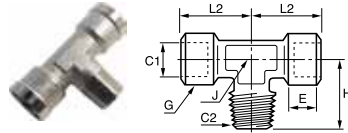

0916 / 0923 Branch Tee Female BSPP to Male BSPT

| PART NO. | C1 BSPP/M5 | C2 BSPT | E MM | G MM | H MM | J MM | L2 MM | WT. KG |
|------------|------------|---------|------|------|------|------|-------|--------|
| 0923 00 19 | M5 | | 4 | 8 | 11 | 9 | 11 | .040 |
| 0916 00 10 | G1/8 | R1/8 | 8 | 13 | 18.5 | 10 | 21 | .045 |
| 0916 00 13 | G1/4 | R1/4 | 11 | 17 | 23.5 | 13 | 25.5 | .071 |
| 0916 00 17 | G3/8 | R3/8 | 11.5 | 21 | 26 | 17 | 28 | .118 |
| 0916 00 21 | G1/2 | R1/2 | 14 | 26 | 31 | 21 | 33.5 | .203 |
| 0916 00 27 | G3/4 | R3/4 | 15 | 31 | 36.5 | 27 | 36.5 | .320 |

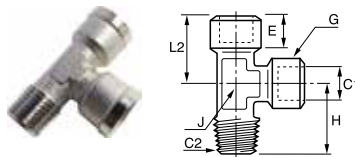

0917 / 0924 Run Tee Female BSPP to Male BSPT or M5

| PART NO. | C1 BSPP/M5 | C2 BSPT | E MM | G MM | H MM | J MM | L2 MM | WT. KG |
|------------|------------|---------|------|------|------|------|-------|--------|
| 0924 00 19 | M5 | | 4 | 8 | 11 | 9 | 11 | .040 |
| 0917 00 10 | G1/8 | R1/8 | 8 | 13 | 18.5 | 10 | 21 | .045 |
| 0917 00 13 | G1/4 | R1/4 | 11 | 17 | 23.5 | 13 | 25.5 | .071 |
| 0917 00 17 | G3/8 | R3/8 | 11.5 | 21 | 26 | 17 | 28 | .118 |
| 0917 00 21 | G1/2 | R1/2 | 14 | 26 | 31 | 21 | 33.5 | .203 |
| 0917 00 27 | G3/4 | R3/4 | 15 | 31 | 36.5 | 27 | 36.5 | .320 |

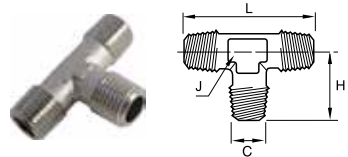

0927 Equal Male Tee BSPT

| PART NO. | C BSPT | H MM | J MM | L MM | WT. KG |
|------------|--------|------|------|------|--------|
| 0927 00 10 | R1/8 | 18.5 | 10 | 37 | .017 |
| 0927 00 13 | R1/4 | 23.5 | 13 | 47 | .038 |
| 0927 00 17 | R3/8 | 26 | 17 | 52 | .057 |
| 0927 00 21 | R1/2 | 31 | 21 | 62 | .093 |

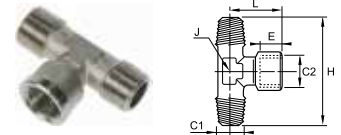

0928 Male Stud Branch Tee BSPT Female BSPP

| PART NO. | C1 BSPT | C2 BSPP | E MM | H MM | J MM | L MM | WT. KG |
|------------|---------|---------|------|------|------|------|--------|
| 0928 00 10 | R1/8 | G1/8 | 8 | 37 | 10 | 21 | 0.021 |
| 0928 00 13 | R1/4 | G1/4 | 11 | 47 | 13 | 25.5 | 0.044 |
| 0928 00 17 | R3/8 | G3/8 | 11.5 | 52 | 17 | 28 | 0.066 |
| 0928 00 21 | R1/2 | G1/2 | 14 | 62 | 21 | 33.5 | 0.109 |

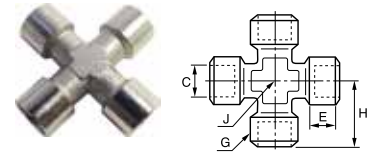

0908 Cross Female BSPP

| PART NO. | C BSPP | E MM | G MM | H MM | J MM | WT. KG |
|------------|--------|------|------|------|------|--------|
| 0908 00 10 | G1/8 | 8 | 13 | 21 | 10 | .055 |
| 0908 00 13 | G1/4 | 11 | 17 | 25.5 | 13 | .081 |
| 0908 00 17 | G3/8 | 11.5 | 21 | 28 | 17 | .128 |
| 0908 00 21 | G1/2 | 14 | 26 | 33.5 | 21 | .213 |

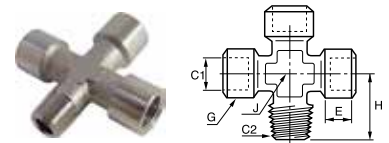

0909 Cross Female BSPP to Male BSPT

| PART NO. | C1 BSPP | C2 BSPT | E MM | G MM | H MM | J MM | WT. KG |
|------------|---------|---------|------|------|------|------|--------|
| 0909 00 10 | G1/8 | R1/8 | 8 | 13 | 18.5 | 10 | .055 |
| 0909 00 13 | G1/4 | R1/4 | 11 | 17 | 23.5 | 13 | .081 |
| 0909 00 17 | G3/8 | R3/8 | 11.5 | 21 | 26 | 17 | .128 |
| 0909 00 21 | G1/2 | R1/2 | 14 | 26 | 31 | 21 | .213 |

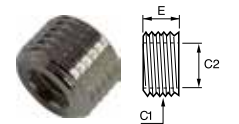

0903 Adapter Reducer BSPP

| PART NO. | C1 BSPP | C2 BSPP | E MM | WT. KG |
|------------|---------|---------|------|--------|
| 0903 10 13 | G1/4 | G1/8 | 8 | .009 |
| 0903 13 17 | G3/8 | G1/4 | 9 | .020 |
| 0903 17 21 | G1/2 | G3/8 | 10 | .025 |
| 0903 21 27 | G3/4 | G1/2 | 14 | .048 |
| 0903 27 34 | G1" | G3/4 | 20 | .060 |

WARNING These products can expose you to chemicals including LEAD which is known to the state of California to cause cancer and birth defects or other reproductive harm. For more information go to www.P65Warnings.ca.gov.

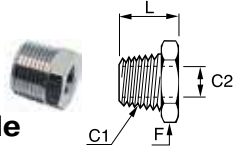

0904 Adapter Reducer Female BSPP to Male BSPT

| PART NO. | C1 BSPT | C2 BSPP | F MM | L MM | WT. KG |
|------------|---------|---------|------|------|--------|
| 0904 10 13 | R1/4 | G1/8 | 14 | 16 | .009 |
| 0904 10 17 | R3/8 | G1/8 | 17 | 16.5 | .020 |
| 0904 13 17 | R3/8 | G1/4 | 17 | 16.5 | .012 |
| 0904 13 21 | R1/2 | G1/4 | 22 | 19.5 | .038 |
| 0904 17 21 | R1/2 | G3/8 | 22 | 19.5 | .025 |
| 0904 17 27 | R3/4 | G3/8 | 27 | 23.5 | .069 |
| 0904 21 27 | R3/4 | G1/2 | 27 | 23.5 | .048 |

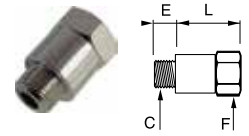

0907 Extended Adapter BSPP

| PART | C BSPP | E MM | F MM | L MM | WT. KG |
|---------------|--------|------|------|------|--------|
| 0907 00 10 | G1/8 | 6 | 14 | 16 | .009 |
| 0907 00 10 01 | G1/8 | 6 | 14 | 36 | .009 |
| 0907 00 13 | G1/4 | 8 | 17 | 23 | .020 |
| 0907 00 13 01 | G1/4 | 8 | 17 | 43 | .020 |

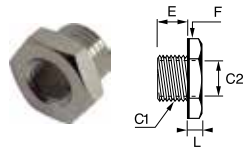

0905 Adapter Reducer Male BSPP to Female BSPP or M5

| PART NO. | C1 BSPP | C2 BSPP M5 | E MM | F MM | L MM | WT. KG |
|------------|---------|------------|------|------|------|--------|
| 0905 19 10 | G1/8 | M5 | 6 | 14 | 4.5 | .009 |
| 0905 10 13 | G1/4 | G1/8 | 8 | 17 | 5 | .009 |
| 0905 10 17 | G3/8 | G1/8 | 9 | 19 | 5 | .020 |
| 0905 13 17 | G3/8 | G1/4 | 9 | 19 | 5 | .012 |
| 0905 13 21 | G1/2 | G1/4 | 10 | 24 | 5.5 | .038 |
| 0905 17 21 | G1/2 | G3/8 | 10 | 24 | 5.5 | .025 |
| 0905 17 27 | G3/4 | G3/8 | 12 | 30 | 5.5 | .069 |
| 0905 21 27 | G3/4 | G1/2 | 12 | 30 | 5.5 | .048 |

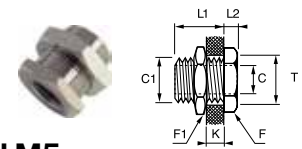

0920 Bulkhead BSPP and M5

| PART NO. | C1 METRIC | C BSPP M5 | F MM | F1 MM | K MAX MM | L1 MM | L2 MM | T MIN MM | WT. KG |
|------------|-----------|-----------|------|-------|----------|-------|-------|----------|--------|
| 0920 00 19 | M10X1 | M5 | 14 | 14 | 7 | 10.5 | 3.5 | 10.5 | .013 |
| 0920 00 10 | M16X1.5 | G1/8 | 19 | 22 | 9 | 14 | 4 | 16.5 | .033 |
| 0920 00 13 | M20X1.5 | G1/4 | 24 | 27 | 15 | 21 | 4 | 20.5 | .057 |
| 0920 00 17 | M26X1.5 | G3/8 | 30 | 32 | 14 | 21 | 5 | 26.5 | .096 |
| 0920 00 21 | M28X1.5 | G1/2 | 32 | 36 | 20 | 27 | 6 | 28.5 | .117 |

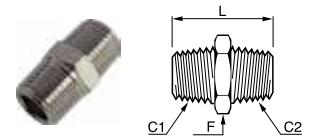

0900 Male Straight Adapter BSPT

| PART NO. | C1 BSPT | C2 BSPT | F MM | L MM | WT. KG |
|------------|---------|---------|------|------|--------|
| 0900 00 10 | R1/8 | R1/8 | 12 | 19.5 | .009 |
| 0900 10 13 | R1/8 | R1/4 | 14 | 23.5 | .021 |
| 0900 00 13 | R1/4 | R1/4 | 14 | 27 | .021 |
| 0900 10 17 | R1/8 | R3/8 | 17 | 24 | .022 |
| 0900 13 17 | R1/4 | R3/8 | 17 | 27.5 | .024 |
| 0900 00 17 | R3/8 | R3/8 | 17 | 28 | .025 |
| 0900 13 21 | R1/4 | R1/2 | 22 | 30.5 | .045 |
| 0900 17 21 | R3/8 | R1/2 | 22 | 31 | .045 |
| 0900 00 21 | R1/2 | R1/2 | 22 | 33.5 | .055 |
| 0900 21 27 | R1/2 | R3/4 | 27 | 37.5 | .084 |
| 0900 00 27 | R3/4 | R3/4 | 27 | 40 | .092 |
| 0900 27 34 | R3/4 | R1 | 34 | 43 | .143 |
| 0900 00 34 | R1 | R1 | 34 | 45.5 | .156 |

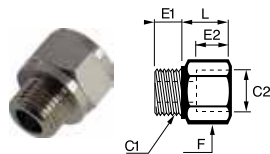

0906 Expander Female BSPP to Male BSPP

| PART NO. | C1 BSPP/M5 | C2 BSPP | E1 MM | E2 MM | F MM | L MM | WT. KG |
|------------|------------|---------|-------|-------|------|------|--------|
| 0906 10 19 | M5 | G1/8 | 4 | 8 | 14 | 10 | .009 |
| 0906 00 10 | G1/8 | G1/8 | 6 | 8.5 | 14 | 10 | .009 |
| 0906 10 13 | G1/8 | G1/4 | 6 | 11.5 | 17 | 14 | .020 |
| 0906 10 17 | G1/8 | G3/8 | 6 | 11.5 | 22 | 14.5 | .038 |
| 0906 00 13 | G1/4 | G1/4 | 8 | 11.5 | 17 | 14 | .040 |
| 0906 13 17 | G1/4 | G3/8 | 8 | 11.5 | 22 | 14.5 | .042 |
| 0906 13 21 | G1/4 | G1/2 | 8 | 15 | 27 | 18 | .061 |
| 0906 00 17 | G3/8 | G3/8 | 9 | 11.5 | 22 | 14.5 | .061 |
| 0906 17 21 | G3/8 | G1/2 | 9 | 15 | 27 | 18 | .062 |
| 0906 00 21 | G1/2 | G1/2 | 10 | 15 | 27 | 18 | .070 |

WARNING These products can expose you to chemicals including LEAD which is known to the state of California to cause cancer and birth defects or other reproductive harm. For more information go to www.P65Warnings.ca.gov.



- A
- B
- C
- D
- E
- F
- G
- H
- I
- J
- K
- L
- M
- N
- O

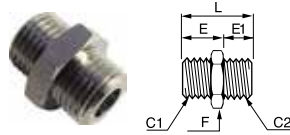

0901 Male Straight Adapter M5 or BSPP

| PART NO. | C1 BSPP M5 | C2 BSPP M5 | E MM | E1 MM | F MM | L MM | WT. KG |
|------------|------------|------------|------|-------|------|------|--------|
| 0901 00 19 | M5 | M5 | 4 | 4 | 8 | 11.5 | .002 |
| 0901 19 10 | M5 | G1/8 | 4 | 6 | 14 | 14.5 | .008 |
| 0901 00 10 | G1/8 | G1/8 | 6 | 6 | 14 | 16.5 | .008 |
| 0901 10 13 | G1/8 | G1/4 | 6 | 8 | 17 | 19 | .014 |
| 0901 00 13 | G1/4 | G1/4 | 8 | 8 | 17 | 21 | .016 |
| 0901 13 17 | G1/4 | G3/8 | 8 | 9 | 19 | 22 | .021 |
| 0901 00 17 | G3/8 | G3/8 | 9 | 9 | 19 | 23 | .024 |

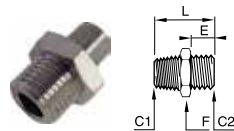

0192 Male Straight Adapter BSPT to BSPP

| PART NO. | C1 BSPT | C2 BSPP | E MM | F MM | L MM | WT. KG |
|------------|---------|---------|------|------|------|--------|
| 0192 10 13 | R1/8 | G1/4 | 9.5 | 17 | 23.5 | .019 |
| 0192 13 13 | R1/4 | G1/4 | 9.5 | 17 | 27.5 | .024 |
| 0192 13 21 | R1/4 | G1/2 | 27 | 27 | 31.5 | .067 |
| 0192 17 13 | R3/8 | G1/4 | 9.5 | 17 | 45 | .025 |
| 0192 17 21 | R3/8 | G1/2 | 27 | 27 | 31.5 | .061 |
| 0192 21 21 | R1/2 | G1/2 | 27 | 27 | 34 | .060 |

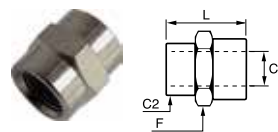

0902 Female Sleeve BSPP and M5

| PART NO. | C1 BSPP/M5 | C2 BSPP/M5 | F MM | L MM | WT. KG |
|------------|------------|------------|------|------|--------|
| 0902 00 19 | M5 | M5 | 8 | 11 | .009 |
| 0902 19 10 | M5 | G1/8 | 14 | 13 | .009 |
| 0902 00 10 | G1/8 | G1/8 | 14 | 15 | .015 |
| 0902 10 13 | G1/8 | G1/4 | 17 | 19.5 | .020 |
| 0902 00 13 | G1/4 | G1/4 | 17 | 22 | .025 |
| 0902 10 17 | G1/8 | G3/8 | 22 | 20 | .030 |
| 0902 13 17 | G1/4 | G3/8 | 22 | 23 | .040 |
| 0902 00 17 | G3/8 | G3/8 | 22 | 24 | .045 |
| 0902 13 21 | G1/4 | G1/2 | 27 | 27 | .050 |
| 0902 17 21 | G3/8 | G1/2 | 27 | 27.5 | .060 |
| 0902 00 21 | G1/2 | G1/2 | 27 | 30 | .084 |
| 0902 21 27 | G1/2 | G3/4 | 30 | 30 | .090 |
| 0902 00 27 | G3/4 | G3/4 | 30 | 32 | .109 |

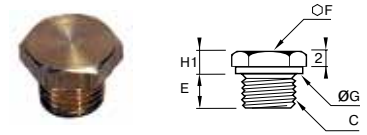

0200 Hex Head Plug BSPP and Metric

| PART NO. | C BSPP | E MM | F MM | G MM | H1 MM | H2 MM | WT. KG |
|------------|--------|------|------|------|-------|-------|--------|
| 0200 10 00 | G1/8 | 7 | 14 | 13.7 | 5.5 | 4 | .012 |
| 0200 13 00 | G1/4 | 8.5 | 17 | 16.7 | 5.5 | 4 | .019 |

| PART NO. | C METRIC | E MM | F MM | G MM | H1 MM | H2 MM | WT. KG |
|------------|----------|------|------|------|-------|-------|--------|
| 0200 52 00 | M6X1 | 6 | 10 | 10 | 4 | 3.5 | .004 |
| 0200 57 00 | M8X1.25 | 7 | 13 | 13 | 4 | 3.5 | .007 |
| 0200 60 00 | M10X1 | 8 | 14 | 14 | 5 | 4.5 | .012 |
| 0200 65 00 | M12X1 | 9 | 17 | 17 | 5 | 4.5 | .018 |
| 0200 66 00 | M10X1.25 | 9 | 17 | 17 | 5 | 4.5 | .018 |

Parallel metric threads ISO – standards NFE 03-054 and BNA 541. Parallel metric threads – standards NFE 03-005 and BNA 541.

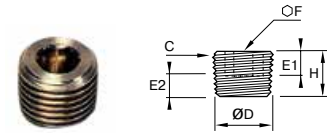

0205 Internal Hex Head Plug NPT and BSPT

| PART NO. | C NPT | OD IN | E1 IN | E2 MIN IN | E2 MAX IN | F IN | H IN | WT. OZ |
|------------|-------|-------|-------|-----------|-----------|------|------|--------|
| 0205 11 00 | 1/8 | .40 | .24 | .12 | .20 | .79 | .31 | .141 |
| 0205 14 00 | 1/4 | .54 | .31 | .17 | .28 | .94 | .39 | .282 |
| 0205 18 00 | 3/8 | .67 | .31 | .18 | .29 | 1.22 | .43 | .494 |
| 0205 22 00 | 1/2 | .93 | .31 | .25 | .39 | 1.53 | .51 | .917 |
| 0205 28 00 | 3/4 | 1.04 | .43 | .27 | .41 | 2.16 | .67 | 1.834 |
| 0205 35 00 | 1 | 1.31 | .51 | .31 | .49 | 2.95 | .75 | 3.245 |

| PART NO. | C BSPT | OD MM | E1 MM | E2 MIN MM | E2 MAX MM | F MM | H MM | WT. KG |
|------------|--------|--------|-------|-----------|-----------|------|------|--------|
| 0205 10 00 | R1/8 | 9.728 | 6 | 3.1 | 4.9 | 5 | 8 | .004 |
| 0205 13 00 | R1/4 | 13.157 | 8 | 4.7 | 7.3 | 6 | 10 | .008 |
| 0205 17 00 | R3/8 | 16.662 | 8 | 5.1 | 7.7 | 8 | 11 | .014 |
| 0205 21 00 | R1/2 | 20.955 | 8 | 6.4 | 10 | 10 | 13 | .027 |
| 0205 27 00 | R3/4 | 26.441 | 11 | 7.7 | 11.3 | 14 | 17 | .053 |
| 0205 34 00 | R1 | 33.249 | 13 | 8.1 | 12.7 | 17 | 19 | .092 |
| 0205 42 00 | R1-1/4 | 41.910 | 14 | 10.4 | 15 | 22 | 22 | .183 |
| 0205 49 00 | R1-1/2 | 47.803 | 14 | 10.4 | 15 | 24 | 22 | .250 |
| 0205 48 00 | R2 | 59.614 | 16 | 13.6 | 18.2 | 30 | 25 | .440 |

For BSP taper plus 1/2" - 1 1/2" inclusive - thread standard NFE 03-004 - DIN906

WARNING These products can expose you to chemicals including LEAD which is known to the state of California to cause cancer and birth defects or other reproductive harm. For more information go to www.P65Warnings.ca.gov.

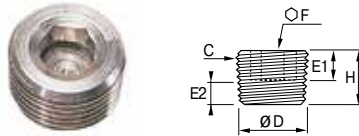

0285 Internal Hex Head Plug NPT or BSPT

| PART NO. | C NPT | OD IN | E1 IN | E2 MIN IN | E2 MAX IN | F MM | H IN | WT. OZ |
|------------|-------|-------|-------|-----------|-----------|------|------|--------|
| 0285 11 00 | 1/8 | .40 | .24 | .13 | .20 | 5 | .31 | .14 |
| 0285 14 00 | 1/4 | .54 | .31 | .17 | .28 | 6 | .39 | .25 |
| 0285 18 00 | 3/8 | .67 | .31 | .19 | .30 | 8 | .43 | .49 |
| 0285 22 00 | 1/2 | .84 | .31 | .25 | .39 | 10 | .51 | .88 |

| PART NO. | C BSPT | OD MM | E1 MM | E2 MIN MM | E2 MAX MM | F MM | H MM | WT. KG |
|------------|--------|-------|-------|-----------|-----------|------|------|--------|
| 0285 10 00 | R1/8 | 9.72 | 6 | 3.1 | 4.9 | 5 | 8 | .003 |
| 0285 13 00 | R1/4 | 13.15 | 8 | 4.7 | 7.3 | 6 | 10 | .007 |
| 0285 17 00 | R3/8 | 16.66 | 8 | 5.1 | 7.7 | 8 | 11 | .013 |
| 0285 21 00 | R1/2 | 20.95 | 8 | 6.4 | 10 | 10 | 13 | .025 |
| 0285 27 00 | R3/4 | 26.44 | 11 | 7.7 | 11.3 | 14 | 17 | .057 |
| 0285 34 00 | R1 | 33.25 | 13 | 8.1 | 12.7 | 17 | 19 | .098 |

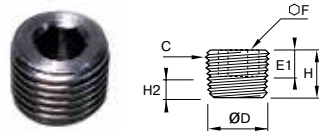

0206 Internal Hex Head NPT and BSPT

| PART NO. | C NPT | OD IN | E1 IN | E2 MIN IN | E2 MAX IN | F MM | H IN | WT. OZ |
|------------|-------|-------|-------|-----------|-----------|------|------|--------|
| 0206 08 00 | 1/16 | .31 | .24 | .15 | .25 | .16 | .26 | .070 |
| 0206 11 00 | 1/8 | .40 | .24 | .12 | .20 | .20 | .31 | .106 |
| 0206 14 00 | 1/4 | .54 | .31 | .17 | .28 | .24 | .39 | .247 |
| 0206 18 00 | 3/8 | .67 | .31 | .18 | .29 | .31 | .43 | .423 |
| 0206 22 00 | 1/2 | .83 | .31 | .25 | .39 | .39 | .51 | .847 |
| 0206 28 00 | 3/4 | 1.04 | .43 | .27 | .41 | .55 | .67 | 1.658 |
| 0206 25 00 | 1 | 1.31 | .51 | .31 | .49 | .67 | .75 | 2.928 |

| PART NO. | C BSPT | OD MM | E1 MM | E2 MIN MM | E2 MAX MM | F MM | H MM | WT. KG |
|------------|--------|--------|-------|-----------|-----------|------|------|--------|
| 0285 10 00 | R1/8 | 9.728 | 6 | 3.1 | 4.9 | 5 | 8 | .003 |
| 0285 13 00 | R1/4 | 13.157 | 8 | 4.7 | 7.3 | 6 | 10 | .007 |
| 0285 17 00 | R3/8 | 16.662 | 8 | 5.1 | 7.7 | 8 | 11 | .013 |
| 0285 21 00 | R1/2 | 20.955 | 8 | 6.4 | 10 | 10 | 13 | .024 |
| 0285 27 00 | R3/4 | 26.441 | 11 | 7.7 | 11.3 | 14 | 17 | .048 |
| 0285 34 00 | R1 | 33.249 | 13 | 8.1 | 12.7 | 17 | 19 | .086 |
| 0285 34 00 | R1-1/4 | 41.910 | 14 | 10.4 | 15 | 22 | 22 | .162 |
| 0285 34 00 | R1-1/2 | 47.803 | 14 | 10.4 | 15 | 24 | 22 | .222 |

For BSP taper plugs 1/2" - 1 1/2" inclusive - conform to standard BNA 247 - thread - DIN 906 standard NFE 03-004

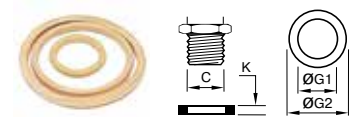

0138 Copper Washer BSPP and Metric

| PART NO. | C BSPP/M5 | G1 MM | G2 MM | K MM | WT. OZ |
|----------|-----------|-------|-------|------|--------|
| | M6 | 6.3 | 9 | 1 | .033 |
| | M8 | 8.3 | 11 | 1 | .001 |
| | M12 | 12.3 | 15.5 | 1.5 | .072 |
| | M14 | 14.3 | 18 | 1.5 | .001 |
| | M16 | 16.3 | 20 | 1.5 | .001 |
| | M18 | 18.3 | 22 | 1.5 | .001 |
| | M20 | 20.3 | 24 | 1.5 | .001 |
| | M22 | 22.3 | 27 | 1.5 | .002 |
| | M24 | 24.3 | 29 | 2 | .003 |
| | M26 | 26.3 | 31 | 2 | .003 |
| | M30 | 30.3 | 36 | 2 | .004 |
| | M36 | 36.3 | 42 | 2 | .005 |
| | M39 | 39.3 | 44 | 2 | .007 |
| | M45 | 45.3 | 52 | 2 | .007 |
| | M52 | 52.3 | 60 | 2 | .009 |
| | G1/8 | 10.3 | 13.5 | 1 | .001 |
| | G1/4 | 13.5 | 18 | 1.3 | .001 |
| | G3/8 | 17.3 | 21 | 1.5 | .001 |
| | G1/2 | 21.3 | 26 | 1.5 | .002 |
| | G3/4 | 27.3 | 32 | 2 | .003 |
| | G1 | 33.5 | 39 | 2 | .005 |
| | G1-1/4 | 42.5 | 49 | 2 | .007 |
| | G1-1/2 | 48.3 | 55 | 2 | .008 |
| | G2 | 60 | 68 | 2.5 | .014 |

WARNING These products can expose you to chemicals including LEAD which is known to the state of California to cause cancer and birth defects or other reproductive harm. For more information go to www.P65Warnings.ca.gov.



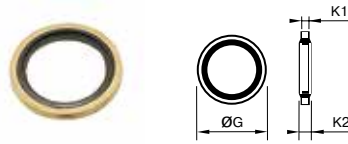

0139 Bi-Material Captive Sealing Washer BSPP

| PART NO. | C BSPP | G MM | G2 MM | K MM | WT. OZ |
|------------|--------|------|-------|------|--------|
| 0139 10 00 | G1/8 | 14 | 1 | 1.8 | .001 |
| 0139 13 00 | G1/4 | 17 | 1 | 1.8 | .001 |
| 0139 17 00 | G3/8 | 22 | 1.3 | 2.1 | .001 |
| 0139 21 00 | G1/2 | 26 | 1.6 | 2.4 | .002 |
| 0139 27 00 | G3/4 | 32 | 1.6 | 2.4 | .002 |
| 0139 34 00 | G1 | 43 | 3.5 | 2.5 | .002 |

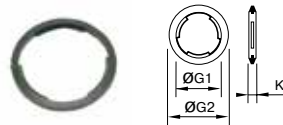

0602 Captive Sealing Washer BSPP and M5

| PART NO. | C BSPP/M5 | G1 MM | G2 MM | K MM | WT. OZ |
|---------------|-----------|-------|-------|------|--------|
| 0602 29 93 15 | M5X0.8 | 5.2 | 7.8 | 1.5 | .001 |
| 0602 23 10 20 | G1/8 | 10.3 | 14 | 2 | .001 |
| 0602 23 11 20 | G1/4 | 13.7 | 17.5 | 2 | .001 |
| 0602 23 12 20 | G3/8 | 17.2 | 21 | 2 | .001 |
| 0602 23 13 20 | G1/2 | 21.5 | 25.5 | 2.5 | .001 |
| 0602 27 32 20 | G3/4 | 27 | 32 | 2.5 | .001 |
| 0602 30 60 20 | G1 | 33.8 | 39 | 3 | .001 |

WARNING These products can expose you to chemicals including LEAD which is known to the state of California to cause cancer and birth defects or other reproductive harm. For more information go to www.P65Warnings.ca.gov.





ISO Port Adapters

Parker's ISO Port Adapters meet dimensional requirements of ISO 6149-3.

Product Features:

- All brass construction
- Fluorocarbon O-ring
- NPTF, flare, hose barb, NTA end configurations

Markets:

- Industrial
- Construction
- Mobile
- Factory/process automation

Applications:

- Air Lines
- Water Line
- Cooling Line

Specifications:

Pressure Range Dependent on tubing or hose end connection

Temperature Range Dependent on tubing or hose end connection

A

B

C

D

E

F

G

H

I

J

K

L

M

N

O

WARNING These products can expose you to chemicals including LEAD which is known to the state of California to cause cancer and birth defects or other reproductive harm. For more information go to www.P65Warnings.ca.gov.



Click here for CADs, Product Specifications or to Configure Parts Online

- A
- B
- C
- D
- E
- F
- G
- H
- I
- J
- K
- L
- M
- N
- O

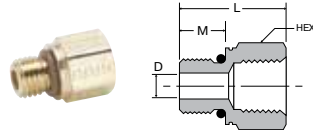

Pipe to Metric Adaptor 222P-X-MIX

| PART NUMBER | NPTF | METRIC THREAD | HEX | L | M | D |
|-------------|--------|---------------|--------|------|-----|-----|
| 222P-2-MI10 | 1/8-27 | M10 X 1.0 | 9/16 | .75 | .34 | .18 |
| 222P-2-MI14 | 1/8-27 | M14 X 1.5 | 3/4 | .91 | .43 | .30 |
| 222P-4-MI12 | 1/4-18 | M12 X 1.5 | 11/16 | 1.09 | .43 | .24 |
| 222P-4-MI14 | 1/4-18 | M14 X 1.5 | 3/4 | 1.09 | .43 | .30 |
| 222P-6-MI16 | 3/8-18 | M16 X 1.5 | 7/8 | 1.16 | .45 | .35 |
| 222P-6-MI22 | 3/8-18 | M22 X 1.5 | 1 1/16 | 1.05 | .51 | .47 |
| 222P-8-MI27 | 1/2-14 | M27 X 2.0 | 1 1/4 | 1.32 | .63 | .60 |

Note: Fluorocarbon o-ring is standard
For working pressure and Temperature see Metric Adapters Section

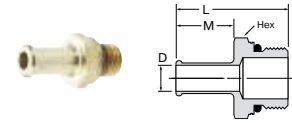

Hose Barb to Metric Adaptor 68HB-X-MIX

| PART NUMBER | TUBE SIZE | METRIC THREAD | HEX | L | M | D |
|--------------|-----------|---------------|-------|------|-----|-----|
| 68HB-6-MI12 | 3/8 | M12 X 1.5 | 11/16 | 1.50 | .78 | .24 |
| 68HB-6-MI14 | 3/8 | M14 1.5 | 3/4 | 1.51 | .78 | .30 |
| 68HB-8-MI12 | 1/2 | M12 X 1.5 | 11/16 | 1.50 | .78 | .24 |
| 68HB-10-MI27 | 5/8 | M27 X 2.0 | 1 1/4 | 1.77 | .78 | .50 |

Note: Fluorocarbon o-ring is standard
For working pressure and Temperature see Hose Barb Section

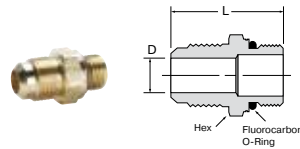

Flare to Metric Adaptor 48F-X-MIX

| PART NUMBER | TUBE SIZE | METRIC THREAD | HEX | L | D |
|-------------|-----------|---------------|-------|------|-----|
| 48F-8-MI16 | 1/2 | M16 X 1.5 | 7/8 | 1.60 | .35 |
| 48F-10-MI27 | 5/8 | M27 X 2.0 | 1 1/4 | 1.87 | .50 |
| 48F-12-MI27 | 3/4 | M27 X 2.0 | 1 1/4 | 1.99 | .63 |

Note: Fluorocarbon o-ring is standard
For working pressure and Temperature see SAE Flare Section

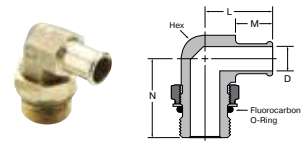

Beaded Elbow to Metric Adaptor 169HB-X-MIX

| PART NUMBER | HOSE SIZE | METRIC THREAD | HEX | L | M | N | D |
|---------------|-----------|---------------|-----|------|-----|------|-----|
| 169HB-10-MI27 | 5/8 | M27 X 2.0 | 7/8 | 1.41 | .78 | 1.63 | .50 |
| 169HB-16-MI27 | 1 | M27 X 2.0 | 1 | 1.67 | .97 | 1.68 | .71 |

Note: Fluorocarbon o-ring is standard
For working pressure and Temperature see Hose Barb Section

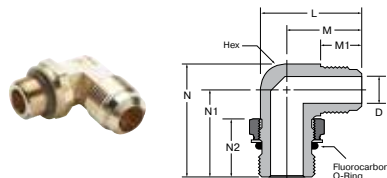

Flare Elbow to Metric Adaptor 149F-X-MIX

| PART NUMBER | TUBE SIZE | METRIC THREAD | HEX | L | M | M1 | N | N1 | N2 | D |
|--------------|-----------|---------------|-----|------|------|-----|------|------|------|-----|
| 149F-10-MI27 | 5/8 | M27 X 2.0 | 7/8 | 1.95 | 1.46 | .88 | 2.12 | 1.63 | 1.09 | .50 |

Note: Fluorocarbon o-ring is standard
For working pressure and Temperature see SAE Flare Section

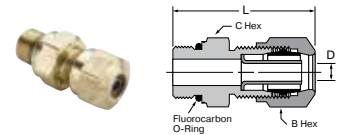

NTA to Metric Adaptor 68NTA-X-MIX

| PART NUMBER | TUBE SIZE | METRIC THREAD | B HEX | C HEX | L | D |
|--------------|-----------|---------------|-------|-------|------|------|
| 68NTA-4-MI10 | 1/4 | M10 X 1.0 | 9/16 | 9/16 | 1.33 | .140 |

Note: Fluorocarbon o-ring is standard
For working pressure and Temperature see Air Brake-NTA Section

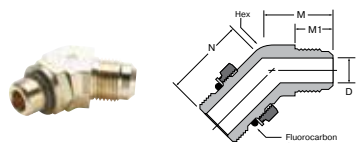

45° Flare Elbow to Metric Adaptor 159F-X-MIX

| PART NUMBER | TUBE SIZE | METRIC THREAD | HEX | M | M1 | N | D |
|--------------|-----------|---------------|-------|------|-----|------|-----|
| 159F-8-MI16 | 1/2 | M16 X 1.5 | 13/16 | 1.10 | .75 | 1.16 | .36 |
| 159F-10-MI27 | 5/8 | M27 X 2.0 | 1 1/8 | 1.21 | .88 | 1.50 | .50 |

Note: Fluorocarbon o-ring is standard
For working pressure and Temperature see SAE Flare Section

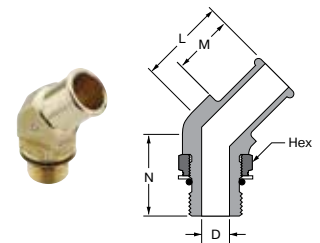

Beaded Hose Barb 45° Elbow to Metric Thread 179HB-X-MIX

| PART NUMBER | HOSE SIZE | METRIC THREAD | HEX | L | M | N | D |
|---------------|-----------|---------------|--------|------|-----|------|-----|
| 179HB-12-MI18 | 3/4 | M18 X 1.5 | 13/16 | 1.15 | .78 | 1.16 | .44 |
| 179HB-16-MI27 | 1 | M27 X 2.0 | 1 1/16 | 1.51 | .97 | 1.71 | .71 |

Note: Fluorocarbon o-ring is standard

WARNING These products can expose you to chemicals including LEAD which is known to the state of California to cause cancer and birth defects or other reproductive harm. For more information go to www.P65Warnings.ca.gov.



- A
- B
- C
- D
- E
- F
- G
- H
- I
- J
- K
- L
- M
- N
- O



Garden Hose Fittings

Parker's Garden Hose Fittings connect garden hose to other garden hose, to pipe or to tubing. Swivel connections allow hose to twist without kinking.

Product Features:

- All brass construction
- 3/4" garden hose thread
- Rubber washer
- Flare, hose barb and pipe end configurations
- High Flow couplings

Markets:

- Industrial
- Mobile
- Factory/process automation

Applications:

- Water Line

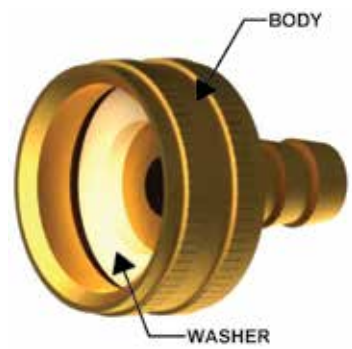

Specifications:

| | |
|--------------------------|---|
| Pressure Range | Up to 150 PSI (10.3 bar) |
| <hr/> | |
| Temperature Range | +35° to +100° F at 75 PSI (+1.6° to +37.7° C at 5.1 bar) |
| <hr/> | |

Compatible Tubing:

- Garden Hose

Note: 90Gh is intended for use with the 97HC hose clamp or crimped ferrule. All female connector ends should have a rubber washer(901GH-12) inserted prior to use.

WARNING These products can expose you to chemicals including CARBON BLACK, or LEAD, which are known to the state of California to cause cancer, and LEAD which is known to cause birth defects or other reproductive harm. For more information go to www.P65Warnings.ca.gov.

[Click here for CADs, Product Specifications or to Configure Parts Online](#)

Swivel Connector SAE Flare to Female Hose Thread 50GHSV

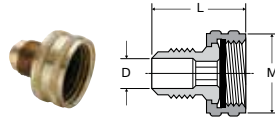

| PART NO. | TUBE SIZE | HOSE THREAD | L | M | FLOW DIA. D |
|-------------|-----------|-------------|------|------|-------------|
| 50GHSV-6-12 | 3/8 | 3/4 | 1.25 | 1.15 | .297 |
| 50GHSV-8-12 | 1/2 | 3/4 | 1.34 | 1.15 | .406 |

Hose Barb to Male Hose Thread 53GH, 54GH & 55GH

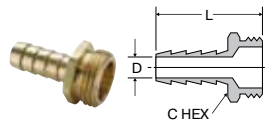

| PART NO. | I.D. HOSE SIZE | HOSE THREAD | C HEX | L | FLOW DIA. D |
|------------|----------------|-------------|--------|------|-------------|
| 53GH-8-12 | 1/2 | 3/4 | 1-1/16 | 1.88 | .375 |
| 54GH-10-12 | 5/8 | 3/4 | 1-1/16 | 1.88 | .500 |
| 55GH-12-12 | 3/4 | 3/4 | 1-1/16 | 1.88 | .625 |

Male Hose to Male Pipe 69GH, 70GH, 71GH

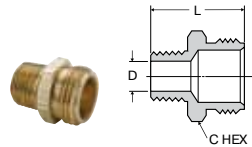

| PART NO. | HOSE THREAD | PIPE THREAD | C HEX | L | FLOW DIA. D |
|------------|-------------|-------------|--------|------|-------------|
| 69GH-12-4 | 3/4 | 1/4 | 1-1/16 | 1.25 | .410 |
| 69GH-12-6 | 3/4 | 3/8 | 1-1/16 | 1.25 | .406 |
| 70GH-12-8 | 3/4 | 1/2 | 1-1/16 | 1.39 | .531 |
| 71GH-12-12 | 3/4 | 3/4 | 1-1/16 | 1.41 | .750 |

Male Hose to Male Hose 75GH

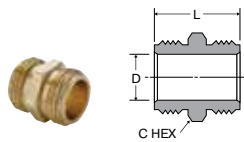

| PART NO. | HOSE THREAD | C HEX | L | FLOW DIA. D |
|----------|-------------|--------|------|-------------|
| 75GH-12 | 3/4 | 1-1/16 | 1.25 | .750 |

Male Hose to Female Pipe 78GH, 79GH, 80GH & 81GH

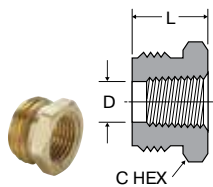

| PART NO. | HOSE THREAD | PIPE THREAD | C HEX | L | FLOW DIA. D |
|------------|-------------|-------------|--------|------|-------------|
| 78GH-12-4 | 3/4 | 1/4 | 1-1/16 | .75 | .422 |
| 79GH-12-6 | 3/4 | 3/8 | 1-1/16 | .75 | .562 |
| 80GH-12-8 | 3/4 | 1/2 | 1-1/16 | .75 | .687 |
| 81GH-12-12 | 3/4 | 3/4 | 1-3/16 | 1.28 | .719 |

Female Hose to Male Pipe 82GH & 83GH

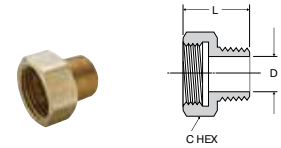

| PART NO. | HOSE THREAD | PIPE THREAD | C HEX | L | FLOW DIA. D |
|------------|-------------|-------------|--------|------|-------------|
| 82GH-12-8 | 3/4 | 1/2 | 1-3/16 | 1.20 | .562 |
| 83GH-12-12 | 3/4 | 3/4 | 1-3/16 | 1.22 | .750 |

Swivel Connector Female Garden Hose to Male Pipe 88GH

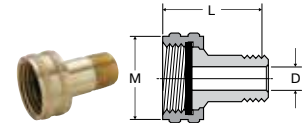

| PART NO. | HOSE THREAD | PIPE THREAD | L | M | FLOW DIA. D |
|-----------|-------------|-------------|------|------|-------------|
| 88GH-12-4 | 3/4 | 1/4 | 1.69 | 1.15 | .312 |
| 88GH-12-6 | 3/4 | 3/8 | 1.69 | 1.15 | .406 |

Swivel Connector Female Garden Hose to Hose Barb 90GH

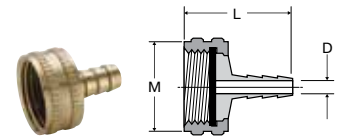

| PART NO. | HOSE THREAD | I.D. HOSE SIZE | L | M | FLOW DIA. D |
|-------------|-------------|----------------|------|------|-------------|
| 90GH-12-3 | 3/4 | 3/16 | 1.29 | 1.15 | .125 |
| 90GH-12-4 | 3/4 | 1/4 | 1.21 | 1.15 | .187 |
| 90GH-12-6 | 3/4 | 3/8 | 1.21 | 1.15 | .281 |
| 90GH-12-8 | 3/4 | 1/2 | 1.21 | 1.15 | .375 |
| 90GH-12-10* | 3/4 | 5/8 | 1.93 | 1.19 | .500 |
| 90GH-12-12* | 3/4 | 3/4 | 1.93 | 1.19 | .625 |

*Denotes hex body

Knurled Hose Nut 94GH

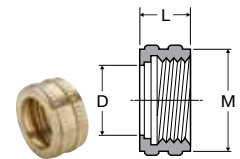

| PART NO. | HOSE THREAD | L | M | FLOW DIA. D |
|----------|-------------|-----|------|-------------|
| 94GH-12 | 3/4 | .57 | 1.15 | .808 |

WARNING These products can expose you to chemicals including CARBON BLACK, or LEAD, which are known to the state of California to cause cancer, and LEAD which is known to cause birth defects or other reproductive harm. For more information go to www.P65Warnings.ca.gov.



Click here for CADs, Product Specifications or to Configure Parts Online

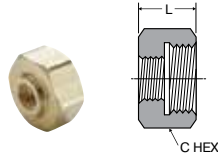

Hose Nut Reducer 95GH

| PART NO. | HOSE THREAD | PIPE THREAD | C HEX | L |
|-----------|-------------|-------------|-------|-----|
| 95GH-12-2 | 3/4 | 1/8 | 1-1/8 | .63 |

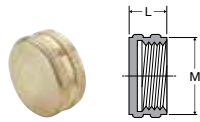

Hose Cap Nut 96GH

| PART NO. | HOSE THREAD | L | M |
|----------|-------------|-----|------|
| 96GH-12 | 3/4 | .50 | 1.15 |

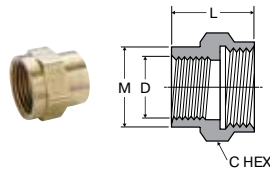

Female Hose to Female Pipe 98GH & 99GH

| PART NO. | HOSE THREAD | PIPE THREAD | C HEX | L | M | FLOW DIA. D |
|------------|-------------|-------------|--------|------|------|-------------|
| 98GH-12-8 | 3/4 | 1/2 | 1-3/16 | 1.14 | 1.01 | .687 |
| 99GH-12-12 | 3/4 | 3/4 | 1-3/16 | 1.25 | 1.17 | .750 |

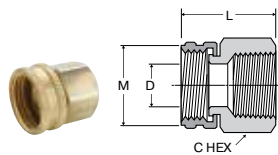

Swivel Connector Female Hose to Female Pipe 98GHSV & 99GHSV

| PART NO. | HOSE THREAD | PIPE THREAD | C HEX | L | M | FLOW DIA. D |
|--------------|-------------|-------------|--------|------|------|-------------|
| 98GHSV-12-8 | 3/4 | 1/2 | 1 | 1.27 | 1.21 | .687 |
| 99GHSV-12-12 | 3/4 | 3/4 | 1-3/16 | 1.34 | 1.21 | .687 |

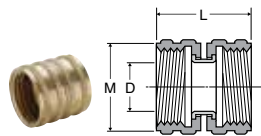

Swivel Nut Connector 101GHSV

| PART NO. | HOSE THREAD | L | M | FLOW DIA. D |
|------------|-------------|------|------|-------------|
| 101GHSV-12 | 3/4 | 1.25 | 1.15 | .625 |



Rubber Garden Hose Coupling Washer 901GH

| PART NO. | HOSE THREAD |
|----------|-------------|
| 901GH-12 | 3/4 |

NOTE: All female connector ends should have this rubber washer

Hydraulic Quick Couplings/ High Flow Couplings

Applications

Parker Water Service Couplings are used anywhere water hoses are connected and disconnected frequently. They are used on a wide variety of applications including garden hoses, wash down systems, and mobile water tank lines. The unvalved design permits maximum flow with minimum pressure drop.

Features

- Brass and stainless steel construction for heavy duty service.
- Durable 4-ball locking mechanism for secure connections.
- Quality, temperature-resistant nitrile seals for a leak-free service life.

Specifications

- Body Size 3/4"
- Rated Pressure PSI 200 (13.7 bar)
- Rated Flow GPM 28
- Temperature Range (std seals) -40° to +250° F (-40° to 121.1° C)

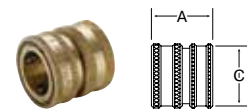

High Flow Coupler 1163-60-BPD

| PART NO. | BODY SIZE | THREAD SIZE NH | A | C |
|-------------|-----------|----------------|------|------|
| 1163-60-BPD | 3/4 | 3/4-11 1/2 | 1.12 | 1.21 |

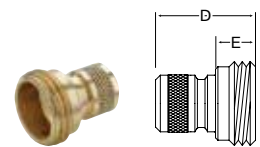

High Flow Nipple 1163-61-BPD

| PART NO. | BODY SIZE | THREAD SIZE NH | D | E |
|-------------|-----------|----------------|------|----|
| 1163-61-BPD | 3/4 | 3/4-11 1/2 | 1.25 | .5 |

WARNING These products can expose you to chemicals including CARBON BLACK, or LEAD, which are known to the state of California to cause cancer, and LEAD which is known to cause birth defects or other reproductive harm. For more information go to www.P65Warnings.ca.gov.





Industrial Valves

Standard Ball Valves

Carbon Steel Ball Valves

Mini Ball Valves

Polypropylene Ball Valves:
LIQUIfit, TrueSeal, and
Par-Barb

Axial Valves

Replacement Componentry

Ball Valve Stem Extensions
Series STX

Needle Valves

Drain Cocks/
Ground Plug Shutoff





Female Ports

V500P

Female-Female
p. K8



V502P

Panel Mount
p. K14



V520P

Economy Series
p. K21



V525P

Female-Female
p. K22



V533P

3 Way Diversion
p. K24



V540P

4 Way
p. K24



V600P

6 Port Diversion
p. K29



V633P

6 Port Diversion
p. K29



V500CS

Carbon Steel
p. K31



V502CS

Panel Mount
Carbon Steel
p. K31



V502SS

Panel Mount
Stainless
p. K39



MV709

Micro Valve
p. K40



MV200

Mini Valve
p. K42



MV609

Mini Valve
p. K42



PV609

Plug Valve
p. K50



4203

Axial Valve-NPT
p. K60



4202

Axial Valve-BSP
p. K60



Male – Male Ports

V591P

90° Valve
p. K26



V591P-X-04

90° Valve
p. K26



PV607

Plug Valve
p. K50



Male – Female Compact High Pressure

XV501PCHP

p. K12



Male-Female Ports

V501P

Male-Female
p. K11



V590P

90° Valve
p. K26



V590P-X-04

90° Valve
p. K26



V501SS

Stainless Steel
p. K37



MV708

Micro Valve
p. K40



MV608

Mini Valve
p. K42



PV608

Plug Valve
p. K50



Barb to Female Port

V500P-HB

Barb to Female Port
p. K27



Solder Ports

V509P

Solder - Solder
p. K17



Straight Thread Ports

V506P

Female - Female
p. K16



V510P

Male - Female
p. K19



V506CS

Carbon Steel
p. K33



Female Ports – High Pressure

V500HP

Female Ports
p. K35



VP500HP

Female Ports-
Padlocking
p. K35



Straight Thread Ports – High Pressure

V506HP

Female Ports
p. K36



VP506HP

Female Ports-
Padlocking
p. K36



WARNING These products can expose you to chemicals including NICKEL, CARBON BLACK, or LEAD, which are known to the state of California to cause cancer, and LEAD which is known to cause birth defects or other reproductive harm. For more information go to www.P65Warnings.ca.gov.



■ Padlocking

VP500P
Female Ports
p. K8



VP501P
Male - Female
p. K12



VP502P
Panel Mount
p. K14



VP510P
Straight Thread
p. K19



VP520P
p. K21



VP500CS
Carbon Steel
p. K31



VP502CS
Panel Mount
p. K31



VP502SS
Stainless Steel
p. K39



■ Tee Handle

V500P-X-04
Female Ports
p. K9



V501P-X-04
Male - Female
p. K12



V502P-X-04
Panel Mount
p. K14



V510P-X-04
Straight Thread
p. K19



V500CS-X-04
Carbon Steel
p. K31



■ Oval Handle

V500P-X-21
Female Ports
p. K9



V501P-X-21
Male - Female
p. K12



V502P-X-21
Panel Mount
p. K14



V510P-X-21
Straight Thread
p. K19



V500CS-X-21
Carbon Steel
p. K32



V502CS-X-21
Panel Mount -
Carbon Steel
p. K32



V502SS-X-21
Oval Handle
p. K39



■ Short Handle

V502SS-X-20
Panel Mount
p. K39



■ Metric Female Ports

BVGL
Female Ports Long
p. K55



BVGTL
Female Ports Long
p. K55



■ Metric Padlocking

BVG4PLOCK
Female Ports
p. K57



■ Vented

VV500P
Female Ports
p. K8



VV501P
Male-Female
p. K12



VV502P
Panel Mount
p. K14



■ Vented – Padlocking

VVP500P
Female Ports
p. K8



VVP501P
Male-Female
p. K12



VVP502P
Panel Mount
p. K14



⚠ WARNING These products can expose you to chemicals including NICKEL, CARBON BLACK, or LEAD, which are known to the state of California to cause cancer, and LEAD which is known to cause birth defects or other reproductive harm. For more information go to www.P65Warnings.ca.gov.



■ Polypropylene Ball Valves

VME
Male Elbow
p. K44



VFE
Female Elbow
p. K44



VUC
Union Connector
p. K44



VEU
Elbow Union
p. K44



VMC
Male Connector
p. K45



VFC
Female Connector
p. K45



VUCPB
Union Connector
p. K45



VAS
Angle Stop
p. K45



VME
Male Elbow
p. K45



VFE
Female Elbow
p. K45



VUC
Union Connector
p. K46



VEU
Elbow Union
p. K46



VTEU
Tube Elbow Union
p. K46



VFC
Female Connector
p. K46



VMC
Male Connector
p. K46



VEU
Parbarb Elbow Ball
Valve
p. K46



VFE
Barbed Female
Elbow
p. K47



VME
Barbed Male Elbow
p. K47



VFC
Barbed Female
Connector
p. K47



VMC
Barbed Male
Connector
p. K47



VUC
Barbed Union
Connector
p. K47



VUCPB
Union Connector
Barbed x Tube
p. K47



BVC
Ball Valve Clip
p. K47



VUC
Valve Union
Connector
p. K48



VMC
Valve Male
Connector
p. K48



VFC
Valve Female
Connector
p. K48



VFE
Valve Female
Elbow
p. K48



VME
Valve Male Elbow
p. K48



VEU
Valve Elbow Union
p. K48



■ Needle Valves

NV101F
Female - Male
p. K65



NV102F
Flare
p. K65



NV103F
Flare - Male Pipe
p. K65



HV104C
Humidifier Valve
p. K65



NV107P
Pipe
p. K66



NV108P
Female - Male
p. K66



NV109P
Female
p. K66



NV311P
Poly-Tite
p. K66



NV312P
Poly-Tite
p. K66



NV104C-NV104CA
Compression - Pipe
p. K65



NV105C-NV105CA
Compression
p. K65



NV106C-NV106CA
Compression - Pipe
p. K66



⚠ WARNING These products can expose you to chemicals including NICKEL, CARBON BLACK, or LEAD, which are known to the state of California to cause cancer, and LEAD which is known to cause birth defects or other reproductive harm. For more information go to www.P65Warnings.ca.gov.

■ **Shutoff Valves**

V203F
Flare
p. K68



V204F
Flare - Pipe
p. K68



V401P
Pipe
p. K68



V402P
Female - Pipe
p. K68



V403P
Female
p. K68



V406P
3 Way
p. K68



V407P
4 Way
p. K68



V303C-V303CA
Compression
p. K68



V304C-V304CA
Compression - Pipe
p. K68



DC601
Pipe
p. K68



■ **Drain Cocks**

DCR601
Internal Seal
p. K69



DC602
Internal Seal
p. K69



DC603
Internal Seal
p. K69



DC604
External Seal
p. K69



DC606
External Seal
p. K69



DC607
Bib Drain
p. K69



■ **Auxiliary**

PVMB-001
Mounting Bracket
p. K50



V502P-X-ACT
Actuator
p. K52



V502SS-X-ACT
Actuator
p. K52



V502P-X-SUB
Sub-Assembly
p. K53



V502SS-X-SUB
Sub-Assembly
p. K53



ACT-P-X-KIT
Brass Actuator Kit
p. K53



ACT-SS-X-KIT
Stainless Actuator
Kit
p. K53



STX-P
Stem Extension
p. K63



HV104C-KIT
Humidifier Valve Kit
p. K65



SPV104C-KIT
Self Piercing Kit
p. K65



WARNING These products can expose you to chemicals including NICKEL, CARBON BLACK, or LEAD, which are known to the state of California to cause cancer, and LEAD which is known to cause birth defects or other reproductive harm. For more information go to www.P65Warnings.ca.gov.

- A
- B
- C
- D
- E
- F
- G
- H
- I
- J
- K
- L
- M
- N
- O

A
B
C
D
E
F
G
H
I
J
K
L
M
N
O



Ball Valves Brass Series 500

Parker's industrial ball valves are intended for general purpose use. Ball valves are intended for use in the fully open or closed positions. Throttling of the valve may result in premature seal failure and/or inability to turn the valve handle.

Product Features:

- Forged brass body
- Chrome plated brass ball
- PTFE seats/seals
- Steel handle

Style:

- V-Valve
- VP-Valve, padlocking handle
- VV-Valve, vented
- VVP-Valve, vented, padlocking handle

Type:

- 500-Female/Female PTF ports

Material:

- P-Brass
- PN-Nickel plated

Options:

- 01-Stainless Steel Ball & Stem
- 02-Stainless Steel Handle & Nut
- 03-Stainless Steel Ball, Stem, Handle & Nut
- 04-Tee Handle
- 08-Unmarked yellow vinyl handle cover
- 21-Oval Handle

Specifications:

Pressure Range:

- 600 WOG , Cold Non-shock
- Saturated Steam up to 150 PSI (10.3 bar)
- Vacuum Service to 29 Inches Hg
- Vented up to 250 PSI (17.2 bar)

Temperature Range

- 0° to +350° F (-17.7° to +176.6° C)

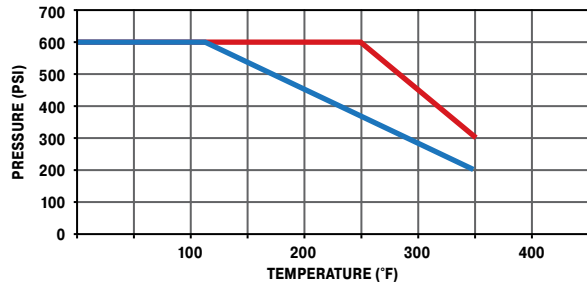

- 1/4" to 1"
- 1 1/4" to 2"

| FLOW DATA | |
|------------|-------|
| VALVE SIZE | CV |
| 1/4 | 4.0 |
| 3/8 | 5.8 |
| 1/2 | 12.0 |
| 3/4 | 25.0 |
| 1 | 35.0 |
| 1-1/4* | 57.0 |
| 1-1/2* | 92.0 |
| 2* | 224.0 |

*For these part numbers only the * options are available.

WARNING These products can expose you to chemicals including NICKEL or LEAD, which are known to the state of California to cause cancer, and LEAD which is known to cause birth defects or other reproductive harm. For more information go to www.P65Warnings.ca.gov.



Click here for CADs, Product Specifications or to Configure Parts Online

Female-Female Pipe Ends V500P

| PART NO. | PIPE THREAD [PTF] | B HEX | C HEX | H | L | M | N | FLOW DIA. D |
|----------|-------------------|--------|--------|------|------|------|------|-------------|
| V500P-4 | 1/4 | 15/16 | 15/16 | 3.96 | 4.90 | 2.03 | 2.47 | .375 |
| V500P-6 | 3/8 | 15/16 | 15/16 | 3.96 | 4.90 | 2.03 | 2.47 | .375 |
| V500P-8 | 1/2* | 1-1/16 | 1-1/16 | 3.96 | 5.00 | 2.20 | 2.58 | .500 |
| V500P-12 | 3/4** | 1-1/4 | 1-5/16 | 3.96 | 5.25 | 2.42 | 2.81 | .685 |
| V500P-16 | 1** | 1-1/2 | 1-9/16 | 3.96 | 5.34 | 2.75 | 3.08 | .875 |

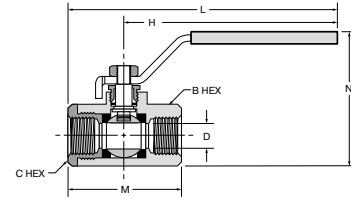

Female-Female Pipe Ends V500P-20, V500P-24, V500P-32

| PART NO. | PIPE THREAD [NPT] | OCTAGON | H | L | M | N | FLOW DIA. D |
|----------|-------------------|---------|------|------|------|------|-------------|
| V500P-20 | 1-1/4 | 1.93 | 6.22 | 8.05 | 3.66 | 3.01 | 1.18 |
| V500P-24 | 1-1/2 | 2.13 | 6.22 | 8.23 | 4.02 | 3.25 | 1.50 |
| V500P-32 | 2 | 2.69 | 6.22 | 8.58 | 4.76 | 3.52 | 1.89 |

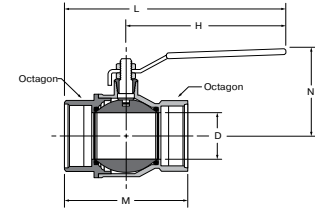

Vented, Female Pipe Ends VV500P

| PART NO. | PIPE THREAD [PTF] | B HEX | C HEX | K | H | L | M | N | D FLOW Ø |
|-----------|-------------------|--------|--------|------|------|------|------|------|----------|
| VV500P-4 | 1/4 | 15/16 | 15/16 | 1.11 | 3.96 | 4.90 | 2.03 | 2.47 | .375 |
| VV500P-6 | 3/8 | 15/16 | 15/16 | 1.11 | 3.96 | 4.90 | 2.03 | 2.47 | .375 |
| VV500P-8 | 1/2* | 1-1/16 | 1-1/16 | 1.23 | 3.96 | 5.00 | 2.20 | 2.58 | .500 |
| VV500P-12 | 3/4** | 1-1/4 | 1-5/16 | 1.45 | 3.96 | 5.25 | 2.42 | 2.81 | .685 |
| VV500P-16 | 1** | 1-1/2 | 1-9/16 | 1.58 | 3.96 | 5.34 | 2.75 | 3.08 | .875 |

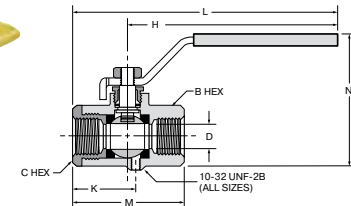

Locking Handle, Female Pipe Ends VP500P

| PART NO. | PIPE THREAD [PTF] | B HEX | C HEX | H | L | M | N | D FLOW Ø |
|---------------------------------------|-------------------|---------|---------|------|------|------|------|----------|
| VP500P-4 | 1/4 | 15/16 | 15/16 | 3.96 | 4.90 | 2.03 | 2.47 | .375 |
| VP500P-6 | 3/8 | 15/16 | 15/16 | 3.96 | 4.90 | 2.03 | 2.47 | .375 |
| VP500P-8 | 1/2* | 1-1/16 | 1-1/16 | 3.96 | 5.00 | 2.20 | 2.58 | .500 |
| VP500P-12 | 3/4** | 1-1/4 | 1-5/16 | 3.96 | 5.25 | 2.42 | 2.81 | .685 |
| VP500P-16 | 1** | 1-1/2 | 1-9/16 | 3.96 | 5.34 | 2.75 | 3.08 | .875 |
| FOR USE WITH 5/16" Ø SHANK LOCK; .33Ø | | | | | | | | |
| VP500P-20 | 1-1/4 | 1-15/16 | 1-15/16 | 6.22 | 8.05 | 3.66 | 4.04 | 1.180 |
| VP500P-24 | 1-1/2 | 2-1/8 | 2-1/8 | 6.22 | 8.23 | 4.02 | 4.52 | 1.500 |
| VP500P-32 | 2 | 2-11/16 | 2-11/16 | 6.22 | 8.60 | 4.76 | 5.07 | 1.890 |
| FOR USE WITH 9/32" Ø SHANK LOCK; .31Ø | | | | | | | | |

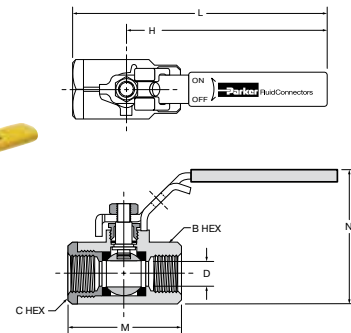

OSHA 29 CFR Part 1910 Vented, Locking Handle, Female Pipe Ends VVP500P

| PART NO. | PIPE THD [PTF] | B HEX | C HEX | K | H | L | M | N | D FLOW Ø |
|---------------------------------|----------------|--------|--------|------|------|------|------|------|----------|
| VVP500P-4 | 1/4 | 15/16 | 15/16 | 1.11 | 3.96 | 4.90 | 2.03 | 2.47 | .375 |
| VVP500P-6 | 3/8 | 15/16 | 15/16 | 1.11 | 3.96 | 4.90 | 2.03 | 2.47 | .375 |
| VVP500P-8 | 1/2* | 1-1/16 | 1-1/16 | 1.23 | 3.96 | 5.00 | 2.20 | 2.58 | .500 |
| VVP500P-12 | 3/4** | 1-1/4 | 1-5/16 | 1.45 | 3.96 | 5.25 | 2.42 | 2.81 | .685 |
| VVP500P-16 | 1** | 1-1/2 | 1-9/16 | 1.58 | 3.96 | 5.34 | 2.75 | 3.08 | .875 |
| FOR USE WITH 5/16" Ø SHANK LOCK | | | | | | | | | |

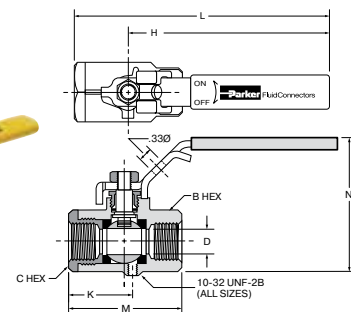

*PTF Special Short. **PTF SPL Extra Short

WARNING These products can expose you to chemicals including NICKEL or LEAD, which are known to the state of California to cause cancer, and LEAD which is known to cause birth defects or other reproductive harm. For more information go to www.P65Warnings.ca.gov.



- A
- B
- C
- D
- E
- F
- G
- H
- I
- J
- K
- L
- M
- N
- O

Click here for CADs, Product Specifications or to Configure Parts Online

Tee Handle, Female Pipe Ends V500P-X-04

| PART NO. | PIPE THREAD [PTF] | B HEX | C HEX | H | L | M | N | D FLOW Ø |
|-------------|-------------------|--------|--------|------|------|------|------|----------|
| V500P-4-04 | 1/4 | 15/16 | 15/16 | 1.25 | 2.50 | 2.03 | 1.87 | .375 |
| V500P-6-04 | 3/8 | 15/16 | 15/16 | 1.25 | 2.50 | 2.03 | 1.87 | .375 |
| V500P-8-04 | 1/2* | 1-1/16 | 1-1/16 | 1.25 | 2.50 | 2.20 | 1.98 | .500 |
| V500P-12-04 | 3/4** | 1-1/4 | 1-5/16 | 1.25 | 2.50 | 2.42 | 2.20 | .685 |
| V500P-16-04 | 1** | 1-1/2 | 1-9/16 | 1.25 | 2.50 | 2.75 | 2.48 | .875 |

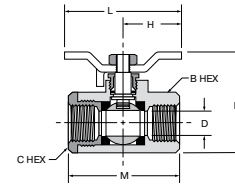

Oval Handle, Female Pipe Ends V500P-X-21

| PART NO. | PIPE THREAD [PTF] | B HEX | C HEX | H | L | M | N | D FLOW Ø |
|-------------|-------------------|--------|--------|------|------|------|------|----------|
| V500P-4-21 | 1/4 | 15/16 | 15/16 | 1.74 | 3.49 | 2.03 | 2.38 | .375 |
| V500P-6-21 | 3/8 | 15/16 | 15/16 | 1.74 | 3.49 | 2.03 | 2.38 | .375 |
| V500P-8-21 | 1/2* | 1-1/16 | 1-1/16 | 1.74 | 3.49 | 2.20 | 2.49 | .500 |
| V500P-12-21 | 3/4** | 1-1/4 | 1-5/16 | 1.74 | 3.48 | 2.42 | 2.71 | .685 |
| V500P-16-21 | 1** | 1-1/2 | 1-9/16 | 1.74 | 3.48 | 2.75 | 2.99 | .875 |

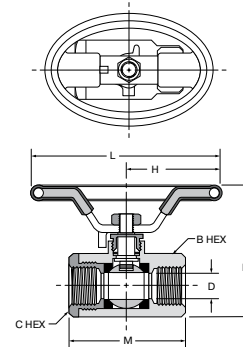

*PTF Special Short. **PTF SPL Extra Short

WARNING These products can expose you to chemicals including NICKEL or LEAD, which are known to the state of California to cause cancer, and LEAD which is known to cause birth defects or other reproductive harm. For more information go to www.P65Warnings.ca.gov.



Ball Valves Brass Series 501



Product Features:

- Forged brass body
- Chrome plated brass ball
- PTFE seats/seals
- Steel handle

Style:

- V-Valve
- VP-Valve, padlocking handle
- VV-Valve, vented
- VVP-Valve, vented, padlocking handle

Type:

- 501-Male/Female PTF ports

Material:

- P-Brass
- PN-Nickel plated

Options:

- 01-Stainless Steel Ball & Stem
- 02-Stainless Steel Handle & Nut
- 03-Stainless Steel Ball, Stem, Handle & Nut
- 04-Tee Handle
- 08-Unmarked yellow vinyl handle cover
- 21-Oval Handle

Pressure Range:

- 600 WOG , Cold Non-shock
- Saturated Steam up to 150 PSI (10.3 bar)
- Vacuum Service to 29 Inches Hg
- Vented up to 250 PSI (17.2 bar)
- XV501PCHP up to 2000PSI (137.8 bar)

Temperature Range

- 0° to +350° F (-17.7° to +176.6° C)

Flow Data

| VALVE SIZE | CV | VALVE SIZE | CV |
|------------|------|------------|------|
| 1/4 | 6.3 | 3/4 | 25.0 |
| 3/8 | 5.7 | 1 | 35.0 |
| 1/2 | 10.0 | | |

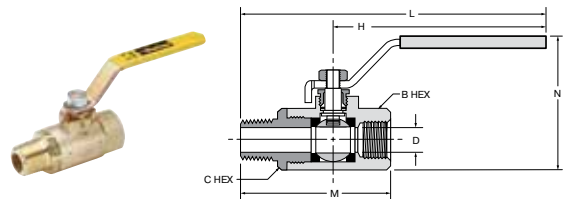
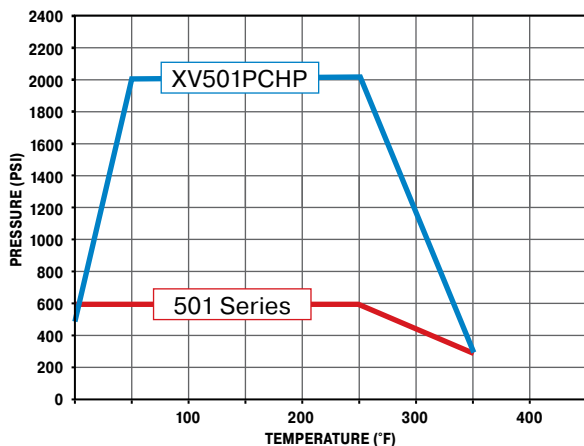

Male-Female Pipe Ends V501P

| PART NO. | FEMALE PIPE THRD [PTF] | MALE PIPE THRD [NPTF] | B HEX | C HEX | H | L | M | N | D FLOW Ø |
|----------|------------------------|-----------------------|--------|--------|------|------|------|------|----------|
| V501P-4 | 1/4 | 1/4 | 15/16 | 15/16 | 3.96 | 5.46 | 2.59 | 2.47 | .344 |
| V501P-6 | 3/8 | 3/8 | 15/16 | 15/16 | 3.96 | 5.46 | 2.59 | 2.47 | .375 |
| V501P-8 | 1/2* | 1/2 | 1-1/16 | 1-1/16 | 3.96 | 5.75 | 2.94 | 2.58 | .500 |
| V501P-12 | 3/4** | 3/4* | 1-1/4 | 1-5/16 | 3.96 | 5.83 | 3.00 | 2.81 | .685 |
| V501P-16 | 1** | 1* | 1-1/2 | 1-9/16 | 3.96 | 6.19 | 3.60 | 3.08 | .875 |

*PTF Special Short. **PTF SPL Extra Short

WARNING These products can expose you to chemicals including NICKEL or LEAD, which are known to the state of California to cause cancer, and LEAD which is known to cause birth defects or other reproductive harm. For more information go to www.P65Warnings.ca.gov.



Click here for CADs, Product Specifications or to Configure Parts Online

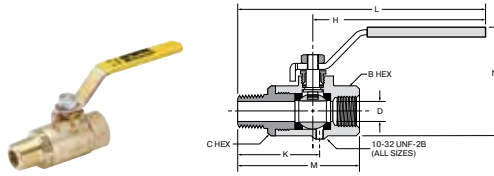

Vented, Male-Female Pipe Ends VV501P

| PART NO. | FEMALE PIPE THRD [PTF] | MALE PIPE THRD [NPTF] | B HEX | C HEX | K | H | L | M | N | D FLOW Ø |
|-----------|------------------------|-----------------------|--------|--------|------|------|------|------|------|----------|
| VV501P-4 | 1/4 | 1/4 | 15/16 | 15/16 | 1.67 | 3.96 | 5.46 | 2.59 | 2.47 | .344 |
| VV501P-6 | 3/8 | 3/8 | 15/16 | 15/16 | 1.67 | 3.96 | 5.46 | 2.59 | 2.47 | .375 |
| VV501P-8 | 1/2* | 1/2 | 1-1/16 | 1-1/16 | 1.98 | 3.96 | 5.75 | 2.95 | 2.58 | .500 |
| VV501P-12 | 3/4** | 3/4* | 1-1/4 | 1-5/16 | 2.03 | 3.96 | 5.83 | 3.00 | 2.81 | .685 |
| VV501P-16 | 1** | 1* | 1-1/2 | 1-9/16 | 2.43 | 3.96 | 6.19 | 3.60 | 3.08 | .875 |

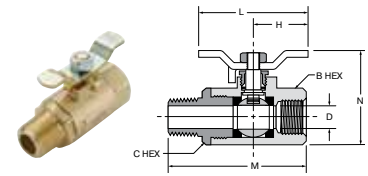

Tee Handle, Male-Female Pipe Ends V501P-X-04

| PART NO. | FEMALE PIPE THRD [PTF] | MALE PIPE THRD [NPTF] | B HEX | C HEX | H | L | M | N | D FLOW Ø |
|-------------|------------------------|-----------------------|--------|--------|------|------|------|------|----------|
| V501P-4-04 | 1/4 | 1/4 | 15/16 | 15/16 | 1.25 | 2.50 | 2.59 | 1.87 | .344 |
| V501P-6-04 | 3/8 | 3/8 | 15/16 | 15/16 | 1.25 | 2.50 | 2.59 | 1.87 | .375 |
| V501P-8-04 | 1/2* | 1/2 | 1-1/16 | 1-1/16 | 1.25 | 2.50 | 2.95 | 1.98 | .500 |
| V501P-12-04 | 3/4** | 3/4 | 1-1/4 | 1-5/16 | 1.25 | 2.50 | 3.00 | 2.20 | .685 |
| V501P-16-04 | 1** | 1 | 1-1/2 | 1-9/16 | 1.25 | 2.50 | 3.60 | 2.48 | .875 |

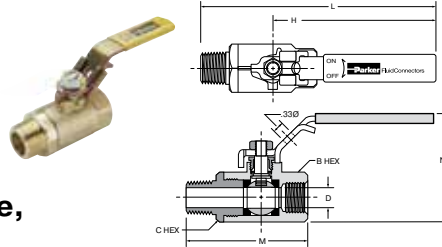

Locking Handle, Male-Female Pipe Ends VP501P

| PART NO. | FEMALE PIPE THRD [PTF] | MALE PIPE THRD [NPTF] | B HEX | C HEX | H | L | M | N | D FLOW Ø |
|-----------|------------------------|-----------------------|--------|--------|------|------|------|------|----------|
| VP501P-4 | 1/4 | 1/4 | 15/16 | 15/16 | 3.96 | 5.46 | 2.59 | 2.47 | .344 |
| VP501P-6 | 3/8 | 3/8 | 15/16 | 15/16 | 3.96 | 5.46 | 2.59 | 2.47 | .375 |
| VP501P-8 | 1/2* | 1/2 | 1-1/16 | 1-1/16 | 3.96 | 5.75 | 2.95 | 2.58 | .500 |
| VP501P-12 | 3/4** | 3/4* | 1-1/4 | 1-5/16 | 3.96 | 5.83 | 3.00 | 2.81 | .685 |
| VP501P-16 | 1** | 1* | 1-1/2 | 1-9/16 | 3.96 | 6.19 | 3.60 | 3.08 | .875 |

For use with 5/16" Ø shank lock

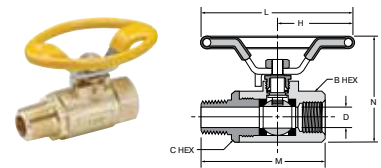

Oval Handle, Male-Female Pipe Ends V501P-X-21

| PART NO. | FEMALE PIPE THRD [PTF] | MALE PIPE THRD [NPTF] | B HEX | C HEX | H | L | M | N | D FLOW Ø |
|-------------|------------------------|-----------------------|--------|--------|------|------|------|------|----------|
| V501P-4-21 | 1/4 | 1/4 | 15/16 | 15/16 | 1.74 | 3.49 | 2.59 | 2.38 | .344 |
| V501P-6-21 | 3/8 | 3/8 | 15/16 | 15/16 | 1.74 | 3.49 | 2.59 | 2.38 | .375 |
| V501P-8-21 | 1/2* | 1/2 | 1-1/16 | 1-1/16 | 1.74 | 3.49 | 2.95 | 2.49 | .500 |
| V501P-12-21 | 3/4** | 3/4 | 1-1/4 | 1-5/16 | 1.74 | 3.48 | 3.00 | 2.71 | .685 |
| V501P-16-21 | 1** | 1 | 1-1/2 | 1-9/16 | 1.74 | 3.48 | 3.60 | 2.99 | .875 |

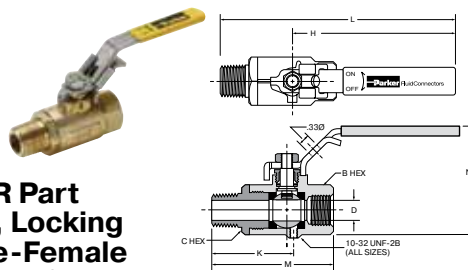

OSHA 29 CFR Part 1910 Vented, Locking Handle, Male-Female Pipe Ends VVP501P

| PART NO. | FEMALE PIPE THRD [PTF] | MALE PIPE THRD [NPTF] | B HEX | C HEX | K | H | L | M | N | D FLOW Ø |
|------------|------------------------|-----------------------|--------|--------|------|------|------|------|------|----------|
| VVP501P-4 | 1/4 | 1/4 | 15/16 | 15/16 | 1.67 | 3.96 | 5.46 | 2.59 | 2.47 | .344 |
| VVP501P-6 | 3/8 | 3/8 | 15/16 | 15/16 | 1.67 | 3.96 | 5.46 | 2.59 | 2.47 | .375 |
| VVP501P-8 | 1/2* | 1/2 | 1-1/16 | 1-1/16 | 1.98 | 3.96 | 5.75 | 2.95 | 2.58 | .500 |
| VVP501P-12 | 3/4** | 3/4 | 1-1/4 | 1-5/16 | 2.03 | 3.96 | 5.83 | 3.00 | 2.81 | .685 |
| VVP501P-16 | 1** | 1 | 1-1/2 | 1-9/16 | 2.43 | 3.96 | 6.19 | 3.60 | 3.08 | .875 |

For use with 5/16" Ø shank lock

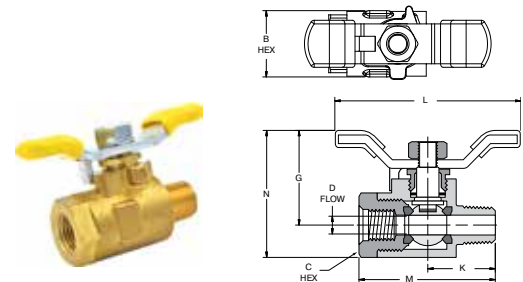

Compact High Pressure XV501PCHP

| PART NO. | FEMALE PIPE THRD [PTF] | MALE PIPE THRD [NPTF] | B HEX | C HEX | G | K | L | M | N | D FLOW Ø |
|-------------|------------------------|-----------------------|-------|-------|------|-----|------|------|------|----------|
| XV501PCHP-4 | 1/4 | 1/4 | 15/16 | 13/16 | 1.33 | .95 | 2.62 | 1.92 | 1.79 | .25 |

*PTF Special Short. **PTF SPL Extra Short

WARNING These products can expose you to chemicals including NICKEL or LEAD, which are known to the state of California to cause cancer, and LEAD which is known to cause birth defects or other reproductive harm. For more information go to www.P65Warnings.ca.gov.



Ball Valves Brass Series 502



Product Features:

- Forged brass body
- Chrome plated brass ball
- PTFE seats/seals
- Steel handle

Style:

- V-Valve
- VP-Valve, padlocking handle
- VV-Valve, vented
- VVP-Valve, vented, padlocking handle

Type:

- 502-Female/Female PTF ports

Material:

- P-Brass
- PN-Nickel plated

Options:

- 01-Stainless Steel Ball & Stem
- 02-Stainless Steel Handle & Nut
- 03-Stainless Steel Ball, Stem, Handle & Nut
- 04-Tee Handle
- 08-Unmarked yellow vinyl handle cover
- 21-Oval Handle

Specifications:

Pressure Range:

- 600 WOG , Cold Non-shock
- Saturated Steam up to 150 PSI (10.3 bar)
- Vacuum Service to 29 Inches Hg
- Vented up to 250 PSI (17.2 bar)

Temperature Range

- 0° to +350° F (-17.7° to +176.6° C)

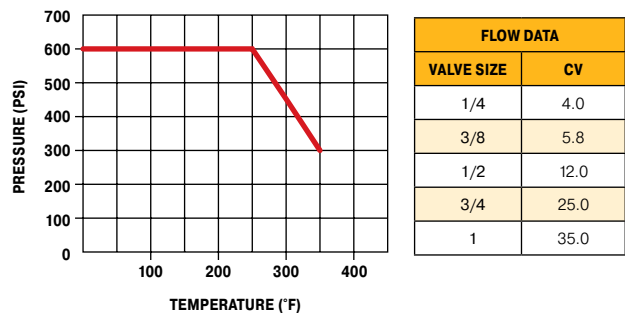

Mounting detail for all sizes

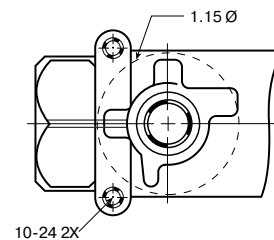

WARNING These products can expose you to chemicals including NICKEL or LEAD, which are known to the state of California to cause cancer, and LEAD which is known to cause birth defects or other reproductive harm. For more information go to www.P65Warnings.ca.gov.



A

B

C

D

E

F

G

H

I

J

K

L

M

N

O

Click here for CADs, Product Specifications or to Configure Parts Online

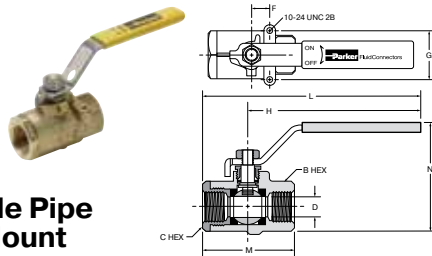

Female-Female Pipe Ends, Panel Mount V502P

| PART NO. | PIPE THD. [PTF] | B HEX | C HEX | F | G | H | L | M | N | FLOW DIA. D |
|----------|-----------------|--------|--------|-----|------|------|------|------|------|-------------|
| V502P-4 | 1/4 | 15/16 | 15/16 | .50 | 1.12 | 3.96 | 4.90 | 2.03 | 2.47 | .375 |
| V502P-6 | 3/8 | 15/16 | 15/16 | .50 | 1.12 | 3.96 | 4.90 | 2.03 | 2.47 | .375 |
| V502P-8 | 1/2* | 1-1/16 | 1-1/16 | .50 | 1.12 | 3.96 | 5.06 | 2.20 | 2.58 | .500 |
| V502P-12 | 3/4** | 1-1/4 | 1-5/16 | .87 | 1.37 | 3.96 | 5.25 | 2.42 | 2.81 | .685 |
| V502P-16 | 1** | 1-1/2 | 1-9/16 | .87 | 1.37 | 3.96 | 5.34 | 2.75 | 3.08 | .875 |

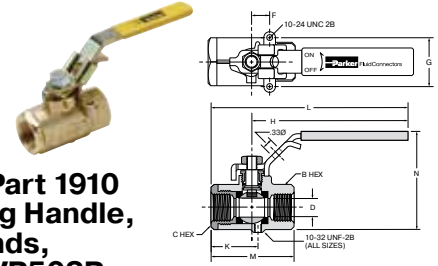

OSHA 29 CFR Part 1910 Vented, Locking Handle, Female Pipe Ends, Panel Mount VVP502P

| PART NO. | PIPE THD. [PTF] | B HEX | C HEX | F | G | K | H | L | M | N | D FLOW Ø |
|------------|-----------------|--------|--------|-----|------|------|------|------|------|------|----------|
| VVP502P-4 | 1/4 | 15/16 | 15/16 | .50 | 1.12 | 1.11 | 3.96 | 4.90 | 2.03 | 2.47 | .375 |
| VVP502P-6 | 3/8 | 15/16 | 15/16 | .50 | 1.12 | 1.11 | 3.96 | 4.90 | 2.03 | 2.47 | .375 |
| VVP502P-8 | 1/2* | 1-1/16 | 1-1/16 | .50 | 1.12 | 1.23 | 3.96 | 5.06 | 2.20 | 2.58 | .500 |
| VVP502P-12 | 3/4** | 1-1/4 | 1-5/16 | .87 | 1.37 | 1.45 | 3.96 | 5.25 | 2.42 | 2.81 | .685 |
| VVP502P-16 | 1** | 1-1/2 | 1-9/16 | .87 | 1.37 | 1.58 | 3.96 | 5.34 | 2.75 | 3.08 | .875 |

For use with 5/16" Ø shank lock

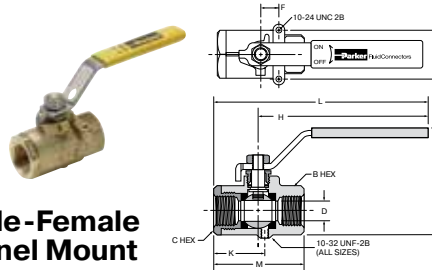

Vented, Female-Female Pipe Ends, Panel Mount WV502P

| PART NO. | PIPE THD. [PTF] | B HEX | C HEX | F | G | K | H | L | M | N | D FLOW Ø |
|-----------|-----------------|--------|--------|-----|------|------|------|------|------|------|----------|
| WV502P-4 | 1/4 | 15/16 | 15/16 | .50 | 1.12 | 1.11 | 3.96 | 4.90 | 2.03 | 2.47 | .375 |
| WV502P-6 | 3/8 | 15/16 | 15/16 | .50 | 1.12 | 1.11 | 3.96 | 4.90 | 2.03 | 2.47 | .375 |
| WV502P-8 | 1/2* | 1-1/16 | 1-1/16 | .50 | 1.12 | 1.23 | 3.96 | 5.06 | 2.20 | 2.58 | .500 |
| WV502P-12 | 3/4** | 1-1/4 | 1-5/16 | .87 | 1.37 | 1.45 | 3.96 | 5.25 | 2.42 | 2.81 | .685 |
| WV502P-16 | 1** | 1-1/2 | 1-9/16 | .87 | 1.37 | 1.58 | 3.96 | 5.34 | 2.75 | 3.08 | .875 |

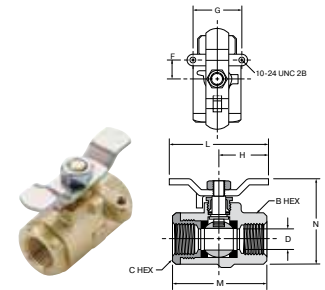

Tee Handle, Female Pipe Ends, Panel Mount V502P-X-04

| PART NO. | PIPE THD. [PTF] | B HEX | C HEX | F | G | H | L | M | N | D FLOW Ø |
|-------------|-----------------|--------|--------|-----|------|------|------|------|------|----------|
| V502P-4-04 | 1/4 | 15/16 | 15/16 | .50 | 1.12 | 1.25 | 2.50 | 2.03 | 1.87 | .375 |
| V502P-6-04 | 3/8 | 15/16 | 15/16 | .50 | 1.12 | 1.25 | 2.50 | 2.03 | 1.87 | .375 |
| V502P-8-04 | 1/2* | 1-1/16 | 1-1/16 | .50 | 1.12 | 1.25 | 2.50 | 2.20 | 1.98 | .500 |
| V502P-12-04 | 3/4** | 1-1/4 | 1-5/16 | .87 | 1.37 | 1.25 | 2.50 | 2.42 | 2.20 | .685 |
| V502P-16-04 | 1** | 1-1/2 | 1-9/16 | .87 | 1.37 | 1.25 | 2.50 | 2.75 | 2.48 | .875 |

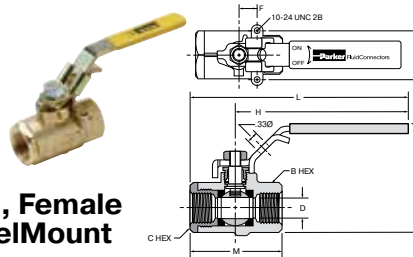

Locking Handle, Female Pipe Ends, Panel Mount VP502P

| PART NO. | PIPE THD. [PTF] | B HEX | C HEX | F | G | H | L | M | N | D FLOW Ø |
|-----------|-----------------|--------|--------|-----|------|------|------|------|------|----------|
| VP502P-4 | 1/4 | 15/16 | 15/16 | .50 | 1.12 | 3.96 | 4.90 | 2.03 | 2.47 | .375 |
| VP502P-6 | 3/8 | 15/16 | 15/16 | .50 | 1.12 | 3.96 | 4.90 | 2.03 | 2.47 | .375 |
| VP502P-8 | 1/2* | 1-1/16 | 1-1/16 | .50 | 1.12 | 3.96 | 5.06 | 2.20 | 2.58 | .500 |
| VP502P-12 | 3/4** | 1-1/4 | 1-5/16 | .87 | 1.37 | 3.96 | 5.25 | 2.42 | 2.81 | .685 |
| VP502P-16 | 1** | 1-1/2 | 1-9/16 | .87 | 1.37 | 3.96 | 5.34 | 2.75 | 3.08 | .875 |

For use with 5/16" Ø shank lock

*PTF Special Short. **PTF SPL Extra Short

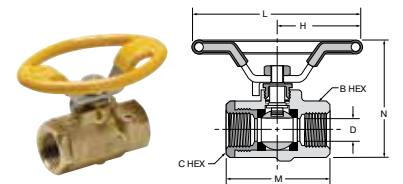

Oval Handle, Female Pipe Ends, Panel Mount V502P-X-21

| PART NO. | PIPE THD. [PTF] | B HEX | C HEX | H | L | M | N | D FLOW Ø |
|-------------|-----------------|--------|--------|------|------|------|------|----------|
| V502P-4-21 | 1/4 | 15/16 | 15/16 | 1.74 | 3.49 | 2.03 | 2.38 | .375 |
| V502P-6-21 | 3/8 | 15/16 | 15/16 | 1.74 | 3.49 | 2.03 | 2.38 | .375 |
| V502P-8-21 | 1/2* | 1-1/16 | 1-1/16 | 1.74 | 3.49 | 2.20 | 2.49 | .500 |
| V502P-12-21 | 3/4** | 1-1/4 | 1-5/16 | 1.74 | 3.48 | 2.42 | 2.71 | .685 |
| V502P-16-21 | 1** | 1-1/2 | 1-9/16 | 1.74 | 3.48 | 2.75 | 2.99 | .875 |

WARNING These products can expose you to chemicals including NICKEL or LEAD, which are known to the state of California to cause cancer, and LEAD which is known to cause birth defects or other reproductive harm. For more information go to www.P65Warnings.ca.gov.



Ball Valve Brass Series 506



Product Features:

- Forged brass body
- Chrome plated brass ball
- PTFE seats/seals
- Steel handle

Style:

- V-Valve
- VP-Valve, padlocking handle

Type:

- 506-Female/Female SAE J1926-1 Ports

Material:

- P-Brass
- PN-Nickel plated

Options:

- 01-Stainless Steel Ball & Stem
- 02-Stainless Steel Handle & Nut
- 03-Stainless Steel Ball, Stem, Handle & Nut
- 04-Tee Handle
- 08-Unmarked yellow vinyl handle cover
- 21-Oval Handle

Specifications:

Pressure Range:

- 600 WOG , Cold Non-shock
- Saturated Steam up to 150 PSI (10.3 bar)
- Vacuum Service to 29 Inches Hg

Temperature Range

- 0° to +350° F (-17.7° to +176.6° C)

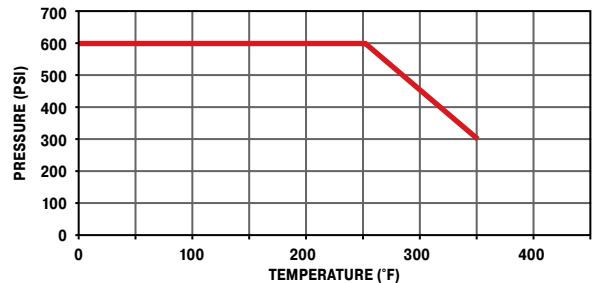

WARNING These products can expose you to chemicals including NICKEL or LEAD, which are known to the state of California to cause cancer, and LEAD which is known to cause birth defects or other reproductive harm. For more information go to www.P65Warnings.ca.gov.



A

B

C

D

E

F

G

H

I

J

K

L

M

N

O

[Click here for CADs, Product Specifications or to Configure Parts Online](#)

Female/Female, Straight Thread O-Ring Port V506P

| PART NO. | STRT. THREAD | B HEX | C HEX | H | L | M | N | D FLOW Ø |
|----------|--------------|--------|--------|------|------|------|------|----------|
| V506P-4 | 7/16-20 | 15/16 | 15/16 | 3.96 | 5.01 | 2.20 | 2.47 | .375 |
| V506P-6 | 9/16-18 | 15/16 | 15/16 | 3.96 | 5.07 | 2.26 | 2.47 | .375 |
| V506P-8 | 3/4-16 | 1-1/16 | 1-1/16 | 3.96 | 5.18 | 2.42 | 2.60 | .500 |
| V506P-12 | 1-1/16-12 | 1-1/4 | 1-5/16 | 3.96 | 5.87 | 3.46 | 2.81 | .685 |
| V506P-16 | 1-5/16-12 | 1-1/2 | 1-9/16 | 3.96 | 5.96 | 3.68 | 3.08 | .875 |

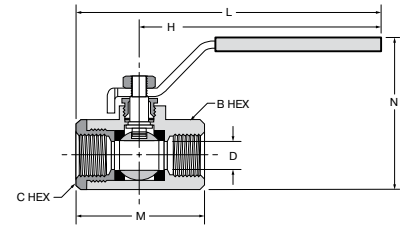

Female/Female, Straight Thread O-Ring Port V506P-20, V506P-24, V506P-32

| PART NO. | STRT. THREAD | B OCT | C OCT | H | L | M | N | D FLOW Ø |
|----------|--------------|-------|-------|------|------|------|------|----------|
| V506P-20 | 1 5/8-12 | 1.93 | 1.93 | 6.22 | 8.05 | 3.66 | 3.01 | 1.18 |
| V506P-24 | 1 7/8-12 | 2.13 | 2.13 | 6.22 | 8.23 | 4.02 | 3.25 | 1.50 |
| V506P-32 | 2 1/2-12 | 2.85 | 2.85 | 6.22 | 8.60 | 4.76 | 3.52 | 1.89 |

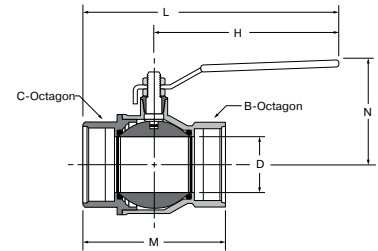

WARNING These products can expose you to chemicals including NICKEL or LEAD, which are known to the state of California to cause cancer, and LEAD which is known to cause birth defects or other reproductive harm. For more information go to www.P65Warnings.ca.gov.



Ball Valves Brass Series 509



Product Features:

- Forged brass body
- Chrome plated brass ball
- PTFE seats/seals
- Steel handle

Style:

- V-Valve

Type:

- 509-Solder Ends

Material:

- P-Brass

Specifications:

Pressure Range:

- 600 WOG , Cold Non-shock
- Saturated Steam up to 150 PSI (10.3 bar)

Temperature Range

- Nylon: 0° to +350° F (-17.7° to +176.6° C)
- Solder temperature not to exceed 470° F (243.3° C)

Solder Cup Ends V509P

| PART NO. | TUBE SIZE | E | G | H | L | M | N | FLOW DIA. D |
|----------|-----------|-------|------|------|------|------|------|-------------|
| V509P-8 | 1/2 | .630 | .49 | 3.94 | 5.00 | 2.24 | 1.69 | .55 |
| V509P-12 | 3/4 | .877 | .75 | 4.72 | 6.10 | 2.85 | 1.97 | .75 |
| V509P-16 | 1 | 1.128 | .90 | 4.72 | 6.40 | 3.35 | 2.13 | .94 |
| V509P-20 | 1 1/4 | 1.378 | .96 | 6.22 | 8.13 | 3.82 | 3.01 | 1.18 |
| V509P-24 | 1 1/2 | 1.628 | 1.10 | 6.22 | 8.46 | 4.49 | 3.25 | 1.50 |
| V509P-32 | 2 | 2.128 | 1.34 | 6.22 | 8.94 | 5.43 | 3.52 | 1.89 |

| FLOW DATA | |
|------------|-----|
| VALVE SIZE | CV |
| 1/2" | 26 |
| 3/4" | 69 |
| 1" | 91 |
| 1 1/4" | 127 |
| 1 1/2" | 299 |
| 2" | 425 |

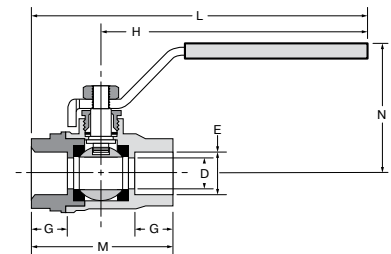

*For these part numbers only the * options are available.

A

B

C

D

E

F

G

H

I

J

K

L

M

N

O

A
B
C
D
E
F
G
H
I
J
K
L
M
N
O

Ball Valves Brass Series 510



Product Features:

- Forged brass body
- Chrome plated brass ball
- PTFE seats/seals
- Steel handle

Style:

- V-Valve
- VP-Valve, padlocking handle

Type:

- 510-Male/Female Straight Thread O-ring SAE J1926

Material:

- P-Brass

Options:

- 01-Stainless Steel Ball & Stem
- 02-Stainless Steel Handle & Nut
- 03-Stainless Steel Ball, Stem, Handle & Nut
- 04-Tee Handle
- 08-Unmarked yellow vinyl handle cover
- 21-Oval Handle

Specifications:

Pressure Range:

- 600 WOG , Cold Non-shock
- Saturated Steam up to 150 PSI (10.3 bar)
- Vacuum Service to 29 Inches Hg
- Vented up to 250 PSI (17.2 bar)

Temperature Range

- 0° to +350° F (-17.7° to +176.6° C)

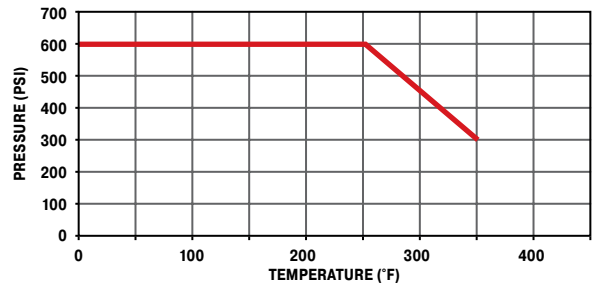

| FLOW DATA | |
|------------|------|
| VALVE SIZE | CV |
| 1/4 | .8 |
| 3/8 | 2.1 |
| 1/2 | 5.3 |
| 5/8 | 7.6 |
| 3/4 | 13.0 |
| 1 | 33.0 |

WARNING These products can expose you to chemicals including NICKEL or LEAD, which are known to the state of California to cause cancer, and LEAD which is known to cause birth defects or other reproductive harm. For more information go to www.P65Warnings.ca.gov.



Click here for CADs, Product Specifications or to Configure Parts Online

Male-Female, Straight Thread O-Ring Port V510P

| PART NO. | STRT. THREAD | B HEX | C HEX | H | L | M | N | D FLOW Ø |
|----------|--------------|--------|--------|------|------|------|------|----------|
| V510P-4 | 7/16-20 | 15/16 | 15/16 | 3.96 | 5.61 | 2.85 | 2.47 | .188 |
| V510P-6 | 9/16-18 | 15/16 | 15/16 | 3.96 | 5.68 | 2.92 | 2.47 | .281 |
| V510P-8 | 3/4-16 | 1-1/16 | 1-1/16 | 3.96 | 5.88 | 3.17 | 2.58 | .422 |
| V510P-10 | 7/8-14 | 1-1/4 | 1-5/16 | 3.96 | 6.31 | 3.90 | 2.81 | .500 |
| V510P-12 | 1-1/16-12 | 1-1/4 | 1-5/16 | 3.96 | 6.44 | 4.03 | 2.81 | .656 |
| V510P-16 | 1-5/16-12 | 1-1/2 | 1-9/16 | 3.96 | 6.56 | 4.28 | 3.08 | .875 |

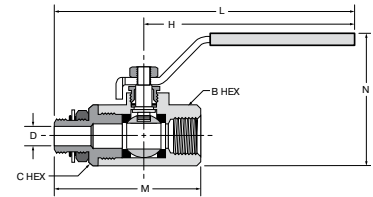

Locking Handle, Straight Thread O-Ring Port VP510P

| PART NO. | STRT. THREAD | B HEX | C HEX | H | L | M | N | D FLOW Ø |
|-----------|--------------|--------|--------|------|------|------|------|----------|
| VP510P-4 | 7/16-20 | 15/16 | 15/16 | 3.96 | 5.61 | 2.85 | 2.47 | .188 |
| VP510P-6 | 9/16-18 | 15/16 | 15/16 | 3.96 | 5.68 | 2.92 | 2.47 | .281 |
| VP510P-8 | 3/4-16 | 1-1/16 | 1-1/16 | 3.96 | 5.88 | 3.17 | 2.58 | .422 |
| VP510P-10 | 7/8-14 | 1-1/4 | 1-5/16 | 3.96 | 6.31 | 3.90 | 2.81 | .500 |
| VP510P-12 | 1-1/16-12 | 1-1/4 | 1-5/16 | 3.96 | 6.44 | 4.03 | 2.81 | .656 |

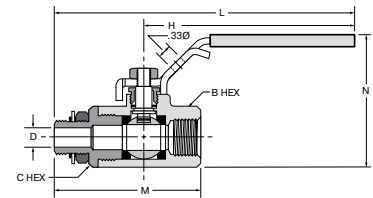

For use with 5/16" Ø shank lock

Tee Handle, Straight Thread O-Ring Port V510P-X-04

| PART NO. | STRT. THREAD | B HEX | C HEX | H | L | M | N | D FLOW Ø |
|-------------|--------------|--------|--------|------|------|------|------|----------|
| V510P-4-04 | 7/16-20 | 15/16 | 15/16 | 1.25 | 2.50 | 2.85 | 1.87 | .188 |
| V510P-6-04 | 9/16-18 | 15/16 | 15/16 | 1.25 | 2.50 | 2.92 | 1.87 | .281 |
| V510P-8-04 | 3/4-16 | 1-1/16 | 1-1/16 | 1.25 | 2.50 | 3.17 | 1.98 | .422 |
| V510P-10-04 | 7/8-14 | 1-1/4 | 1-5/16 | 1.25 | 2.50 | 3.90 | 2.20 | .500 |
| V510P-12-04 | 1-1/16-12 | 1-1/4 | 1-5/16 | 1.25 | 2.50 | 4.03 | 2.20 | .656 |
| V510P-16-04 | 1-5/16-12 | 1-1/2 | 1-9/16 | 1.25 | 2.50 | 4.28 | 2.48 | .875 |

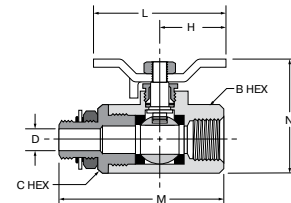

Oval Handle, Straight Thread O-Ring Port V510P-X-21

| PART NO. | STRT. THREAD | B & C HEX | H | L | M | N | D FLOW Ø |
|-------------|--------------|------------|------|------|------|------|----------|
| V510P-4-21 | 7/16-20 | 15/16 | 1.74 | 3.49 | 2.85 | 2.38 | .188 |
| V510P-6-21 | 9/16-18 | 15/16 | 1.74 | 3.49 | 2.92 | 2.38 | .281 |
| V510P-8-21 | 3/4-16 | 1 1/16 | 1.74 | 3.49 | 3.17 | 2.49 | .422 |
| V510P-12-21 | 1-1/16-12 | 1-1/4 (B) | 1.75 | 3.49 | 4.03 | 2.71 | .656 |
| | | 1-5/16 (C) | | | | | |

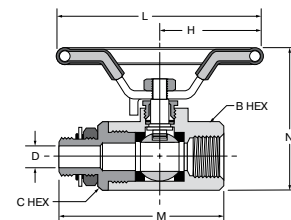

WARNING These products can expose you to chemicals including NICKEL or LEAD, which are known to the state of California to cause cancer, and LEAD which is known to cause birth defects or other reproductive harm. For more information go to www.P65Warnings.ca.gov.



- A
- B
- C
- D
- E
- F
- G
- H
- I
- J
- K
- L
- M
- N
- O

A
B
C
D
E
F
G
H
I
J
K
L
M
N
O

Ball Valves Brass Series 520



Product Features:

- Forged brass body
- Chrome plated brass ball
- PTFE seats/seals
- Fluorocarbon Stem O-rings
- Steel handle

Style:

- V-Valve
- VP-Valve, padlocking handle

Type:

- 520-Female/Female NPT Ports

Material:

- P-Brass

Options:

- 04-Tee Handle

Specifications:

Pressure Range:

- 600 WOG Cold Non-shock 1/4" – 2"
- 450 WOG, Cold Non-shock 2 1/2" – 3"
- Saturated Steam up to 150 PSI (10.3 bar)
- Vacuum Service to 29 Inches Hg

Temperature Range

- -40° to +350° F (-40° to +176.6° C)

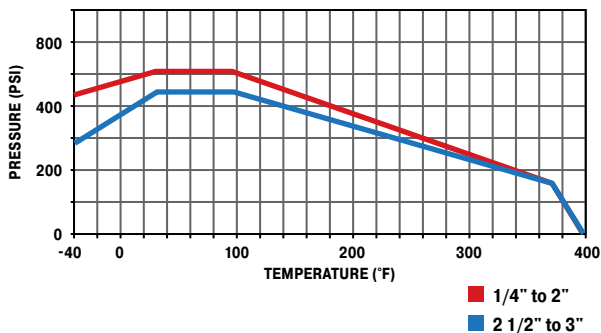

| U.L. LISTED | |
|-------------|----------------------------------|
| CATEGORY | |
| YSDT | LP-GAS SHUT-OFF VALVES |
| YRBX | FLAMMABLE LIQUID SHUT-OFF VALVES |
| YRPV | GAS SHUT-OFF VALVES |
| YQNZ | COMPRESSED GAS SHUT-OFF VALVES |

WARNING These products can expose you to chemicals including NICKEL or LEAD, which are known to the state of California to cause cancer, and LEAD which is known to cause birth defects or other reproductive harm. For more information go to www.P65Warnings.ca.gov.



[Click here for CADs, Product Specifications or to Configure Parts Online](#)

Female Pipe Ends V520P

| PART NO. | PIPE THREAD [NPT] | B OCTAGON | C OCTAGON | H | L | M | N | D FLOW Ø |
|----------|-------------------|-----------|-----------|-------|-------|------|------|----------|
| V520P-4 | 1/4-18 | .67 | .67 | 3.94 | 4.83 | 1.77 | 1.50 | .310 |
| V520P-6 | 3/8-18 | .79 | .79 | 3.94 | 4.83 | 1.77 | 1.50 | .400 |
| V520P-8 | 1/2-14 | .98 | .98 | 3.94 | 5.10 | 2.32 | 1.69 | .600 |
| V520P-12 | 3/4-14 | 1.22 | 1.22 | 4.72 | 5.98 | 2.52 | 1.97 | .790 |
| V520P-16 | 1-11.5 | 1.57 | 1.57 | 4.72 | 6.32 | 3.19 | 2.13 | 1.000 |
| V520P-20 | 1-1/4 | 1.93 | 1.93 | 6.22 | 8.05 | 3.66 | 2.82 | 1.180 |
| V520P-24 | 1-1/2 | 2.13 | 2.13 | 6.22 | 8.23 | 4.02 | 3.06 | 1.570 |
| V520P-32 | 2 | 2.69 | 2.69 | 6.22 | 8.58 | 4.76 | 3.33 | 2.000 |
| V520P-40 | 2-1/2 | 3.35 | 3.35 | 10.04 | 13.11 | 6.14 | 5.20 | 2.520 |
| V520P-48 | 3 | 3.89 | 3.89 | 10.04 | 13.52 | 6.97 | 5.51 | 3.000 |

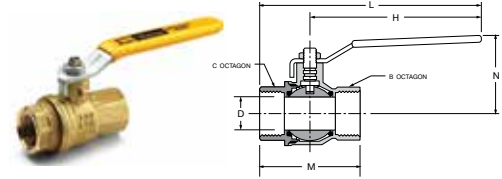

Locking Handle, Female Pipe Ends VP520P

| PART NO. | PIPE THREAD [NPT] | B OCTAGON | C OCTAGON | H | L | M | N | D FLOW Ø |
|-----------|-------------------|-----------|-----------|-------|-------|------|------|----------|
| VP520P-4 | 1/4-18 | .67 | .67 | 3.94 | 4.83 | 1.77 | 1.50 | .310 |
| VP520P-6 | 3/8-18 | .79 | .79 | 3.94 | 4.83 | 1.77 | 1.50 | .400 |
| VP520P-8 | 1/2-14 | .98 | .98 | 3.94 | 5.10 | 2.32 | 1.69 | .600 |
| VP520P-12 | 3/4-14 | 1.22 | 1.22 | 4.72 | 5.98 | 2.52 | 1.97 | .790 |
| VP520P-16 | 1-11.5 | 1.57 | 1.57 | 4.72 | 6.32 | 3.19 | 2.13 | 1.000 |
| VP520P-20 | 1-1/4 | 1.93 | 1.93 | 6.22 | 8.05 | 3.66 | 2.82 | 1.180 |
| VP520P-24 | 1-1/2 | 2.13 | 2.13 | 6.22 | 8.23 | 4.02 | 3.06 | 1.570 |
| VP520P-32 | 2 | 2.69 | 2.69 | 6.22 | 8.58 | 4.76 | 3.33 | 2.000 |
| VP520P-40 | 2-1/2 | 3.35 | 3.35 | 10.04 | 13.11 | 6.14 | 5.20 | 2.520 |
| VP520P-48 | 3 | 3.89 | 3.89 | 10.04 | 13.52 | 6.97 | 5.51 | 3.000 |

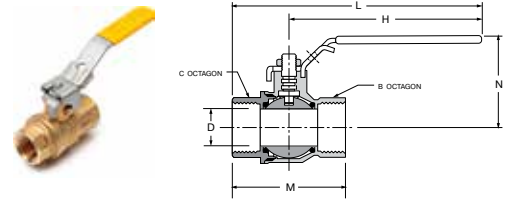

WARNING These products can expose you to chemicals including NICKEL or LEAD, which are known to the state of California to cause cancer, and LEAD which is known to cause birth defects or other reproductive harm. For more information go to www.P65Warnings.ca.gov.



- A
- B
- C
- D
- E
- F
- G
- H
- I
- J
- K
- L
- M
- N
- O

A

B

C

D

Ball Valves Brass Series 525



Parker's industrial ball valves are intended for general purpose use. Ball valves are intended for use in the fully open or closed positions. Throttling of the valve may result in premature seal failure and/or inability to turn the valve handle.

Product Features:

- Forged brass body
- Chrome plated brass ball
- PTFE seats/seals
- Steel handle
- Standard Port
- Female/Female NPT Ports

Specifications:

Pressure Range:

- 600 WOG Cold Non-shock 1/2" – 2"
- Vacuum Service to 29 Inches Hg

Temperature Range

- -40° to +350° F (-40° to +176.6° C)

G

H

I

J

Flow Coefficient

| VALUE SIZE | 1/2" | 3/4" | 1" | 1-1/4" | 1-1/2" | 2" |
|------------|------|------|----|--------|--------|----|
| CV | 8.4 | 16 | 22 | 38 | 52 | 78 |

Female Pipe Ends, V525P

| PART NO. | D | DN | I | L | G | A | H | CH |
|----------|--------|-------|-------|-------|-------|------|------|-------|
| V525P-8 | 1/2" | .453 | .610 | 2.126 | 1.043 | 3.89 | 1.62 | .984 |
| V525P-12 | 3/4" | .590 | .669 | 2.441 | 1.220 | 3.89 | 1.69 | 1.220 |
| V525P-16 | 1" | .748 | .827 | 2.835 | 1.417 | 4.72 | 1.98 | 1.496 |
| V525P-20 | 1 1/4" | .945 | .905 | 3.464 | 1.732 | 4.72 | 2.15 | 1.929 |
| V525P-24 | 1 1/2" | 1.181 | .905 | 3.779 | 1.890 | 6.23 | 2.97 | 2.126 |
| V525P-32 | 2" | 1.496 | 1.043 | 4.409 | 2.205 | 6.23 | 3.24 | 2.677 |

Note: For larger sizes, please contact the division. Packing nut may need to be tightened depending on application temperature. Periodically check the packing nut and tighten as required

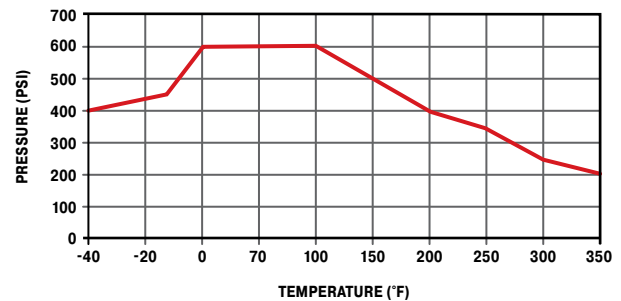

K

L

M

N

O

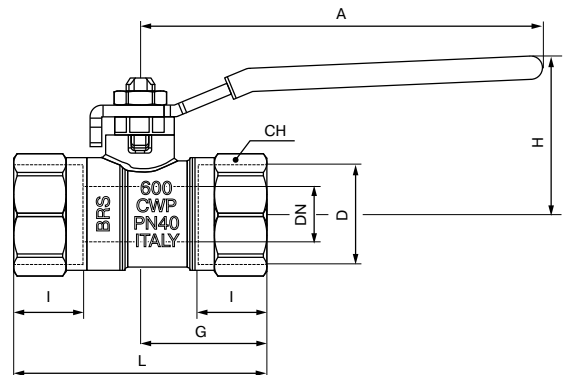

WARNING These products can expose you to chemicals including NICKEL or LEAD, which are known to the state of California to cause cancer, and LEAD which is known to cause birth defects or other reproductive harm. For more information go to www.P65Warnings.ca.gov.





Ball Valves Brass Series 533 3-Way Diversion / Series 540 4-Way

Product Features:

- Forged brass body
- Chrome plated brass ball
- PTFE seats/seals
- Steel handle

Style:

- V-Valve
- VP-Valve, padlocking handle

Type:

- 533 3-Way Diversion
- 540 4-Way

Material:

- P-Brass

Options:

- 02-Stainless Steel Handle & Nut
- 08-Unmarked yellow vinyl handle cover

Specifications:

Pressure Range:

- 400 PSI (27.5 bar)
- Vacuum Service to 29 Inches Hg

Temperature Range

- -20° to +350° F (-6.6° to +176.6° C)

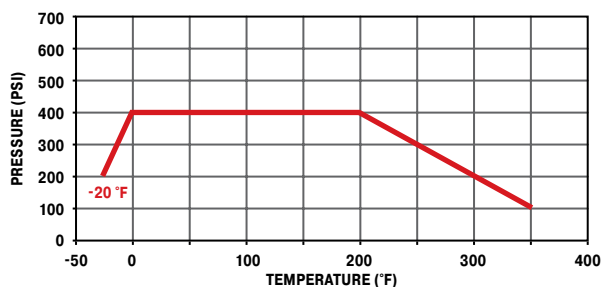

| V540P FLOW INFORMATION | |
|------------------------|-----------|
| POINTER OVER | FLOW PATH |
| A | A TO E |
| OFF | CLOSED |
| C | C TO E |
| D | D TO E |

V540P Handle Positions

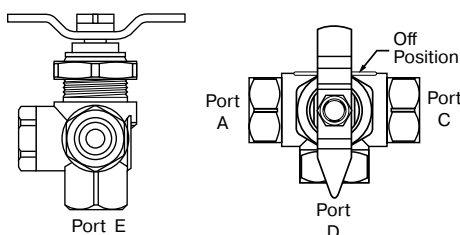

V533P Handle Positions

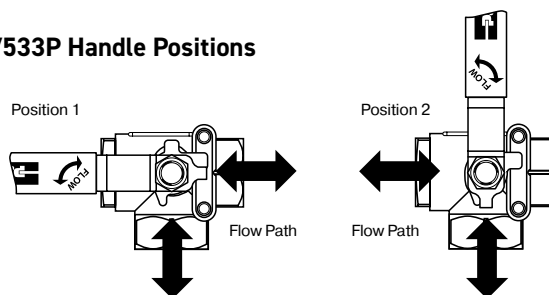

WARNING These products can expose you to chemicals including NICKEL or LEAD, which are known to the state of California to cause cancer, and LEAD which is known to cause birth defects or other reproductive harm. For more information go to www.P65Warnings.ca.gov.



Click here for CADs, Product Specifications or to Configure Parts Online

Female-Female-Female Pipe Ends V533P

| PART NO. | PIPE THD (PTF) | B HEX | E | F | G | H | K | L | M | N | FLOW DIA. D |
|----------|----------------|--------|-----|------|------|------|------|------|------|------|-------------|
| V533P-4 | 1/4 | 15/16 | .50 | 1.08 | 1.12 | 3.96 | 1.03 | 2.47 | 2.03 | 1.94 | .375 |
| V533P-6 | 3/8 | 15/16 | .50 | 1.08 | 1.12 | 3.96 | 1.03 | 2.47 | 2.03 | 1.94 | .375 |
| V533P-8 | 1/2 | 1-1/16 | .50 | 1.18 | 1.12 | 3.96 | 1.11 | 2.58 | 2.20 | 1.98 | .500 |
| V533P-12 | 3/4 | 1-1/4 | .87 | 1.43 | 1.37 | 3.96 | 1.42 | 2.90 | 2.83 | 2.17 | .685 |
| V533P-16 | 1 | 1-9/16 | .87 | 1.62 | 1.37 | 3.96 | 1.58 | 3.21 | 3.16 | 2.32 | .875 |

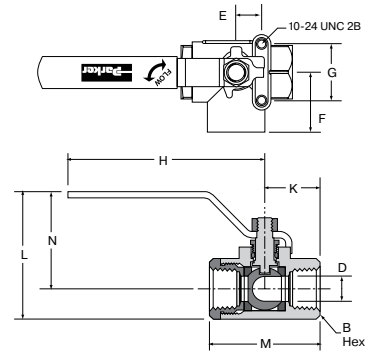

Female-Female-Female-Female Pipe Ends V540P

| PART NO. | PIPE THD (PTF) | B HEX | E | F | G | H | K | L | M | N | FLOW DIA. D |
|----------|----------------|-------|-----|------|------|------|------|------|-----|------|-------------|
| V540P-4 | 1/4 | 7/8 | .32 | 1.00 | 1.76 | 1.25 | 1.98 | 2.49 | .52 | 1.07 | .250 |

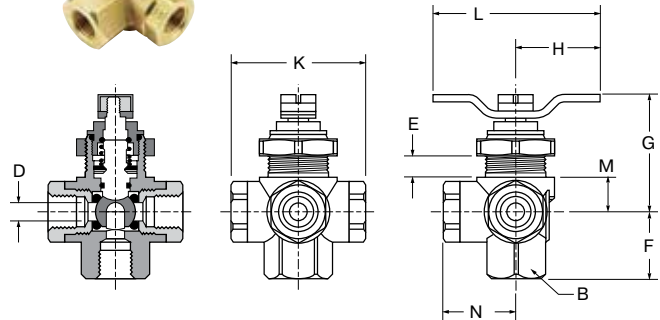

WARNING These products can expose you to chemicals including NICKEL or LEAD, which are known to the state of California to cause cancer, and LEAD which is known to cause birth defects or other reproductive harm. For more information go to www.P65Warnings.ca.gov.



Ball Valves Brass Series 590/591



Product Features:

- Forged brass body
- Chrome plated brass ball
- PTFE seats/seals
- Steel handle

Style:

- V-Valve

Type:

- 590-Male/Female
- 591-Male/Female

Material:

- P-Brass

Options:

- 04-Lever Handle
- 08-Unmarked yellow vinyl handle cover

Specifications:

Pressure Range:

- 250 PSI (17.2 bar)
- Saturated Steam up to 150 PSI (10.3 bar)
- Vacuum Service to 29 Inches Hg

Temperature Range

- -50° to +350° F (-45.5° to +176.6° C)

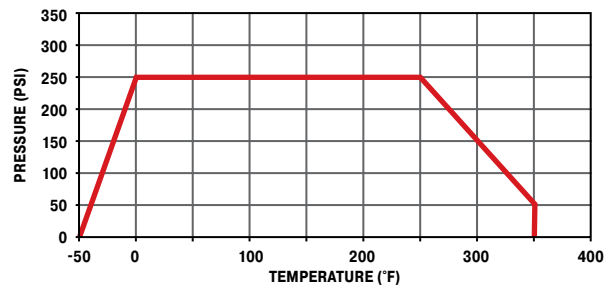

WARNING These products can expose you to chemicals including NICKEL or LEAD, which are known to the state of California to cause cancer, and LEAD which is known to cause birth defects or other reproductive harm. For more information go to www.P65Warnings.ca.gov.



A

B

C

D

E

F

G

H

I

J

K

L

M

N

O

Click here for CADs, Product Specifications or to Configure Parts Online

90° Flow, Male-Female Pipe Ends V590P

| PART NO. | PIPE PTF THREAD | HEX | H | K | L | M | N | D FLOW Ø |
|----------|-----------------|---------|------|------|------|------|------|----------|
| V590P-4 | 1/4 | 15/16 | 1.25 | 1.08 | 2.50 | 1.00 | 2.42 | .375 |
| V590P-6 | 3/8 | 15/16 | 1.25 | 1.09 | 2.50 | 1.00 | 2.43 | .375 |
| V590P-8 | 1/2* | 1-1/16 | 1.25 | 1.30 | 2.50 | 1.08 | 2.67 | .500 |
| V590P-16 | 1** | 1-9/16" | 1.30 | 1.90 | 2.60 | 1.38 | 3.62 | .750 |

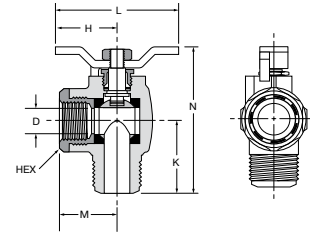

Lever Handle, 90° Flow, Male-Female Pipe Ends V590P-X-04

| PART NO. | PIPE PTF THREAD | HEX | H | K | L | M | N | D FLOW Ø |
|-------------|-----------------|---------|------|------|------|------|------|----------|
| V590P-4-04 | 1/4 | 15/16 | 3.96 | 1.08 | 4.96 | 1.00 | 3.02 | .375 |
| V590P-6-04 | 3/8 | 15/16 | 3.96 | 1.09 | 4.96 | 1.00 | 3.03 | .375 |
| V590P-8-04 | 1/2* | 1-1/16 | 3.80 | 1.30 | 4.88 | 1.08 | 2.95 | .500 |
| V590P-16-04 | 1** | 1-9/16" | 3.96 | 1.90 | 5.34 | 1.38 | 4.17 | .750 |

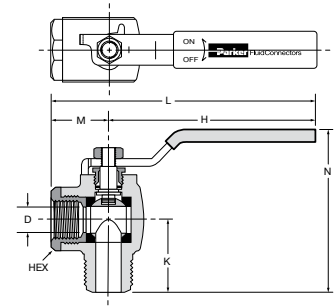

90° Flow, Male-Male Pipe Ends V591P

| PART NO. | PIPE THREAD | HEX | H | K | L | M | N | D FLOW Ø |
|----------|-------------|--------|------|------|------|------|------|----------|
| V591P-4 | 1/4 | 15/16 | 1.25 | 1.08 | 2.50 | 1.56 | 2.42 | .375 |
| V591P-6 | 3/8 | 15/16 | 1.25 | 1.09 | 2.50 | 1.56 | 2.43 | .375 |
| V591P-8 | 1/2 | 1-1/16 | 1.25 | 1.30 | 2.50 | 1.84 | 2.67 | .500 |

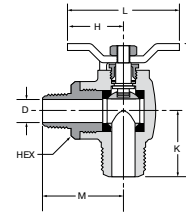

Lever Handle, 90° Flow, Male-Male Pipe Ends V591P-X-04

| PART NO. | PIPE THREAD | HEX | H | K | L | M | N | D FLOW Ø |
|------------|-------------|--------|------|------|------|------|------|----------|
| V591P-4-04 | 1/4 | 15/16 | 3.96 | 1.08 | 5.52 | 1.56 | 3.02 | .375 |
| V591P-6-04 | 3/8 | 15/16 | 3.96 | 1.09 | 5.52 | 1.56 | 3.03 | .375 |
| V591P-8-04 | 1/2 | 1-1/16 | 3.80 | 1.30 | 5.64 | 1.84 | 2.95 | .500 |

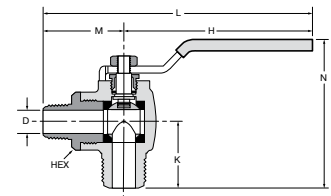

*PTF Special Short. **PTF SPL Extra Short

WARNING These products can expose you to chemicals including NICKEL or LEAD, which are known to the state of California to cause cancer, and LEAD which is known to cause birth defects or other reproductive harm. For more information go to www.P65Warnings.ca.gov.



Ball Valves Brass Series 500HB



Product Features:

- Forged brass body
- Chrome plated brass ball
- PTFE seats/seals
- Steel handle

Style:

- V-Valve

Type:

- 500HB-Female/Beaded Hose Barb

Material:

- P-Brass

Specifications:

Pressure Range:

- 150 PSI (10.3 bar) WOG, Cold Non-Shock
- Saturated Steam up to 150 PSI (10.3 bar)
- Vacuum Service to 29 Inches Hg

Temperature Range

- 0° to +350° F (-17.7° to +176.6° C)

Brass Hose Barb Ball Valve V500P-HB

| PART NO. | PORT 1 | PORT 2 PTF | B HEX | C HEX | H | L | M | N | FLOW DIA. D |
|---------------|--------|------------|-------|--------|------|------|------|------|-------------|
| V500P-12-16HB | 1 | 3/4* | 1-1/4 | 1-5/16 | 3.96 | 6.25 | 3.41 | 2.81 | .685 |

*PTF special extra short

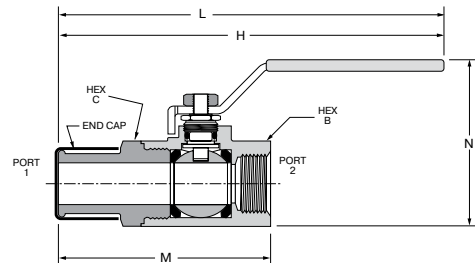

WARNING These products can expose you to chemicals including NICKEL or LEAD, which are known to the state of California to cause cancer, and LEAD which is known to cause birth defects or other reproductive harm. For more information go to www.P65Warnings.ca.gov.



A

B

C

D

E

F

G

H

I

J

K

L

M

N

O

A

B

C

D

E

F

G

H

I

J

K

L

M

N

O

Ball Valves

Brass Series 600



Product Features:

- Forged brass body
- Chrome plated brass ball
- PTFE seats/seals
- Fluorocarbon O-rings
- Steel handle

Style:

- V-Valve

Type:

- 600-Three Position
- 633-Two Position

Material:

- P-Brass

Specifications:

Pressure Range:

- 150 PSI (10.3 bar)
- Vacuum Service to 29 Inches Hg

Temperature Range

- 0° to +250° F (-17.7° to +121.1° C)

Series 600 Handle Positions

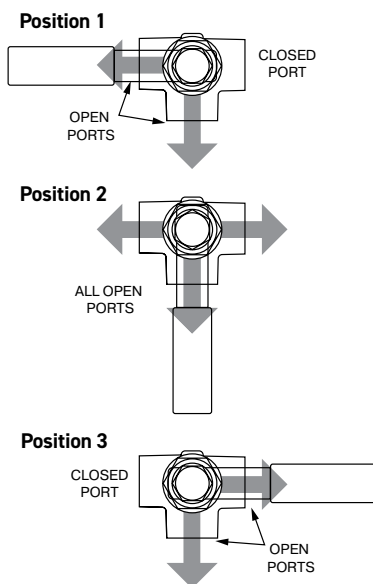

Series 633 Handle Positions

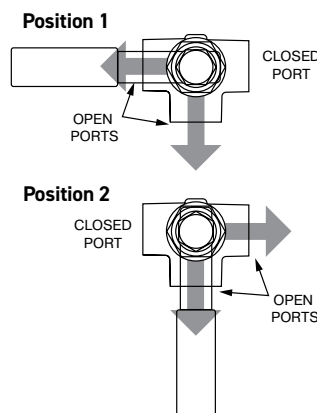

This valve can be used on applications where a fluid return or spillback is required. For use on construction equipment, chemical processing, diesel engines, filter banks, pumps and specialized industrial machinery.

NOTE: Diversion valves do not have off positions, therefore, the center ports can not be used for shut-off purposes.

WARNING These products can expose you to chemicals including NICKEL or LEAD, which are known to the state of California to cause cancer, and LEAD which is known to cause birth defects or other reproductive harm. For more information go to www.P65Warnings.ca.gov.



[Click here for CADs, Product Specifications or to Configure Parts Online](#)

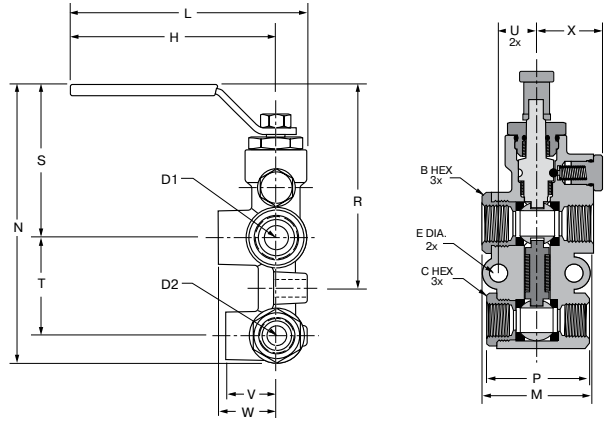

Six Port Diversion Brass Valve V600P

| PIPE THD. PART NO. | PIPE THD. TOP PORT SPL SHORT | BOTTOM PORT PTF | B HEX | C HEX | D1 FLOW | D2 FLOW | E | H | L | M | N | P | R | S | T | U | V | W | X |
|--------------------|------------------------------|-----------------|--------|-------|---------|---------|-----|------|------|------|------|------|------|------|------|-----|-----|------|------|
| V600P-8-6 | 1/2 | 3/8 | 1 1/16 | 15/16 | .500 | .375 | .34 | 3.96 | 4.56 | 2.20 | 5.43 | 2.03 | 3.98 | 2.99 | 1.91 | .73 | .98 | 1.12 | 1.31 |

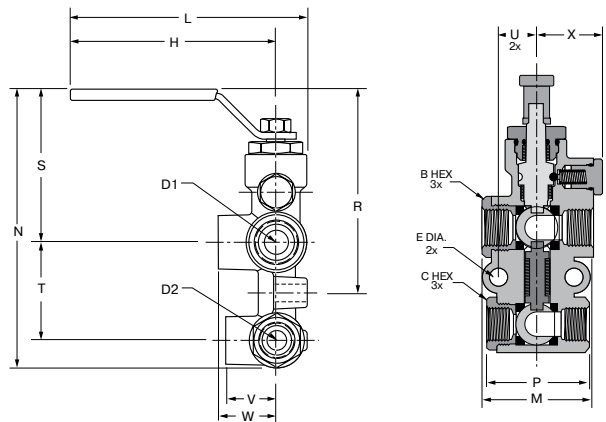

Six Port Diversion Brass Valve V633P

| PIPE THD. PART NO. | PIPE THD. TOP PORT SPL SHORT | BOTTOM PORT PTF | B HEX | C HEX | D1 FLOW | D2 FLOW | E | H | L | M | N | P | R | S | T | U | V | W | X |
|--------------------|------------------------------|-----------------|--------|-------|---------|---------|-----|------|------|------|------|------|------|------|------|-----|-----|------|------|
| V633P-8-6 | 1/2 | 3/8 | 1 1/16 | 15/16 | .500 | .375 | .34 | 3.96 | 4.56 | 2.20 | 5.43 | 2.03 | 3.98 | 2.99 | 1.91 | .73 | .98 | 1.12 | 1.31 |

WARNING These products can expose you to chemicals including NICKEL or LEAD, which are known to the state of California to cause cancer, and LEAD which is known to cause birth defects or other reproductive harm. For more information go to www.P65Warnings.ca.gov.



- A
- B
- C
- D
- E
- F
- G
- H
- I
- J
- K
- L
- M
- N
- O

A
B
C
D
E
F
G
H
I
J
K
L
M
N
O



Ball Valves

Carbon Steel Series 500CS/502CS

Product Features:

- Carbon Steel Phosphate Coated body
- Steel ball
- PTFE seats/seals
- Steel handle

Style:

- V-Valve
- VP-Valve, padlocking handle

Type:

- 500-Female/Female
- 502-Female/Female

Material:

- CS-Carbon Steel

Options:

- 04-Tee Handle
- 21-Oval Handle

Specifications:

Pressure Range:

- 1/4" – 1": 2000 PSI (137.8 bar)
- 1 1/4" – 2": 1500 PSI (103.4 bar)
- Saturated Steam up to 150 PSI (10.3 bar)

Temperature Range

- -20° to +425° F (-28.8° to +218.3° C)

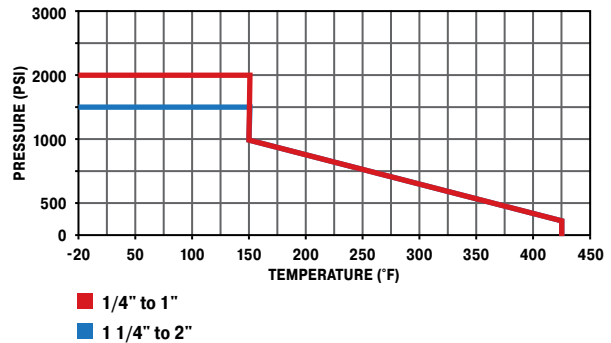

| FLOW DATA | |
|------------|-------|
| VALVE SIZE | CV |
| 1/4 | 6.0 |
| 3/8 | 12.8 |
| 1/2 | 15.0 |
| 3/4 | 23.0 |
| 1 | 36.0 |
| 1-1/4 | 44.0 |
| 1-1/2 | 64.0 |
| 2 | 114.0 |

WARNING These products can expose you to chemicals including NICKEL, which is known to the state of California to cause cancer. For more information go to www.P65Warnings.ca.gov.



Click here for CADs, Product Specifications or to Configure Parts Online

Female-Female Pipe Ends V500CS

| PART NO. | PIPE THREAD | B HEX | C HEX | H | L | M | N | D FLOW Ø |
|-----------|-------------|--------|--------|------|------|------|------|----------|
| V500CS-4 | 1/4 | 1-1/16 | 15/16 | 3.78 | 1.00 | 2.00 | 1.63 | .400 |
| V500CS-6 | 3/8 | 1-1/16 | 15/16 | 3.78 | 1.00 | 2.00 | 1.63 | .400 |
| V500CS-8 | 1/2 | 1-1/4 | 1-1/16 | 3.78 | 1.25 | 2.37 | 1.73 | .540 |
| V500CS-12 | 3/4 | 1-5/8 | 1-3/8 | 5.10 | 1.50 | 2.90 | 2.08 | .680 |
| V500CS-16 | 1 | 2 | 1-5/8 | 5.10 | 1.76 | 3.41 | 2.30 | .880 |

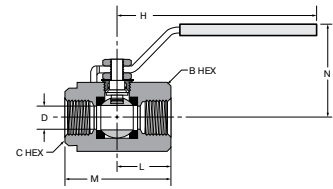

Female-Female Pipe Ends, Panel Mount V502CS

| PART NO. | PIPE THD | B HEX | C HEX | F | G | H | L | M | N | FLOW DIA. D |
|-----------|----------|--------|-------|------|------|------|------|------|------|-------------|
| V502CS-20 | 1-1/4 | 2 | 2-1/4 | .94 | 1.50 | 6.10 | 1.87 | 3.80 | 2.76 | 1.000 |
| V502CS-24 | 1-1/2 | 2-5/16 | 2-1/2 | .94 | 1.50 | 6.10 | 2.27 | 4.55 | 2.98 | 1.250 |
| V502CS-32 | 2 | 2-3/4 | 3 | 1.03 | 2.00 | 8.60 | 2.42 | 4.83 | 3.54 | 1.500 |

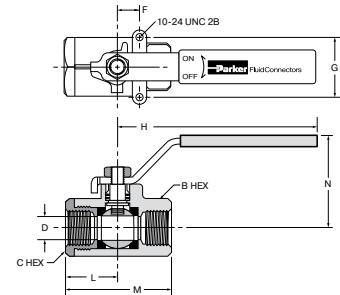

Locking Handle, Female Pipe Ends VP500CS

| PART NO. | PIPE THD | B HEX | C HEX | H | L | M | N | D FLOW Ø |
|------------|----------|--------|--------|------|------|------|------|----------|
| VP500CS-4 | 1/4 | 1-1/16 | 15/16 | 4.13 | 1.00 | 2.00 | 2.23 | .400 |
| VP500CS-6 | 3/8 | 1-1/16 | 15/16 | 4.13 | 1.00 | 2.00 | 2.23 | .400 |
| VP500CS-8 | 1/2 | 1-1/4 | 1-1/16 | 4.13 | 1.25 | 2.37 | 2.33 | .540 |
| VP500CS-12 | 3/4 | 1-5/8 | 1-3/8 | 5.00 | 1.50 | 2.90 | 2.80 | .680 |
| VP500CS-16 | 1 | 2 | 1-5/8 | 5.00 | 1.76 | 3.41 | 2.97 | .880 |

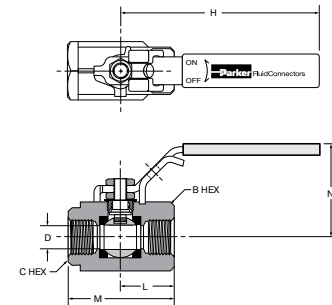

Locking Handle, Female Pipe Ends, Panel Mount VP502CS

| PART NO. | PIPE THD | B HEX | C HEX | F | G | H | L | M | N | FLOW DIA. D |
|------------|----------|--------|-------|------|------|------|------|------|------|-------------|
| VP502CS-20 | 1-1/4 | 2 | 2-1/4 | .94 | 1.50 | 7.50 | 1.87 | 3.80 | 3.15 | 1.000 |
| VP502CS-24 | 1-1/2 | 2-5/16 | 2-1/2 | .94 | 1.50 | 7.50 | 2.27 | 4.55 | 3.37 | 1.250 |
| VP502CS-32 | 2 | 2-3/4 | 3 | 1.03 | 2.00 | 8.75 | 2.42 | 4.83 | 3.46 | 1.500 |

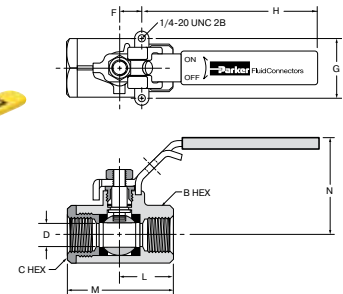

Tee Handle, Female Pipe Ends V500CS-X-04

| PART NO. | PIPE THD | B HEX | C HEX | H | L | M | N | D FLOW Ø |
|--------------|----------|--------|--------|------|------|------|------|----------|
| V500CS-4-04 | 1/4 | 1-1/16 | 15/16 | 2.16 | 1.08 | 2.00 | 1.41 | .400 |
| V500CS-6-04 | 3/8 | 1-1/16 | 15/16 | 2.16 | 1.08 | 2.00 | 1.41 | .400 |
| V500CS-8-04 | 1/2 | 1-1/4 | 1-1/16 | 2.90 | 1.45 | 2.37 | 1.66 | .540 |
| V500CS-12-04 | 3/4 | 1-5/8 | 1-3/8 | 3.63 | 1.81 | 2.90 | 2.06 | .680 |
| V500CS-16-04 | 1 | 2 | 1-5/8 | 3.63 | 1.81 | 3.41 | 2.23 | .880 |

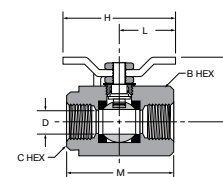

WARNING These products can expose you to chemicals including NICKEL, which is known to the state of California to cause cancer. For more information go to www.P65Warnings.ca.gov.

- A
- B
- C
- D
- E
- F
- G
- H
- I
- J
- K
- L
- M
- N
- O

Click here for CADs, Product Specifications or to Configure Parts Online

Oval Handle, Female Pipe Ends V500CS-X-21

| PART NO. | PIPE THD | B HEX | C HEX | H | L | M | N | D FLOW Ø |
|--------------|----------|--------|--------|------|------|------|------|----------|
| V500CS-4-21 | 1/4 | 1-1/16 | 15/16 | 3.50 | 1.00 | 2.00 | 1.66 | .400 |
| V500CS-6-21 | 3/8 | 1-1/16 | 15/16 | 3.50 | 1.00 | 2.00 | 1.66 | .400 |
| V500CS-8-21 | 1/2 | 1-1/4 | 1-1/16 | 3.50 | 1.13 | 2.37 | 1.76 | .540 |
| V500CS-12-21 | 3/4 | 1-5/8 | 1-3/8 | 5.00 | 1.46 | 2.90 | 2.13 | .680 |
| V500CS-16-21 | 1 | 2 | 1-5/8 | 5.00 | 1.58 | 3.41 | 2.29 | .880 |

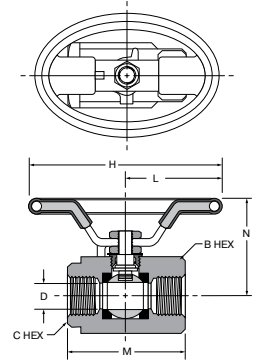

Oval Handle, Female Pipe Ends, Panel Mount V502CS-X-21

| PART NO. | PIPE THD | B HEX | C HEX | F | G | H | L | M | N | FLOW DIA. D |
|--------------|----------|--------|-------|------|------|------|------|------|------|-------------|
| V502CS-20-21 | 1-1/4 | 2 | 2-1/4 | .94 | 1.50 | 5.07 | 2.53 | 3.80 | 3.04 | 1.000 |
| V502CS-24-21 | 1-1/2 | 2-5/16 | 2-1/2 | .94 | 1.50 | 5.07 | 2.53 | 4.55 | 3.26 | 1.250 |
| V502CS-32-21 | 2 | 2-3/4 | 3 | 1.03 | 2.00 | 6.50 | 3.25 | 4.83 | 3.57 | 1.500 |

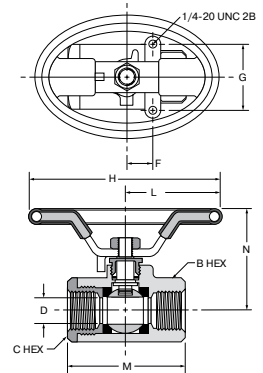

WARNING These products can expose you to chemicals including NICKEL, which is known to the state of California to cause cancer. For more information go to www.P65Warnings.ca.gov.





Ball Valves

Carbon Steel Series 506CS

Product Features:

- Carbon Steel Phosphate Coated body
- Steel ball
- PTFE seats/seals
- Steel handle

Style:

- V-Valve
- VP-Valve, padlocking handle

Type:

- 506-Female/Female SAE Straight Thread Ports

Material:

- CS-Carbon Steel

Options:

- 04-Tee Handle
- 21-Oval Handle

Specifications:

Pressure Range:

- 3000 PSI (206.8 bar)
- Saturated Steam up to 150 PSI (10.3 bar)

Temperature Range

- 20° to +425° F (-28.8° to +218.3° C)

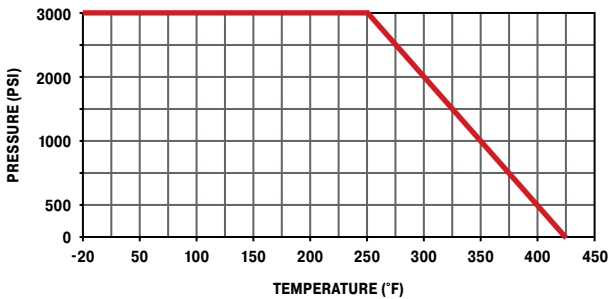

| FLOW DATA | |
|------------|------|
| VALVE SIZE | CV |
| 1/4 | 6.0 |
| 3/8 | 12.0 |
| 1/2 | 15.0 |
| 3/4 | 34.0 |
| 1 | 54.0 |

Female-Female SAE Straight Thread Ports V506CS

| PART NO. | STRAIGHT THREAD | B HEX | C HEX | H | L | M | N | D FLOW Ø |
|-----------|-----------------|--------|-------|------|------|------|------|----------|
| V506CS-4 | 7/16-20 | 1-1/16 | 15/16 | 3.78 | 1.00 | 2.00 | 1.63 | .400 |
| V506CS-6 | 9/16-18 | 1-1/16 | 15/16 | 3.78 | 1.00 | 2.00 | 1.63 | .400 |
| V506CS-8 | 3/4-16 | 1-5/8 | 1-1/4 | 4.78 | 1.32 | 2.84 | 2.16 | .500 |
| V506CS-12 | 1-1/16-12 | 1-7/8 | 1-5/8 | 4.78 | 1.66 | 3.71 | 2.35 | .750 |
| V506CS-16 | 1-5/16-12 | 2-1/2 | 2-1/8 | 6.10 | 1.88 | 4.15 | 2.85 | 1.000 |

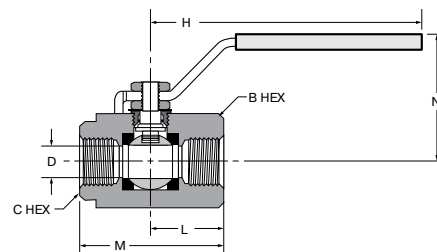

WARNING These products can expose you to chemicals including NICKEL, which is known to the state of California to cause cancer. For more information go to www.P65Warnings.ca.gov.



A

B

C

D

E

F

G

H

I

J

K

L

M

N

O

A
B
C
D
E
F
G
H
I
J
K
L
M
N
O



Ball Valves

Carbon Steel Series 500HP, 506HP

Product Features:

- Carbon Steel Phosphate Coated body
- Steel ball
- Delrin with Molybdenum Disulphide Seats
- Nitrile O-rings Stem Seals
- Steel handle

Style:

- V-Valve
- VP-Valve, padlocking handle

Type:

- 500-Female/Female NPT Ports
- 506-Female/Female SAE Straight Thread Ports

Material:

- HP-High Pressure Carbon Steel

Specifications:

Pressure Range:

- 6000 PSI (413.6 bar)

Temperature Range

- -10° to +210° F (-23.3° to 98.8° C)

Pressure Drop (PSI)

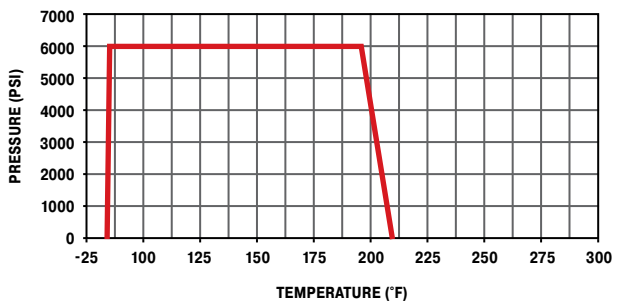
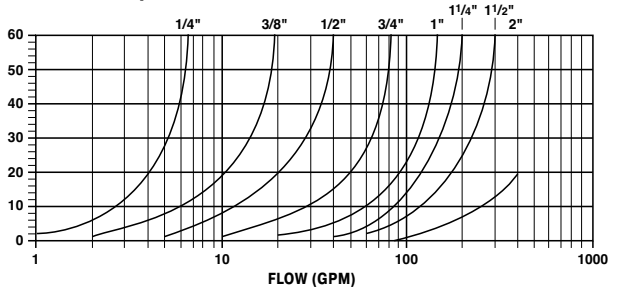

WARNING These products can expose you to chemicals including NICKEL, which is known to the state of California to cause cancer. For more information go to www.P65Warnings.ca.gov.

6000 PSI Female-Female Pipe Ends V500HP-X

| PART NO. | PIPE THREAD [NPT] | B | C | H | L | M | N | FLOW DIA. D |
|-----------|-------------------|-----|------|------|------|------|------|-------------|
| V500HP-4 | 1/4-18 | .69 | 1.38 | 4.50 | 1.44 | 2.75 | 2.94 | .240 |
| V500HP-6 | 3/8-18 | .56 | 1.50 | 4.50 | 1.69 | 2.88 | 3.06 | .390 |
| V500HP-8 | 1/2-14 | .75 | 1.63 | 4.50 | 1.88 | 3.38 | 3.19 | .510 |
| V500HP-12 | 3/4-14 | .69 | 2.25 | 7.00 | 2.41 | 3.81 | 4.69 | .790 |
| V500HP-16 | 1-11.5 | .94 | 2.50 | 7.00 | 2.56 | 4.50 | 4.94 | .950 |

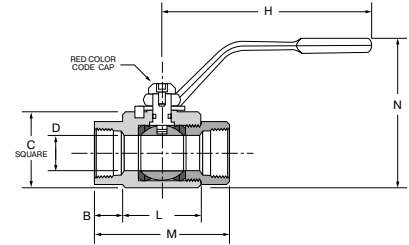

6000 PSI Female-Female Pipe Ends V500HP-X (LARGE)

| PART NO. | PIPE THREAD [NPT] | B | C | H | L | M | N | FLOW DIA. D |
|-----------|-------------------|------|------|-------|------|------|------|-------------|
| V500HP-20 | 1 1/4-11.5 | .85 | 3.25 | 10.00 | 3.15 | 4.84 | 6.31 | 1.26 |
| V500HP-24 | 1 1/2-11.5 | .99 | 3.75 | 10.00 | 3.35 | 5.33 | 6.76 | 1.50 |
| V500HP-32 | 2-11.5 | 1.30 | 4.50 | 10.00 | 3.94 | 6.54 | 7.42 | 1.89 |

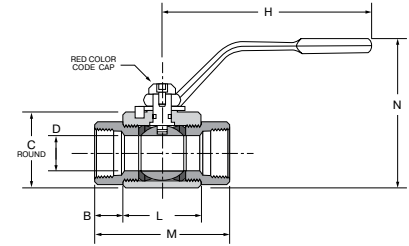

6000 PSI Locking-Female-Female Pipe Ends VP500HP-X

| PART NO. | PIPE THREAD [NPT] | B | C | H | L | M | N | FLOW DIA. D |
|------------|-------------------|-----|------|------|------|------|------|-------------|
| VP500HP-4 | 1/4-18 | .69 | 1.38 | 4.50 | 1.44 | 2.75 | 2.94 | .240 |
| VP500HP-6 | 3/8-18 | .56 | 1.50 | 4.50 | 1.69 | 2.88 | 3.06 | .390 |
| VP500HP-8 | 1/2-14 | .75 | 1.63 | 4.50 | 1.88 | 3.38 | 3.19 | .510 |
| VP500HP-12 | 3/4-14 | .69 | 2.25 | 7.00 | 2.41 | 3.81 | 4.69 | .790 |
| VP500HP-16 | 1-11.5 | .94 | 2.50 | 7.00 | 2.56 | 4.50 | 4.94 | .950 |

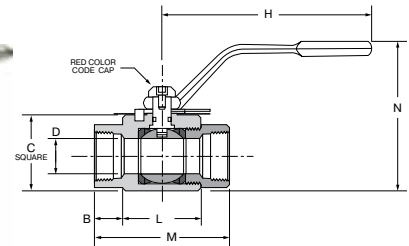

6000 PSI Locking-Female-Female Pipe Ends VP500HP-X (LARGE)

| PART NO. | PIPE THREAD [NPT] | B | C | H | L | M | N | FLOW DIA. D |
|------------|-------------------|------|------|-------|------|------|------|-------------|
| VP500HP-20 | 1 1/4-11.5 | .85 | 3.25 | 10.00 | 3.15 | 4.84 | 6.31 | 1.26 |
| VP500HP-24 | 1 1/2-11.5 | .99 | 3.75 | 10.00 | 3.35 | 5.33 | 6.76 | 1.50 |
| VP500HP-32 | 2-11.5 | 1.30 | 4.50 | 10.00 | 3.94 | 6.54 | 7.42 | 1.89 |

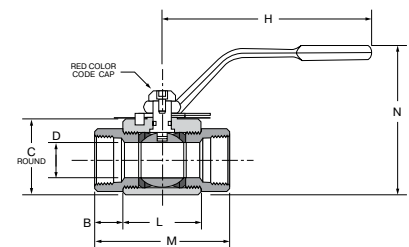

WARNING These products can expose you to chemicals including NICKEL, which is known to the state of California to cause cancer. For more information go to www.P65Warnings.ca.gov.



- A
- B
- C
- D
- E
- F
- G
- H
- I
- J
- K
- L
- M
- N
- O

6000 PSI Female-Female Straight Thread Ends V506HP-X

| PART NO. | SAE J1926-1 THREAD | B | C | H | L | M | N | FLOW DIA. D |
|-----------|--------------------|-----|------|------|------|------|------|-------------|
| V506HP-4 | 7/16-20 UNF | .69 | 1.38 | 4.50 | 1.44 | 2.75 | 2.94 | .240 |
| V506HP-6 | 9/16-18 UNF | .56 | 1.50 | 4.50 | 1.69 | 2.88 | 3.06 | .390 |
| V506HP-8 | 3/4-16 UNF | .75 | 1.63 | 4.50 | 1.88 | 3.38 | 3.19 | .510 |
| V506HP-12 | 1 1/16-12 UNF | .69 | 2.25 | 7.00 | 2.41 | 3.81 | 4.69 | .790 |
| V506HP-16 | 1 5/16-12 UNF | .94 | 2.50 | 7.00 | 2.56 | 4.50 | 4.94 | .950 |

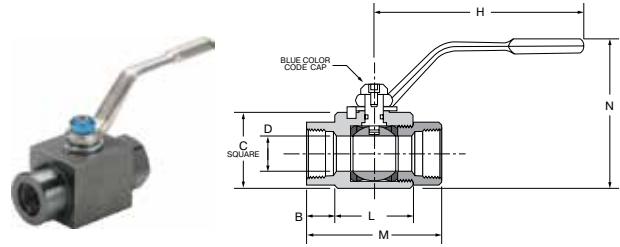

6000 PSI Female-Female Straight Thread Ends V506HP-X (LARGE)

| PART NO. | SAE J1926-1 THREAD | B | C | H | L | M | N | FLOW DIA. D |
|-----------|--------------------|------|------|-------|------|------|------|-------------|
| V506HP-20 | 1 5/8-12 UNF | .85 | 3.25 | 10.00 | 3.15 | 4.84 | 6.31 | 1.26 |
| V506HP-24 | 1 7/8-12 UNF | .99 | 3.75 | 10.00 | 3.35 | 5.33 | 6.76 | 1.50 |
| V506HP-32 | 2 1/2-12 UNF | 1.30 | 4.50 | 10.00 | 3.94 | 6.54 | 7.42 | 1.89 |

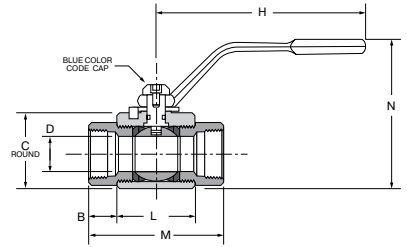

6000 PSI Locking-Female-Female Straight Thread Ends VP506HP-X

| PART NO. | SAE J1926-1 THREAD | B | C | H | L | M | N | FLOW DIA. D |
|------------|--------------------|-----|------|------|------|------|------|-------------|
| VP506HP-4 | 7/16-20 UNF | .69 | 1.38 | 4.50 | 1.44 | 2.75 | 2.94 | .240 |
| VP506HP-6 | 9/16-18 UNF | .56 | 1.50 | 4.50 | 1.69 | 2.88 | 3.06 | .390 |
| VP506HP-8 | 3/4-16 UNF | .75 | 1.63 | 4.50 | 1.88 | 3.38 | 3.19 | .510 |
| VP506HP-12 | 1 1/16-12 UNF | .69 | 2.25 | 7.00 | 2.41 | 3.81 | 4.69 | .790 |
| VP506HP-16 | 1 5/16-12 UNF | .94 | 2.50 | 7.00 | 2.56 | 4.50 | 4.94 | .950 |

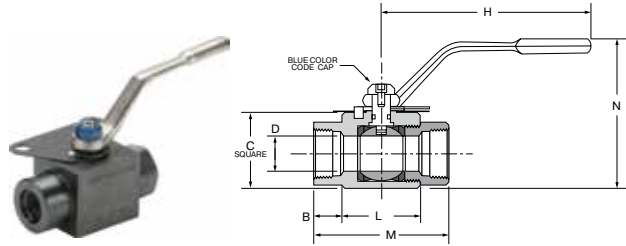

6000 PSI Locking-Female-Female Straight Thread Ends VP506HP-X (LARGE)

| PART NO. | SAE J1926-1 THREAD | B | C | H | L | M | N | FLOW DIA. D |
|------------|--------------------|------|------|-------|------|------|------|-------------|
| VP506HP-20 | 1 5/8-12 UNF | .85 | 3.25 | 10.00 | 3.15 | 4.84 | 6.31 | 1.26 |
| VP506HP-24 | 1 7/8-12 UNF | .99 | 3.75 | 10.00 | 3.35 | 5.33 | 6.76 | 1.50 |
| VP506HP-32 | 2 1/2-12 UNF | 1.30 | 4.50 | 10.00 | 3.94 | 6.54 | 7.42 | 1.89 |

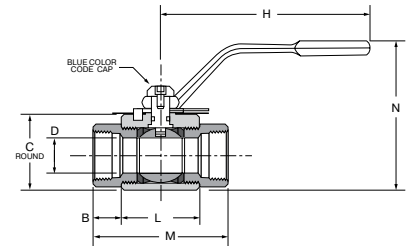

WARNING These products can expose you to chemicals including NICKEL, which is known to the state of California to cause cancer. For more information go to www.P65Warnings.ca.gov.



Ball Valves

Stainless Steel Series 501SS

Product Features:

- CF-8M Stainless Steel body
- Stainless Steel ball
- PTFE Seats/Seals
- Stainless Steel handle
- Silicone Free

Material:

- SS – Stainless Steel

Options

- 20-Short Handle
- 21-Oval Handle
- 35-Welded Retainer Nut

Specifications:

Pressure Range:

- 2000 PSI (137.8 bar)
- Vacuum service 28 inches Hg

Temperature Range

- 0° to +400° F (-17.7° to +204.4° C)

Approvals

- Meets material requirements of NACE MR-01-75

Style:

- V-Valve

Type:

- 501-Male/Female NPT Ports

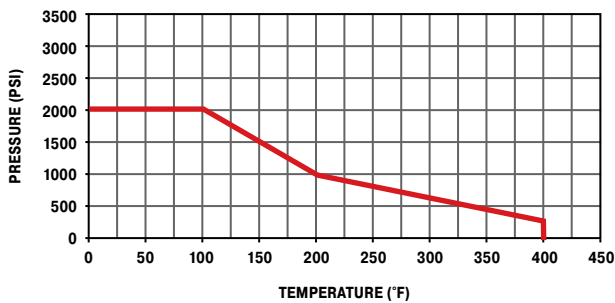

| FLOW DATA | |
|------------|------|
| VALVE SIZE | CV |
| 1/4 | 4.0 |
| 3/8 | 6.0 |
| 1/2 | 14.0 |
| 3/4 | 35.0 |
| 1 | 54.0 |

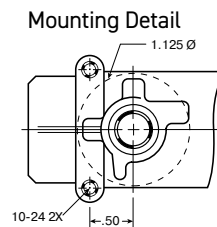

Male-Female Pipe Ends V501SS

| PART NO. | PIPE THREAD [NPT] | HEX | F | G | L | M | N | D FLOW Ø |
|-----------|-------------------|--------|-----|------|------|------|------|----------|
| V501SS-4 | 1/4 | 15/16 | .50 | 1.12 | 5.60 | 2.65 | 1.97 | .280 |
| V501SS-6 | 3/8 | 15/16 | .50 | 1.12 | 5.60 | 2.65 | 1.97 | .375 |
| V501SS-8 | 1/2 | 1-1/16 | .50 | 1.12 | 5.85 | 3.05 | 2.00 | .500 |
| V501SS-12 | 3/4 | 1-3/8 | .88 | 1.37 | 7.27 | 3.85 | 2.55 | .720 |
| V501SS-16 | 1 | 1-5/8 | .88 | 1.37 | 7.48 | 4.25 | 2.68 | .940 |

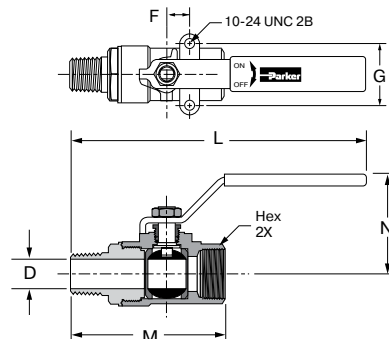

WARNING These products can expose you to chemicals including NICKEL, which is known to the state of California to cause cancer. For more information go to www.P65Warnings.ca.gov.



A

B

C

D

E

F

G

H

I

J

K

L

M

N

O

A
B
C
D
E
F
G
H
I
J
K
L
M
N
O



Ball Valves

Stainless Steel Series 502SS

Product Features:

- CF-8M Stainless Steel body
- Stainless Steel ball
- PTFE Seats/Seals
- Stainless Steel handle
- Silicone Free

Style:

- V-Valve
- VP-Valve, Padlocking

Type:

- 502-Panel Mount Female/
Female NPT Ports

Material:

- SS – Stainless Steel

Options

- 20-Short Handle
- 21-Oval Handle
- 35-Welded Retainer Nut

Specifications:

Pressure Range:

- 1/4" – 1": 2000 PSI (137.8 bar)
- 1 1/4" – 2": 1500 PSI (103.4 bar)
- Vacuum service 28 inches Hg

Temperature Range

- 0° to +400° F (-17.7° to +204.4° C)

Approvals

- Meets material requirements of NACE MR-01-75

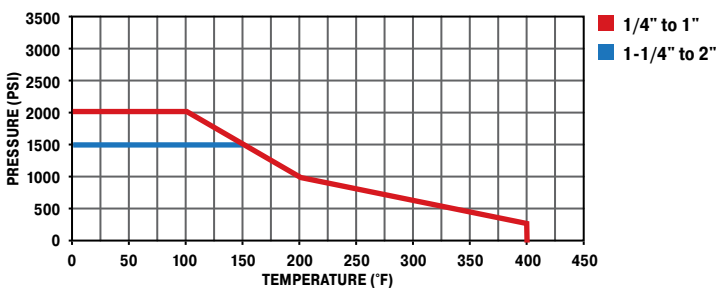

| FLOW DATA | |
|------------|-------|
| VALVE SIZE | CV |
| 1/4 | 4.0 |
| 3/8 | 6.0 |
| 1/2 | 14.0 |
| 3/4 | 35.0 |
| 1 | 54.0 |
| 1 1/4 | 74.0 |
| 1 1/2 | 120.0 |
| 2 | 226.0 |

| MOUNTING HOLE DIAMETER | |
|------------------------|----------|
| VALVE SIZE | DIA. IN. |
| 1/4 | 1.125 |
| 3/8 | 1.125 |
| 1/2 | 1.125 |
| 3/4 | 1.500 |
| 1 | 1.500 |
| 1 1/4 | 1.875 |
| 1 1/2 | 1.875 |
| 2 | 1.875 |

Mounting Detail

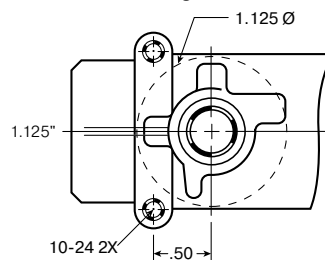

Note: Periodically check the adjustable packing nut and tighten as required.

WARNING These products can expose you to chemicals including NICKEL, which is known to the state of California to cause cancer. For more information go to www.P65Warnings.ca.gov.



Click here for CADs, Product Specifications or to Configure Parts Online

Female Pipe Ends, Panel Mount V502SS

| PART NO. | PIPE THD (NPT) | B/C HEX | F | G | H | I THREAD | L | M | N | PANEL FLOW DIA. D | HOLE DIA. |
|-----------|----------------|---------|-------|-------|------|------------|------|------|------|-------------------|-----------|
| V502SS-4 | 1/4 | 15/16 | .500 | 1.125 | 4.00 | 10-24 UNC | 5.03 | 2.07 | 2.52 | .380 | 1.125 |
| V502SS-6 | 3/8 | 15/16 | .500 | 1.125 | 4.00 | 10-24 UNC | 5.03 | 2.07 | 2.52 | .380 | 1.125 |
| V502SS-8 | 1/2 | 1-1/16 | .500 | 1.125 | 4.00 | 10-24 UNC | 5.13 | 2.27 | 2.65 | .500 | 1.125 |
| V502SS-12 | 3/4 | 1-3/8 | .875 | 1.375 | 5.00 | 10-24 UNC | 6.67 | 3.35 | 3.46 | .790 | 1.500 |
| V502SS-16 | 1 | 1-5/8 | .875 | 1.375 | 5.00 | 10-24 UNC | 6.77 | 3.54 | 3.74 | 1.000 | 1.500 |
| V502SS-20 | 1-1/4 | 2 | 1.000 | 1.500 | 7.00 | 1/4-20 UNC | 9.00 | 4.00 | 4.55 | 1.250 | 2.000 |
| V502SS-24 | 1-1/2 | 2-3/8 | 1.000 | 1.500 | 7.00 | 1/4-20 UNC | 7.19 | 4.38 | 5.42 | 1.500 | 2.000 |
| V502SS-32 | 2 | 3 | 1.000 | 1.500 | 7.00 | 1/4-20 UNC | 9.75 | 5.50 | 5.68 | 2.000 | 2.000 |

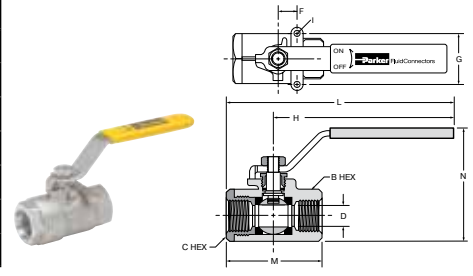

Short Handle, Female Pipe Ends, Panel Mount V502SS-X-20

| PART NO. | PIPE THD [NPT] | B/C HEX | G | H | L | M | N | FLOW DIA. D |
|-------------|----------------|---------|------|------|------|------|------|-------------|
| V502SS-4-20 | 1/4 | 15/16 | 1.12 | 2.28 | 3.32 | 2.07 | 2.53 | .375 |
| V502SS-6-20 | 3/8 | 15/16 | 1.12 | 2.28 | 3.32 | 2.07 | 2.53 | .375 |
| V502SS-8-20 | 1/2 | 1-1/16 | 1.12 | 2.22 | 3.37 | 2.25 | 2.63 | .500 |

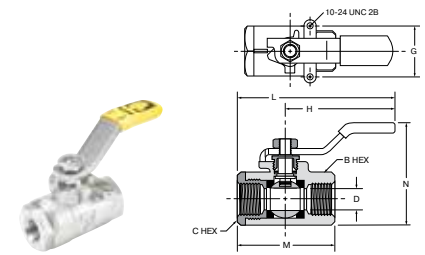

Locking Handle, Female Pipe Ends, Panel Mount VP502SS

| PART NO. | PIPE THD (NPT) | B/C HEX | F | G | H | I THREAD | L | M | N | PANEL FLOW DIA. D | HOLE DIA. |
|------------|----------------|---------|-------|-------|------|------------|------|------|------|-------------------|-----------|
| VP502SS-4 | 1/4 | 15/16 | .500 | 1.125 | 4.00 | 10-24 UNC | 5.03 | 2.07 | 2.52 | .380 | 1.125 |
| VP502SS-6 | 3/8 | 15/16 | .500 | 1.125 | 4.00 | 10-24 UNC | 5.03 | 2.07 | 2.52 | .380 | 1.125 |
| VP502SS-8 | 1/2 | 1-1/16 | .500 | 1.125 | 4.00 | 10-24 UNC | 5.13 | 2.27 | 2.65 | .500 | 1.125 |
| VP502SS-12 | 3/4 | 1-3/8 | .875 | 1.375 | 5.00 | 10-24 UNC | 6.67 | 3.35 | 3.46 | .790 | 1.500 |
| VP502SS-16 | 1 | 1-5/8 | .875 | 1.375 | 5.00 | 10-24 UNC | 6.77 | 3.54 | 3.74 | 1.000 | 1.500 |
| VP502SS-20 | 1-1/4 | 2 | 1.000 | 1.500 | 7.00 | 1/4-20 UNC | 9.00 | 4.00 | 4.55 | 1.250 | 2.000 |
| VP502SS-24 | 1-1/2 | 2-3/8 | 1.000 | 1.500 | 7.00 | 1/4-20 UNC | 7.19 | 4.38 | 5.42 | 1.500 | 2.000 |
| VP502SS-32 | 2 | 3 | 1.000 | 1.500 | 7.00 | 1/4-20 UNC | 9.75 | 5.50 | 5.68 | 2.000 | 2.000 |

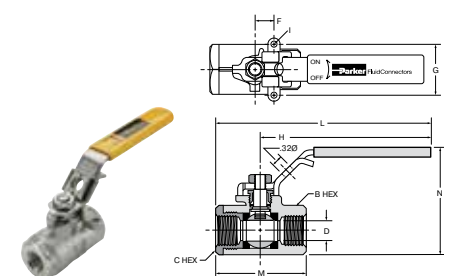

Oval Handle, Female Pipe Ends, Panel Mount V502SS-X-21

| PART NO. | PIPE THD (NPT) | B/C HEX | G | H | L | I THREAD | M | N | PANEL FLOW DIA. D | HOLE DIA. |
|--------------|----------------|---------|-------|------|------|-----------|------|------|-------------------|-----------|
| V502SS-4-21 | 1/4 | 15/16 | 1.125 | 1.74 | 3.48 | 10-24 UNC | 2.07 | 2.43 | .380 | 1.125 |
| V502SS-6-21 | 3/8 | 15/16 | 1.125 | 1.74 | 3.48 | 10-24 UNC | 2.07 | 2.43 | .380 | 1.125 |
| V502SS-8-21 | 1/2 | 1-1/16 | 1.125 | 1.74 | 3.48 | 10-24 UNC | 2.27 | 2.54 | .500 | 1.125 |
| V502SS-12-21 | 3/4 | 1-3/8 | 1.375 | 2.68 | 5.36 | 10-24 UNC | 3.35 | 3.45 | .790 | 1.500 |
| V502SS-16-21 | 1 | 1-5/8 | 1.375 | 2.68 | 5.36 | 10-24 UNC | 3.54 | 3.74 | 1.000 | 1.500 |

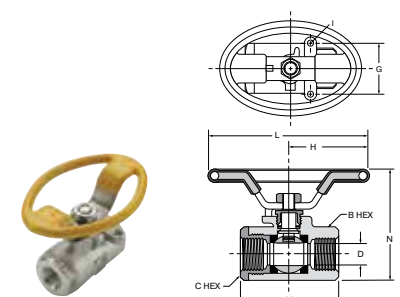

WARNING These products can expose you to chemicals including NICKEL, which is known to the state of California to cause cancer. For more information go to www.P65Warnings.ca.gov.

- A
- B
- C
- D
- E
- F
- G
- H
- I
- J
- K
- L
- M
- N
- O

Ball Valves

Micro Series 708/709



Product Features:

- Brass Body
- Chrome Plated Brass Ball
- PTFE Seats/Seals
- Nitrile Stem Seal
- Chrome Plated Steel Handle

Style:

- MV-Micro Valve

Type:

- 708-Male/Female
- 709-Female/Female

Specifications:

Pressure Range:

- Up to 500 PSI (34.4 bar)
- Vacuum service 29 inches Hg

Temperature Range

- -35° to +300° F (-37.2 to +148.8° C)



| FLOW DATA | | |
|------------|----------|----------|
| VALVE SIZE | MV708 CV | MV709 CV |
| 1/4 | .95 | .95 |

Male-Female Pipe Ends, Mini Ball Valve MV708

| PART NO. | PIPE THREAD | B HEX | H | L | M | N | P | FLOW DIA. D |
|----------|-------------|-------|------|-----|------|-----|-----|-------------|
| MV708-2 | 1/8 | 9/16 | 1.18 | .63 | 1.62 | .93 | .38 | .180 |
| MV708-4 | 1/4 | 11/16 | 1.52 | .70 | 1.57 | .79 | .50 | .210 |

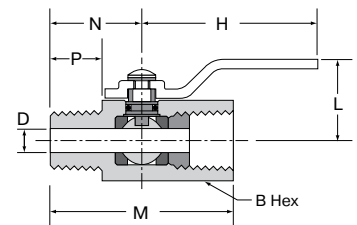

Female Pipe Ends, Mini Ball Valve MV709

| PART NO. | PIPE THREAD | B HEX | H | L | M | N | FLOW DIA. D |
|----------|-------------|-------|------|-----|------|-----|-------------|
| MV709-2 | 1/8 | 9/16 | 1.18 | .63 | 1.52 | .68 | .180 |
| MV709-4 | 1/4 | 11/16 | 1.52 | .70 | 1.57 | .76 | .210 |

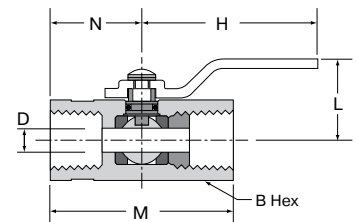

WARNING These products can expose you to chemicals including NICKEL or LEAD, which are known to the state of California to cause cancer, and LEAD which is known to cause birth defects or other reproductive harm. For more information go to www.P65Warnings.ca.gov.





Ball Valves

Mini Series 200/608/609

Product Features:

- Chrome Plated Brass Body
- Chrome Plated Brass Ball
- PTFE Seats/Seals
- Fluorocarbon Stem Seal
- 608/609 Polyamide Wedge Handle
- 200 Polyamide Lever Handle

Style:

- MV-Mini Valve

Type:

- 608-Male/Female
- 609-Female/Female
- 200-Female/Female
- 21-Oval Handle

Specifications:

Pressure Range:

- MV200: 200 PSI (13.7 bar)
- MV608/609: Vacuum Service 28 Inches Hg
- MV608/609: 450 PSI (31.0 bar)

Temperature Range

- 0° to +200° F (-17.7° to +93.3° C)

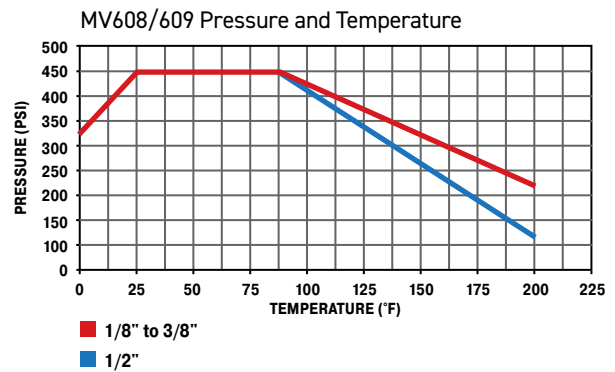
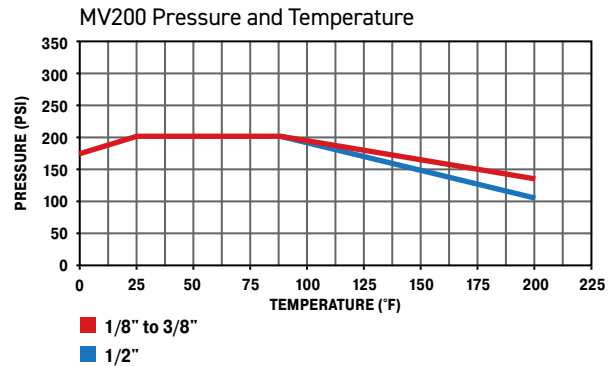

| FLOW DATA | | | |
|------------|----------|----------|----------|
| VALVE SIZE | MV200 CV | MV608 CV | MV609 CV |
| 1/8 | 1.3 | 1.2 | 1.4 |
| 1/4 | 4.0 | 5.8 | 4.3 |
| 3/8 | 3.7 | 3.9 | 3.6 |
| 1/2 | 5.8 | 5.6 | 6.0 |

WARNING These products can expose you to chemicals including NICKEL or LEAD, which are known to the state of California to cause cancer, and LEAD which is known to cause birth defects or other reproductive harm. For more information go to www.P65Warnings.ca.gov.



Click here for CADs, Product Specifications or to Configure Parts Online

Female Pipe Ends, Lever Handle, Mini Ball Valve MV200

| PART NO. | PIPE THREAD | HEX | B | C | H | L | FLOW DIA. D |
|----------|-------------|-----|------|------|------|------|-------------|
| MV200-2 | 1/8 | .83 | 1.71 | 1.20 | .91 | 2.83 | .31 |
| MV200-4 | 1/4 | .83 | 1.71 | 1.20 | .91 | 2.83 | .31 |
| MV200-6 | 3/8 | .83 | 1.71 | 1.20 | .91 | 2.83 | .31 |
| MV200-8 | 1/2 | .98 | 2.11 | 1.28 | 1.10 | 2.83 | .39 |

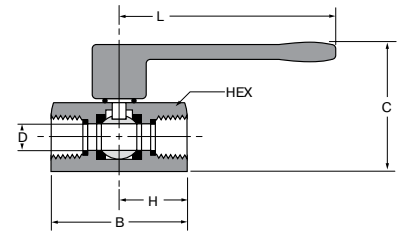

Male-Female Pipe Ends, Compact Handle, Mini Ball Valve MV608

| PART NO. | PIPE THREAD | A HEX | B | C | FLOW DIA. D |
|----------|-------------|-------|------|------|-------------|
| MV608-2 | 1/8 | .83 | 1.72 | 1.22 | .20 |
| MV608-4 | 1/4 | .83 | 1.72 | 1.22 | .31 |
| MV608-6 | 3/8 | .83 | 1.72 | 1.22 | .31 |
| MV608-8 | 1/2 | .98 | 2.11 | 1.30 | .39 |

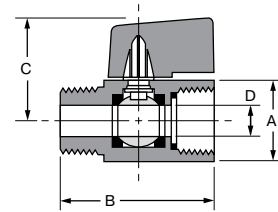

Female Pipe Ends, Compact Handle, Mini Ball Valve MV609

| PART NO. | PIPE THREAD | A HEX | B | C | FLOW DIA. D |
|-----------|-------------|-------|------|------|-------------|
| MV609-2 | 1/8 | .83 | 1.71 | 1.22 | .24 |
| MV609-4 | 1/4 | .83 | 1.71 | 1.22 | .31 |
| MV609-6 | 3/8 | .83 | 1.71 | 1.22 | .31 |
| MV609-8 | 1/2 | .98 | 2.11 | 1.30 | .39 |
| MV609-6-4 | 3/8X1/4 | .83 | 1.71 | 1.22 | .31 |

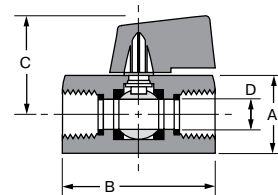

WARNING These products can expose you to chemicals including NICKEL or LEAD, which are known to the state of California to cause cancer, and LEAD which is known to cause birth defects or other reproductive harm. For more information go to www.P65Warnings.ca.gov.

Ball Valves Polypropylene



Parker's Polypropylene Ball Valves offers a corrosion-resistant, all plastic design making them ideal for water filtration units, coffee and beverage machines and a wide variety of other fluid applications.

Product Features:

- Wide chemical acceptance range
- Bi-directional flow maximizes productivity
- Full flow reduces pressure drop across valve
- EPDM Seals – LIQUIfit, TrueSeal, and Par-barb
- Nitrile Seals – Fast and Tite
- Push-in and barbed connections
- Meets FDA and NSF/ANSI 51 requirements for food contact
- LIQUIfit, Par-Barb, and TrueSeal meet NSF/ANSI 61 requirements

Advantages:

- Reduce costs – Built in LIQUIfit, TrueSeal and Par-Barb connections eliminates the need for a secondary fitting.
- Save Space – Low-profile design allows for easy assembly and access where space is a concern.

Type:

- LFPP – LIQUIfit
- PP – TrueSeal
- PBPP – Par-Barb
- FTTPB - Fast and Tite

Specifications:

Pressure Range Up to 150 PSI (10.3 bar)

Temperature Range 35° to +200° F (+1.7° to +93.3° C)



WARNING These products can expose you to chemicals including CARBON BLACK, or LEAD, which are known to the state of California to cause cancer, and LEAD which is known to cause birth defects or other reproductive harm. For more information go to www.P65Warnings.ca.gov.



A

B

C

D

E

F

G

H

I

J

K

L

M

N

O

Click here for CADs, Product Specifications or to Configure Parts Online

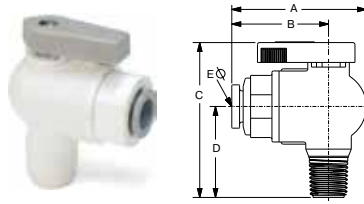

VME - Valve Male Elbow

| PART NO. | NOM. TUBE O.D. | NPTF THREAD SIZE | A | B | C | D | Ø THRU HOLE MIN. |
|-----------|----------------|------------------|------|------|------|------|------------------|
| LFPP4VME2 | 1/4 | 1/8 | 1.74 | 1.21 | 2.00 | 1.10 | .19 |
| LFPP4VME4 | 1/4 | 1/4 | 1.74 | 1.21 | 2.18 | 1.28 | .19 |
| LFPP4VME6 | 1/4 | 3/8 | 1.74 | 1.21 | 2.18 | 1.28 | .19 |
| LFPP4VME8 | 1/4 | 1/2 | 1.74 | 1.21 | 2.37 | 1.47 | .19 |
| LFPP6VME2 | 3/8 | 1/8 | 1.85 | 1.32 | 2.00 | 1.10 | .25 |
| LFPP6VME4 | 3/8 | 1/4 | 1.85 | 1.32 | 2.18 | 1.28 | .25 |
| LFPP6VME6 | 3/8 | 3/8 | 1.85 | 1.32 | 2.18 | 1.28 | .25 |
| LFPP6VME8 | 3/8 | 1/2 | 1.85 | 1.32 | 2.37 | 1.47 | .25 |

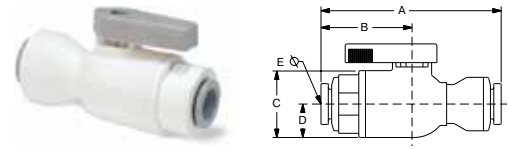

VUC - Valve Union Connector Metric

| PART NO. | 1 TUBE SIZE MM | 2 TUBE SIZE MM | A MM | B MM | C MM | D MM | Ø THRU HOLE MIN. MM |
|---------------|----------------|----------------|------|------|------|------|---------------------|
| LFPP6MVUC6M | 6 | 6 | .57 | .27 | .36 | .13 | .19 |
| LFPP8MVUC8M | 8 | 8 | .60 | .27 | .36 | .13 | .25 |
| LFPP10MVUC10M | 10 | 10 | .70 | .33 | .36 | .13 | .33 |
| LFPP12MVUC12M | 12 | 12 | .88 | .43 | .36 | .13 | .37 |

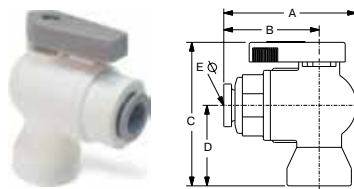

VFE - Valve Female Elbow

| PART NO. | NOM. TUBE O.D. | NPTF THREAD SIZE | A | B | C | D | Ø THRU HOLE MIN. |
|-----------|----------------|------------------|------|------|------|------|------------------|
| LFPP4VFE2 | 1/4 | 1/8 | 1.74 | 1.21 | 1.82 | .92 | .19 |
| LFPP4VFE4 | 1/4 | 1/4 | 1.74 | 1.21 | 2.05 | 1.15 | .19 |
| LFPP4VFE6 | 1/4 | 3/8 | 1.74 | 1.21 | 2.18 | 1.28 | .19 |
| LFPP6VFE2 | 3/8 | 1/8 | 1.85 | 1.32 | 1.82 | .92 | .25 |
| LFPP6VFE4 | 3/8 | 1/4 | 1.85 | 1.32 | 2.05 | 1.15 | .25 |
| LFPP6VFE6 | 3/8 | 3/8 | 1.85 | 1.32 | 2.18 | 1.28 | .25 |

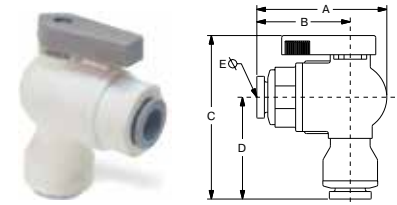

VEU - Valve Elbow Union

| PART NO. | 1 TUBE SIZE | 2 TUBE SIZE | A | B | C | D | Ø THRU HOLE MIN. |
|-----------|-------------|-------------|------|------|------|------|------------------|
| LFPP4VEU4 | 1/4 | 1/4 | 1.75 | 1.22 | 2.33 | 1.42 | .19 |
| LFPP4VEU6 | 1/4 | 3/8 | 1.75 | 1.22 | 2.33 | 1.42 | .11 |
| LFPP6VEU4 | 3/8 | 1/4 | 1.83 | 1.30 | 2.32 | 1.40 | .19 |
| LFPP6VEU6 | 3/8 | 3/8 | 1.85 | 1.32 | 2.34 | 1.44 | .25 |

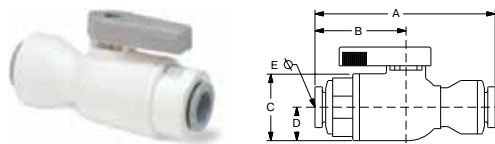

VUC - Valve Union Connector

| PART NO. | 1 TUBE SIZE | 2 TUBE SIZE | A | B | C | D | Ø THRU HOLE MIN. |
|-----------|-------------|-------------|------|------|-----|----|------------------|
| LFPP4VUC4 | 1/4 | 1/4 | 2.55 | 1.22 | 1.0 | .5 | .19 |
| LFPP4VUC6 | 1/4 | 3/8 | 2.57 | 1.30 | 1.0 | .5 | .19 |
| LFPP6VUC6 | 3/8 | 3/8 | 2.67 | 1.32 | 1.4 | .5 | .25 |

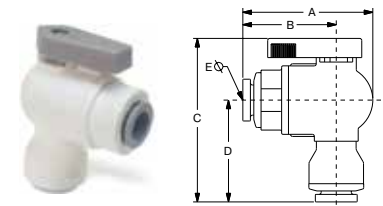

VEU - Valve Elbow Union Metric

| PART NO. | 1 TUBE SIZE MM | 2 TUBE SIZE MM | A MM | B MM | C MM | D MM | Ø THRU HOLE MIN. MM |
|---------------|----------------|----------------|------|------|------|------|---------------------|
| LFPP6MVEU6M | 6 | 6 | .41 | .27 | .55 | .31 | .19 |
| LFPP8MVEU8M | 8 | 8 | .41 | .28 | .56 | .33 | .25 |
| LFPP10MVEU10M | 10 | 10 | .48 | .33 | .61 | .38 | .33 |

NOTE: PPL refers to Polypropylene. FCB refers to Fluorocarbon.

WARNING These products can expose you to chemicals including CARBON BLACK, or LEAD, which are known to the state of California to cause cancer, and LEAD which is known to cause birth defects or other reproductive harm. For more information go to www.P65Warnings.ca.gov.



[Click here for CADs, Product Specifications or to Configure Parts Online](#)

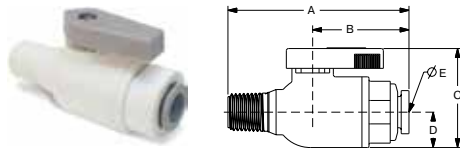
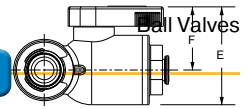

VMC - Valve Male Connector

| PART NO. | NOM. TUBE O.D. | NPTF THREAD SIZE | A | B | C | D | ØE THRU HOLE MIN. |
|-----------|----------------|------------------|------|------|-----|----|-------------------|
| LFPP4VMC2 | 1/4 | 1/8 | 2.22 | 1.21 | 1.4 | .5 | .19 |
| LFPP4VMC4 | 1/4 | 1/4 | 2.40 | 1.21 | 1.4 | .5 | .19 |
| LFPP4VMC6 | 1/4 | 3/8 | 2.40 | 1.21 | 1.4 | .5 | .19 |
| LFPP4VMC8 | 1/4 | 1/2 | 2.59 | 1.21 | 1.4 | .5 | .19 |
| LFPP6VMC2 | 3/8 | 1/8 | 2.33 | 1.32 | 1.4 | .5 | .25 |
| LFPP6VMC4 | 3/8 | 1/4 | 2.51 | 1.32 | 1.4 | .5 | .25 |
| LFPP6VMC6 | 3/8 | 3/8 | 2.51 | 1.32 | 1.4 | .5 | .25 |
| LFPP6VMC8 | 3/8 | 1/2 | 2.70 | 1.32 | 1.4 | .5 | .25 |

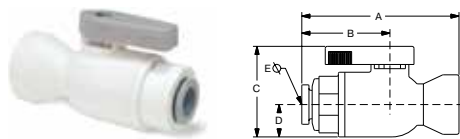

VFC - Valve Female Connector

| PART NO. | NOM. TUBE O.D. | NPTF THREAD SIZE | A | B | C | D | ØE THRU HOLE MIN. |
|-----------|----------------|------------------|------|------|-----|----|-------------------|
| LFPP4VFC2 | 1/4 | 1/8 | 2.04 | 1.21 | 1.4 | .5 | .19 |
| LFPP4VFC4 | 1/4 | 1/4 | 2.27 | 1.21 | 1.4 | .5 | .19 |
| LFPP4VFC6 | 1/4 | 3/8 | 2.40 | 1.21 | 1.4 | .5 | .19 |
| LFPP6VFC2 | 3/8 | 1/8 | 2.15 | 1.32 | 1.4 | .5 | .25 |
| LFPP6VFC4 | 3/8 | 1/4 | 2.38 | 1.32 | 1.4 | .5 | .25 |
| LFPP6VFC6 | 3/8 | 3/8 | 2.51 | 1.32 | 1.4 | .5 | .25 |

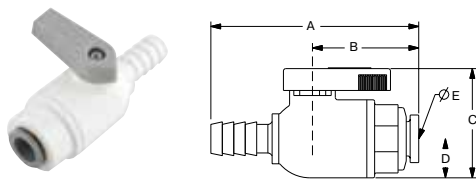

VUCPB - Valve Union Connector Barbed x Tube

| PART NO. | HOSE ID | TUBE OD | OD | A | B | C | D | ØE THRU HOLE MIN. |
|-------------|---------|---------|-----|------|------|------|-----|-------------------|
| LFPP4VUCPB4 | 1/4 | 1/4 | .31 | 2.40 | 1.08 | 1.42 | .50 | .15 |
| LFPP6VUCPB6 | 3/8 | 3/8 | .43 | 2.63 | 1.32 | 1.42 | .50 | .19 |

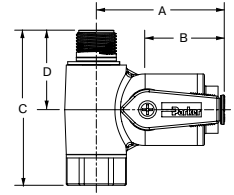

VAS - Valve Angle Stop

| PART NO. | TUBE O.D. | MALE THD. | FEMALE THD. | A | B | C | D | E | F |
|-----------|-----------|-----------|-------------|------|------|------|------|------|-----|
| LFPP4VAS6 | 1/4 | 3/8 | 3/8 | 1.95 | 1.24 | 2.17 | 1.11 | 1.41 | .91 |
| LFPP4VAS8 | 1/4 | 3/8 | 1/2 | 1.95 | 1.24 | 2.40 | 1.11 | 1.41 | .91 |
| LFPP6VAS6 | 3/8 | 3/8 | 3/8 | 2.06 | 1.35 | 2.17 | 1.11 | 1.41 | .91 |
| LFPP6VAS8 | 3/8 | 3/8 | 1/2 | 2.06 | 1.35 | 2.40 | 1.11 | 1.41 | .91 |

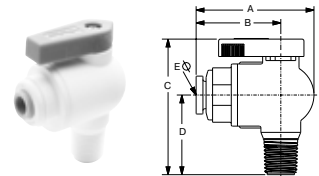

VME - Valve Male Elbow

| PART NUMBER | NOM. TUBE O.D. | NPTF THREAD SIZE | A | B | C | D | ØE THRU HOLE MIN. |
|----------------|----------------|------------------|------|------|------|------|-------------------|
| PP4VME2-MG (+) | 1/4 | 1/8 | 1.74 | 1.21 | 2.00 | 1.10 | .19 |
| PP4VME4-MG | 1/4 | 1/4 | 1.74 | 1.21 | 2.18 | 1.28 | .19 |
| PP4VME6-MG | 1/4 | 3/8 | 1.74 | 1.21 | 2.18 | 1.28 | .19 |
| PP4VME8-MG (+) | 1/4 | 1/2 | 1.74 | 1.21 | 2.37 | 1.47 | .19 |
| PP6VME2-MG (+) | 3/8 | 1/8 | 1.85 | 1.32 | 2.00 | 1.10 | .25 |
| PP6VME4-MG | 3/8 | 1/4 | 1.85 | 1.32 | 2.18 | 1.28 | .25 |
| PP6VME6-MG | 3/8 | 3/8 | 1.85 | 1.32 | 2.18 | 1.28 | .25 |
| PP6VME8-MG | 3/8 | 1/2 | 1.85 | 1.32 | 2.37 | 1.47 | .25 |

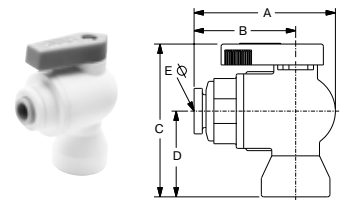

VFE - Valve Female Elbow

| PART NUMBER | NOM. TUBE O.D. | NPTF THREAD SIZE | A | B | C | D | ØE THRU HOLE MIN. |
|----------------|----------------|------------------|------|------|------|------|-------------------|
| PP4VFE2-MG (+) | 1/4 | 1/8 | 1.74 | 1.21 | 1.82 | .92 | .19 |
| PP4VFE4-MG | 1/4 | 1/4 | 1.74 | 1.21 | 2.05 | 1.15 | .19 |
| PP4VFE6-MG | 1/4 | 3/8 | 1.74 | 1.21 | 2.18 | 1.28 | .19 |
| PP6VFE2-MG (+) | 3/8 | 1/8 | 1.85 | 1.32 | 1.82 | .92 | .25 |
| PP6VFE4-MG | 3/8 | 1/4 | 1.85 | 1.32 | 2.05 | 1.15 | .25 |
| PP6VFE6-MG | 3/8 | 3/8 | 1.85 | 1.32 | 2.18 | 1.28 | .25 |

(+) Non Standard.

WARNING These products can expose you to chemicals including CARBON BLACK, or LEAD, which are known to the state of California to cause cancer, and LEAD which is known to cause birth defects or other reproductive harm. For more information go to www.P65Warnings.ca.gov.



- A
- B
- C
- D
- E
- F
- G
- H
- I
- J
- K
- L
- M
- N
- O

Click here for CADs, Product Specifications or to Configure Parts Online

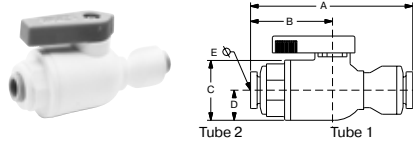

VUC - Valve Union Connector

| PART NUMBER | 1 TUBE SIZE | 2 TUBE SIZE | A | B | C | D | ØE THRU HOLE MIN. |
|-------------|-------------|-------------|------|------|-----|----|-------------------|
| PP4VUC4-MG | 1/4 | 1/4 | 2.55 | 1.22 | 1.0 | .5 | .19 |
| PP4VUC6-MG | 1/4 | 3/8 | 2.55 | 1.22 | 1.0 | .5 | .19 |
| PP6VUC4-MG | 3/8 | 1/4 | 2.57 | 1.30 | 1.0 | .5 | .19 |
| PP6VUC6-MG | 3/8 | 3/8 | 2.67 | 1.32 | 1.4 | .5 | .25 |

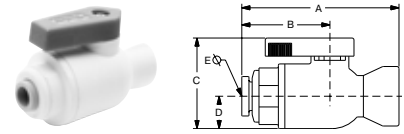

VFC - Valve Female Connector

| PART NUMBER | NOM. TUBE O.D. | NPTF THREAD SIZE | A | B | C | D | ØE THRU HOLE MIN. |
|-------------|----------------|------------------|------|------|-----|----|-------------------|
| PP4VFC2-MG | 1/4 | 1/8 | 2.04 | 1.21 | 1.4 | .5 | .19 |
| PP4VFC4-MG | 1/4 | 1/4 | 2.27 | 1.21 | 1.4 | .5 | .19 |
| PP4VFC6-MG | 1/4 | 3/8 | 2.40 | 1.21 | 1.4 | .5 | .19 |
| PP6VFC2-MG | 3/8 | 1/8 | 2.15 | 1.32 | 1.4 | .5 | .25 |
| PP6VFC4-MG | 3/8 | 1/4 | 2.38 | 1.32 | 1.4 | .5 | .25 |
| PP6VFC6-MG | 3/8 | 3/8 | 2.51 | 1.32 | 1.4 | .5 | .25 |

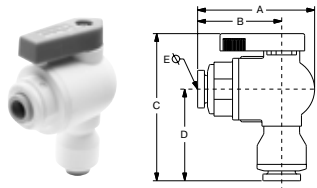

VEU - Valve Elbow Union

| PART NUMBER | 1 TUBE SIZE | 2 TUBE SIZE | A | B | C | D | ØE THRU HOLE MIN. |
|-------------|-------------|-------------|------|------|------|------|-------------------|
| PP4VEU4-MG | 1/4 | 1/4 | 1.75 | 1.22 | 2.33 | 1.42 | .19 |
| PP4VEU6-MG | 1/4 | 3/8 | 1.75 | 1.22 | 2.33 | 1.42 | .11 |
| PP6VEU4-MG | 3/8 | 1/4 | 1.83 | 1.30 | 2.32 | 1.40 | .19 |
| PP6VEU6-MG | 3/8 | 3/8 | 1.85 | 1.32 | 2.34 | 1.44 | .25 |

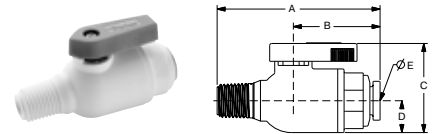

VMC - Valve Male Connector

| PART NUMBER | NOM. TUBE O.D. | NPTF THREAD SIZE | A | B | C | D | ØE THRU HOLE MIN. |
|----------------|----------------|------------------|------|------|-----|----|-------------------|
| PP4VMC2-MG (+) | 1/4 | 1/8 | 2.22 | 1.21 | 1.4 | .5 | .19 |
| PP4VMC4-MG | 1/4 | 1/4 | 2.40 | 1.21 | 1.4 | .5 | .19 |
| PP4VMC6-MG | 1/4 | 3/8 | 2.40 | 1.21 | 1.4 | .5 | .19 |
| PP4VMC8-MG (+) | 1/4 | 1/2 | 2.59 | 1.21 | 1.4 | .5 | .19 |
| PP6VMC2-MG (+) | 3/8 | 1/8 | 2.33 | 1.32 | 1.4 | .5 | .25 |
| PP6VMC4-MG | 3/8 | 1/4 | 2.51 | 1.32 | 1.4 | .5 | .25 |
| PP6VMC6-MG | 3/8 | 3/8 | 2.51 | 1.32 | 1.4 | .5 | .25 |
| PP6VMC8-MG (+) | 3/8 | 1/2 | 2.70 | 1.32 | 1.4 | .5 | .25 |

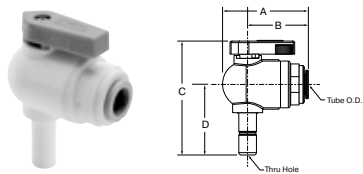

VTEU - Valve Tube Elbow Union

| PART NUMBER | NOM. TUBE O.D. | STEM | A | B | C | D | ØE THRU HOLE MIN. |
|-------------|----------------|------|------|------|------|------|-------------------|
| PP4VTEU6-MG | 1/4 | 3/8 | 1.75 | 1.22 | 2.43 | 1.50 | .17 |
| PP6VTEU6-MG | 3/8 | 3/8 | 1.83 | 1.30 | 2.43 | 1.50 | .25 |

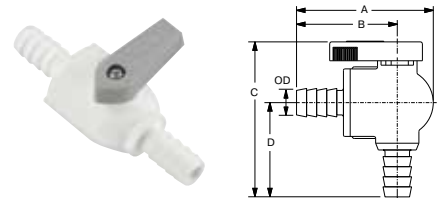

VEU - Parbarb Elbow Ball Valve

| PART NO. | HOSE I.D. | O.D. | A | B | C | D | ØE THRU HOLE MIN. |
|-----------|-----------|------|------|------|------|------|-------------------|
| PBPP4VEU4 | 1/4 | .31 | 2.13 | 1.57 | 2.32 | 1.40 | .15 |
| PBPP6VEU6 | 3/8 | .43 | 2.13 | 1.60 | 2.32 | 1.40 | .25 |
| PBPP8VEU8 | 1/2 | .55 | 2.13 | 1.60 | 2.32 | 1.40 | .25 |

WARNING These products can expose you to chemicals including CARBON BLACK, or LEAD, which are known to the state of California to cause cancer, and LEAD which is known to cause birth defects or other reproductive harm. For more information go to www.P65Warnings.ca.gov.



Click here for CADs, Product Specifications or to Configure Parts Online

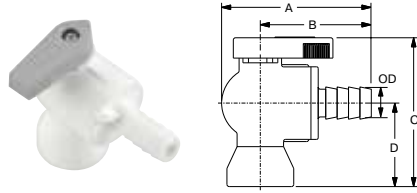

VFE - Valve Barbed Female Elbow

| PART NO. | HOSE I.D. | NPTF THD. | O.D. | A | B | C | D | ØE THRU HOLE MIN. |
|-----------|-----------|-----------|------|------|------|------|------|-------------------|
| PBPP4VFE4 | 1/4 | 1/4 | .31 | 2.13 | 1.60 | 2.05 | 1.15 | .15 |
| PBPP6VFE4 | 3/8 | 1/4 | .43 | 2.13 | 1.60 | 2.05 | 1.15 | .15 |
| PBPP6VFE6 | 3/8 | 3/8 | .43 | 2.13 | 1.60 | 2.18 | 1.28 | .19 |

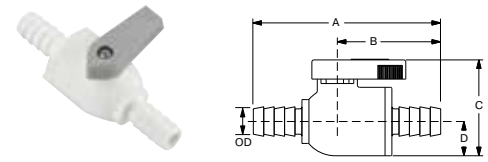

VUC - Valve Barbed Union Connector

| PART NO. | HOSE I.D. | O.D. | A | B | C | D | ØE THRU HOLE MIN. |
|-----------|-----------|------|------|------|------|-----|-------------------|
| PBPP4VUC4 | 1/4 | .31 | 2.91 | 1.60 | 1.42 | .50 | .15 |
| PBPP6VUC6 | 3/8 | .43 | 2.91 | 1.60 | 1.42 | .50 | .19 |
| PBPP8VUC8 | 1/2 | .55 | 2.91 | 1.60 | 1.42 | .50 | .25 |

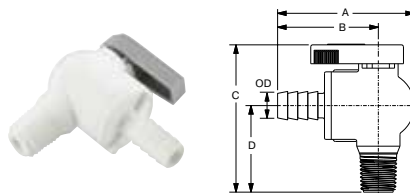

VME - Valve Barbed Male Elbow

| PART NO. | HOSE I.D. | NPTF THD. | O.D. | A | B | C | D | ØE THRU HOLE MIN. |
|-----------|-----------|-----------|------|------|------|------|------|-------------------|
| PBPP4VME4 | 1/4 | 1/4 | .31 | 2.13 | 1.60 | 2.18 | 1.28 | .15 |
| PBPP6VME6 | 3/8 | 3/8 | .43 | 2.13 | 1.60 | 2.18 | 1.28 | .19 |

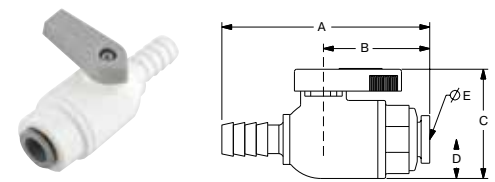

VUCPB - Valve Union Connector Barbed x Tube

| PART NO. | HOSE ID | TUBE OD | OD | A | B | C | D | ØE THRU HOLE MIN. |
|-------------|---------|---------|-----|------|------|------|-----|-------------------|
| LFPP4VUCPB4 | 1/4 | 1/4 | .31 | 2.40 | 1.08 | 1.42 | .50 | .15 |
| LFPP6VUCPB6 | 3/8 | 3/8 | .43 | 2.63 | 1.32 | 1.42 | .50 | .19 |

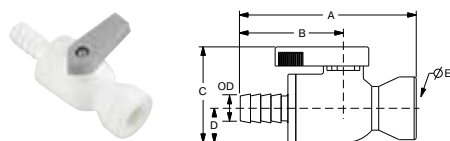

VFC - Valve Barbed Female Connector

| PART NO. | HOSE I.D. | NPTF THD. | O.D. | A | B | C | D | ØE THRU HOLE MIN. |
|-----------|-----------|-----------|------|------|------|------|-----|-------------------|
| PBPP4VFC4 | 1/4 | 1/4 | .31 | 2.76 | 1.60 | 1.41 | .50 | .15 |
| PBPP6VFC6 | 3/8 | 3/8 | .43 | 2.79 | 1.60 | 1.41 | .50 | .19 |

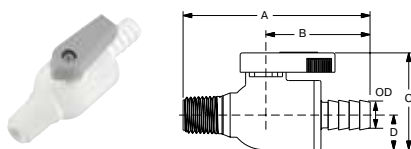

VMC - Valve Barbed Male Connector

| PART NO. | HOSE I.D. | NPTF THD. | O.D. | A | B | C | D | ØE THRU HOLE MIN. |
|-----------|-----------|-----------|------|------|------|------|-----|-------------------|
| PBPP4VMC4 | 1/4 | 1/4 | .31 | 2.79 | 1.60 | 1.42 | .50 | .15 |
| PBPP6VMC6 | 3/8 | 3/8 | .43 | 2.79 | 1.60 | 1.42 | .50 | .19 |

BVC Ball Valve Clip

BV-Clip Shown below holding VUCPB and VME

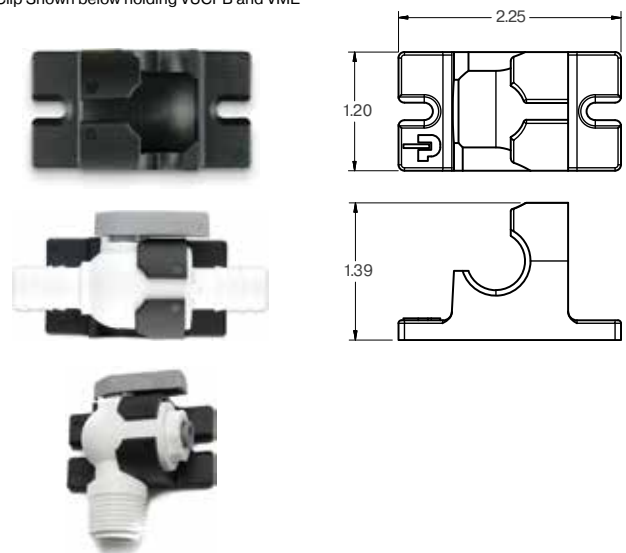

WARNING These products can expose you to chemicals including CARBON BLACK, or LEAD, which are known to the state of California to cause cancer, and LEAD which is known to cause birth defects or other reproductive harm. For more information go to www.P65Warnings.ca.gov.



[Click here for CADs, Product Specifications or to Configure Parts Online](#)

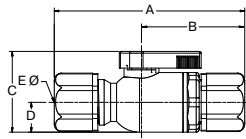

VUC - Valve Union Connector

| PART NO. | 1 TUBE SIZE | 2 TUBE SIZE | A | B | C | D | ØE THRU HOLE MIN. |
|------------|-------------|-------------|------|------|-----|----|-------------------|
| FTPPB4VUC4 | 1/4 | 1/4 | 2.94 | 1.61 | 1.4 | .5 | .19 |
| FTPPB4VUC6 | 1/4 | 3/8 | 3.07 | 1.61 | 1.4 | .5 | .19 |
| FTPPB6VUC6 | 3/8 | 3/8 | 3.19 | 1.73 | 1.4 | .5 | .25 |
| FTPPB8VUC8 | 1/2 | 1/2 | 3.27 | 1.80 | 1.4 | .5 | .38 |

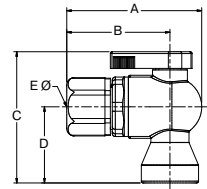

VFE - Valve Female Elbow

| PART NO. | 1 TUBE SIZE | NPTF THD SIZE | A | B | C | D | ØE THRU HOLE MIN. |
|------------|-------------|---------------|------|------|------|------|-------------------|
| FTPPB4VFE4 | 1/4 | 1/4 | 2.14 | 1.61 | 2.18 | 1.25 | .19 |
| FTPPB6VFE4 | 3/8 | 1/4 | 2.26 | 1.73 | 2.18 | 1.25 | .19 |
| FTPPB6VFE6 | 3/8 | 3/8 | 2.26 | 1.73 | 2.21 | 1.28 | .25 |
| FTPPB8VFE6 | 1/2 | 3/8 | 2.34 | 1.8 | 2.21 | 1.28 | .25 |

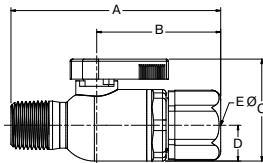

VMC - Valve Male Connector

| PART NO. | 1 TUBE SIZE | NPTF THD SIZE | A | B | C | D | ØE THRU HOLE MIN. |
|------------|-------------|---------------|------|------|-----|----|-------------------|
| FTPPB4VMC4 | 1/4 | 1/4 | 2.81 | 1.61 | 1.4 | .5 | .19 |
| FTPPB4VMC6 | 1/4 | 3/8 | 2.81 | 1.61 | 1.4 | .5 | .19 |
| FTPPB6VMC4 | 3/8 | 1/4 | 2.93 | 1.73 | 1.4 | .5 | .19 |
| FTPPB6VMC6 | 3/8 | 3/8 | 2.93 | 1.73 | 1.4 | .5 | .25 |
| FTPPB8VMC6 | 1/2 | 3/8 | 3.00 | 1.79 | 1.4 | .5 | .25 |

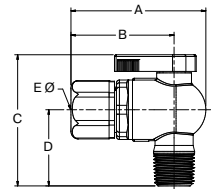

VME - Valve Male Elbow

| PART NO. | 1 TUBE SIZE | NPTF THD SIZE | A | B | C | D | ØE THRU HOLE MIN. |
|------------|-------------|---------------|------|------|------|------|-------------------|
| FTPPB4VME4 | 1/4 | 1/4 | 2.14 | 1.61 | 2.21 | 1.28 | .19 |
| FTPPB6VME4 | 3/8 | 1/4 | 2.26 | 1.73 | 2.21 | 1.28 | .19 |
| FTPPB6VME6 | 3/8 | 3/8 | 2.26 | 1.73 | 2.21 | 1.28 | .25 |
| FTPPB8VME8 | 1/2 | 1/2 | 2.34 | 1.8 | 2.4 | 1.47 | .38 |

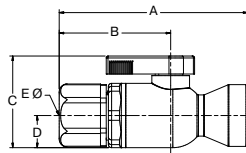

VFC - Valve Female Connector

| PART NO. | 1 TUBE SIZE | NPTF THD SIZE | A | B | C | D | ØE THRU HOLE MIN. |
|------------|-------------|---------------|------|------|-----|----|-------------------|
| FTPPB4VFC4 | 1/4 | 1/4 | 2.78 | 1.61 | 1.4 | .5 | .19 |
| FTPPB6VFC6 | 3/8 | 3/8 | 2.93 | 1.73 | 1.4 | .5 | .25 |
| FTPPB8VFC6 | 1/2 | 3/8 | 3.00 | 1.8 | 1.4 | .5 | .25 |

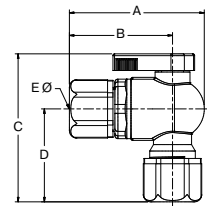

VEU - Valve Elbow Union

| PART NO. | 1 TUBE SIZE | 2 TUBE SIZE | A | B | C | D | ØE THRU HOLE MIN. |
|------------|-------------|-------------|------|------|------|------|-------------------|
| FTPPB4VEU4 | 1/4 | 1/4 | 2.14 | 1.61 | 2.35 | 1.42 | .19 |
| FTPPB6VEU4 | 3/8 | 1/4 | 2.26 | 1.73 | 2.37 | 1.44 | .19 |
| FTPPB6VEU6 | 3/8 | 3/8 | 2.26 | 1.73 | 2.49 | 1.56 | .25 |
| FTPPB8VEU8 | 1/2 | 1/2 | 2.34 | 1.8 | 2.47 | 1.54 | .38 |

WARNING These products can expose you to chemicals including CARBON BLACK, or LEAD, which are known to the state of California to cause cancer, and LEAD which is known to cause birth defects or other reproductive harm. For more information go to www.P65Warnings.ca.gov.





Plug Valves Series PV

Product Features:

- Extruded Brass Body
- One Piece Stem/Handle
- Acetal Stem/Handle
- 100% Leak Tested

Style:

- PV-Plug Valve

Type:

- 607-Male/Male
- 608-Male/Female
- 609-Female/Female

Specifications:

Pressure Range:

- Up to 250 PSI (17.2 bar)

Temperature Range

- -40° to +175° F (-40° to +79.4° C)

Valve Components

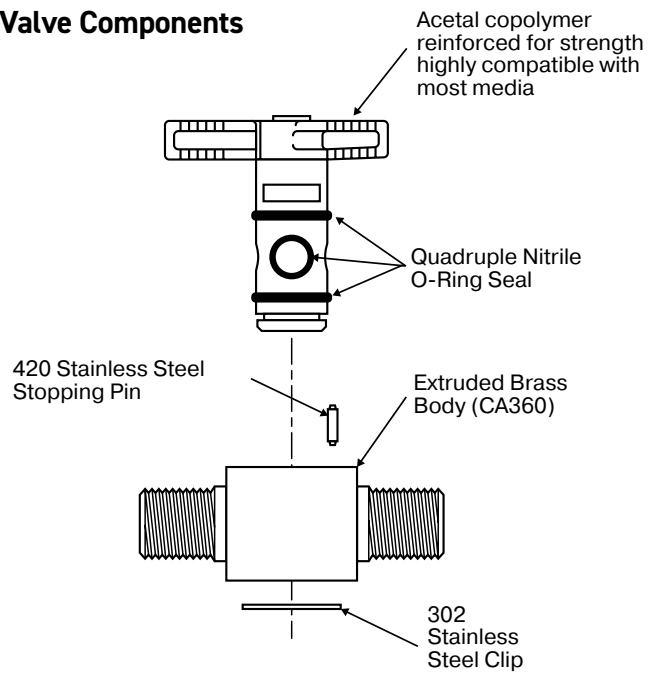

Assembly Instructions

To assure sealability and reliable performance, the valve must be installed so that the flow media travels in the direction of the arrow on the valve handle.



WARNING These products can expose you to chemicals including NICKEL or LEAD, which are known to the state of California to cause cancer, and LEAD which is known to cause birth defects or other reproductive harm. For more information go to www.P65Warnings.ca.gov.



Click here for CADs, Product Specifications or to Configure Parts Online

- A
- B
- C
- D
- E
- F
- G
- H
- I
- J
- K
- L
- M
- N
- O

Male Pipe to Male Pipe Plug Valve PV607

| PART NO. | PIPE THREAD | H | L | M | N | N1 | FLOW DIA. D |
|----------|-------------|-----|------|------|------|-----|-------------|
| PV607-2 | 1/8 | .67 | 1.34 | 1.66 | 1.38 | .51 | .200 |
| PV607-4 | 1/4 | .67 | 1.34 | 2.02 | 1.38 | .51 | .200 |

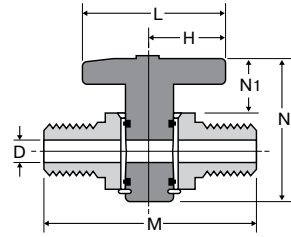

Female Pipe to Male Pipe Plug Valve PV608

| PART NO. | PIPE THREAD | H | L | M | N | N1 | FLOW DIA. D |
|----------|-------------|-----|------|------|------|-----|-------------|
| PV608-2 | 1/8 | .67 | 1.34 | 1.67 | 1.38 | .51 | .200 |
| PV608-4 | 1/4 | .67 | 1.34 | 2.06 | 1.38 | .51 | .200 |

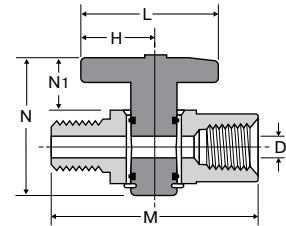

Female Pipe to Female Pipe Plug Valve PV609

| PART NO. | PIPE THREAD | H | L | M | N | N1 | FLOW DIA. D |
|----------|-------------|-----|------|------|------|-----|-------------|
| PV609-2 | 1/8 | .67 | 1.34 | 1.68 | 1.38 | .51 | .200 |
| PV609-4 | 1/4 | .67 | 1.34 | 2.10 | 1.38 | .51 | .200 |

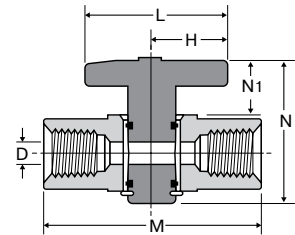

Mounting Bracket PVMB-001

| PART NO. | H | M | N | N1 | D |
|----------|-----|------|-----|-----|------|
| PVMB-001 | .68 | 1.86 | .90 | .45 | .135 |

Note: 1" diameter hole required in panel when using mounting bracket

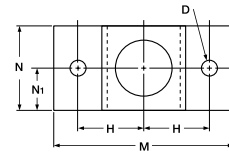

WARNING These products can expose you to chemicals including NICKEL or LEAD, which are known to the state of California to cause cancer, and LEAD which is known to cause birth defects or other reproductive harm. For more information go to www.P65Warnings.ca.gov.



Ball Valves Rotary Actuator Series ACT



Product Features:

- One Piece Aluminum Extrusion Body
- PTFE Seals
- Stainless Steel Shaft
- Self Lubricated Vane Seal
- Anodized Aluminum Extrusion Vane

Specifications:

Pressure Range:

- 150 PSI (10.3 bar)
Maximum Air Pressure to Actuator
- Vacuum service 28 inches Hg

Temperature Range

- -40° to +180° F (-40° to +82.2° C)

How Do Vane Actuators Work?

Parker vane actuators provide the maximum amount of output torque from the smallest possible envelope size. They convert fluid power pressure into rotary motion for a wide variety of industrial applications. Double vane units produce twice the torque output of single vane actuators from identical envelope dimensions and have a maximum rotation of 95°.

A short cylindrical chamber encloses a vane attached to a central shaft. Fluid pressure differential is applied through a stationary barrier (stator) within the cylinder to one side of the vane. The opposite side of the vane is connected to exhaust through the stator. This pressure differential produces rotation of the vane and central shaft. Due to vane actuator design there will always be some internal bypass in these units.

Rotary Actuator Series ACT Features (See figure 1, next page)

- 1. Heads** - are precision machined from aluminum, then hard-coat anodized and PTFE impregnated to ensure long seal life and low breakaway pressure.
- 2. Body** - is machined from a one-piece aluminum extrusion that incorporates the stator for superior rigidity. The extrusion is hard-coat anodized and PTFE impregnated, resulting in a smooth, slick seal surface which guarantees long seal life and low breakaway pressure.
- 3. Shoulder Seal** - a nitrile-energized, PTFE seal is used to reduce bypass flow and friction, providing superior performance and long life.
- 4. Shaft Seal** - the high-quality, self-lubricated, abrasion-resistant nitrile seal is a multiple lobe construction for leakfree operation and greater reliability.
- 5. Shaft** - stainless steel provides high strength and corrosion resistance for the most demanding applications.
- 6. Bearings** - hard-coat anodized aluminum-bearing surface with permanent solid film lubricant provides substantial shaft support and wear resistance, ensuring continuous lubrication, high performance, and long life.
- 7. Mounting** - combination face and base mounting offer flexibility in application and design.
- 8. Vane Seal** - a special self-lubricated, abrasion-resistant nitrile compound is molded into a one-piece vane seal, providing low breakaway pressure and long life, even with no lubrication. The vane seal is also removable so that field repairs can be made, if necessary.
- 9. Vane** - a hard-coat anodized aluminum extrusion permanently affixed to shaft, forming a structurally sound assembly. The light weight also reduces inertia allowing faster operating speeds.

WARNING These products can expose you to chemicals including NICKEL or LEAD, which are known to the state of California to cause cancer, and LEAD which is known to cause birth defects or other reproductive harm. For more information go to www.P65Warnings.ca.gov.



A

B

C

D

E

F

G

H

I

J

K

L

M

N

O

[Click here for CADs, Product Specifications or to Configure Parts Online](#)

- A
- B
- C
- D
- E
- F
- G
- H
- I
- J
- K
- L
- M
- N
- O

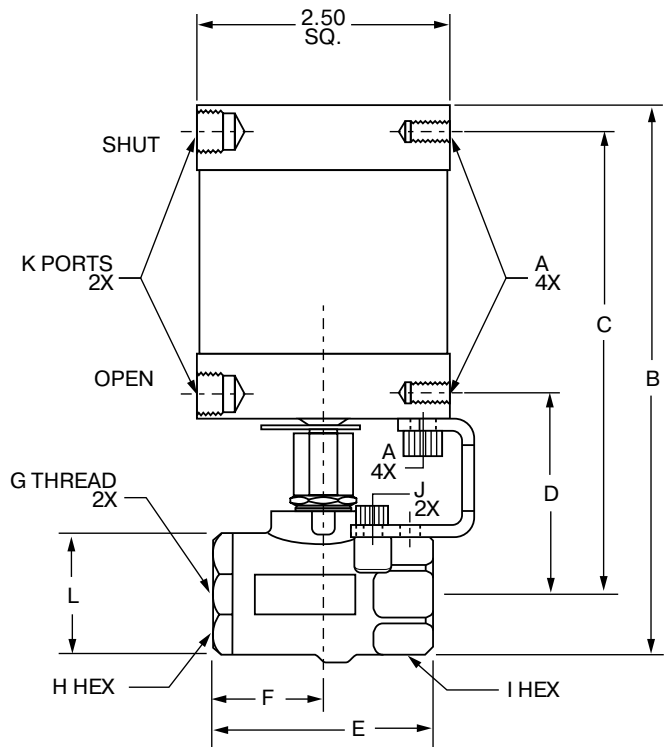
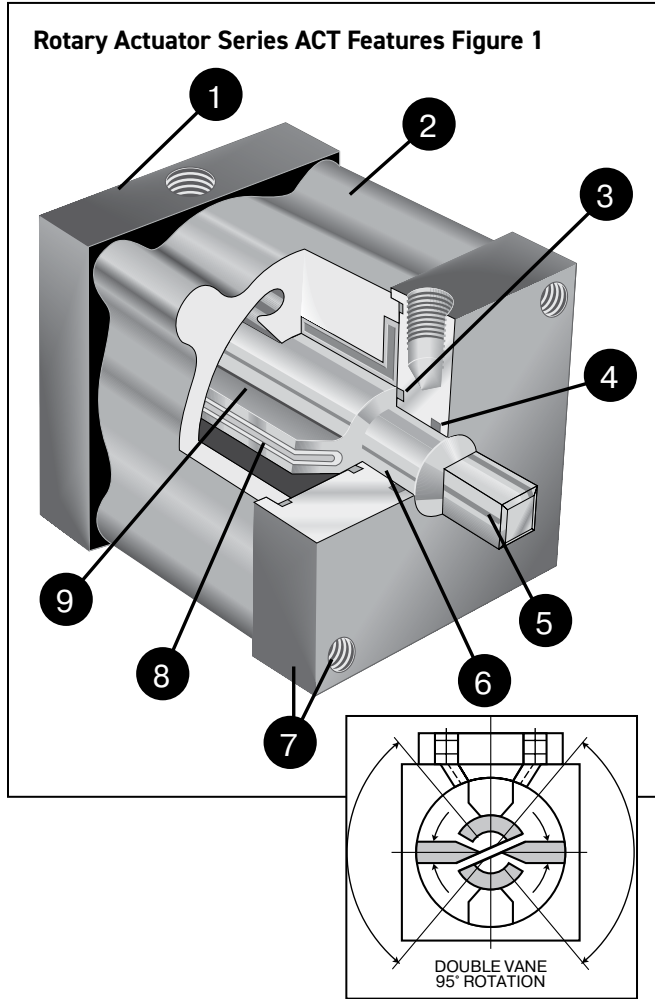

Rotary Actuator, Female Pipe Ends V502P-X-ACT

| PART NO. | SIZE | A MTG. HOLES | B | C | D | E | F | G | H HEX | I HEX | J UNC | K NPTF | L | FLOW DIA. | FLOW CV | MIN. ACT PRESSURE (PSI) |
|--------------|------|--------------|------|------|------|------|------|-------------|--------|--------|-------|--------|------|-----------|---------|-------------------------|
| V502P-4-ACT | 1/4 | 1/4-20 UNC | 5.25 | 4.47 | 1.91 | 2.03 | 1.00 | 1/4-18PTF | 15/16 | 15/16 | 10-24 | 1/8-27 | 1.06 | .375 | 4.0 | 50 |
| V502P-6-ACT | 3/8 | 1/4-20 UNC | 5.25 | 4.47 | 1.91 | 2.03 | 1.00 | 3/8-18PTF | 15/16 | 15/16 | 10-24 | 1/8-27 | 1.06 | .375 | 5.8 | 50 |
| V502P-8-ACT | 1/2 | 1/4-20 UNC | 5.38 | 4.54 | 1.98 | 2.20 | 1.09 | 1/2-14PTF* | 1-1/16 | 1-1/16 | 10-24 | 1/8-27 | 1.19 | .500 | 12.0 | 50 |
| V502P-12-ACT | 3/4 | 1/4-20 UNC | 5.57 | 4.63 | 2.07 | 2.42 | 1.29 | 3/4-14PTF** | 1-5/16 | 1-1/4 | 10-24 | 1/8-27 | 1.38 | .685 | 25.0 | 75 |
| V502P-16-ACT | 1 | 1/4-20 UNC | 5.85 | 4.76 | 2.20 | 2.75 | 1.38 | 1-11.5PTF** | 1-9/16 | 1-1/2 | 10-24 | 1/8-27 | 1.67 | .875 | 35.0 | 75 |

Stainless Steel Rotary Actuator, Female Pipe Ends V502SS-X-ACT

| PART NO. | SIZE | A MTG. HOLES | B | C | D | E | F | G | H/I HEX | J | K NPTF | L | FLOW DIA. | FLOW CV |
|--------------|------|--------------|------|------|------|------|------|------------|---------|-------|--------|------|-----------|---------|
| V502SS-4-ACT | 1/4 | 1/4-20 UNC | 5.41 | 4.61 | 2.05 | 2.07 | 1.04 | 1/4-18 NPT | 15/16 | 10-24 | 1/8-27 | 1.10 | .375 | 4.0 |
| V502SS-6-ACT | 3/8 | 1/4-20 UNC | 5.41 | 4.61 | 2.05 | 2.07 | 1.04 | 3/8-18 NPT | 15/16 | 10-24 | 1/8-27 | 1.10 | .375 | 6.0 |
| V502SS-8-ACT | 1/2 | 1/4-20 UNC | 5.53 | 4.64 | 2.08 | 2.27 | 1.17 | 1/2-14 NPT | 1 1/16 | 10-24 | 1/8-27 | 1.28 | .500 | 14.0 |

*Ptf Special Short. **Ptf Special Extra Short

WARNING These products can expose you to chemicals including NICKEL or LEAD, which are known to the state of California to cause cancer, and LEAD which is known to cause birth defects or other reproductive harm. For more information go to www.P65Warnings.ca.gov.



Click here for CADs, Product Specifications or to Configure Parts Online

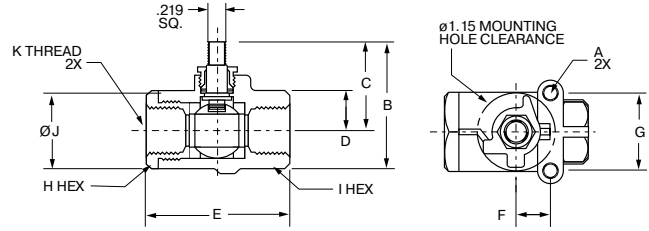

Actuator Sub-Assembly V502P-X-SUB

| PART NO | SIZE | A UNC | B | C | D | E | F | G | H HEX | I HEX | J | K |
|--------------|------|-------|------|------|------|------|-----|------|--------|--------|------|--------------|
| V502P-4-SUB | 1/4 | 10-24 | 1.68 | 1.15 | .495 | 2.03 | .50 | 1.12 | 15/16 | 15/16 | 1.06 | 1/4-18 PTF |
| V502P-6-SUB | 3/8 | 10-24 | 1.68 | 1.15 | .495 | 2.03 | .50 | 1.12 | 15/16 | 15/16 | 1.06 | 3/8-18 PTF |
| V502P-8-SUB | 1/2 | 10-24 | 1.78 | 1.19 | .565 | 2.20 | .50 | 1.12 | 1-1/16 | 1-1/16 | 1.19 | 1/2-14 PTF* |
| V502P-12-SUB | 3/4 | 10-24 | 2.09 | 1.40 | .655 | 2.42 | .87 | 1.37 | 1-5/16 | 1-1/4 | 1.38 | 3/4-14 PTF** |
| V502P-16-SUB | 1 | 10-24 | 2.38 | 1.54 | .785 | 2.75 | .87 | 1.37 | 1-9/16 | 1-1/2 | 1.67 | 1-11.5 PTF** |

* PTF Special Short
 ** PTF Special Extra Short

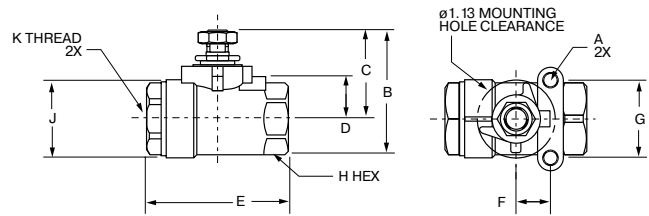

Actuator Sub-Assembly V502SS-X-SUB

| PART NO | SIZE | A UNC | B | C | D | E | F | G | H HEX | J | K |
|--------------|------|-------|------|------|-----|------|-----|------|--------|------|------------|
| V502SS-4-SUB | 1/4 | 10-24 | 1.88 | 1.32 | .63 | 2.07 | .50 | 1.12 | 15/16 | 1.10 | 1/4-18 NPT |
| V502SS-6-SUB | 3/8 | 10-24 | 1.88 | 1.32 | .63 | 2.07 | .50 | 1.12 | 15/16 | 1.10 | 3/8-18 NPT |
| V502SS-8-SUB | 1/2 | 10-24 | 2.00 | 1.35 | .66 | 2.27 | .50 | 1.12 | 1-1/16 | 1.28 | 1/2-14 NPT |

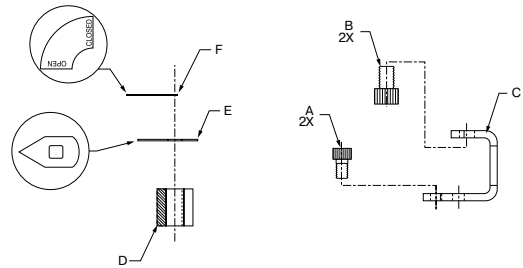

ACT-P-X-KIT

| PART NO. | FOR USE WITH | A | B | C | D | E | F |
|-------------|-------------------|-----------|------------|---------|-------------------|--------------------|----------------|
| ACT-P-1-KIT | V502P-4, 6, 8-ACT | 10-24 UNC | 1/4-20 UNC | BRACKET | .60 LONG COUPLING | POSITION INDICATOR | POSITION LABEL |
| ACT-P-2-KIT | V502P-12, 16-ACT | 10-24 UNC | 1/4-20 UNC | BRACKET | .55 LONG COUPLING | POSITION INDICATOR | POSITION LABEL |

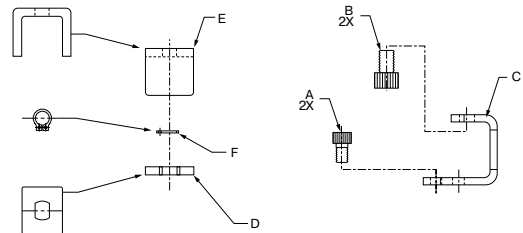

ACT-SS-X-KIT

| PART NO. | FOR USE WITH | A | B | C | D | E | F |
|--------------|--------------------|-----------|------------|---------|------|-------------|-----------|
| ACT-SS-1-KIT | V502SS-4, 6, 8-ACT | 10-24 UNC | 1/4-20 UNC | BRACKET | CLIP | HANDLE YOKE | SNAP RING |

WARNING These products can expose you to chemicals including NICKEL or LEAD, which are known to the state of California to cause cancer, and LEAD which is known to cause birth defects or other reproductive harm. For more information go to www.P65Warnings.ca.gov.



A

B

C

D

E

F

G

H

I

J

K

L

M

N

O

Ball Valve Series BVGL



Product Features:

- Nickel plated brass body
- Chrome plated brass ball
- PTFE seats/seals
- Fluorocarbon stem seal

Specifications:

- Female threads manufactured in accordance to DIN 2999/ISO 228

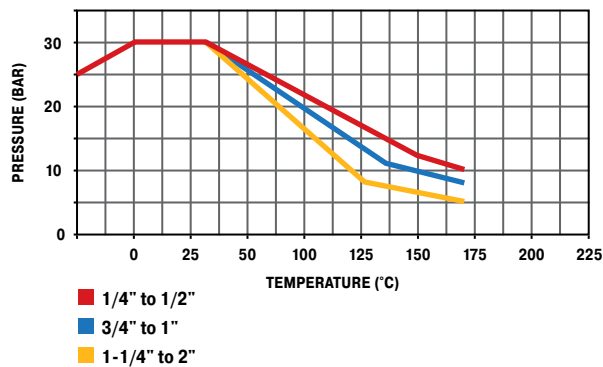

Advantages

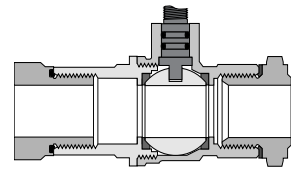
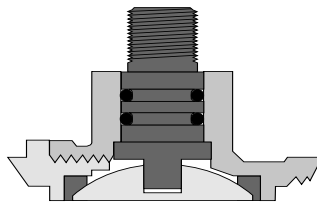
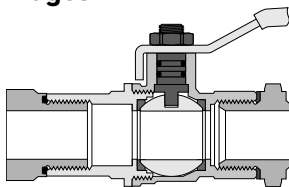

Long female threads

BVGL series valves are manufactured with long female threads in accordance to DIN 2999/ISO 228. This enables the valves to be used with Prestolok and brass adaptors but also Parker's range of steel hydraulic fittings, e.g. Triple-Lok, O-Lok, EO, and BSPP coned adaptors.

Anti extrusion stem

The BVGL series ball valves are fitted with an anti extrusion stem to prevent blow out in the case of pressure peaks. The stem is sealed with two Fluorocarbon O-rings for maximum safety and performance.

Full flow

All BVGL series valves are full-flow. This limits the turbulence created by the passage of fluid across the valve, minimizing pressure drop.

WARNING These products can expose you to chemicals including NICKEL or LEAD, which are known to the state of California to cause cancer, and LEAD which is known to cause birth defects or other reproductive harm. For more information go to www.P65Warnings.ca.gov.



BVGL BSPP Female/Female Valve with Lever Handle

| PART NO. | DN MM | THREAD BSPP | C | H | L | L1 | O |
|-------------|-------|-------------|----|----|-----|-----|------|
| BVG4-1/4L | 8 | 1/4 | 20 | 38 | 50 | 82 | 25.0 |
| BVG4-3/8L | 10 | 3/8 | 20 | 38 | 60 | 82 | 25.0 |
| BVG4-1/2L | 15 | 1/2 | 25 | 43 | 75 | 100 | 32.5 |
| BVG4-3/4L | 20 | 3/4 | 32 | 50 | 80 | 120 | 39.0 |
| BVG4-1L | 25 | 1 | 41 | 54 | 90 | 120 | 47.5 |
| BVG4-1.1/4L | 32 | 1 1/4 | 50 | 73 | 110 | 158 | 59.0 |
| BVG4-1.1/2L | 40 | 1 1/2 | 55 | 79 | 120 | 158 | 71.5 |
| BVG4-2L | 50 | 2 | 70 | 86 | 140 | 158 | 86.0 |

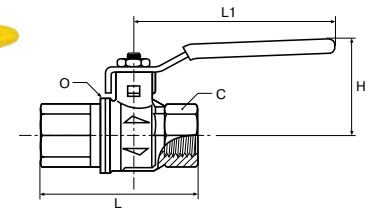

BVGT4 BSPP Female/Female Valve with Compact Handle

| PART NO. | DN MM | THREAD BSPP | C | H | L | L1 | O |
|------------|-------|-------------|----|----|----|----|------|
| BVGT4-1/4L | 8 | 1/4 | 20 | 39 | 50 | 50 | 25.0 |
| BVGT4-3/8L | 10 | 3/8 | 20 | 39 | 60 | 50 | 25.0 |
| BVGT4-1/2L | 15 | 1/2 | 25 | 43 | 75 | 50 | 32.5 |
| BVGT4-3/4L | 20 | 3/4 | 32 | 47 | 80 | 60 | 39.0 |
| BVGT4-1L | 25 | 1 | 41 | 51 | 90 | 60 | 47.5 |

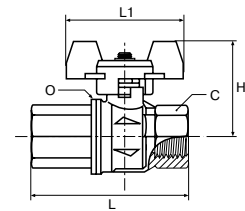

A

B

C

D

E

F

G

H

I

J

K

L

M

N

O

WARNING These products can expose you to chemicals including NICKEL or LEAD, which are known to the state of California to cause cancer, and LEAD which is known to cause birth defects or other reproductive harm. For more information go to www.P65Warnings.ca.gov.



A
B
C
D
E
F
G
H
I
J
K
L
M
N
O

Ball Valve Series BVGLOCK



Product Features:

- Nickel plated brass body
- Chrome plated brass ball
- PTFE seats /seals
- PTFE packing gland
- Carbon steel handle

Specifications:

- Meets the requirements of European directive DI 89/392/CEE relating to the isolation of power supply and to meet the health and safety requirements for machines and materials in paragraphs L233-5 of the code DU Travail.

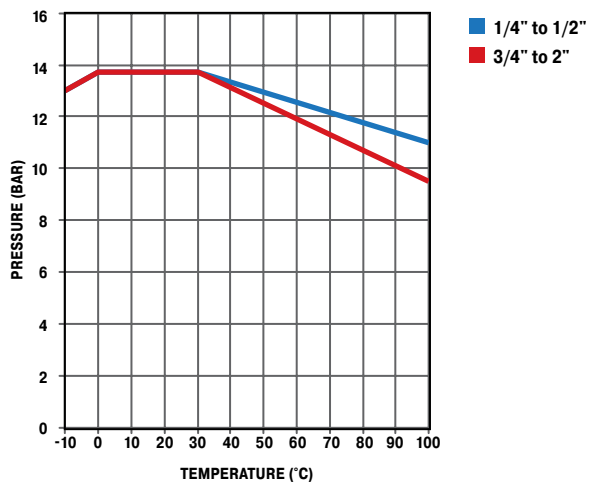

WARNING These products can expose you to chemicals including NICKEL or LEAD, which are known to the state of California to cause cancer, and LEAD which is known to cause birth defects or other reproductive harm. For more information go to www.P65Warnings.ca.gov.



Advantages

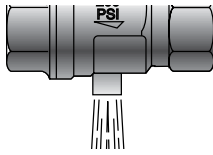

Threaded Exhaust

BVGLOCK series ball valves are manufactured with an exhaust port, this safety feature enables the downstream air pressure to be vented when the valve is closed. 1/4-1" have M5 thread. 1.1/4 and larger are not threaded.

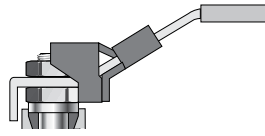

Lockable Handle

The BVGLOCK series ball valves are fitted with a handle that can be locked in the closed position with a padlock. This safety feature ensures the valve cannot be accidentally opened, and only authorized personnel can operate the valve.

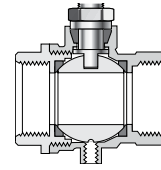

DIN 2999 / ISO 228 Female Threads

BVGLOCK series valves are manufactured with long female threads in accordance to DIN2999/ISO228. This enables the valves to be used with Prestolok and brass adaptors but also Parker's range of steel hydraulic fittings and EO-fittings form "A" or "C" to DIN 3852.

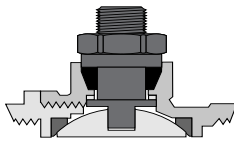

Anti Extrusion Stem

The BVGLOCK series ball valves are fitted with an anti-extrusion stem to prevent blow out in the case of pressure peaks.

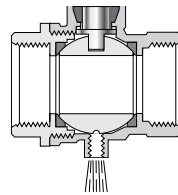

Full Flow

All BVGLOCK series valves are full-flow. This limits the turbulence created by the passage of fluid across the valve, minimizing pressure drop.

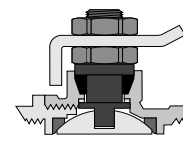

Adjustable Packing

The PTFE packing gland and adjustable washer are designed to give longer service like and lower operating torques.

BVG4PLOCK BSSP Female/Female, Vented, Locking Handle

| PART NO. | D FLOW Ø | THREAD BSSP | C | G | H | I | L | L1 | N |
|-----------------|----------|-------------|----|------|------|------|-----|-----|------|
| BVG4P-1/4 LOCK | 8.0 | 1/4 | 20 | 22.5 | 47.5 | 12.0 | 45 | 96 | M5 |
| BVG4P-3/8 LOCK | 9.5 | 3/8 | 20 | 22.5 | 47.5 | 12.0 | 45 | 96 | |
| BVG4P-1/2 LOCK | 15.0 | 1/2 | 25 | 29.5 | 52.0 | 15.5 | 59 | 96 | |
| BVG4P-3/4 LOCK | 19.0 | 3/4 | 31 | 32.0 | 59.5 | 17.0 | 64 | 117 | |
| BVG4P-1 LOCK | 24.0 | 1 | 40 | 40.5 | 63.5 | 21.0 | 81 | 117 | |
| BVG4P-1.1/4LOCK | 32.0 | 1-1/4 | 49 | 46.5 | 76.5 | 23.0 | 93 | 158 | G1/4 |
| BVG4P-1.1/2LOCK | 40.0 | 1-1/2 | 54 | 51.0 | 82.5 | 23.0 | 102 | 158 | |
| BVG4P-2LOCK | 50.0 | 2 | 69 | 60.5 | 89.5 | 26.5 | 121 | 158 | |

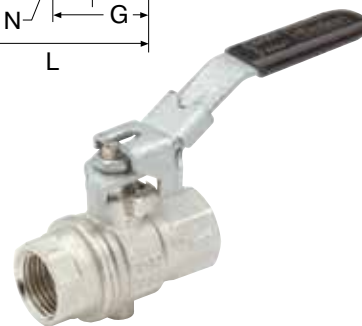
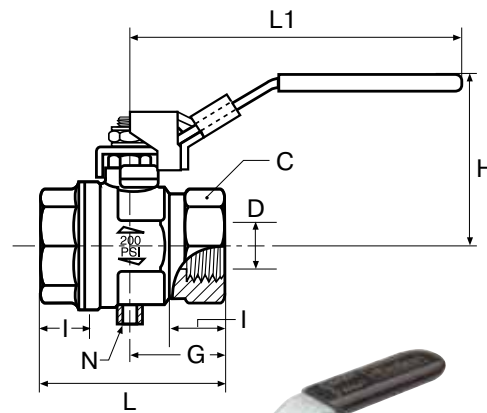

WARNING These products can expose you to chemicals including NICKEL or LEAD, which are known to the state of California to cause cancer, and LEAD which is known to cause birth defects or other reproductive harm. For more information go to www.P65Warnings.ca.gov.



- A
- B
- C
- D
- E
- F
- G
- H
- I
- J
- K
- L
- M
- N
- O

A

B

C

D

E

F

G

H

I

J

K

L

M

N

O

Axial Valves



Parker's Axial Valve incorporates both the valve and actuation function. With pneumatic or electro-pneumatic control, it avoids many of the restrictions associated with traditional actuators.

Product Features:

- Compact, up to 50% smaller than valves with separate actuators
- Simple to install
- Common sub-base for solenoid control
- Automation of the open/close function
- Operation independent of the upstream and downstream pressure in the circuit

Applications:

- Injection Molding
- Pneumatics
- Packaging
- Textile
- Printing
- Robotics

Specifications:

Pressure Range:

- Up to 150 PSI (10.3 bar)

Vacuum Service:

- 29 in Hg

Pilot Pressure:

- NC: 60 to 115 PSI (4.1 to 7.9 bar)

Temperature Range:

- -4° to +275° F (-20° to +135° C)

Water at ambient temperature under a 1 bar differential pressure.

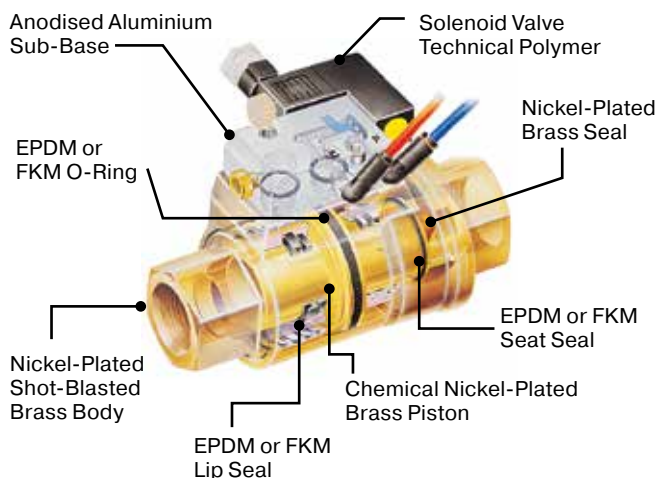
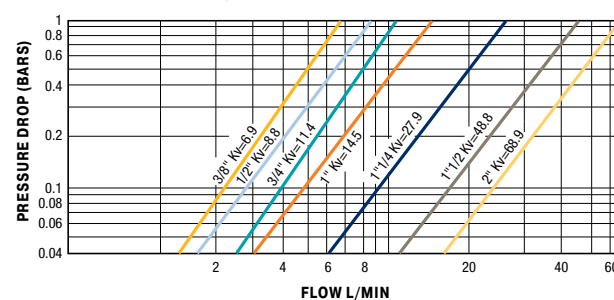

WARNING These products can expose you to chemicals including NICKEL or LEAD, which are known to the state of California to cause cancer, and LEAD which is known to cause birth defects or other reproductive harm. For more information go to www.P65Warnings.ca.gov.



Operation

Depending on operational requirement, air is passed into the actuation chamber to open or close the valve.

Normally Closed Axial Valve (NC)

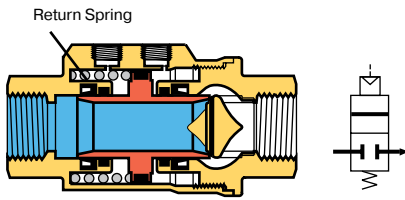

Rest State (Valve Closed)

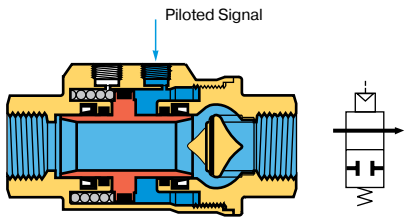

Piloted State (Valve Open)

Normally Open Axial Valve (NO)

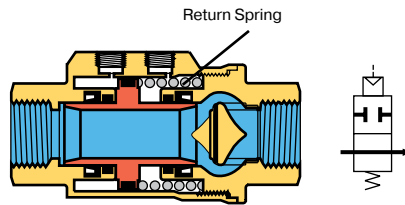

Rest State (Valve Open)

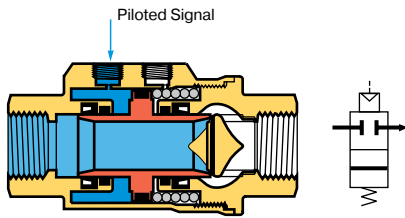

Piloted State (Valve Closed)

Double-Acting Axial Valve (DE)

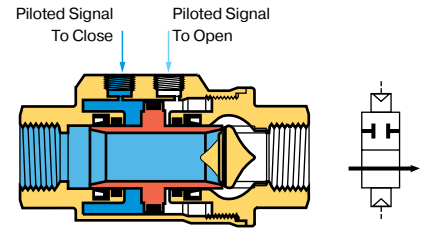

Piloted State (Valve Closed)

Installation Options

The Parker axial valve offers 3 different control methods dependant on the requirements of the installation:

Pneumatic Control

Example: Double-acting axial valve 4222

- Local compressed air control
- For repetitive on/off cycles
- Remote control where access to the machine is difficult
- For explosive or explosion prevention areas

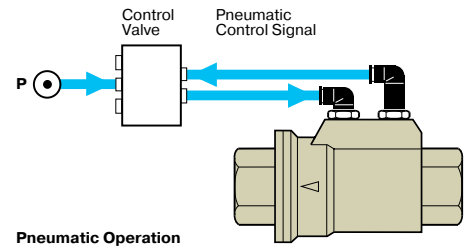

Electro-Pneumatic Control

Example: Normally closed axial valve 4202

- Sub-base and mini-solenoid valve 4298
- For automated industrial systems requiring remote control
- Namur seating plane solenoid valve

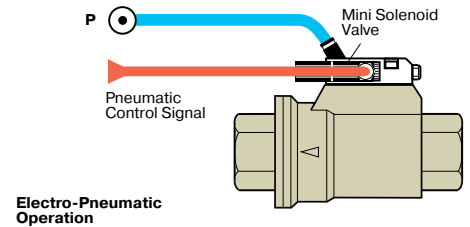

Dual Pneumatic and Electro-Pneumatic Control

Example: Normally open axial valve 4212

- Sub-base and mini-solenoid valve 4298
- Pneumatic push-button 4299
- Dual control structure
- For increased safety: prevents localised operating errors
- Namur seating plane solenoid valve

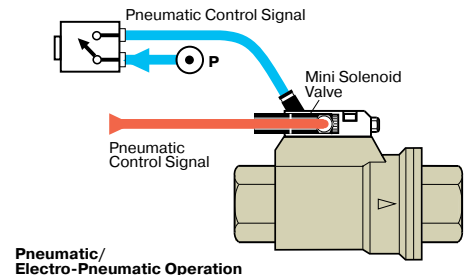

WARNING These products can expose you to chemicals including NICKEL or LEAD, which are known to the state of California to cause cancer, and LEAD which is known to cause birth defects or other reproductive harm. For more information go to www.P65Warnings.ca.gov.



- A
- B
- C
- D
- E
- F
- G
- H
- I
- J
- K
- L
- M
- N
- O

4203 Normally Closed, Double Female – NPT

| PART NO. | C NPT | DN | F MM | G IN | H IN | H1 IN | L IN | LB. |
|---------------|-------|----|------|------|------|-------|------|-------|
| 4203 10 18 20 | 3/8 | 10 | 22 | 1.81 | 2.12 | 1.21 | 3.60 | 1.79 |
| 4203 15 22 20 | 1/2 | 15 | 27 | 2.03 | 2.33 | 1.31 | 4.13 | 2.39 |
| 4203 20 28 20 | 3/4 | 20 | 33 | 2.50 | 2.76 | 1.51 | 4.92 | 3.60 |
| 4203 40 50 20 | 1 1/2 | 40 | 60 | 3.78 | 4.01 | 2.12 | 6.67 | 9.22 |
| 4203 50 44 20 | 2 | 50 | 75 | 4.29 | 4.50 | 2.35 | 7.39 | 14.02 |

Pilot port: 1/8" - 27 NPT Complete with 1/8 NPT silencer

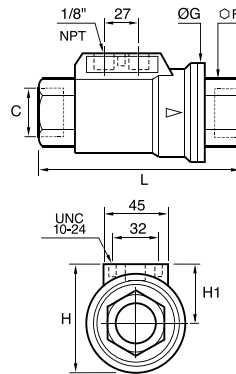

4202 Normally Closed, Double Female – BSPP

| PART NO. | C BSPP | DN | F MM | G IN | H IN | H1 IN | L IN | KG. |
|---------------|--------|----|------|------|------|-------|------|-------|
| 4202 10 17 20 | G3/8 | 10 | 22 | 46 | 54 | 31 | 98 | .814 |
| 4202 15 21 20 | G1/2 | 15 | 27 | 52 | 60 | 35 | 112 | 1.085 |
| 4202 20 27 20 | G3/4 | 20 | 33 | 64 | 70 | 38 | 135 | 1.634 |
| 4202 25 34 20 | G1 | 25 | 41 | 69 | 76 | 41.5 | 143 | 2.024 |
| 4202 32 42 20 | G1 1/4 | 32 | 50 | 86 | 91 | 48 | 165 | 3.301 |
| 4202 40 49 20 | G1 1/2 | 40 | 60 | 96 | 102 | 54 | 180 | 4.180 |
| 4202 50 48 20 | G2 | 50 | 75 | 109 | 115 | 60.5 | 207 | 6.360 |

Pilot port: 1/8 BSPP Complete with 1/8 BSPT silencer

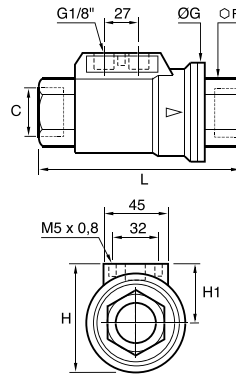

WARNING These products can expose you to chemicals including NICKEL or LEAD, which are known to the state of California to cause cancer, and LEAD which is known to cause birth defects or other reproductive harm. For more information go to www.P65Warnings.ca.gov.



Replacement Handles

| | VALVE | PLATED STEEL LEVER W/COVER | S.S. LEVER (NO COVER) | S.S. LEVER W/COVER | TEE (NO COVER) | OVAL (W/COVER) | SHORT LEVER (NO COVER) | PLATED STEEL LKG. LEVER W/COVER | S.S. LOCKING LEVER W/COVER |
|---|------------|----------------------------|-----------------------|--------------------|----------------|----------------|------------------------|---------------------------------|----------------------------|
| V500P (501, 502, 506, 510, 590, 591) | -4 | 2560-10082 | 2566-00105 | | 2566-00147 | 2566-00215 | 2566-00231 | 2560-10080 | 2560-10081 |
| | -6 | 2560-10082 | 2566-00105 | | 2566-00147 | 2566-00215 | 2566-00231 | 2560-10080 | 2560-10081 |
| | -8 | 2560-10082 | 2566-00105 | | 2566-00147 | 2566-00215 | 2566-00231 | 2560-10080 | 2560-10081 |
| | -10 | 2560-10097 | 2566-00178 | | 2566-00179 | | | 2560-10100 | |
| | -12 | 2560-10097 | 2566-00178 | | 2566-00179 | 2566-00180 | — | 2560-10100 | 2560-10101 |
| | -16 | 2560-10097 | 2566-00178 | | 2566-00179 | 2566-00180 | — | 2560-10100 | 2560-10101 |
| | -20 | 2566-00143 | 2566-00153 | | | — | 2566-00142 | 2566-00135 | — |
| | -24 | 2566-00143 | 2566-00153 | | | — | 2566-00142 | 2566-00135 | — |
| | -32 | 2566-00143 | 2566-00153 | | | — | 2566-00142 | 2566-00135 | — |
| V501SS & V502SS | -4 | — | | 2566-00132 | — | 2566-00108 | 2566-00146 | — | 2566-00138 |
| | -6 | — | | 2566-00132 | — | 2566-00108 | 2566-00146 | — | 2566-00138 |
| | -8 | — | | 2566-00132 | — | 2566-00108 | 2566-00146 | — | 2566-00138 |
| | -12 | — | | 2566-00133 | — | 2566-00109 | — | — | 2566-00184 |
| | -16 | — | | 2566-00133 | — | 2566-00109 | — | — | 2566-00184 |
| V502SS | -20 | — | | 2566-00134 | — | | — | — | 2566-00185 |
| | -24 | — | | 2566-00134 | — | | — | — | 2566-00185 |
| | -32 | — | | 2566-00134 | — | | — | — | 2566-00185 |
| V500CS & V502CS | -4 | 2566-00158 | | | 2566-00170 | 2566-00166 | | 2566-00162 | |
| | -6 | 2566-00158 | | | 2566-00170 | 2566-00166 | | 2566-00162 | |
| | -8 | 2566-00158 | | | 2566-00171 | 2566-00166 | | 2566-00162 | |
| | -12 | 2566-00159 | | | 2566-00172 | 2566-00167 | | 2566-00163 | |
| | -16 | 2566-00159 | | | 2566-00172 | 2566-00167 | | 2566-00163 | |
| | -20 | 2566-00160 | | | | 2566-00168 | | 2566-00164 | |
| | -24 | 2566-00160 | | | | 2566-00168 | | 2566-00164 | |
| | -32 | 2566-00161 | | | | 2566-00169 | | 2566-00165 | |
| V506CS | -4 | 2566-00158 | | | 2566-00170 | 2566-00166 | | 2566-00162 | |
| | -6 | 2566-00158 | | | 2566-00170 | 2566-00166 | | 2566-00162 | |
| | -8 | | | | | | | 2566-00234 | |
| | -12 | — | | | | | | 2566-00235 | |
| | -16 | — | | | | | | 2566-00236 | |
| V533P | -4 | 2560-10152 | 2566-00105 | | 2566-00147 | 2566-00215 | 2566-00231 | 2560-10160 | |
| | -6 | 2560-10152 | 2566-00105 | | 2566-00147 | 2566-00215 | 2566-00231 | 2560-10160 | |
| | -8 | 2560-10152 | 2566-00105 | | 2566-00147 | 2566-00215 | 2566-00231 | 2560-10160 | |
| | -12 | 2560-10153 | 2566-00178 | | 2566-00179 | 2566-00180 | | 2560-10168 | |
| | -16 | 2560-10153 | 2566-00178 | | 2566-00179 | 2566-00180 | | 2560-10168 | |
| V520P | -4 | | | | 2566-00277 | | | 2566-00262 | |
| | -6 | | | | 2566-00277 | | | 2566-00262 | |
| | -8 | | | | 2566-00277 | | | 2566-00262 | |
| | -12 | | | | 2566-00280 | | | 2566-00261 | |
| | -16 | | | | 2566-00280 | | | 2566-00261 | |
| | -20 | 2566-00143 | 2566-00153 | | | | | 2566-00135 | |
| | -24 | 2566-00143 | 2566-00153 | | | | | 2566-00135 | |
| | -32 | 2566-00143 | 2566-00153 | | | | | 2566-00135 | |
| | 40 | 2566-00253 | | | | | | | |
| 48 | 2566-00253 | | | | | | | | |
| V500HP, V506HP, V507HP | -4 | | | | | | | BVHPLK-1 ^A | |
| | -6 | | | | | | | BVHPLK-1 ^A | |
| | -8 | | | | | | | BVHPLK-1 ^A | |
| | -12 | | | | | | | BVHPLK-2 ^A | |
| | -16 | | | | | | | BVHPLK-2 ^A | |
| | -20 | | | | | | | BVHPLK-3 ^A | |
| | -24 | | | | | | | BVHPLK-3 ^A | |
| -32 | | | | | | | BVHPLK-3 ^A | | |

^A Locking kit for use with standard handles



Replacement Handle Nuts

| VALVE | PLATED STEEL | STAINLESS STEEL |
|----------|--------------|-----------------|
| V500P-4 | 2567-00020 | 2567-00023 |
| V500P-6 | 2567-00020 | 2567-00023 |
| V500P-8 | 2567-00020 | 2567-00023 |
| V500P-12 | 2567-00055 | 2567-00057 |
| V500P-16 | 2567-00055 | 2567-00057 |
| V500P-20 | 2567-00051 | 2567-00052 |
| V500P-24 | 2567-00051 | 2567-00052 |
| V500P-32 | 2567-00051 | 2567-00052 |
| V500CS-4 | 2567-00020 | 2567-00023 |
| V500CS-6 | 2567-00020 | 2567-00023 |
| V500CS-8 | 2564-00020 | 2567-00023 |

Replacement Handle Covers

| VALVE | LEVER | SHORT LEVER | TEE |
|----------|------------|-------------|------------|
| V500P-4 | 2569-00108 | 2569-00342 | 2569-00155 |
| V500P-6 | 2569-00108 | 2569-00342 | 2569-00155 |
| V500P-8 | 2569-00108 | 2569-00342 | 2569-00155 |
| V500P-12 | 2569-00296 | | 2569-00155 |
| V500P-16 | 2569-00296 | | 2569-00155 |
| V500P-20 | 2569-00229 | 2569-00234 | |
| V500P-24 | 2569-00229 | 2569-00234 | |
| V500P-32 | 2569-00229 | 2569-00234 | |
| V502SS-4 | | 2569-00203 | |
| V502SS-6 | | 2569-00203 | |
| V502SS-8 | | 2569-00203 | |

- A
- B
- C
- D
- E
- F
- G
- H
- I
- J
- K
- L
- M
- N
- O

| | |
|------------|--|
| STX | Stem Extension Kit |
| P | For use on Brass Ball Valves |
| 1 | 1: 1/4" thru 1/2" valves 2: 3/4" thru 1" valves |
| 125 | 125: 1-1/4" extension length 225: 2-1/4" extension length |

Note: Stem extensions cannot be used with series 509 and series 520.

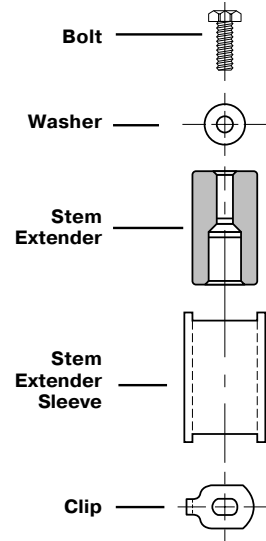

Brass Valve Extension Dimensions STX-P-1-125

| PART NO. | VALVE SIZE | B HEX | C HEX | H | L | M | N | D FLOW Ø |
|-------------|------------|--------|--------|------|------|------|------|----------|
| STX-P-1-125 | 1/4 | 15/16 | 15/16 | 3.96 | 4.96 | 2.03 | 3.73 | .375 |
| STX-P-1-125 | 3/8 | 15/16 | 15/16 | 3.96 | 4.96 | 2.03 | 3.73 | .375 |
| STX-P-1-125 | 1/2 | 1-1/16 | 1-1/16 | 3.96 | 5.05 | 2.20 | 3.84 | .500 |
| STX-P-2-125 | 3/4 | 1-1/4 | 1-5/16 | 3.96 | 5.25 | 2.42 | 4.06 | .685 |
| STX-P-2-125 | 1 | 1-1/2 | 1-9/16 | 3.96 | 5.89 | 2.75 | 4.33 | .875 |

Note: Drawing shows STX-P assembled to XV500P series-not included

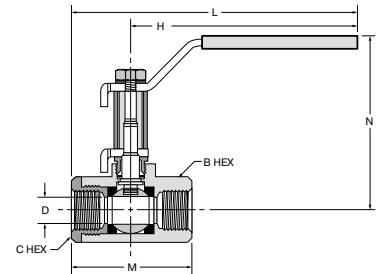

Brass Valve Extension Dimensions STX-P-1-225

| PART NO. | VALVE SIZE | B HEX | C HEX | H | L | M | N | D FLOW Ø |
|-------------|------------|--------|--------|------|------|------|------|----------|
| STX-P-1-225 | 1/4 | 15/16 | 15/16 | 3.96 | 4.96 | 2.03 | 4.73 | .375 |
| STX-P-1-225 | 3/8 | 15/16 | 15/16 | 3.96 | 4.96 | 2.03 | 4.73 | .375 |
| STX-P-1-225 | 1/2 | 1-1/16 | 1-1/16 | 3.96 | 5.05 | 2.20 | 4.84 | .500 |
| STX-P-2-225 | 3/4 | 1-1/4 | 1-5/16 | 3.96 | 5.25 | 2.42 | 5.06 | .685 |
| STX-P-2-225 | 1 | 1-1/2 | 1-9/16 | 3.96 | 5.89 | 2.75 | 5.33 | .875 |

Note: Drawing shows STX-P assembled to XV500P series-not included

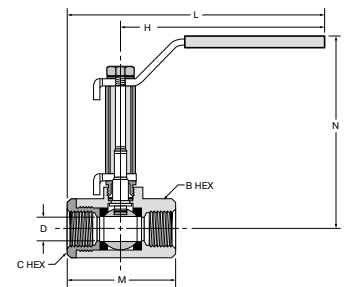

WARNING These products can expose you to chemicals including NICKEL or LEAD, which are known to the state of California to cause cancer, and LEAD which is known to cause birth defects or other reproductive harm. For more information go to www.P65Warnings.ca.gov.



A

B

C

D

E

F

G

H

I

J

K

L

M

N

O

Needle Valves



Parker's all brass needle valves have metal-to-metal seats with fine thread screwdown. The specially formulated low temperature seal remains elastic to temperatures as low as -40°F (-40°C).

Product Features:

- Extruded Brass Body & Stem
- Low Temperature Seal
- Metal-to-Metal Seal
- Pin Handle

Specifications:

Pressure Range:

- Up to 150 PSI (10.3 bar)

Temperature Range

- -40° to $+175^{\circ}\text{F}$ (-40° to $+79.4^{\circ}\text{C}$)
- Humidifier Valve Kit & Self Piercing Humidifier Kit:
 -30° to $+250^{\circ}\text{F}$ (-34.4° to $+121.1^{\circ}\text{C}$)
- NV311P/NV312P: 0° to $+150^{\circ}\text{F}$ (-17.7° to $+65.5^{\circ}\text{C}$)

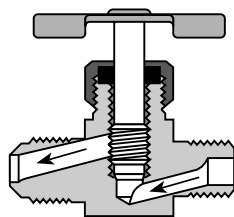
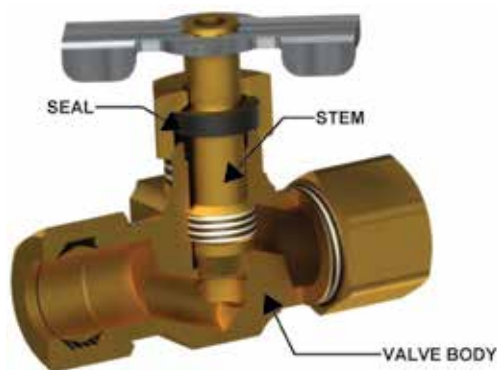

Needle Valves Installation Instructions

Series NV valves should always be installed with the pressure against the seat. Refer to drawing to determine correct direction of flow.

WARNING These products can expose you to chemicals including NICKEL or LEAD, which are known to the state of California to cause cancer, and LEAD which is known to cause birth defects or other reproductive harm. For more information go to www.P65Warnings.ca.gov.



Click here for CADs, Product Specifications or to Configure Parts Online

Angle Needle Valve NV101F

Flare to Male Pipe * Provided with Pin Handle
 Temperature Range: -45° to +250° F (-42.7° to +121.1° C)

| PART NO. | TUBE SIZE | PIPE THREAD | H | L | M | N |
|-------------|-----------|-------------|------|------|-----|-----|
| NV101F-4-2* | 1/4 | 1/8 | 1.50 | 1.58 | .75 | .66 |
| NV101F-6-4 | 3/8 | 1/4 | 1.38 | 1.86 | .95 | .90 |

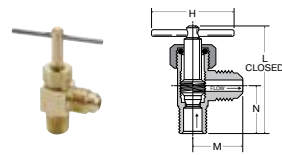

Needle Valve NV102F

Flare to Flare * Provided with Pin Handle
 Temperature Range: -45° to +250° F (-42.7° to +121.1° C)

| PART NO. | TUBE SIZE | H | L | M |
|-----------|-----------|------|------|------|
| NV102F-4* | 1/4 | 1.50 | 1.34 | 1.50 |

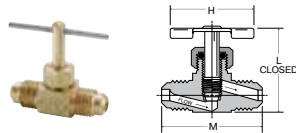

Needle Valve NV103F

Flare to Male Pipe * Provided with Pin Handle
 Temperature Range: -45° to +250° F (-42.7° to +121.1° C)

| PART NO. | TUBE SIZE | PIPE THREAD | H | L | M |
|-------------|-----------|-------------|------|------|------|
| NV103F-4-2* | 1/4 | 1/8 | 1.50 | 1.33 | 1.35 |

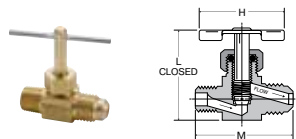

Humidifier Valve HV104C

Temperature Range: -45° to +250° F (-42.7° to +121.1° C)

| PART NO. | TUBE SIZE | PIPE THREAD | H | L | M |
|------------|-----------|-------------|------|------|-----|
| HV104C-4-2 | 1/4 | 1/8 | 1.50 | 1.89 | .53 |

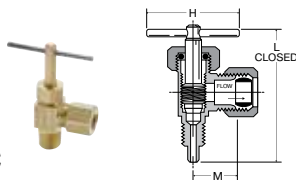

Humidifier Valve Clamp Kit HV104C-KIT

Temperature Range: -30° to +250° F (-34.4° to +121.1° C) Clamp fits 3/8" O.D. through 1.315" O.D. tube or pipe. Kit includes 60PT-4 and 63PT-4 for assembly with plastic or nylon tubing. For complete kit, specify entire part number as shown below:

| PART NO. | TUBE SIZE | PIPE THREAD |
|----------------|-----------|-------------|
| HV104C-4-2 KIT | 1/4 | 1/8 |

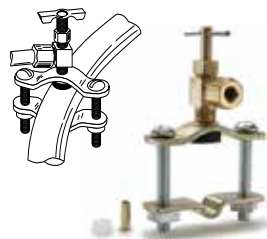

Self-Piercing Humidifier Valve Clamp Kit SPV104C-KIT

Temperature Range: -30° to +250° F (-34.4° to +121.1° C) Clamp fits 3/8" O.D. through 1.315" O.D. tube or pipe. Kit includes 60PT-4 and 63PT-4 for assembly with plastic or nylon tubing. For complete kit, specify entire part number as shown below:

Plastic sleeve and brass insert for 1/4" O.D. x .040 wall plastic tubing
 Brass sleeve for 1/4" O.D. copper tube

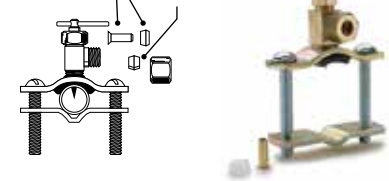

| PART NO. | TUBE SIZE | PIPE THREAD |
|-------------|-----------|-------------|
| SPV104C KIT | 1/4 | 1/8 |

Angle Needle Valve NV104C-NV104CA

Compression to Male Pipe * Provided with Pin Handle
 Temperature Range: -45° to +250° F (-42.7° to +121.1° C)

| PART NO. | TUBE SIZE | PIPE THREAD | H | L | M | N |
|--------------|-----------|-------------|------|------|-----|-----|
| NV104C-4-2* | 1/4 | 1/8 | 1.50 | 1.54 | .88 | .67 |
| NV104CA-4-2* | 1/4 | 1/8 | 1.50 | 1.49 | .77 | .66 |
| NV104C-4-4 | 1/4 | 1/4 | 1.38 | 1.80 | .93 | .75 |
| NV104C-5-2* | 5/16 | 1/8 | 1.50 | 1.63 | .88 | .68 |
| NV104C-6-4 | 3/8 | 1/4 | 1.38 | 1.76 | .94 | .81 |

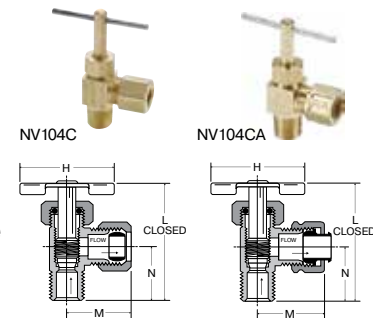

Needle Valve NV105C-NV105CA

Compression to Compression
 * Provided with Pin Handle
 Temperature Range: -45° to +250° F (-42.7° to +121.1° C)

| PART NO. | TUBE SIZE | H | L | M |
|------------|-----------|------|------|------|
| NV105C-4* | 1/4 | 1.50 | 1.41 | 1.75 |
| NV105C-5* | 5/16 | 1.50 | 1.35 | 1.73 |
| NV105C-6 | 3/8 | 1.38 | 1.55 | 1.93 |
| NV105CA-4* | 1/4 | 1.50 | 1.41 | 1.64 |
| NV105CA-6 | 3/8 | 1.38 | 1.55 | 1.78 |

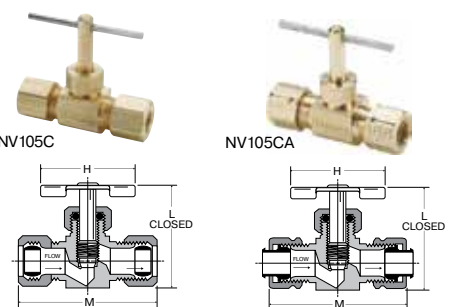

WARNING These products can expose you to chemicals including NICKEL or LEAD, which are known to the state of California to cause cancer, and LEAD which is known to cause birth defects or other reproductive harm. For more information go to www.P65Warnings.ca.gov.



Click here for CADs, Product Specifications or to Configure Parts Online

- A
- B
- C
- D
- E
- F
- G
- H
- I
- J
- K
- L
- M
- N
- O

Needle Valve NV106C-NV106CA

Compression to Male Pipe
 *Provided with Pin Handle
 Temperature Range: -45° to +250° F (-42.7° to +121.1° C)

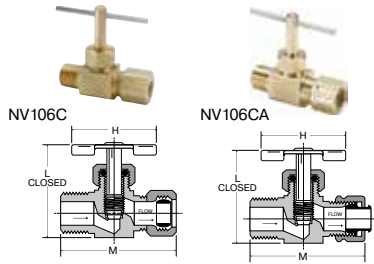

| PART NO. | TUBE SIZE | PIPE THREAD | H | L | M |
|--------------|-----------|-------------|------|------|------|
| NV106C-4-2* | 1/4 | 1/8 | 1.50 | 1.41 | 1.53 |
| NV106C-4-4* | 1/4 | 1/4 | 1.50 | 1.40 | 1.55 |
| NV106C-5-2* | 5/16 | 1/8 | 1.50 | 1.35 | 1.50 |
| NV106C-6-4 | 3/8 | 1/4 | 1.38 | 1.56 | 1.75 |
| NV106CA-4-2 | 1/4 | 1/8 | 1.50 | 1.41 | 1.47 |
| NV106CA-4-4* | 1/4 | 1/4 | 1.50 | 1.33 | 1.52 |
| NV106CA-6-4 | 3/8 | 1/4 | 1.38 | 1.53 | 1.78 |

Needle Valve NV107P

Male Pipe to Male Pipe
 *Provided with Pin Handle
 Temperature Range: -45° to +250° F (-42.7° to +121.1° C)

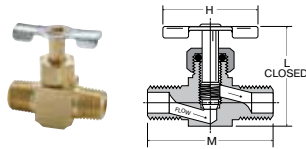

| PART NO. | PIPE THREAD | H | L | M |
|-----------|-------------|------|------|------|
| NV107P-2* | 1/8 | 1.50 | 1.35 | 1.25 |
| NV107P-4 | 1/4 | 1.38 | 1.54 | 1.65 |

Needle Valve NV108P

Female Pipe to Male Pipe
 *Provided with Pin Handle
 Temperature Range: -45° to +250° F (-42.7° to +121.1° C)

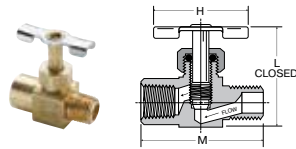

| PART NO. | PIPE THREAD | H | L | M |
|-----------|-------------|------|------|------|
| NV108P-2* | 1/8 | 1.50 | 1.36 | 1.24 |
| NV108P-4 | 1/4 | 1.38 | 1.56 | 1.61 |

Needle Valve NV109P

Female Pipe to Female Pipe
 *Provided with Pin Handle
 Temperature Range: -45° to +250° F (-42.7° to +121.1° C)

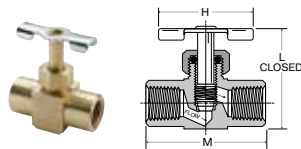

| PART NO. | PIPE THREAD | H | L | M |
|-----------|-------------|------|------|------|
| NV109P-2* | 1/8 | 1.50 | 1.35 | 1.25 |
| NV109P-4 | 1/4 | 1.38 | 1.53 | 1.60 |

Needle Valve NV311P

Poly-Tite to Male Pipe
 Temperature Range: 0° to +150° F (0° to +65.5° C)

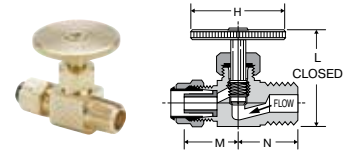

| PART NO. | TUBE SIZE | PIPE THREAD | H | L | M | N |
|------------|-----------|-------------|------|------|-----|-----|
| NV311P-4-2 | 1/4 | 1/8 | 1.07 | 1.17 | .50 | .63 |
| NV311P-4-4 | 1/4 | 1/4 | 1.07 | 1.18 | .50 | .72 |
| NV311P-6-4 | 3/8 | 1/4 | 1.07 | 1.19 | .56 | .72 |

Angle Needle Valve NV312P

Poly-Tite to Male Pipe
 Temperature Range: 0° to +150° F (0° to +65.5° C)

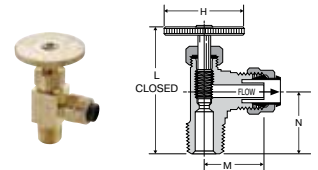

| PART NO. | TUBE SIZE | PIPE THREAD | H | L | M | N |
|------------|-----------|-------------|------|------|-----|-----|
| NV312P-4-2 | 1/4 | 1/8 | 1.07 | 1.53 | .48 | .68 |
| NV312P-4-4 | 1/4 | 1/4 | 1.07 | 1.72 | .56 | .86 |
| NV312P-6-4 | 3/8 | 1/4 | 1.07 | 1.68 | .64 | .86 |

WARNING These products can expose you to chemicals including NICKEL or LEAD, which are known to the state of California to cause cancer, and LEAD which is known to cause birth defects or other reproductive harm. For more information go to www.P65Warnings.ca.gov.

Drain Cocks/ Ground Plug Shutoff



Parker's ground plug shutoffs are manufactured from castings or forged bodies for extra strength. Hand tightening provides a metal-to-metal seal. Drain cocks are manufactured in both external and internal seats.

Specifications:

Pressure Range:

- Ground Plug Shutoff: 30 PSI (2.0 bar)
- Drain Cocks: Up to 150 PSI (10.3 bar)

Temperature Range

- Ground Plug Shutoff: 32° to +125° F (0° to +51.6° C)
- V406P/V407P: -40° to +180° F (-40° to +82.2° C)
- Drain Cocks: -65° to +250° F (-53.8° to +121.1° C)
- DCR601: -30° to +250° F (-34.4° to +121.1° C)



WARNING These products can expose you to chemicals including NICKEL or LEAD, which are known to the state of California to cause cancer, and LEAD which is known to cause birth defects or other reproductive harm. For more information go to www.P65Warnings.ca.gov.



A

B

C

D

E

F

G

H

I

J

K

L

M

N

O

[Click here for CADs, Product Specifications or to Configure Parts Online](#)

Ground Plug Shutoff V203F

Flare to Flare
 Temperature Range: +32° to +125° F (0° to +51.6° C)

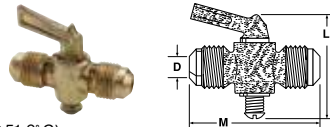

| PART NO. | TUBE SIZE | L | M | FLOW DIA. D |
|-----------|-----------|------|------|-------------|
| V203F-6-6 | 3/8 | 2.26 | 2.13 | .220 |
| V203F-8-8 | 1/2 | 2.26 | 2.50 | .281 |

Ground Plug Shutoff V204F

Flare to Male Pipe
 Temperature Range: +32° to +125° F (0° to +51.6° C)

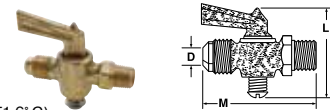

| PART NO. | TUBE SIZE | PIPE THREAD | L | M | FLOW DIA. D |
|-----------|-----------|-------------|------|------|-------------|
| V204F-4-2 | 1/4 | 1/8 | 1.85 | 2.00 | .188 |
| V204F-6-4 | 3/8 | 1/4 | 1.85 | 2.18 | .218 |

Ground Plug Shutoff V303C / V303CA

Compression to Compression
 Temperature Range: +32° to +125° F (0° to +51.6° C)

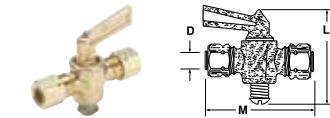

| PART NO. | TUBE SIZE | L | M | FLOW DIA. D |
|------------|-----------|------|------|-------------|
| V303C-4-4 | 1/4 | 1.88 | 2.33 | .188 |
| V303CA-4-4 | 1/4 | 1.90 | 1.75 | .188 |
| V303C-6-6 | 3/8 | 2.26 | 2.45 | .218 |
| V303CA-6-6 | 3/8 | 1.76 | 1.60 | .218 |

Ground Plug Shutoff V304C / V304CA

Compression to Male Pipe
 Temperature Range: +32° to +125° F (0° to +51.6° C)

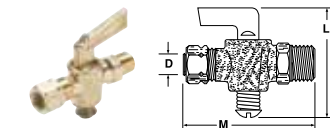

| PART NO. | TUBE SIZE | PIPE THREAD | L | M | FLOW DIA. D |
|------------|-----------|-------------|------|------|-------------|
| V304C-4-2 | 1/4 | 1/8 | 1.90 | 2.29 | .188 |
| V304CA-4-2 | 1/4 | 1/8 | 1.88 | 2.00 | .188 |
| V304C-4-4 | 1/4 | 1/4 | 1.90 | 2.15 | .188 |
| V304C-6-4 | 3/8 | 1/4 | 1.83 | 2.24 | .218 |
| V304CA-6-4 | 3/8 | 1/4 | 1.83 | 2.11 | .218 |

Ground Plug Shutoff V401P

Male Pipe to Male Pipe
 Temperature Range: +32° to +125° F (0° to +51.6° C)

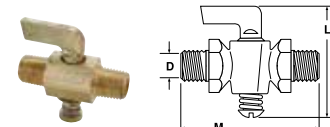

| PART NO. | PIPE THREAD | L | M | FLOW DIA. D |
|-----------|-------------|------|------|-------------|
| V401P-2-2 | 1/8 | 1.90 | 2.25 | .188 |
| V401P-4-4 | 1/4 | 1.90 | 1.98 | .188 |

Ground Plug Shutoff V402P

Female Pipe to Male Pipe
 Temperature Range: +32° to +125° F (0° to +51.6° C)

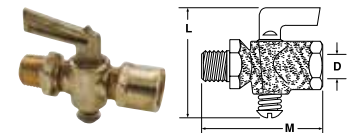

| PART NO. | FEMALE PIPE THREAD | PIPE THREAD | L | M | FLOW DIA. D |
|-----------|--------------------|-------------|------|------|-------------|
| V402P-2-2 | 1/8 | 1/8 | 1.85 | 1.78 | .218 |
| V402P-4-4 | 1/4 | 1/4 | 1.86 | 2.26 | .218 |
| V402P-6-6 | 3/8 | 3/8 | 2.34 | 2.21 | .245 |

Ground Plug Shutoff V403P

Female Pipe to Female Pipe
 Temperature Range: +32° to +125° F (0° to +51.6° C)

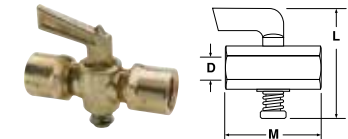

| PART NO. | FEMALE PIPE THREAD | L | M | FLOW DIA. D |
|------------|--------------------|------|------|-------------|
| V403P-2-2 | 1/8 | 1.90 | 1.51 | .218 |
| V403P-4-4 | 1/4 | 1.90 | 1.65 | .188 |
| V403P-6-6* | 3/8 | 2.25 | 2.00 | .250 |

*Made from extruded bar stock

Three-Way Valve V406P

Female Pipe three ends
 Temperature Range: -40° to +180° F (-40° to +82.2° C)

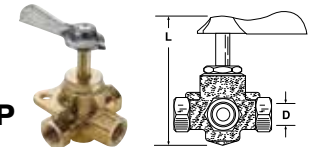

| PART NO. | PIPE THREAD | L | FLOW DIA. D |
|----------|-------------|------|-------------|
| V406P-4 | 1/4 | 3.10 | .281 |

Four-Way Valve V407P

Female Pipe four ends
 Temperature Range: -40° to +180° F (-40° to +82.2° C)

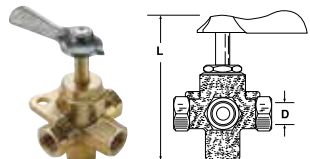

| PART NO. | PIPE THREAD | L | FLOW DIA. D |
|----------|-------------|------|-------------|
| V407P-4 | 1/4 | 3.30 | .281 |

Ground Plug Shutoff DC601

Temperature Range: +32° to +125° F (0° to +51.6° C)

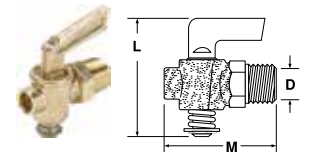

| PART NO. | PIPE THREAD | L | M | FLOW DIA. D |
|----------|-------------|------|------|-------------|
| DC601-2 | 1/8 | 1.90 | 1.40 | .170 |
| DC601-4 | 1/4 | 1.90 | 1.52 | .170 |
| DC601-6 | 3/8 | 2.26 | 1.74 | .281 |
| DC601-8 | 1/2 | 2.29 | 1.82 | .281 |

WARNING These products can expose you to chemicals including NICKEL or LEAD, which are known to the state of California to cause cancer, and LEAD which is known to cause birth defects or other reproductive harm. For more information go to www.P65Warnings.ca.gov.

[Click here for CADs, Product Specifications or to Configure Parts Online](#)

Drain Cock DCR601

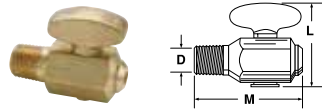

Temperature Range: -30° to +250° F (-34.4° to +121.1° C)

| PART NO. | PIPE THREAD | L | M | FLOW DIA. D |
|----------|-------------|------|------|-------------|
| DCR601-4 | 1/4 | 1.41 | 1.73 | .156 |

Bib Drain Valve DC607

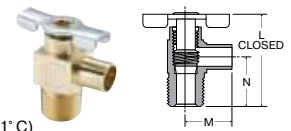

Temperature Range: -65° to +250° F (-53.8° to +121.1° C)

| PART NO. | HOSE SIZE | PIPE THREAD | FLOW | L | M | N |
|----------|-----------|-------------|------|------|-----|-----|
| DC607-4 | 3/8 | 1/4 | .28 | 1.32 | .67 | .71 |

Internal Seal Drain Cock DC602

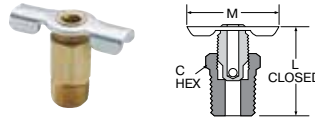

Temperature Range: -65° to +250° F (-53.8° to +121.1° C)

| PART NO. | PIPE THREAD | C HEX | L | M |
|----------|-------------|-------|-----|------|
| DC602-2 | 1/8 | 13/32 | .92 | 1.25 |
| DC602-4 | 1/4 | 9/16 | .94 | 1.25 |

Drain Cock DC603

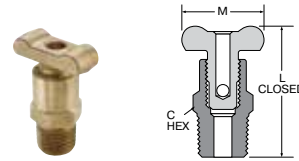

Temperature Range: -65° to +250° F (-53.8° to +121.1° C)

| PART NO. | PIPE THREAD | C HEX | L | M |
|----------|-------------|-------|------|------|
| DC603-2 | 1/8 | 5/8 | 1.41 | 1.00 |
| DC603-4 | 1/4 | 5/8 | 1.54 | 1.16 |
| DC603-6 | 3/8 | 11/16 | 1.63 | 1.16 |

External Seal Drain Cock DC604

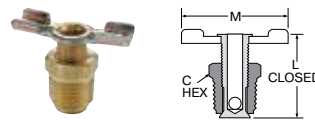

Temperature Range: -65° to +250° F (-53.8° to +121.1° C)

| PART NO. | PIPE THREAD | C HEX | L | M |
|----------|-------------|-------|------|------|
| DC604-2* | 1/8 | 7/16 | .85 | 1.25 |
| DC604-4 | 1/4 | 9/16 | 1.00 | 1.38 |
| DC604-6* | 3/8 | 11/16 | 1.22 | 1.68 |

*When assembled handle wings are down facing

External Seal Drain Cock DC606

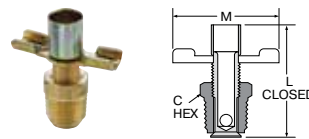

Temperature Range: -65° to +250° F (-53.8° to +121.1° C)

| PART NO. | PIPE THREAD | C HEX | L | M |
|----------|-------------|-------|------|------|
| DC606-4 | 1/4-18 | 9/16 | 1.50 | 1.38 |

WARNING These products can expose you to chemicals including NICKEL or LEAD, which are known to the state of California to cause cancer, and LEAD which is known to cause birth defects or other reproductive harm. For more information go to www.P65Warnings.ca.gov.



- A
- B
- C
- D
- E
- F
- G
- H
- I
- J
- K
- L
- M
- N
- O



Accessories

Blow Guns

Silencers

Bins, Bags
& Copper Tubing



For Bins information visit:
www.parker.com/bins



Blow Guns

410-S

Controlled Pressure
p. L6



410-SV

Controlled Pressure
p. L6



415-S

Controlled Pressure
p. L6



400-S-TIP

Replacement Tip
p. L6



410

Full Pressure
p. L6



410-N

Full Pressure
p. L6



415-N

Full Pressure
p. L6



BG441-NBL

BG Series
p. L7



BG442-SBL

BG Series
p. L7



BG443-NBL

BG Series
p. L7



BG444-SBL

BG Series
p. L7



Silencers

0673 0610 0670

Threaded Silencer
UNF, NPT or BSPP
p. L11



0671

Plug-In Silencer
p. L11



0673

Compact Threaded
Silencer Male
BSPP, M5
p. L11



0677

Miniature Silencer
BSPP
p. L11



0614 0672

Flow Control
Silencer Male NPT,
BSPP
p. L12



0611 0674

Threaded Silencer
NPT, BSPP, M5
p. L12



0676

Flow Control
Silencer BSPP
p. L12



0682

Stainless Steel
Threaded Silencer
Male BSPP
p. L12



0683

Stainless Steel
Threaded Silencer
Male NPT
p. L12



Bins

16-CB

16 Compartment
p. L13



24-CB

24 Compartment
p. L13



ADJ-CB

Adjustable
Compartments
p. L13



4CB-SR

Slide Rack
p. L13



LSR-STAND

Stand
p. L14



9-DC

9 Drawer
p. L14



18-DC

18 Drawer
p. L14



24B-CABINET

24 Opening
p. L14



40B-STAND

Stand
p. L14



40B-CABINET

40 Opening
p. L15



PNEU-CAB

Mobile Cabinet
p. L15



Bags

4X6PSB

Clear Plastic Bag
p. L15



6X8PSB

Clear Plastic Bag
p. L15



Copper Tubing

X50CT

Coiled Copper Tubing
p. L15



WARNING These products can expose you to chemicals including NICKEL or LEAD, which are known to the state of California to cause cancer, and LEAD which is known to cause birth defects or other reproductive harm. For more information go to www.P65Warnings.ca.gov.

[Click here for CADs, Product Specifications or to Configure Parts Online](#)

Blow Guns

Controlled Pressure Blow Guns

Parker Controlled Pressure Blow Guns meet OSHA requirements (section 29 CFR 1910.242 paragraph b), and directive #100-1. "Compressed air shall not be used for cleaning purposes except where reduced to less than 30 psi, and then only with effective chip guarding and personal protective equipment."

Parker Controlled Pressure Blow Guns have a black epoxy coated zinc body and vented nozzles to prevent pressure build-up when dead ending occurs up to 150 PSI (10.3 bar).

| SPECIFICATIONS | | |
|----------------|----------------------------|------------------|
| PART NO. | MAXIMUM PRESSURE PSI (BAR) | WT. (LB) P/PIECE |
| 410-S | 150 (10.3) | .50 |
| 410-SV | 150 (10.3) | .53 |
| 415-S | 150 (10.3) | .48 |



410-S

Parker Controlled Pressure Blow Guns features thumb lever valve actuator and brass nozzle. Inlet port is 1/4" NPT.



410-SV

Parker Venturi Nozzle Controlled Pressure Blow Gun with thumb lever valve and large venturi side ports for high volume flow. Inlet port is 1/4" NPT.



415-S

Parker Controlled Pressure Blow Guns features push button valve actuator and brass nozzle. Inlet port is 1/4" NPT.



400-S-TIP

Blow Gun Replacement Tip

Full Pressure Blow Guns

The following Parker Blow Guns must have a pressure regulator setting below 30 psi to conform to OSHA safety requirements 29 CFR 1910.242 Paragraph b.

| SPECIFICATIONS | | |
|----------------|----------------------------|------------------|
| PART NO. | MAXIMUM PRESSURE PSI (BAR) | WT. (LB) P/PIECE |
| 410 | 150 (10.3) | .48 |
| 410-N | 150 (10.3) | .51 |
| 415-N | 150 (10.3) | .49 |



410

Parker two way thumb lever valve has a zinc body with 1/4" NPT inlet and 1/8" NPSF outlet.

Note: Standard Gun without nozzle.



410-N

Parker thumb lever style Blow Gun features a zinc body, brass nozzle, and 1/4" NPT female inlet.



415-N

Parker Blow Gun features a push button style actuator, zinc body with a brass nozzle and 1/4" NPT female inlet.

WARNING These products can expose you to chemicals including NICKEL or LEAD, which are known to the state of California to cause cancer, and LEAD which is known to cause birth defects or other reproductive harm. For more information go to www.P65Warnings.ca.gov.



- A
- B
- C
- D
- E
- F
- G
- H
- I
- J
- K
- L
- M
- N
- O

[Click here for CADs, Product Specifications or to Configure Parts Online](#)

- A
- B
- C
- D
- E
- F
- G
- H
- I
- J
- K
- L
- M
- N
- O

BG Series Blow Guns

Made from impact resistant plastic, BG Series blow guns are durable and versatile. Extended nozzles allow air to be directed where it is required. The pistol grip trigger allows greater control over the amount of air delivered. Combined, these two features provide superior performance in a light weight, ergonomically designed package.

Nozzles are available in short and extended versions and most models meet OSHA directives on the use of compressed air for cleaning purposes. OSHA directive #100-1 states that “when dead ending occurs a static pressure at the main orifice shall not exceed 30 psi.” For those blow guns that do not meet this requirement, OSHA requires that “compressed air shall not be used for cleaning purposes except where reduced to less than 30 psi, and then only with effective chip guarding

and personal protective equipment” (section 29 CFR 1910.242 paragraph b). Please refer to the blow gun descriptions below for compatibility with OSHA directive #100-1.

Nozzle configurations are designed for maximum flexibility. Applications with special requirements may find the BG443-NBL with a 1/8” NPT fitting convenient for adapting existing nozzles or extra-long extensions. For information on specials or made-to-order blow gun nozzles, please contact the Fluid System Connectors Division.

- Easy to control variable flow pistol grip trigger.
- Nozzles available that meet OSHA requirements.
- Lightweight ergonomical design.
- Bodies are constructed of impact resistant plastic.

| SPECIFICATIONS | |
|--------------------|-----------------------|
| RATED PRESSURE PSI | 175 (12.0 bar) |
| TEMPERATURE RANGE | TO +120° F (+48.8° C) |
| INLET PORT | 1/4” NPTF |

| NOMENCLATURE | |
|-----------------------|--|
| EXAMPLE: BG442-SBL | ATTRIBUTE: |
| BG | BG SERIES BLOW GUN |
| 4 | INLET PORT IN 16THS |
| 42 | NOZZLE STYLE 41 - EXTENDED 42 - EXTENDED (OSHA) 43 - 1/8” FNPT 44 - SHORT (OSHA) |
| S | MEETS OSHA REQUIREMENTS S - YES N - NO |
| BL | COLOR BL - BLACK |

BG441-NBL BG Series Blow Gun

| PART NO. | NOZZLE | MEETS OSHA REQUIREMENTS |
|-----------|----------|-------------------------|
| BG441-NBL | EXTENDED | NO |



BG443-NBL BG Series Blow Gun

| PART NO. | NOZZLE | MEETS OSHA REQUIREMENTS |
|-----------|-----------------|-------------------------|
| BG443-NBL | 1/8” FEMALE NPT | NO |



BG442-SBL BG Series Blow Gun

| PART NO. | NOZZLE | MEETS OSHA REQUIREMENTS |
|-----------|----------|-------------------------|
| BG442-SBL | EXTENDED | YES |



BG444-SBL BG Series Blow Gun

| PART NO. | NOZZLE | MEETS OSHA REQUIREMENTS |
|-----------|--------|-------------------------|
| BG444-SBL | VORTEC | YES |



WARNING These products can expose you to chemicals including NICKEL or LEAD, which are known to the state of California to cause cancer, and LEAD which is known to cause birth defects or other reproductive harm. For more information go to www.P65Warnings.ca.gov.

Click here for CADs, Product Specifications or to Configure Parts Online

Silencers

Technical Specification of Silencers:

| MATERIAL | WORKING PRESSURE | WORKING TEMPERATURE |
|-----------------|--------------------|--------------------------------------|
| SINTERED BRONZE | 175 PSI (12.0 bar) | -4° to +300° F (-20° to +148.8° C) |
| POLYETHYLENE | 145 PSI (9.9 bar) | -14° to +175° F (-25.5° to +79.4° C) |
| STAINLESS STEEL | 175 PSI (12.0 bar) | -4° to +355° F (-20° to +179.4° C) |

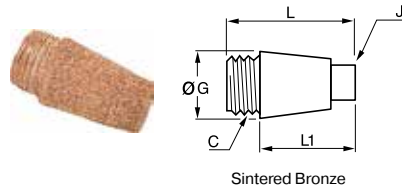

Sintered Bronze

0673 0610 0670 Threaded Silencer UNF, NPT or BSPP

| PART NO. | C UNF/NPT | J IN | G IN | L IN | L1 IN | WT OZ |
|-------------|--------------|---------|---------|---------|----------|----------|
| 0673 00 20* | 10-32 | .27 | .31 | .34 | .18 | .07 |
| 0610 00 11 | 1/8 | .31 | .42 | .89 | .71 | .21 |
| 0610 00 14 | 1/4 | .39 | .59 | 1.10 | .87 | .46 |
| 0610 00 18 | 3/8 | .51 | .75 | 1.42 | 1.14 | .85 |
| 0610 00 22 | 1/2 | .59 | .91 | 1.73 | 1.42 | 1.48 |

| PART NO. | C BSPP | J MM | G MM | L MM | L1 MM | WT KG |
|------------|-----------|---------|---------|---------|----------|----------|
| 0670 00 10 | G1/8 | 7 | 12 | 20.5 | 15 | .007 |
| 0670 00 13 | G1/4 | 8 | 15 | 24.5 | 18.5 | .013 |
| 0670 00 17 | G3/8 | 10 | 19 | 37 | 29 | .033 |
| 0670 00 21 | G1/2 | 14 | 23 | 40 | 31 | .049 |
| 0670 00 27 | G3/4 | 16.5 | 29.5 | 51 | 40.5 | .092 |
| 0670 00 34 | G1 | 20 | 36 | 60 | 49.5 | .140 |

* Brass Body

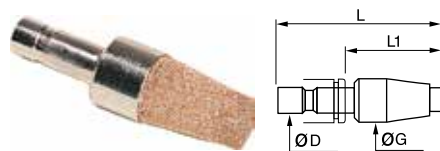

Body Nickel Plated
Brass Sintered Bronze

0671 Plug-In Silencer

| PART NO. | C | G MM | L MM | L1 MM | WT OZ |
|------------|----|---------|---------|----------|----------|
| 0671 04 00 | 4 | 13 | 41.5 | 24.5 | .015 |
| 0671 06 00 | 6 | 15 | 48 | 29 | .023 |
| 0671 08 00 | 8 | 15 | 49.5 | 29.5 | .024 |
| 0671 10 00 | 10 | 19.5 | 68 | 43.5 | .054 |
| 0671 12 00 | 12 | 20 | 68.5 | 43 | .055 |

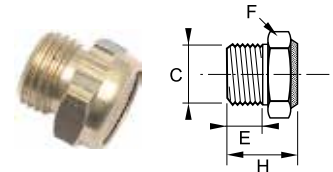

Body Nickel Plated Brass
Sintered Bronze

0673 Compact Threaded Silencer Male BSPP, M5

| PART NO. | C | E MM | F MM | H MM | WT OZ |
|------------|-----------|---------|---------|---------|----------|
| 0673 00 10 | G1/8 | 4 | 13 | 12 | .006 |
| 0673 00 13 | G1/4 | 6 | 16 | 16 | .012 |
| 0673 00 17 | G3/8 | 8 | 19 | 17 | .022 |
| 0673 00 19 | M5X0.8 | 8 | 8 | 8.5 | .001 |
| 0673 00 20 | UNF 10-32 | 4 | 6 | 11 | .006 |
| 0673 00 21 | G1/2 | 9 | 24 | 18 | .037 |

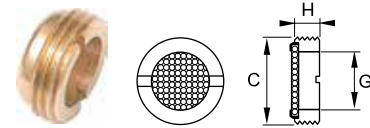

Body Nickel Plated Brass
Sintered Bronze

0677 Miniature Silencer BSPP

| PART NO. | C | G MM | H MM | WT OZ |
|------------|------|---------|---------|----------|
| 0677 00 10 | G1/8 | 5.5 | 4 | .002 |
| 0677 00 13 | G1/4 | 6 | 4.5 | .003 |
| 0677 00 17 | G3/8 | 9.5 | 5 | .006 |
| 0677 00 21 | G1/2 | 12.5 | 5.5 | .012 |
| 0677 00 27 | G3/4 | 19 | 6 | .014 |
| 0677 00 34 | G1 | 24 | 7 | .025 |

WARNING These products can expose you to chemicals including NICKEL or LEAD, which are known to the state of California to cause cancer, and LEAD which is known to cause birth defects or other reproductive harm. For more information go to www.P65Warnings.ca.gov.



Click here for CADs, Product Specifications or to Configure Parts Online

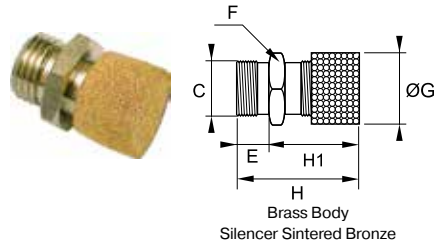

0614 0672 Flow Control Silencer Male NPT, BSPP

| PART NO. | C NPT | E | F MM | G | H MIN | H MAX | H1 | WT OZ |
|------------|-------|-----|------|------|-------|-------|------|-------|
| 0614 00 22 | 1/2 | .47 | 27 | 1.06 | 1.54 | 1.65 | 1.30 | 1.55 |

| PART NO. | C BSPP | E MM | F MM | G MM | H MIN | H MAX | H1 MM | WT KG |
|------------|--------|------|------|------|-------|-------|-------|-------|
| 0672 00 10 | 1/8 | 8 | 14 | 14 | 24 | 27 | 18 | .012 |
| 0672 00 13 | 1/4 | 8 | 17 | 17 | 25 | 28 | 19 | .023 |
| 0672 00 17 | 3/8 | 10 | 22 | 22 | 30 | 33 | 24 | .033 |
| 0672 00 21 | 1/2 | 12 | 27 | 27 | 39 | 42 | 33 | .044 |

Consult us for flow characteristics

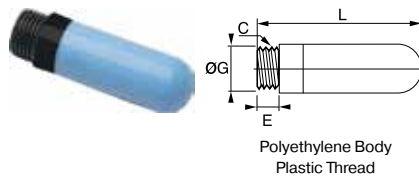

0611 0674 Threaded Silencer NPT, BSPP, M5

| PART NO. | C NPT | E IN | G IN | L IN | WT OZ |
|------------|-------|------|------|------|-------|
| 0611 00 11 | 1/8 | .24 | .49 | 1.34 | .07 |
| 0611 00 14 | 1/4 | .28 | .61 | 1.67 | .11 |
| 0611 00 22 | 1/2 | .43 | .93 | 3.07 | .35 |

| PART NO. | C BSPP | E MM | G MM | L MM | WT OZ |
|------------|--------|------|------|------|-------|
| 0674 00 19 | M5X0.8 | 4 | 6.5 | 23 | .001 |
| 0674 00 10 | G1/8 | 6 | 12.5 | 34 | .002 |
| 0674 00 13 | G1/4 | 7 | 15.5 | 42.5 | .003 |
| 0674 00 17 | G3/8 | 11.5 | 18.5 | 67.5 | .006 |
| 0674 00 21 | G1/2 | 11 | 23.5 | 78 | .010 |
| 0674 00 27 | G3/4 | 15.5 | 38.5 | 131 | .040 |
| 0674 00 34 | G1 | 19.5 | 49 | 160 | .050 |

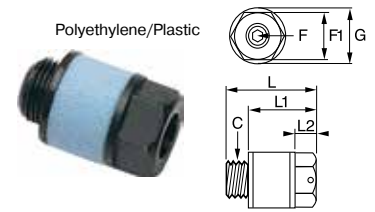

0676 Flow Control Silencer BSPP

| PART NO. | C BSPP | F MM | F1 MM | G MM | L MM | L1 MM | L2 MM | WT OZ |
|------------|--------|------|-------|------|------|-------|-------|-------|
| 0676 00 10 | G1/8 | 2.5 | 13 | 15 | 20.5 | 14.5 | 5 | .002 |
| 0676 00 13 | G1/4 | 4 | 15 | 18 | 29 | 22 | 7 | .007 |

| NO. OF TURNS | FLOW SCFM AT 87 PSI | | | | | | | | | NOISE LEVEL dBA* | |
|--------------|---------------------|------|-----|------|------|------|------|------|------|------------------|----|
| | 0 | 1 | 2 | 3 | 4 | 5 | 6 | 7 | 8 | | 9 |
| 0676 00 10 | 0 | 1.06 | 3.2 | 7.4 | 11.8 | 13 | 13.8 | 13.8 | 13.9 | 13.9 | 82 |
| 0676 00 13 | 0 | .78 | .88 | 1.77 | 12 | 26.5 | 33 | 34.6 | 35.3 | 36 | 84 |

* dBA at 87 PSI and 12 SCFM

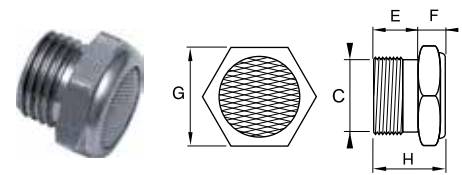

0682 Stainless Steel Threaded Silencer Male BSPP

| PART NO. | C BSPP | E MM | F MM | G MM | H MM | WT KG |
|------------|--------|------|------|------|------|-------|
| 0682 00 10 | G1/8 | 8 | 7 | 14 | 15 | .009 |
| 0682 00 13 | G1/4 | 8 | 7 | 17 | 15 | .013 |
| 0682 00 17 | G3/8 | 10 | 8 | 22 | 18 | .020 |
| 0682 00 21 | G1/2 | 12 | 10 | 27 | 22 | .038 |
| 0682 00 27 | G3/4 | 15 | 12 | 32 | 27 | .066 |
| 0682 00 34 | G1 | 18 | 14 | 38 | 32 | .118 |

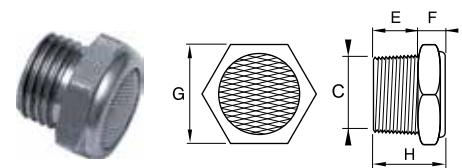

0683 Stainless Steel Threaded Silencer Male NPT

| PART NO. | C NPT | E IN | F IN | G MM | H IN | WT KG |
|------------|-------|------|------|------|------|-------|
| 0683 00 11 | 1/8 | .28 | .28 | 14 | .55 | .35 |
| 0683 00 14 | 1/4 | .43 | .28 | 17 | .71 | .53 |
| 0683 00 18 | 3/8 | .43 | .31 | 22 | .75 | .81 |
| 0683 00 22 | 1/2 | .59 | .39 | 27 | .98 | 1.55 |

WARNING These products can expose you to chemicals including NICKEL or LEAD, which are known to the state of California to cause cancer, and LEAD which is known to cause birth defects or other reproductive harm. For more information go to www.P65Warnings.ca.gov.

[Click here for CADs, Product Specifications or to Configure Parts Online](#)

Bins, Bags & Copper Tubing

16 Compartment Large Scoop Box

- Prime cold rolled steel outer shell
- High impact styrene insert with 16 compartments
- Scooped bottom compartments for easy part removal
- Full piano hinge on cover provides rigidity
- Positive pull-down catch keeps cover tightly closed to prevent part migration
- Handle allows for easy transport
- Durable gray powder coat finish

| PART NO. | DIMENSIONS (IN.) | | |
|----------|------------------|-------|--------|
| | WIDTH | DEPTH | HEIGHT |
| 16-CB | 18 | 12 | 3 |



24 Compartment Large Scoop Box

- Prime cold rolled steel outer shell
- High impact styrene insert with 24 compartments
- Scooped bottom compartments for easy part removal
- Full piano hinge on cover provides rigidity
- Positive pull-down catch keeps cover tightly closed to prevent part migration
- Handle allows for easy transport
- Durable gray powder coat finish

| PART NO. | DIMENSIONS (IN.) | | |
|----------|------------------|-------|--------|
| | WIDTH | DEPTH | HEIGHT |
| 24-CB | 18 | 12 | 3 |



ADJ-CB

- Prime cold rolled steel outer shell
- High impact styrene insert with 4 fixed vertical compartments and 9 moveable dividers adjustable on 1" centers
- Full piano hinge on cover provides rigidity
- Positive pull-down catch keeps cover tightly closed to prevent part migration
- Durable gray powder coat finish

| PART NO. | DIMENSIONS (IN.) | | | COMPARTMENTS |
|----------|------------------|-------|--------|--------------|
| | WIDTH | DEPTH | HEIGHT | |
| ADJ-CB | 18 | 12 | 3 | ADJUSTABLE |



Easy Glide Slide Rack (Holds 4 16-CB or 24-CB per rack)

- Sturdy construction using prime cold-rolled steel
- Each cradle holds up to 40 lbs
- Easy glide slides allow boxes to move in and out smoothly
- Center braces on cradles provide extra rigidity
- Reinforced rack keeps boxes level
- Boxes can be easily removed for transport to work areas
- Base and locking hinge are available as accessories
- Durable gray powder coat finish

| PART NO. | DIMENSIONS (IN.) | | |
|----------|------------------|-------|--------|
| | WIDTH | DEPTH | HEIGHT |
| 4CB-SR | 20 | 15.75 | 15 |



WARNING These products can expose you to chemicals including NICKEL or LEAD, which are known to the state of California to cause cancer, and LEAD which is known to cause birth defects or other reproductive harm. For more information go to www.P65Warnings.ca.gov.

- A
- B
- C
- D
- E
- F
- G
- H
- I
- J
- K
- L
- M
- N
- O

Click here for CADs, Product Specifications or to Configure Parts Online

LSR-Stand

- Sturdy all steel construction
- Legs attach easily using fasteners provided
- Raises units 15 inches off the floor
- Durable gray powder finish

| PART NO. | DIMENSIONS (IN.) | | |
|-----------|------------------|--------|--------|
| | WIDTH | DEPTH | HEIGHT |
| LSR-STAND | 20 5/8 | 16 1/4 | 15 5/8 |



9 Drawer Cabinet

- Prime cold rolled steel construction
- Each drawer includes 2 easy label dividers, which are adjustable on 1" centers
- High density drawer cabinet, easy to store large quantities of small parts
- Cabinets can be stacked using mounting holes
- Drawers feature interlocking design for superior strength
- Durable gray powder coat finish
- Drawers have full width handles and easy glide runners
- Ships fully assembled

| PART NO. | DIMENSIONS (IN.) | | | DRAWER DIMENSIONS (IN.) | | |
|----------|------------------|--------|--------|-------------------------|-------|--------|
| | WIDTH | DEPTH | HEIGHT | WIDTH | DEPTH | HEIGHT |
| 9-DC | 17.25 | 11.625 | 10.875 | 5.375 | 11.25 | 2.75 |



18 Drawer Cabinet

- Prime cold rolled steel construction
- Each drawer includes 2 easy label dividers, which are adjustable on 1" centers
- High density drawer cabinet, easy to store large quantities of small parts
- Cabinets can be stacked using mounting holes
- Drawers feature interlocking design for superior strength
- Durable gray powder coat finish
- Drawers have full width handles and easy glide runners
- Ships fully assembled

| PART NO. | DIMENSIONS (IN.) | | | DRAWER DIMENSIONS (IN.) | | |
|----------|------------------|--------|--------|-------------------------|-------|--------|
| | WIDTH | DEPTH | HEIGHT | WIDTH | DEPTH | HEIGHT |
| 18-DC | 17.25 | 11.625 | 21.25 | 5.375 | 11.25 | 2.75 |



24 Opening Bin

- All welded, prime cold rolled steel
- Modular with most 12" deep bins and drawer cabinets; mounting holes are located at both the top and bottom
- Fully hemmed 1 1/8" bin fronts to hold labels and retain parts
- Durable gray powder coat finish
- Roll-formed sides for increased strength and stability
- Ships fully assembled
- Ribbed and hemmed dividers provide added strength

| PART NO. | DIMENSIONS (IN.) | | | BIN DIMENSIONS (IN.) | | |
|-------------|------------------|-------|--------|----------------------|--------|--------|
| | WIDTH | DEPTH | HEIGHT | WIDTH | DEPTH | HEIGHT |
| 24B-CABINET | 33.75 | 12 | 23.875 | 5.375 | 11.875 | 5.5 |



Parker Brass Products Base Stand for 40B Cabinets

- Stands are 12" high
- Each stand includes a 15 piece bolt and nut set package for assembly
- Designed for use with 40B Cabinets

| PART NO. | DIMENSIONS (IN.) | | |
|-----------|------------------|-------|--------|
| | WIDTH | DEPTH | HEIGHT |
| 40B-STAND | 33.75 | 12 | 23.875 |



WARNING These products can expose you to chemicals including NICKEL or LEAD, which are known to the state of California to cause cancer, and LEAD which is known to cause birth defects or other reproductive harm. For more information go to www.P65Warnings.ca.gov.

[Click here for CADs, Product Specifications or to Configure Parts Online](#)

40 Opening Bin

- All welded, prime cold rolled steel
- Fully hemmed 1 1/8" bin fronts to hold labels and retain parts
- Roll-formed sides for increased strength and stability
- Ribbed and hemmed dividers provide added strength
- Modular with most 12" deep bins and drawer cabinets; mounting holes are located at both the top and bottom
- Durable gray powder coat finish
- Ships fully assembled



| PART NO. | DIMENSIONS (IN.) | | | BIN DIMENSIONS (IN.) | | |
|-------------|------------------|-------|--------|----------------------|--------|--------|
| | WIDTH | DEPTH | HEIGHT | WIDTH | DEPTH | HEIGHT |
| 40B-CABINET | 33.75 | 12 | 23.875 | 3.8125 | 11.875 | 3.8125 |

Pneumatic Cabinet

- High quality all-steel construction
- Partitioning slots provide flexibility for customization
- Drawer locks limit access to prevent loss and improve safety when moved
- Drawer interlock prevent opening multiple drawers that could cause accidental tip over
- Available fitting and connector labels with photos make easy selection and restock easy
- Locking 4" heavy-duty casters
- Retainer top with a non-skid mat work surface



| PART NO. | DIMENSIONS (IN.) | | | DRAWERS |
|----------|------------------|-------|--------|---------------|
| | WIDTH | DEPTH | HEIGHT | |
| PNEU-CAB | 22.1875 | 28.5 | 39.5 | 5-3" AND 1-9" |

Clear Plastic Shipping Bags PSB

Reusable, clear polyethylene, zip-lock style bags with panels for marking Part No., quantity, and availability information. Features easy visual part identification. Ideal for custom packaging of less than box quantities.



| PART NO. | SIZE |
|----------|---------|
| 4X6PSB | 4" X 6" |
| 6X8PSB | 6" X 8" |

Copper Tubing

Copper tubing meets A.S.T.M. specification B-280 (copper tube for refrigeration field service)

| PART NO. | TUBE O. D. | TUBE I. D. | WALL THICKNESS | FEET PER COIL |
|-----------|------------|------------|----------------|---------------|
| 50CT-2-30 | 1/8 | .065 | .030 | 50 |
| 50CT-3-30 | 3/16 | .128 | .030 | 50 |
| 50CT-4-30 | 1/4 | .190 | .030 | 50 |
| 50CT-5-32 | 5/16 | .249 | .032 | 50 |
| 50CT-6-32 | 3/8 | .311 | .032 | 50 |
| 50CT-8-32 | 1/2 | .436 | .032 | 50 |



WARNING These products can expose you to chemicals including NICKEL or LEAD, which are known to the state of California to cause cancer, and LEAD which is known to cause birth defects or other reproductive harm. For more information go to www.P65Warnings.ca.gov.

- A
- B
- C
- D
- E
- F
- G
- H
- I
- J
- K
- L
- M
- N
- O



Tube Fabricating Equipment

Tube Cutters

Tube Benders

Flaring Tools

In-Ex[®] Tube Deburring Tool





IMPERIAL
100

■ Tube Cutter

TC-1000-BPD
1/8" - 1 1/8"
p. M5



PTC-001
Plastic Tube cutter
p. M5



3000 71 11
For tubing &
push-on hose
p. M5



■ Flaring Tools

945TH-BPD
Flaring Tool
p. M6



■ Tube Deburring Tool

226-BPD
Deburring Tool
p. M6



■ Replacement Parts

PTC-001RB
Replacement
Blades
p. M5



 **WARNING** These products can expose you to chemicals including NICKEL or LEAD, which are known to the state of California to cause cancer, and LEAD which is known to cause birth defects or other reproductive harm. For more information go to www.P65Warnings.ca.gov.

[Click here for CADs, Product Specifications or to Configure Parts Online](#)

Tube Cutters

For hard or soft copper, aluminum, brass, thin wall steel, stainless steel, monel, titanium and other metal tubing. Rollers have flare cut-off groove, fold away reamer and spare cutting wheel.



| PART NO. | DESCRIPTION |
|--------------------|--|
| TC-1000-BPD | For 1/8" to 1 1/8" (4 to 28 mm) O.D. tubing, (1/8" to 1" nom.). Length: 4 15/16" Weight: 6 1/2 oz. |

Tube Cutters

Adjustable tube cutters to produce square cut ends with no external burr and minimum internal burring when used on fully annealed copper, brass, aluminum, and steel tubing. Features a hardened and burnished tool-steel cutting wheel, flare cut-off grooves in rollers for removal of old flares, swing-away reamer for removing internal burrs. Handle feeds and adjusts cutting wheel to uniformly cut tubing as the cutter is rotated.

NOTE: Tube cutters are not recommended for use with stainless steel tubing because of the work hardening effect. The use of a hacksaw with a "Tru-Kut" Sawing Vise or a rotary teeth saw is best recommended for stainless steel.



| PART NO. | DESCRIPTION |
|------------------|---|
| PTC-001 | Plastic Tube Cutter May be used with polyethylene, Polypropylene, nylon and other thermoplastic tubing. For tube O.D. sizes 1/8" to 1/2" |
| PTC-001RB | Replacement blades |



| PART NO. | DESCRIPTION |
|----------------------|--|
| 3000 71 11 | Tube cutter for tubing & push-on hose For hoses up to 1" (25mm) Weight: 1.09 oz. |
| 3000 71 11 05 | Replacement blades |

WARNING These products can expose you to chemicals including NICKEL or LEAD, which are known to the state of California to cause cancer, and LEAD which is known to cause birth defects or other reproductive harm. For more information go to www.P65Warnings.ca.gov.

- A
- B
- C
- D
- E
- F
- G
- H
- I
- J
- K
- L
- M
- N
- O

[Click here for CADs, Product Specifications or to Configure Parts Online](#)

- A
- B
- C
- D
- E
- F
- G
- H
- I
- J
- K
- L
- M
- N
- O

Flaring Tools



| PART NO. | DESCRIPTION |
|-----------|--|
| 945TH-BPD | Rolo-flair® Manual Rotary Flaring Tool |
| | For soft metal tubing. Precision burnished 45° flares in tube sizes from 2 (1/8" O.D.) to 12 (3/4" O.D.) with an easy turn of the handle. For copper and aluminum alloy. |
| | Weight: 2 1/2 lbs. |

In-Ex® Tube Deburring Tool



| PART NO. | DESCRIPTION |
|----------|---|
| 226-BPD | Insert tube into the convexed end of the In-Ex for inside deburring and the opposite end for outside deburring Rotate in either direction. Replacement blades can be ordered. |
| | Weight: 10 oz. |

WARNING These products can expose you to chemicals including NICKEL or LEAD, which are known to the state of California to cause cancer, and LEAD which is known to cause birth defects or other reproductive harm. For more information go to www.P65Warnings.ca.gov.



General Technical

Tubing Compatibility Chart

Manufacturing Techniques

Tube Line Fabrication Guide
for Leak Free Systems

Thread Specifications

Flaring Instructions

Thread Designations and Standards
for Threads Used in Fluid Connectors

Straight Thread Size Comparison Chart

S.A.E. Part Index

SAE Standards

U.L. Listed Fittings

Flow Curves

Flare and Thread Profiles

Pressure Conversions

English/Metric Conversions

Assembly Guides

Fluid Compatibility Guide



Tubing Compatibility Chart

A
B
C
D
E
F
G
H
I
J
K
L
M
N
O

| Nomenclature | | Soft Metal Tubing | | | Parflex Thermoplastic Tubing | | | | | | | | | | | |
|---|--|----------------------|----------|-------|--|------------------------------------|------------------------------|--|--------------------------------|-----------------------------|-----------------------------------|--|--|---|----------------------------------|----|
| | | Copper | Aluminum | Steel | Industrial Tubing Series (Outside Diameter Shown) | | | | | | | | | | | |
| | | | | | Polyethylene E & EB Inch (4,5,6,8,10) Metric (6,8,10,12) | Polyethylene PEFR Inch (2,3,4,6,8) | Polyethylene HDPE Inch (4,6) | Nylon N Inch (2,2.5,3,4,5,6,8) Metric (4mm - 20mm) | Nylon PAT Inch (2,4,6,8,10,12) | Nylon NR Inch (2,3,4,5,6,8) | Nylon NTNA Inch (2,2.5,3,4,5,6,8) | Polypropylene PP & PPB Inch (2,3,4,5,6,8,10) | 95U/95UM Series Inch (2,2.5,4,6,8,12) Metric (4,6,8,10,12) | Polyurethane HUFRR (Weld Tubing) Inch (4,6,8) | Clear Vinyl Inch (1/8" - 2 1/2") | |
| PS Plastic Sleeve & Tube Support Recommended TS Tube Support Is Recommended BS Brass Sleeve Recommended CL Clamp Required MG Metal Gripper Collet Recommended Tube/Fitting Combination Compatible Tube/Fitting Combination Not Compatible | | Product Sizes (inch) | | | | | | | | | | | | | | |
| Compression & Flare | Compression Inch (2,3,4,5,6,7,8,10,12) | BS | BS | | PS TS | PS TS | PS TS | PS TS | PS TS | PS TS | | PS TS | | | | |
| | Compress-Align Inch (2,3,4,5,6,8,10,12,14,16) | | | | TS | TS | TS | TS | TS | TS | | TS | | | | |
| | Metric Compression Metric (4,5,6,8,10,12,14,16,18,20,22,25,28) | | | | TS | | | TS | | TS | | TS | TS | | | |
| | Poly-Tite Inch (4,5,6,8) | BS | | | | | | BS | | | | BS | | | | |
| | Hi-Duty Inch (2,3,4,5,6,8,10) | | | | TS | TS | TS | TS | TS | TS | | TS | | | | |
| | 45 degree flare Inch (2,3,4,5,6,8,10,12,14) | | | | | | | | | | | | | | | |
| | Inverted Flare Inch (2,3,4,5,6,8,10,12) | | | | | | | | | | | | | | | |
| | Fast & Tite Inch (4,5,6,8,10) | | | | | | | | | | | | | TS | | TS |
| Push-to-Connect | Flow Controls Inch (2,2.5,4,5,6,8) Metric (4,6,8,10,12) | | | | | | | | | | | | TS | | | |
| | Prestolok PLP Metal Inch (2,2.5,3,4,5,6,8) | | | | | | | | | | | | | | | |
| | Prestolok PLP Composite Inch (2,2.5,3,4,5,6,8,10) Metric (3,4,6,8,10,12,14,16) | | | | | | | | | | | | TS | | | |
| | Prestolok PLM Metal Inch (2.5,4,5,6,8) Metric (4,6,8,10,12,14) | | | | | | | | | | | | | | | |
| | Prestolok PLS Stainless Steel Inch (2.5,3,4,5,6,8) Metric (4,6,8,10,12) | | | | | | | | | | | | | | | |
| | Liquifit Inch (2.5,4,6,8) Metric (4,6,8,10,12) | | | | | | | | | | | | | | | |
| | TrueSeal Inch (4,5,6,8) | MG | | | | | | | | MG | | MG | TS | | | TS |
| Barb | Par-Barb Inch (2,3,4,5,6,8,10,12,16,20,24) Inside Diameter | | | | | | | | | | | | | | | CL |
| | Dubl-Barb Inch (2.5,4,6,8) | | | | | | | | | | | | | | | |
| | Hose Barb Inch (2,3,4,5,6,8,10,12,16) Inside Diameter | | | | | | | | | | | | | | | CL |
| | Garden Hose | | | | | | | | | | | | | | | CL |
| DOT Transportation | NTA Inch (3,4,6,8,10,12) | | | | | | | | | | | | | | | |
| | Transmission Fittings Inch (2,2.5) | | | | | | | | | | | | | | | |
| | Air Brake Inch (4,6,8,10,12,16) | | | | | | | | | | | | | | | |
| | Air Brake Hose Inch (6,8) | | | | | | | | | | | | | | | |
| | Vibra-Lok Inch (2,3,4,5,6,8,10,12) | | | | | | | | | | | | | | | |
| | Prestomatic Inch (4,6,8,10) Metric (6,8,10,12,16) | | | | | | | | | | | | | | | |
| | PTC Inch (2.5,3,4,6,8,10,12) | | | | | | | | | | | | | | | |
| | SAE Cartridges Inch (4,6,8,10) | | | | | | | | | | | | | | | |



Tubing Compatibility Chart

| Parflex Thermoplastic Tubing | | | | Fluoropolymer Tubing | | | | IHP/HPD Hose | | Nomenclature | Product Sizes (inch) | | | | | | |
|--|---|--------------------------------------|---------------------------------------|--|---|---|-------------------------------------|--|---|---|--------------------------------|-----------------------------|-------------------|-------------------------------------|-------------------------------------|---|--|
| Transportation Tubing | | | | | | | | | | | | | | | | | |
| PFT Air Brake (SAE J644) Inch (2,2,3,4,5,6,8,10,12) | Air Brake DIN 74324 (Nylon 12) Metric (4,6,8,10,12,15,16,18) | PFT Diesel Fuel Sizes 4,6,8,10,12 | HTFL Diesel Fuel Sizes 4,6,8,10,12 | PFA Inch (3/32" - 1") Metric (4mm - 12mm) | FEP Inch (1/8" - 1") Metric (3mm - 12mm) | PTFE Inch (3/32" - 1.1") Metric (3mm - 16mm) | PVDF Inch (2,3,4,5,6,8,10,12,16) | GPH General Purpose Inch (3,4,6,8,12) Inside Diameter | Parker 271 hose (SAE J1402) Inch (6,8) Inside Diameter | PS Plastic Sleeve & Tube Support | TS Tube Support Is Recommended | BS Brass Sleeve Recommended | CL Clamp Required | MG Metal Gripper Collet Recommended | Tube/Fitting Combination Compatible | Tube/Fitting Combination Not Compatible | |
| | | | | PS TS | PS TS | PS TS | PS TS | | | Compression Inch (2,3,4,5,6,7,8,10,12) | Compression & Flare | | | | | | |
| | | | | TS | TS | TS | TS | | | Compress-Align Inch (2,3,4,5,6,8,10,12,14,16) | | | | | | | |
| | | | | TS | TS | TS | TS | | | Metric Compression Metric (4,5,6,8,10,12,14,16,18,20,22,25,28) | | | | | | | |
| | | | | | | | | | | Poly-Tite Inch (4,5,6,8) | | | | | | | |
| | | | | | | | | | | Hi-Duty Inch (2,3,4,5,6,8,10) | | | | | | | |
| | | | | | | | | | | 45 degree flare Inch (2,3,4,5,6,8,10,12,14) | | | | | | | |
| | | | | | | | | | | Inverted Flare Inch (2,3,4,5,6,8,10,12) | | | | | | | |
| | | | | | | | | | | Fast & Tite Inch (4,5,6,8,10) | Push-to-Connect | | | | | | |
| | | | | | | | | | | Flow Controls Inch (2,2.5,4,5,6,8) Metric (4,6,8,10,12) | | | | | | | |
| | | | | | | | | | | Prestolok PLP Metal Inch (2,2.5,3,4,5,6,8) | | | | | | | |
| | | | | | | | | | | Prestolok PLP Composite Inch (2,2.5,3,4,5,6,8,10) Metric (3,4,6,8,10,12,14,16) | | | | | | | |
| | | | | | | | | | | Prestolok PLM Metal Inch (2.5,4,5,6,8) Metric (4,6,8,10,12,14) | | | | | | | |
| | | | | | | | | | | Prestolok PLS Stainless Steel Inch (2.5,3,4,5,6,8) Metric (4,6,8,10,12) | | | | | | | |
| | | | | | | | | | | Liquifit Inch (2.5,4,6,8) Metric (4,6,8,10,12) | | | | | | | |
| | | | | MG | MG | MG | MG | | | TrueSeal Inch (4,5,6,8) | Barb | | | | | | |
| | | | | | | | | | | Par-Barb Inch (2,3,4,5,6,8,10,12,16,20,24) Inside Diameter | | | | | | | |
| | | | | | | | | | | Dubl-Barb Inch (2.5,4,6,8) | | | | | | | |
| | | | | | | | | | | Hose Barb Inch (2,3,4,5,6,8,10,12,16) Inside Diameter | | | | | | | |
| | | | | | | | | | | Garden Hose | | | | | | | |
| | | | | | | | | | | NTA Inch (3,4,6,8,10,12) | DOT Transportation | | | | | | |
| | | | | | | | | | | Transmission Fittings Inch (2,2.5) | | | | | | | |
| | | | | | | | | | | Air Brake Inch (4,6,8,10,12,16) | | | | | | | |
| | | | | | | | | | | Air Brake Hose Inch (6,8) | | | | | | | |
| | | | | | | | | | | Vibra-Lok Inch (2,3,4,5,6,8,10,12) | | | | | | | |
| | | | | | | | | | | Prestomatic Inch (4,6,8,10) Metric (6,8,10,12,16) | | | | | | | |
| | | | | | | | | | | PTC Inch (2.5,3,4,6,8,10,12) | | | | | | | |
| | | | | | | | | | | SAE Cartridges Inch (4,6,8,10) | | | | | | | |

- A
- B
- C
- D
- E
- F
- G
- H
- I
- J
- K
- L
- M
- N
- O

Manufacturing Techniques

Parker Extruded fittings

Hexagon, round and shaped bars are extruded in the configuration required, drawn to size, cut to length and straightened. First a solid round billet (8 to 12 inches in diameter) is heated to the pliable state and forced by pressure of approximately 80,000 pounds per square inch through a die. The resulting continuous length of bar is cooled and then drawn through dies to the desired external size. (The drawing process also controls the temper.) After straightening, the bar is ready for machining.

The process produces a dense, nonporous material somewhat stronger in the longitudinal direction due to an orientated flow of the grain.

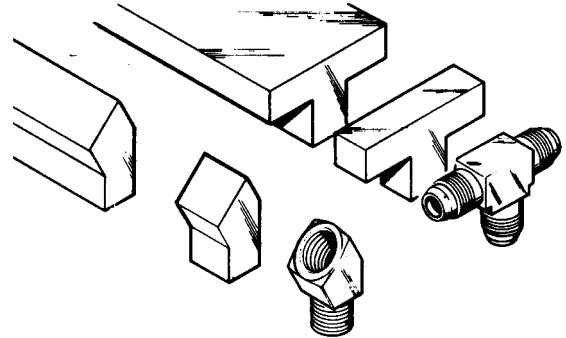

Material used for Parker Brass Fittings

(Reference SAE J461)

| | |
|------------------|---------------------------|
| Straight bodies: | barstock CA 360 or CA 345 |
| Shape bodies: | extruded barstock CA 360 |
| Shape bodies: | forged CA 377 |
| Nuts: | barstock CA 360 |
| Nuts: | forged CA 377 |

Parker Forged Fittings

Material for forgings is extruded in round bars, cut to length and straightened. (At this point in the process, forging rod differs from round extruded machinable bars only in temper and chemical properties.) After straightening, the bars are cut again into slugs (short lengths), reheated to the pliable state and pressed under a pressure of approximately 25,000 pounds per square inch between upper and lower die cavities. After cooling the flash is trimmed away and the forging blank is ready for machining.

This process of forming under extreme pressure produces a uniformly dense material of exceptional strength. Because grain flow follows the contour, the fitting has high impact strength and is more resistant to mechanical shock and vibration.

Of the major brass fittings producers, only Parker offers elbows and tees machined from both extruded and forged shapes.

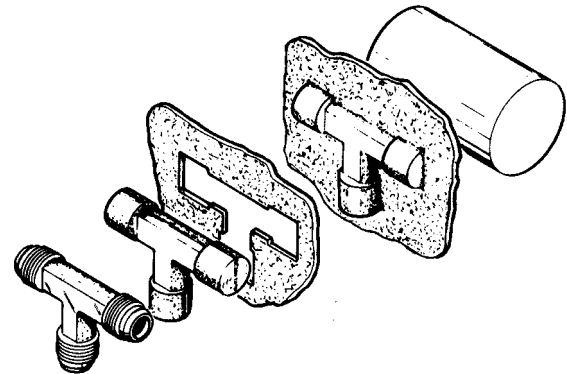

Tube Line Fabrication Guide for Leak Free Systems

Every hydraulic, pneumatic and lubrication system requires some form of tube line fabrication and fitting installation for completion. Proper fabrication and installation are essential for the overall efficiency, leak free performance, and general appearance of any system.

Start by planning ahead. After sizing the tube lines and selecting the appropriate style of fitting, consider the following in the design of your system:

1. Accessibility of joints
2. Proper routing of lines
3. Adequate tube line supports
4. Available fabricating tools

Routing of Lines

Routing of lines is probably the most difficult yet most significant of these system design considerations. Proper routing involves getting a connecting line from one point to another through the most logical path.

Always try to leave fitting joints as accessible as possible. Hard to reach joints are hard to assemble and tighten properly. Inaccessible joints are also more difficult and time consuming to service.

The most logical path should have the following characteristics:

- **Avoid excessive strain on joint** — A strained joint will eventually leak. (See Figures A14 through A21.)
- **Allow for expansion and contraction** — Use a “U” bend or a hose in long lines to allow for expansion and contraction. (See Figure A22.)
- **Allow for motion under load** — Even some apparently rigid systems do move under load. (See Figure A23.)
- **Get around obstructions without using excessive amount of 90° bends** — Pressure drop due to one 90° bend is greater than that due to two 45° bends. (See Figures A24 and A25.)
- Keep tube lines away from components that require regular maintenance. (See Figures A26 and A27.)
- Have a neat appearance and allow for easy troubleshooting, maintenance and repair. (See Figures A28 and A29.)

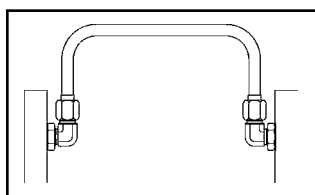

Fig. A14 — Correct Routing

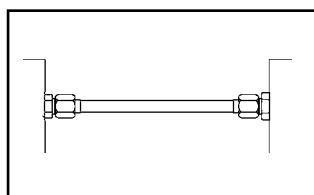

Fig. A15 — Incorrect Routing

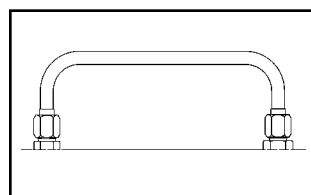

Fig. A18 — Correct Routing

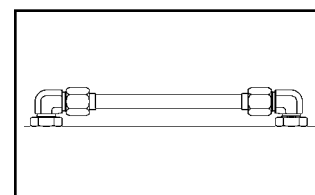

Fig. A19 — Incorrect Routing

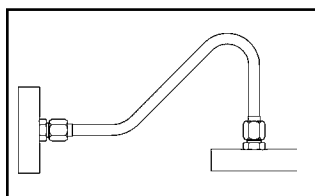

Fig. A16 — Correct Routing

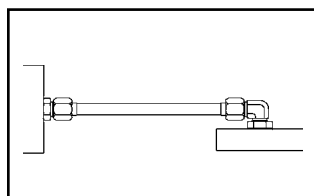

Fig. A17 — Incorrect Routing

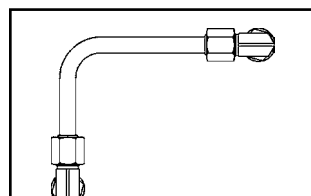

Fig. A20 — Correct Routing

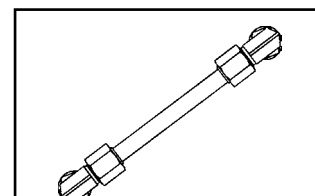

Fig. A21 — Incorrect Routing

(continued next page)

- A
- B
- C
- D
- E
- F
- G
- H
- I
- J
- K
- L
- M
- N
- O

- A
- B
- C
- D
- E
- F
- G
- H
- I
- J
- K
- L
- M
- N
- O

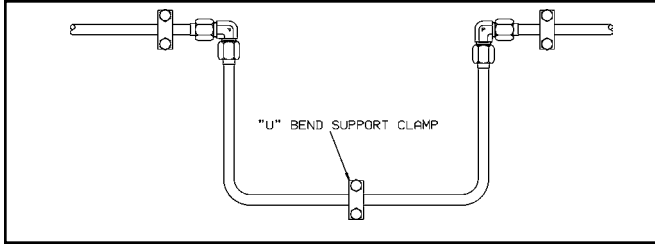

Fig. A22 — U-Bend Allowing Expansion and Contraction

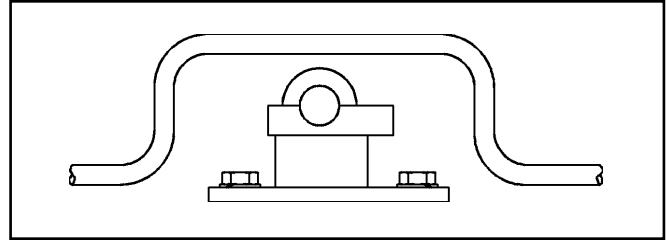

Fig. A25 — Incorrect

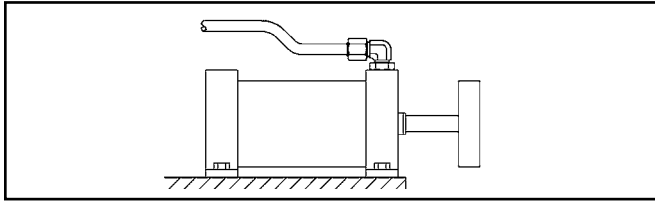

Fig. A23 — Bent Tube Allowing for Motion Under Load

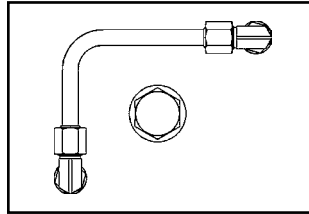

Fig. A26 — Correct

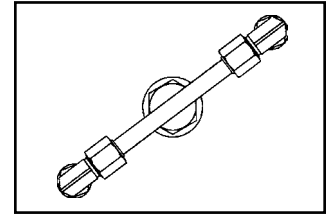

Fig. A27 — Incorrect

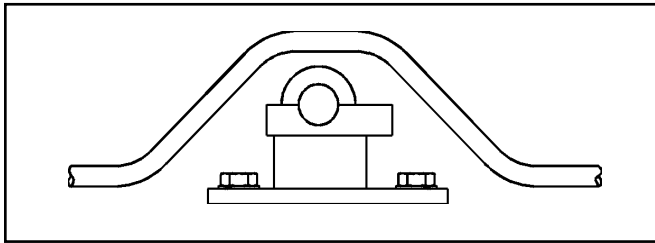

Fig. 24 — Correct

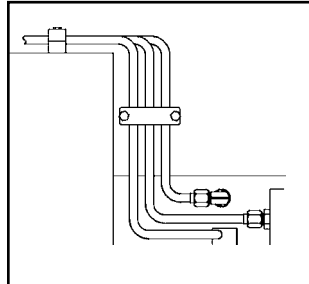

Fig. A28 — Correct

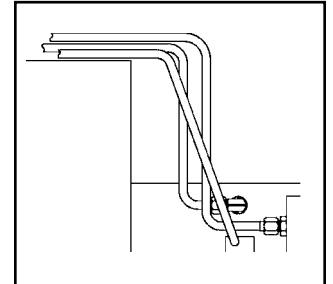

Fig. A29 — Incorrect

Thread Specifications

Dryseal Pipe Threads

All dryseal pipe threads are manufactured in accordance with the American National Standards Institute (ANSI) B1.20.3 specification and designed to seal pressure tight joints. The threads may incorporate the NPTF (National Standard Pipe Taper Fuel and Oil), PTF-SAE Short, PTF-SPL Short or PTF-SPL Extra Short form. Dryseal threads are used on brass products found within this catalog. Use of a thread sealant is recommended.

Non-Dryseal Pipe Threads

All non-dryseal pipe threads are manufactured in accordance with the American National Standards Institute (ANSI) B1.20.1 specification. These tapered pipe threads are used on our carbon and stainless steel products. Use of a thread sealant is recommended.

Nickel Plating

Nickel Plating is optional on standard product. Specifications for plating are not considered when standard product is manufactured. Since plating will alter thread pitch diameters, all plated threads should be qualified by functional fit with mating parts and not by standard thread gauging. Consult factory on plated product that will be qualified by standard thread gauging. These should be ordered as non-standards so product can be machined to pre-plated specifications.

Nickel plating provides a corrosion resistant coating which is desirable in many applications. Electrolytic nickel plating is the standard plating supplied unless otherwise specified. This will provide a uniform coverage of external surfaces; however, internal surfaces may be uncoated.

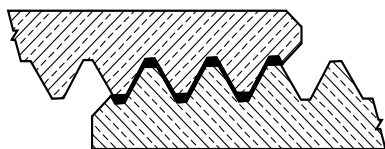

Dryseal Pipe Thread

Metal to metal contact. Crests of thread are crushed by the roots when wrench-tightened to form seal.

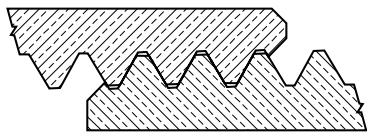

Non-Dryseal Pipe Thread

Flanks are in contact with possible clearance between the roots and crests. Will not prevent spiral leakage

Unified Threads

All threads in the columns headed "Straight Thread" found within this catalog are manufactured in accordance with the American National Standards Institute (ANSI) B1.1 specification.

British Standard Pipe Threads BSPT and BSPP

Pressure Tight

The British pipe threaded products found within this catalog intended for use where pressure tight joints are made on the threads are manufactured in accordance with British Standard (BS) 21 and International Standards Organization (ISO) 7-1. The threads are designated as follows:

- Rp: Internal parallel
- Rc: Internal taper
- Rs: Special external parallel
- R: External taper

Use of a thread sealant is recommended with the R series thread. An elastomeric peripheral seal should be used with the Rs thread.

Non-Pressure Tight

All British Standard parallel pipe threads manufactured in this catalog according to BS2779 and ISO 228-1 are intended for use where pressure tight joints are not made on the threads. An elastomeric peripheral seal should be used. These threads are designated as follows:

- G: Internal Thread
- GA, External thread, tight tolerance classification
- GB, External thread, general purpose and assumed if no classification designation is given

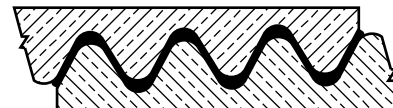

BS21 British Standard Pipe Thread for Pressure Tight Joints

Metal to metal contact provides seal as tapered thread is wrench-tightened.

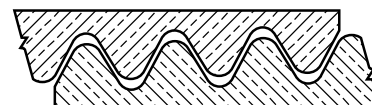

BS2779 British Standard Pipe Thread for Non-Pressure Tight Joints

Thread tolerances allow for possible clearance between threads. Will not prevent leakage paths.

- A
- B
- C
- D
- E
- F
- G
- H
- I
- J
- K
- L
- M
- N
- O

A
B
C
D
E
F
G
H
I
J
K
L
M
N
O

Pipe Thread Assembly

The two British Standard pipe thread forms used for Parker's standard product are manufactured in a tighter tolerance range than required by the standards in order to facilitate the assembly and mating of fittings produced by the two different standards. In general, BS21 threads do not necessarily mate with BS2779 threads at tolerance overlap conditions, but fittings located within this catalog can be assembled as follows:

| External Thread | Mating Internal Thread |
|---------------------|--|
| G-BS2779 (parallel) | G-BS2779 (parallel) Rp-BS21* (parallel) |
| Rs-BS21 (parallel) | Rp-BS21 (parallel) G-BS2779 (parallel) |
| R-BS21 (taper) | Rp-BS21 (parallel) Rc-BS21 (taper) G-BS2779 (parallel) |

*This thread must be manufactured within a reduced tolerance range to always assemble with the G series external thread.

British Standard ISO Metric Screw Threads

They are commonly used in miniature pneumatic applications because of the availability of small thread diameters and are also used extensively in the automotive industry. There are two forms of sealing on metric screw threads.

- O-ring sealing into a profiled port in accordance with ISO 6149.
- Peripheral sealing with a copper or bonded washer in accordance with ISO 261 and 262.

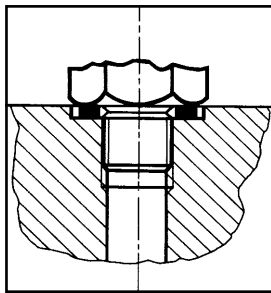

Peripheral sealing of parallel threads

Pressure-tight joints of screwed connections with parallel threads are achieved by placing a seal between the two machined faces

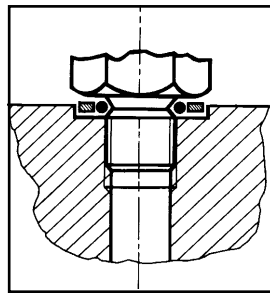

Flat seals

Washers and rings are manufactured in many different materials including copper, aluminium, fiber, plastics, etc.

The tightening torque at assembly must be carefully selected so as to avoid compressing the seal to the point of extrusion. As a general rule, the fitting should be tightened with an additional 1/4 wrench turn from the fingertight position.

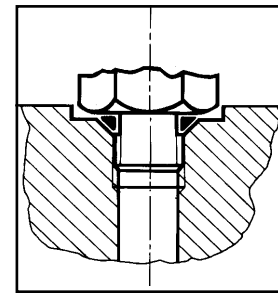

O-rings

Depending upon the configuration of the female port or male thread, O-Ring seals are fitted with or without back-up washers, and can be fully retained in a captive seal.

Flaring Instructions

In order to properly flare copping tubing for use with Parker 45° Flared Fittings and Inverted Flared Fittings, the following procedures and specifications should be met in preparation and make-up of flares.

1. Cut tube with tube cutter:

To minimize the burr and workhardening, use a light feed on the cutting wheel and make several revolutions.

2. Ream the tubing:

Cutting with a tube cutter will always create a burr. The burr must be removed to obtain maximum sealing surface. Remove only the burr, do not remove material from the original wall thickness. Also clean the tube end thoroughly to remove burrs.

3. Flare tubing: Flare with a compression or generating type flaring tool. Follow tool manufacturer’s instructions for: (a) positioning the tube in tool and (b) for the correct number of turns on the feed handle.

4. Inspect tubing: The flare cone should be checked for a smooth surface on the i.D. Of the cone and measure with micrometer over largest o.D. For proper size. (See dimensions below for flare size for each tubing size.)

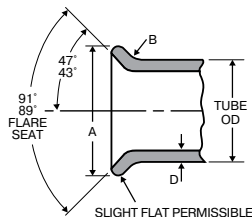

| NOMINAL TUBE | A SINGLE FLARE DIAMETER | | B SINGLE FLARE RADIUS | D SINGLE FLARE WALL THICKNESS |
|--------------|-------------------------|---------|-----------------------|-------------------------------|
| | IN | MAX. IN | MIN. IN | +/- 0.01 IN |
| 1/8 | .181 | .171 | .02 | .035 |
| 3/16 | .249 | .239 | .02 | .035 |
| 1/4 | .325 | .315 | .02 | .049 |
| 5/16 | .404 | .388 | .02 | .049 |
| 3/8 | .487 | .471 | .02 | .065 |
| 7/16 | .561 | .545 | .02 | .065 |
| 1/2 | .623 | .607 | .02 | .083 |
| 9/16 | .676 | .660 | .02 | .083 |
| 5/8 | .748 | .732 | .02 | .095 |
| 3/4 | .916 | .900 | .02 | .109 |
| 7/8 | 1.041 | 1.025 | .02 | .109 |
| 1 | 1.157 | 1.141 | .02 | .120 |

Thread Designations and Standards for Threads Used in Fluid Connectors

| | ABBREVIATION | DESCRIPTION | APPLICABLE STD. |
|---------------|------------------------------------|---|---|
| STRAIGHT PIPE | NPSC | AMERICAN STANDARD STRAIGHT PIPE THREADS IN PIPE COUPLINGS | ANSI B1.20.1 FED-STD-H28/7 |
| | NPSF | DRYSEAL AMERICAN STANDARD FUEL INTERNAL STRAIGHT PIPE THREADS (GENERALLY SED IN SOFT OR DUCTILE MATERIALS TO MATE WITH NPTF EXTERNAL TAPER THREADS) | SAE J476 ANSI B1.20.3 FED-STD-H28/8 |
| | NPSI | DRYSEAL AMERICAN INTERMEDIATE INTERNAL STRAIGHT PIPE THREADS (FOR BRITTLE OR HARD MATERIALS; INTENDED TO MATE WITH PTF-SAE SHORT EXTERNAL TAPER THREADS) | SAE J476 ANSI B1.20.3 FED-STD-H28/8 |
| | NPSM | AMERICAN STANDARD STRAIGHT PIPE THREADS FOR FREE-FITTING MECHANICAL JOINTS FOR FIXTURES (THESE THREADS FIT FREELY OVER NPTF THREADS. THEY ARE USED IN SWIVEL NUTS OF 07 ADAPTERS) | ANSI B1.20.1 FED-STD-H28/7 |
| TAPER PIPE | ANPT | AERONAUTICAL NATIONAL TAPER PIPE THREADS (SIMILAR TO NPT WITH VARIOUS ADDITIONAL REQUIREMENTS IN GAGING) | MIL-P-7105 |
| | NPT | AMERICAN STANDARD TAPER PIPE THREADS FOR GENERAL USE | ANSI B1.20.1 FED-STD-H28/7 |
| | NPTF | DRYSEAL AMERICAN STANDARD TAPER PIPE THREADS (USED IN ALL OF OUR STEEL AND BRASS FITTINGS) | SAE J476 ANSI B1.20.3 FED-STD-H28/8 |
| | PTF - SAE SHORT | DRYSEAL SAE SHORT TAPER PIPE THREADS (MAINLY USED IN LOW PRESSURE PNEUMATIC AND FUEL APPLICATIONS) | SAE J476 ANSI B1.20.3 FED-STD-H28/8 |
| | PTF - SPL SHORT ¹ | DRYSEAL SPECIAL SHORT TAPER PIPE THREADS | ANSI B1.20.3 |
| | PTF - SPL EXTRA SHORT ¹ | DRYSEAL SPECIAL EXTRA SHORT TAPER PIPE THREADS | ANSI B1.20.3 |

Continued next page



| | ABBREVIATION | DESCRIPTION | APPLICABLE STD. |
|-------------------|-----------------|---|--|
| UNIFIED THREADS | UN | UNIFIED CONSTANT PITCH THREADS (STANDARD SERIES: 4, 6, 8, 12, 16, 20, 28, 32) | ANSI B1.1 ED-STD-H28/2 |
| | UNC | UNIFIED COARSE THREADS | ANSI B1.1 FED-STD-H28/2 |
| | UNEF | UNIFIED EXTRA FINE THREADS | ANSI B1.1 FED-STD-H28/2 |
| | UNF | UNIFIED FINE THREADS | ANSI B1.1 FED-STD-H28/2 |
| | UNS | UNIFIED SPECIAL PITCH THREADS | ANSI B1.1 FED-STD-H28/3 |
| | UNJ | UNIFIED CONTROLLED ROOT RADIUS THREADS | ANSI B1.15 FED-STD-H28/4 |
| METRIC THREADS | M | METRIC SCREW THREADS — M PROFILE | ISO 261 ANSI B1.13M FED-STD-H28/21 |
| | M — KEG | METRIC TAPER THREADS (MAINLY USED IN GERMANY) | DIN 158 |
| BRITISH STANDARD | R (BSPT) | BRITISH STANDARD TAPER PIPE THREADS, EXTERNAL | BS 21 ISO 7/1 |
| | RC (BSPT) | BRITISH STANDARD TAPER PIPE THREADS, INTERNAL | BS 21 ISO 7/1 |
| | RP OR G (BSPP) | BRITISH STANDARD PIPE (PARALLEL) THREADS | BS 2779 ISO 228/1 |
| JAPANESE STANDARD | PF ² | JIS PARALLEL PIPE THREADS | JIS B202 ISO 228/1 |
| | PT ² | JIS TAPER PIPE THREADS | JIS B203 ISO 7/1 |
| | PS | JIS PARALLEL INTERNAL PIPE THREADS (TO MATE WITH PT THREADS) | JIS B203 |

Table A48 — Thread Designations and Standards for Threads Used in Fluid Connectors

- Used in some pneumatic components where shortened thread depth is required because of lack of enough material due to component size limitations.
- PF and PT threads are functionally interchangeable with BSPP and BSPT threads, respectively. These are old designations. They are being replaced with G (for PF) and R and Rc (for PT) as documents are revised.

Straight Thread Size Comparison Chart

| | TUBE O.D. | | | | | | | | | | |
|---|-------------|------------|-------------|-------------|--------------|--------------|--------------|--------------|---------------|---------------|---------------|
| | 1/8 | 3/16 | 1/4 | 5/16 | 3/8 | 7/16 | 1/2 | 5/8 | 3/4 | 7/8 | 1 |
| SAE 45° FLARED | 5/16 -24 | 3/8 -24 | 7/16 -20 | 1/2 -20 | 5/8 -18 | 11/16 -16 | 3/4 -16 | 7/8 -14 | 1-1/16 -14 | 1-1/4 -12 | - |
| INVERTED FLARED | 5/16 -28 | 3/8 -24 | 7/16 -24 | 1/2 -20 | 5/8 -18 | 11/16 -18 | 3/4 -18 | 7/8 -18 | 1-1/16 -16 | 1-3/16 -16 | - |
| AIR BRAKE/NTA | - | - | 7/16 -24 | - | 17/32 -24 | - | 11/16 -20 | 13/16 -18 | 1 -18 | - | 1-1/4 -16 |
| STANDARD COMPRESSION / COMPRESS-ALIGN | 5/16 -24 | 3/8 -24 | 7/16 -24 | 1/2 -24 | 9/16 -24 | 5/8 -24 | 11/16 -20 | 13/16 -18 | 1 -18 | 1-1/8 -18 | 1-1/4 -18 |
| POLY-TITE | | | 3/8 -24 | 7/16 -24 | 1/2 -24 | - | 11/16 -20 | - | - | - | - |
| VIBRA-LOK | 3/8 -24 | - | 1/2 -24 | 9/16 -24 | 5/8 -24 | - | 13/16 -18 | 1 -18 | 1-1/8 -18 | - | - |
| V510 BALL VALVES | - | - | 7/16 -20 | - | 9/16 -18 | - | 3/4 -16 | 7/8 -14 | 1-1/16 -12 | - | 1-5/16 -12 |
| HI-DUTY FLARELESS TUBE FITTINGS | 5/16 -24 | 3/8 -24 | 7/16 -20 | 1/2 -20 | 9/16 -20 | - | 11/16 -16 | 7/8 -18 | - | - | - |

S.A.E. Part Index

| <u>PART NO.</u> | <u>PAGE</u> | <u>PART NO.</u> | <u>PAGE</u> | <u>PART NO.</u> | <u>PAGE</u> | <u>PART NO.</u> | <u>PAGE</u> |
|------------------|-------------|--------------------|-------------|---------------------|-------------|--------------------|-------------|
| SAE 010101 | H8 | SAE 010202 | H10 | SAE 060102 BA..... | G9 | SAE 100203 BA..... | F9 |
| SAE 010102 | H9 | SAE 010203 | H11 | SAE 060103 BA..... | G9 | SAE 100302 BA..... | F9 |
| SAE 010103 | H9 | SAE 010302 | H11 | SAE 060110 | G8 | SAE 100401 BA..... | F8 |
| SAE 010104 | H8 | SAE 010401 | H10 | SAE 060111 | G8 | SAE 100424 BA..... | F9 |
| SAE 010105 | H12 | SAE 010424 | H11 | SAE 060115 | G8 | SAE 100425 BA..... | F9 |
| SAE 010106 | H12 | SAE 010425 | H10 | SAE 060201 BA | G10 | SAE 120101 BA..... | F13 |
| SAE 010107 | H12 | SAE 040101 | H14 | SAE 060202 BA | G10 | SAE 120102 BA..... | F13 |
| SAE 010108 | H7 | SAE 040102 | H14 | SAE 060203 BA | G11 | SAE 120103 BA..... | F13 |
| SAE 010109 | H12 | SAE 040103 | H14 | SAE 060401 BA | G10 | SAE 120111 | F13 |
| SAE 010110 | H8 | SAE 040110 | H14 | SAE 060424 BA | G11 | SAE 120115 | F13 |
| SAE 010111 | H8 | SAE 040202 | H15 | SAE 060425 BA | G11 | SAE 120201 BA..... | F13 |
| SAE 010112 | H12 | SAE 040203 | H15 | SAE 100101 BA..... | F7 | SAE 120202 BA..... | F14 |
| SAE 010113 | H7 | SAE 040302 | H15 | SAE 100102 BA..... | F8 | SAE 120203 BA..... | F14 |
| SAE 010114 | H7 | SAE 040401 | H14 | SAE 100103 BA..... | F8 | SAE 120302 BA..... | F14 |
| SAE 010165 | H7 | SAE 040424 | H15 | SAE 100110 | F7 | SAE 120401 BA..... | F13 |
| SAE 010166 | H7 | SAE 040425 | H15 | SAE 100115 | F7 | SAE 120424 BA..... | F14 |
| SAE 010167 | H7 | SAE 040427 | H15 | SAE 100201 BA..... | F8 | SAE 120425 BA..... | F14 |
| SAE 010201 | H11 | SAE 060101 BA..... | G8 | SAE 100202 BA..... | F9 | | |

SAE Standards

(Current)

- J246:** Spherical and Flanged Sleeve (Compression) Tube Fittings
Tubing: Copper and J844 Nylon
Fittings: NTA and Air Brake
- J476:** Dryseal Pipe Threads
- J512:** Automotive Tube Fittings
Tubing: Copper and Nylon
Fittings: 45° Flare, Inverted Flare, Compression
- J513:** Refrigeration Tube Fittings
Tubing: Annealed Copper
Fittings: 45° Flare
- J530:** Automotive Pipe Fittings
Fittings: Pipe
- J531:** Automotive Pipe, Filler and Drain Plugs
Fittings: Pipe Plugs
- J844:** Nonmetallic Air Brake System Tubing
Tubing: Non-reinforced Type A, reinforced Type B
- J1131:** Performance Requirements for SAE J844 Nonmetallic Tubing and Fitting Assemblies Used in Automotive Air Brake Systems
Tubing: J844 Nylon
Fittings: NTA and Prestomatic
- J1615:** Thread Sealants
- J2494:** Brass Body Push-to-Connect Fittings
Tubing: J844 Nylon
Fittings: Prestomatic



A

B

C

D

E

F

G

H

I

J

K

L

M

N

O

U.L. Listed Fittings

Many of the Fluid System Connectors Division's fittings have been listed by the Underwriter's Laboratory. The listings fall under 1 of 3 categories, depending upon application. Underwriter's requires that the smallest unit package carry the U.L. symbol and each carton be printed in accordance with the specification of each category.

List of U.L. Fittings

| FITTINGS, FLAMMABLE LIQUID | | | |
|----------------------------|--------|---------|---------|
| 1F | 62C | 168CA | 252IFHD |
| 2GF | 62CA | 169C | 256IF |
| 3GF | 62CABH | 169CA | 259IFHD |
| 14FL | 62CBH | 170C | 264C |
| 14FSV | 66C | 170CA | 264CA |
| 14FSX | 66CA | 171C | 265C |
| 41FL | 68C | 171CA | 265CA |
| 41FS | 68CA | 172C | 269C |
| 41FX | 144F | 172CA | 269CA |
| 41IF | 145F | 176C | 270C |
| 41IFS | 147F | 176CA | 270CA |
| 42F | 149F | 177C | 639C |
| 42IFHD | 150F | 177CA | 639CA |
| 46F | 151F | 244F | 639F |
| 46IFHD | 155F | 244IFHD | 640F |
| 48F | 159F | 245IFHD | 660FHD |
| 48IFHD | 164C | 249F | 661FHD |
| 60C | 164CA | 249IF | 664FHD |
| 61C | 165C | 249IFHD | |
| 61CA | 165CA | 250IFHD | |
| 61CL | 168C | 251IFHD | |

| FITTINGS, FUEL EQUIPMENT, MARINE | | | |
|----------------------------------|------|--------|--------|
| 2GF | 144F | 155F | 664FHD |
| 3GF | 145F | 159F | |
| 14FL | 147F | 639F | |
| 42F | 149F | 640F | |
| 46F | 150F | 660FHD | |
| 48F | 151F | 661FHD | |

| SHUT-OFF VALVES, FLAMMABLE LIQUIDS, LP GAS AND COMPRESS GAS | | |
|---|-----------|-----------|
| XV520P-4 | XV520P-20 | XV500P-20 |
| XV520P-6 | XV520P-24 | XV500P-24 |
| XV520P-8 | XV520P-32 | XV500P-32 |
| XV520P-12 | XV520P-40 | |
| XV520P-16 | XV520P-48 | |

Flow Curves

87 PSI (5.9 bar) ■ Return Direction ■ Controlled Direction N = Number of Turns F = Flow in SCFM

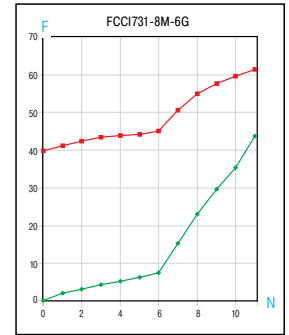
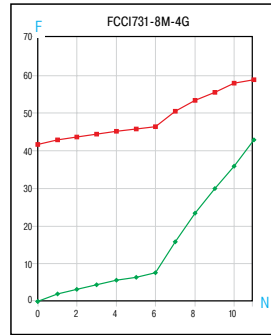
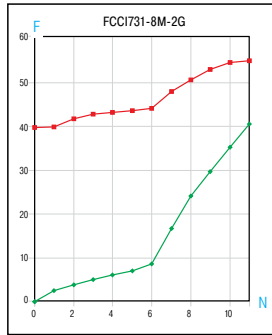
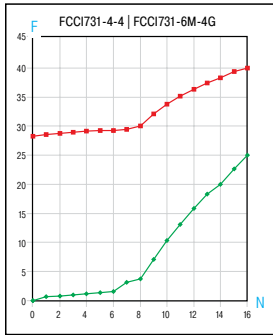
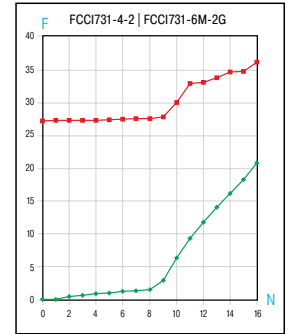
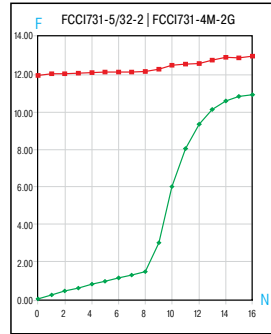
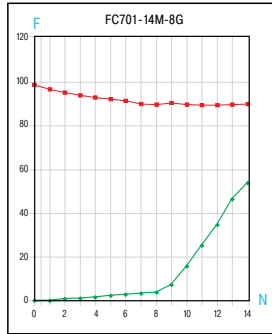
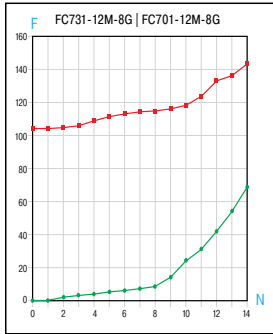
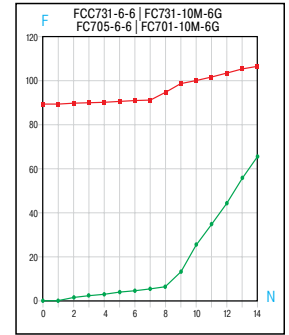
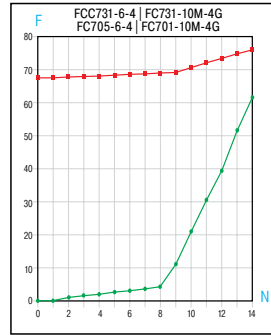
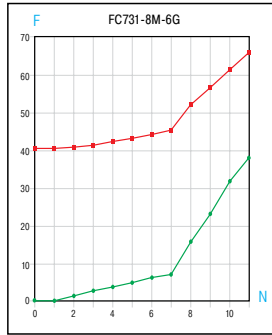
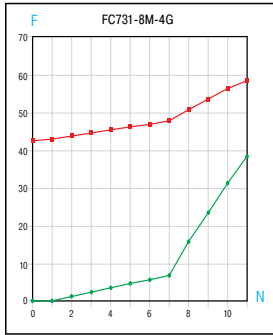
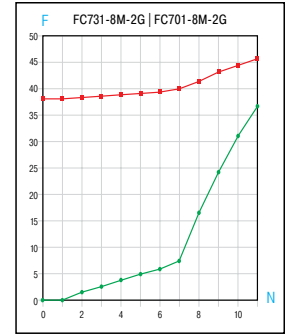
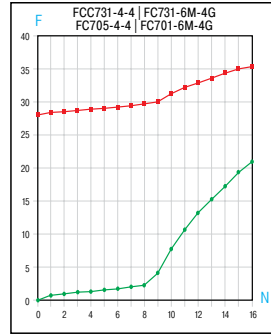
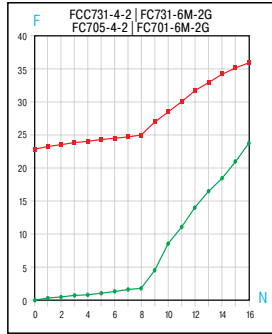
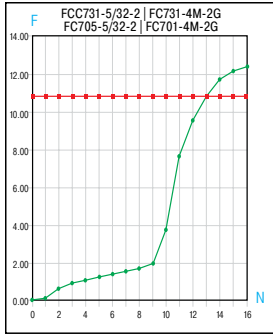

87 PSI (5.9 bar) ■ Return Direction ■ Controlled Direction N = Number of Turns F = Flow in SCFM

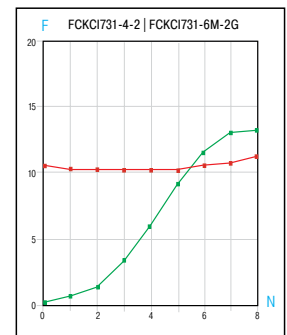
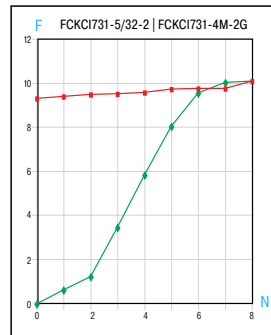
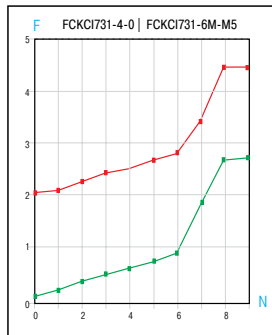
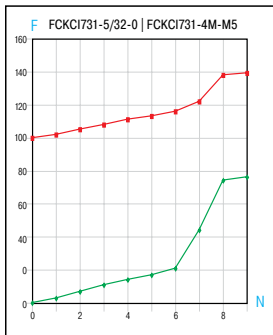
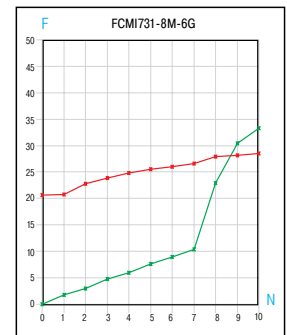
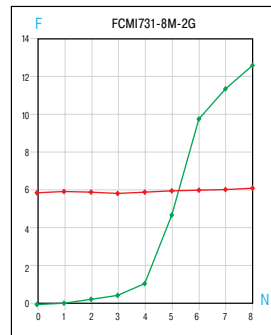
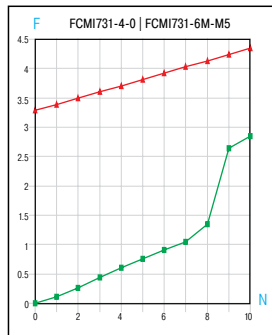
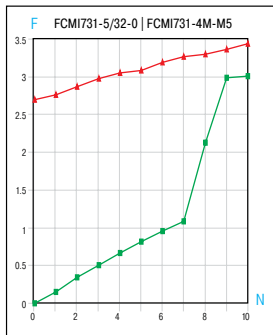
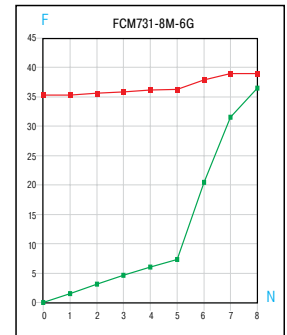
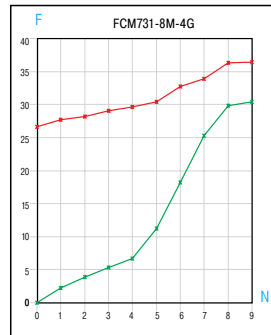
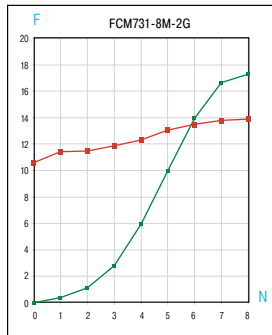
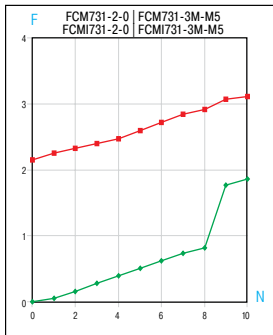
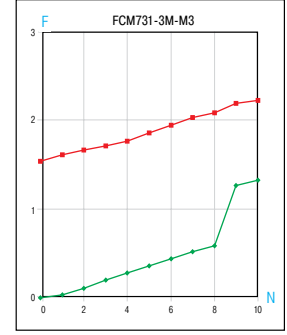
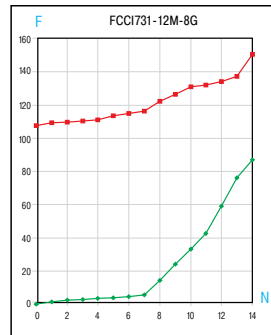
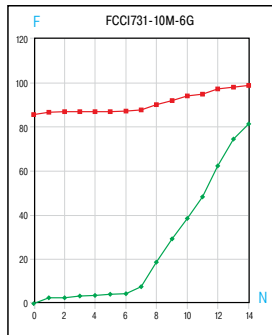
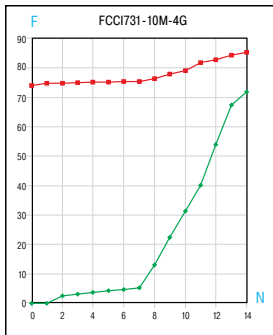

87 PSI (5.9 bar) ■ Return Direction ■ Controlled Direction N = Number of Turns F = Flow in SCFM

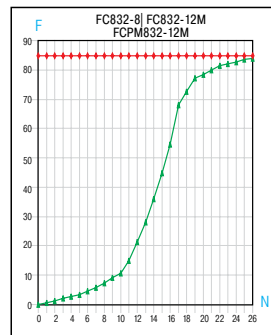
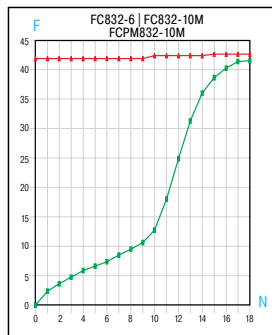
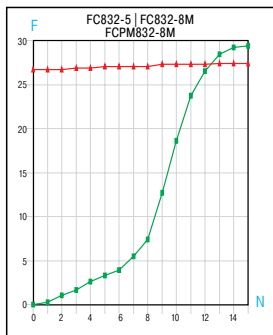
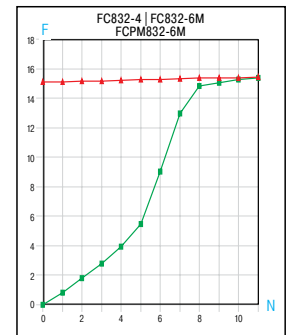
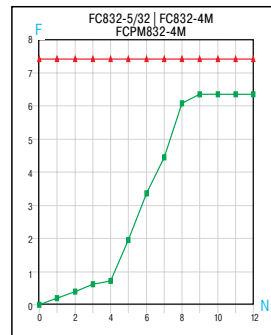
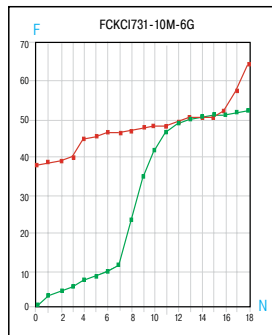
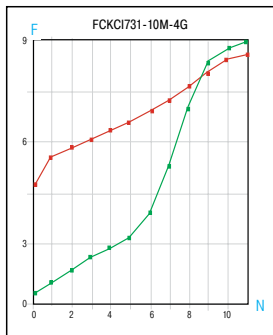
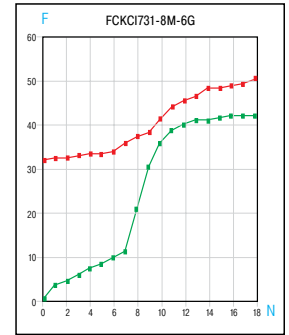
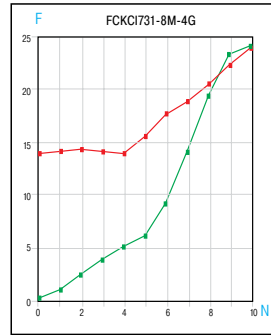
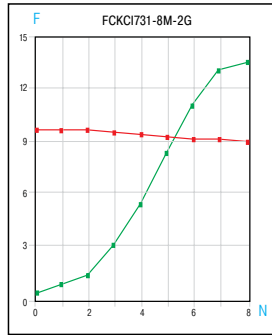
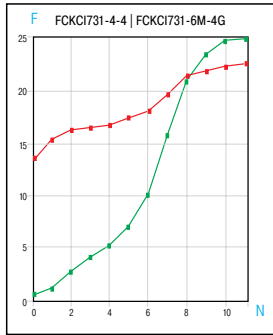

- A
- B
- C
- D
- E
- F
- G
- H
- I
- J
- K
- L
- M
- N
- O

87 PSI (5.9 bar) Return Direction Controlled Direction N = Number of Turns F = Flow in SCFM

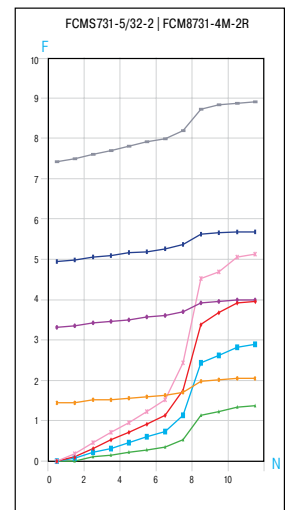
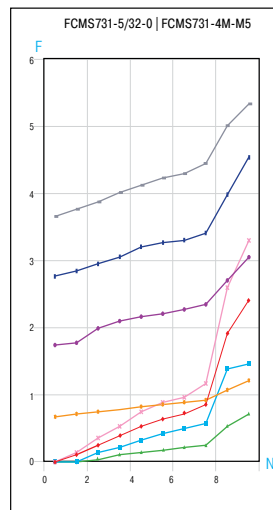
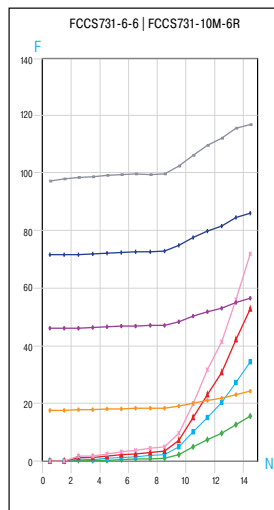
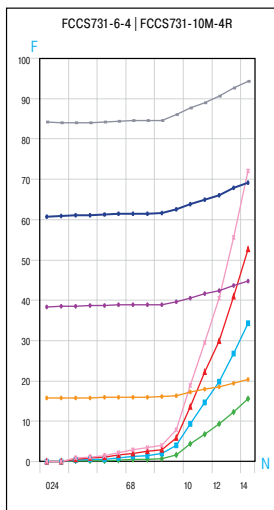
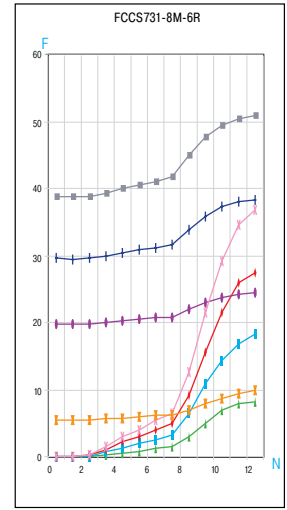
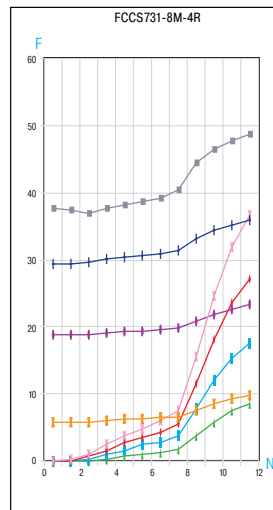
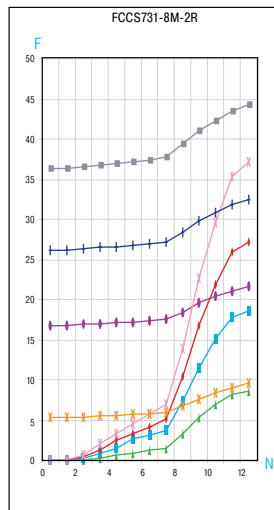
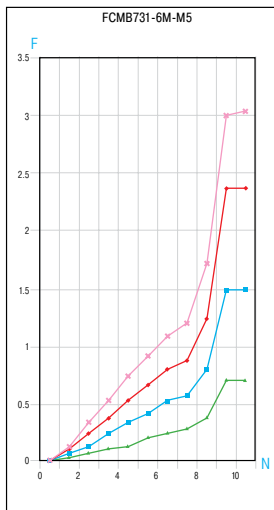
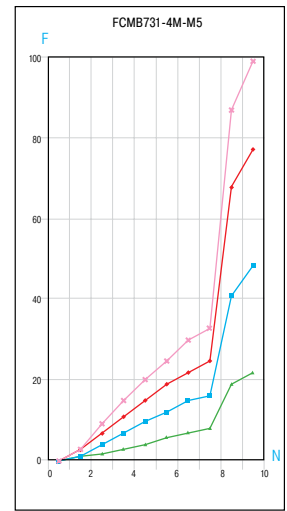
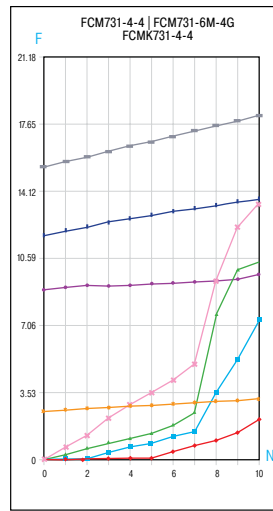
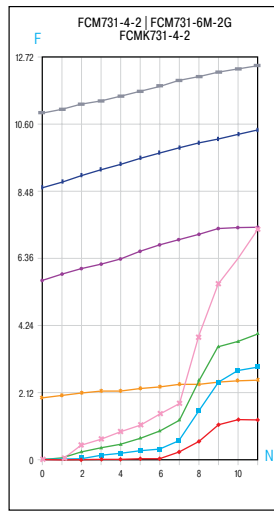
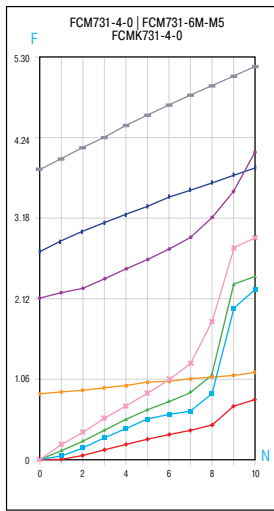

— Controlled Direction – 14.5 PSI (0.9 bar) — Controlled Direction – 43.5 PSI (2.9 bar)
— Controlled Direction – 72.5 PSI (4.9 bar) — Controlled Direction – 101.5 PSI (6.9 bar)
— Return Direction – 14.5 PSI (0.9 bar) — Return Direction – 43.5 PSI (2.9 bar)
— Return Direction – 72.5 PSI (4.9 bar) — Return Direction – 101.5 PSI (6.9 bar)



87 PSI (5.9 bar) ■ Return Direction ■ Controlled Direction ■ N = Number of Turns F = Flow in SCFM

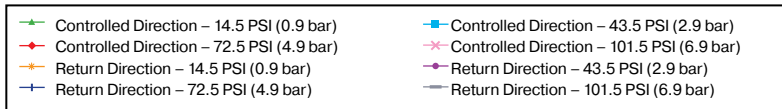
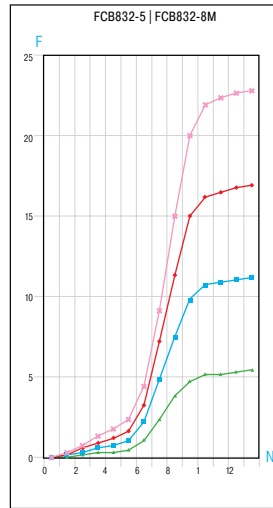
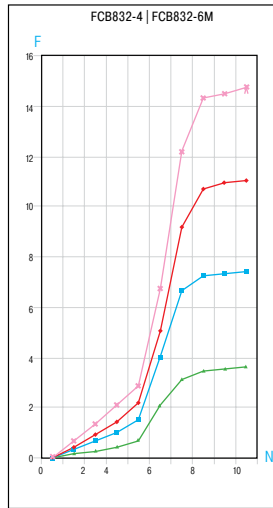
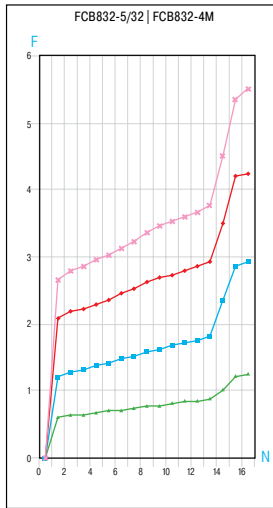
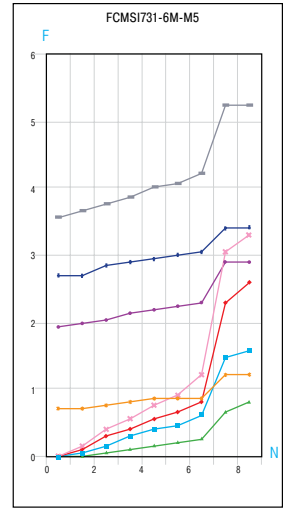
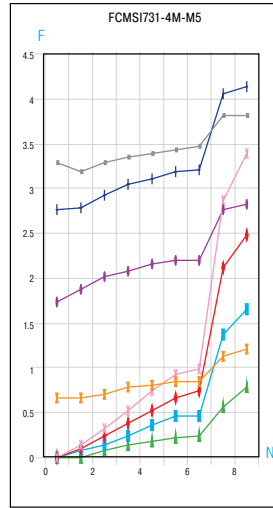
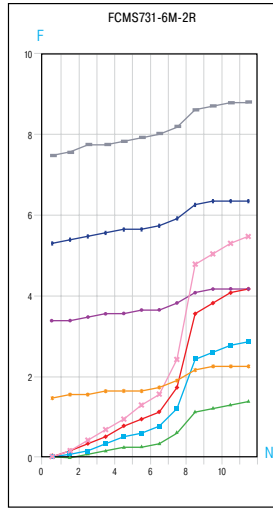
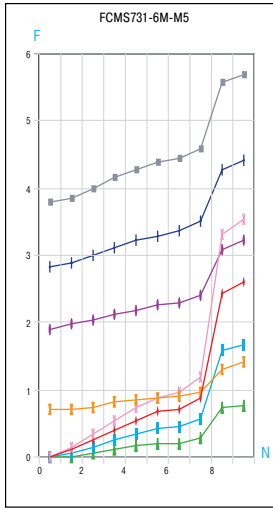

- A
- B
- C
- D
- E
- F
- G
- H
- I
- J
- K
- L
- M
- N
- O

Flare and Thread Profiles

SAE (JIC) 37° Flare Nose Sizes

Actual Size

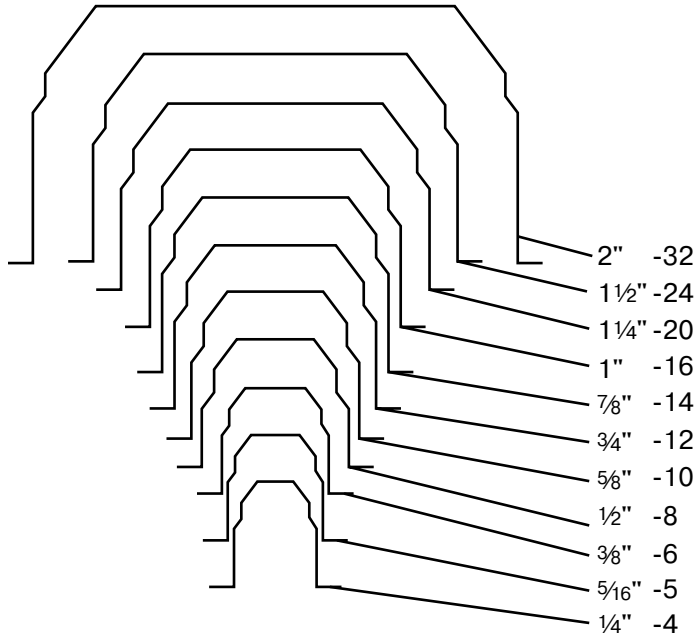

SAE 45° Flare Nose Sizes

Actual Size

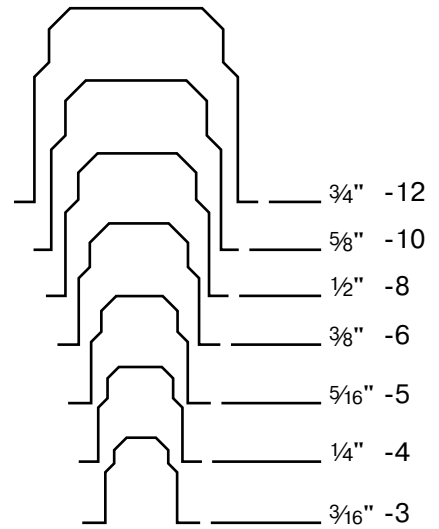

Male Pipe Thread Sizes

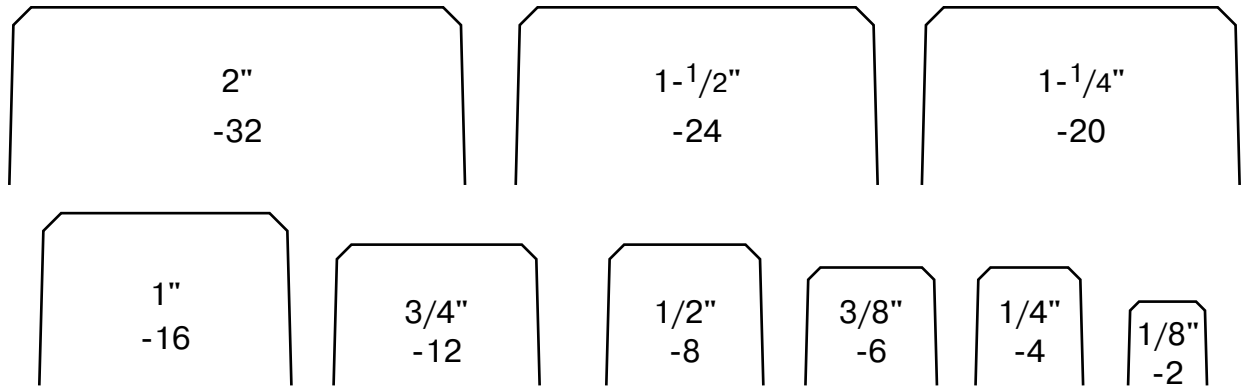

Actual Outside Diameters of Tubing

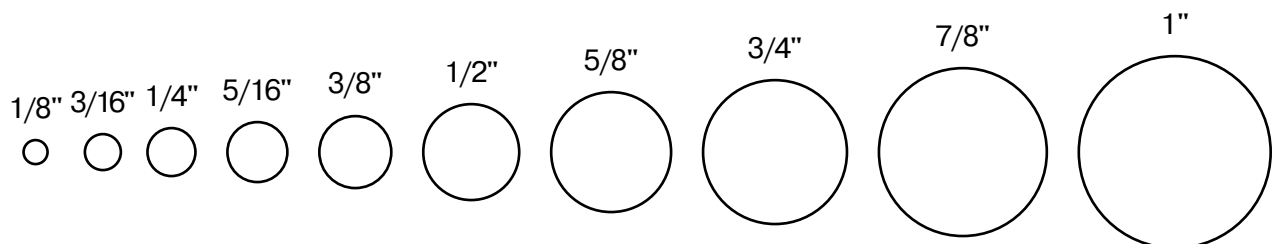

Pressure Conversions

| KILOPASCALS (KPA) | MEGAPASCALS (MPA) | BAR (bar) | KILOGRAMS PER SQUARE CENTIMETER (KGF/CM2) | POUNDS PER SQUARE INCH (PSI) |
|-------------------|-------------------|-----------|---|------------------------------|
| 100 | 1.0 | 1 | 1.02 | 14.50 |
| 200 | .2 | 2 | 2.04 | 29.00 |
| 300 | .3 | 3 | 3.06 | 43.50 |
| 400 | .4 | 4 | 4.08 | 58.00 |
| 500 | .5 | 5 | 5.10 | 72.50 |
| 600 | .6 | 6 | 6.12 | 87.00 |
| 700 | .7 | 7 | 7.14 | 101.50 |
| 800 | .8 | 8 | 8.16 | 116.00 |
| 900 | .9 | 9 | 9.18 | 130.50 |
| 1000 | 1.0 | 10 | 10.20 | 145.00 |
| 2000 | 2.0 | 20 | 20.40 | 290.10 |
| 3000 | 3.0 | 30 | 30.60 | 435.10 |
| 4000 | 4.0 | 40 | 40.80 | 580.20 |
| 5000 | 5.0 | 50 | 51.00 | 725.20 |
| 6000 | 6.0 | 60 | 61.20 | 870.20 |
| 7000 | 7.0 | 70 | 71.40 | 1015.30 |
| 8000 | 8.0 | 80 | 81.60 | 1160.30 |
| 9000 | 9.0 | 90 | 91.80 | 1305.30 |
| 10000 | 10.0 | 100 | 102.00 | 1450.00 |
| 20000 | 20.0 | 200 | 204.00 | 2901.00 |
| 30000 | 30.0 | 300 | 306.00 | 4351.00 |
| 40000 | 40.0 | 400 | 408.00 | 5802.00 |
| 50000 | 50.0 | 500 | 510.00 | 7252.00 |
| 60000 | 60.0 | 600 | 612.00 | 8702.00 |
| 70000 | 70.0 | 700 | 714.00 | 10153.00 |
| 80000 | 80.0 | 800 | 816.00 | 11603.00 |
| 90000 | 90.0 | 900 | 918.00 | 13053.00 |
| 100000 | 100.0 | 1000 | 1020.00 | 14504.00 |
| 200000 | 100.0 | 2000 | 2040.00 | 29008.00 |
| 300000 | 300.0 | 3000 | 3060.00 | 43511.00 |
| | | | | |

| POUNDS PER SQUARE INCH (PSI) | KILOPASCALS (KPA) | MEGAPASCALS (MPA) | BAR (bar) | KILOGRAMS PER SQUARE CENTIMETER (KGF/CM2) |
|------------------------------|-------------------|-------------------|-----------|---|
| 10 | 68.90 | .07 | .70 | .70 |
| 20 | 137.90 | .14 | 1.41 | 1.41 |
| 30 | 206.80 | .21 | 2.10 | 2.11 |
| 40 | 275.80 | .28 | 2.80 | 2.81 |
| 50 | 344.70 | .34 | 3.40 | 3.52 |
| 60 | 413.70 | .41 | 4.10 | 4.22 |
| 70 | 482.60 | .48 | 4.80 | 4.92 |
| 80 | 551.60 | .55 | 5.50 | 5.63 |
| 90 | 620.50 | .62 | 6.20 | 6.33 |
| 100 | 689.00 | .70 | 6.90 | 7.00 |
| 200 | 1379.00 | 1.40 | 13.80 | 14.10 |
| 300 | 2068.00 | 2.10 | 20.70 | 21.10 |
| 400 | 2758.00 | 2.80 | 27.60 | 28.10 |
| 500 | 3447.00 | 3.40 | 34.50 | 35.20 |
| 600 | 4137.00 | 4.10 | 41.40 | 42.20 |
| 700 | 4826.00 | 4.80 | 48.30 | 49.20 |
| 800 | 5516.00 | 5.50 | 55.20 | 56.30 |
| 900 | 6205.00 | 6.20 | 62.10 | 63.30 |
| 1000 | 6895.00 | 6.90 | 68.90 | 70.30 |
| 2000 | 13790.00 | 13.80 | 137.90 | 140.70 |
| 3000 | 20684.00 | 20.70 | 206.80 | 211.00 |
| 4000 | 27579.00 | 27.60 | 275.80 | 281.30 |
| 5000 | 34474.00 | 34.50 | 344.70 | 351.60 |
| 6000 | 41369.00 | 41.40 | 413.70 | 421.90 |
| 7000 | 48263.00 | 48.30 | 482.60 | 492.30 |
| 8000 | 55158.00 | 55.20 | 551.60 | 562.60 |
| 9000 | 62053.00 | 62.10 | 620.50 | 632.90 |
| 10000 | 68948.00 | 68.90 | 689.00 | 703.00 |
| 20000 | 137895.00 | 137.90 | 1379.00 | 1406.00 |
| 30000 | 206843.00 | 206.80 | 2068.00 | 2110.00 |
| 40000 | 275790.00 | 275.80 | 2758.00 | 2813.00 |

- A
- B
- C
- D
- E
- F
- G
- H
- I
- J
- K
- L
- M
- N
- O



Tube Insertion Depths

This engineering standard covers the tube insertion depths and minimum depths to pass thru the o-ring. The depths are used for conveying information to customers and are meant to be used only as a guideline.



Brass Prestolok Plus (PLP Metal)

| TUBE SIZE | FULL INSERTION DEPTH (IN.) | MINIMUM O-RING DEPTH (IN.) |
|-----------|----------------------------|----------------------------|
| 1/8" | .64 | .48 |
| 5/32" | .64 | .48 |
| 3/16" | .67 | .48 |
| 1/4" | .67 | .49 |
| 5/16" | .77 | .51 |
| 3/8" | .78 | .51 |
| 1/2" | .85 | .58 |

LF3000 (PLP Composite) & LIQUIfit

| TUBE SIZE | FULL INSERTION DEPTH (IN.) | MINIMUM O-RING DEPTH (IN.) |
|-----------|----------------------------|----------------------------|
| 1/8" | .46 | .38 |
| 3/16" | .65 | .56 |
| 1/4" | .58 | .44 |
| 3/8" | .81 | .62 |
| 1/2" | 1.09 | .84 |
| 4MM | .51 | .39 |
| 6MM | .58 | .45 |
| 8MM | .73 | .55 |
| 10MM | .81 | .62 |
| 12MM | .97 | .73 |
| 14MM | 1.08 | .83 |
| 16MM | 1.15 | .89 |

LF3600 (PLM) & LF3800 (PLS)

| TUBE SIZE | FULL INSERTION DEPTH (IN.) | MINIMUM O-RING DEPTH (IN.) |
|-----------|----------------------------|----------------------------|
| 1/4" | .66 | .55 |
| 3/8" | .88 | .73 |
| 1/2" | .89 | .74 |
| 4MM | .57 | .49 |
| 6MM | .68 | .57 |
| 8MM | .71 | .62 |
| 10MM | .90 | .75 |
| 12MM | .96 | .78 |
| 14MM | 1.00 | .82 |

Carstick

| TUBE SIZE | FULL INSERTION DEPTH (IN.) | MINIMUM O-RING DEPTH (IN.) |
|-----------|----------------------------|----------------------------|
| 1/8" | .46 | .38 |
| 1/4" | .75 | .55 |
| 3/8" | .86 | .68 |
| 1/2" | 1.16 | .92 |
| 4MM | .49 | .41 |
| 6MM | .58 | .49 |
| 8MM | .71 | .60 |
| 10MM | .85 | .67 |
| 12MM | 1.00 | .79 |

Composite PTC

| TUBE SIZE | FULL INSERTION DEPTH (IN.) | MINIMUM O-RING DEPTH (IN.) |
|-----------|----------------------------|----------------------------|
| 1/4" | .58 | .47 |
| 3/8" | .70 | .53 |
| 1/2" | .80 | .61 |
| 5/8" | .99 | .72 |
| 3/4" | 1.04 | .83 |

PMTCE

| TUBE SIZE | FULL INSERTION DEPTH (IN.) | MINIMUM O-RING DEPTH (IN.) |
|-----------|----------------------------|----------------------------|
| 1/4" | .65 | .54 |
| 3/8" | .81 | .72 |
| 1/2" | .94 | .72 |
| 5/8" | 1.00 | .75 |
| 3/4" | 1.00 | .75 |

Brass PTC

| TUBE SIZE | FULL INSERTION DEPTH (IN.) | MINIMUM O-RING DEPTH (IN.) |
|-----------|----------------------------|----------------------------|
| 5/32" | .64 | .44 |
| 3/16" | .62 | .44 |
| 1/4" | .59 | .49 |
| 3/8" | .78 | .56 |
| 1/2" | .85 | .63 |
| 5/8" | 1.02 | .80 |
| 3/4" | 1.03 | .82 |

TrueSeal – Acetal & Kynar

| TUBE SIZE | FULL INSERTION DEPTH (IN.) | MINIMUM O-RING DEPTH (IN.) |
|-----------|----------------------------|----------------------------|
| 1/4" | .71 | .52 |
| 5/16" | .80 | .55 |
| 3/8" | .80 | .55 |
| 1/2" | .90 | .63 |

TrueSeal - PolyPropylene

| TUBE SIZE | FULL INSERTION DEPTH (IN.) | MINIMUM O-RING DEPTH (IN.) |
|-----------|----------------------------|----------------------------|
| 1/4" | .74 | .55 |
| 3/8" | .83 | .59 |
| 1/2" | .93 | .66 |

Metric Prestomatic

| TUBE SIZE | FULL INSERTION DEPTH (IN.) | MINIMUM O-RING DEPTH (IN.) |
|-----------|----------------------------|----------------------------|
| 6MM | .78 | |
| 8MM | .80 | |
| 10MM | .91 | |
| 12MM | .91 | |
| 16MM | .89 | |

LF3800 (PLS)

| TUBE SIZE | FULL INSERTION DEPTH (IN.) | MINIMUM O-RING DEPTH (IN.) |
|-----------|----------------------------|----------------------------|
| 1/4" | .69 | .58 |
| 3/16" | .57 | .49 |
| 3/8" | .90 | .75 |
| 1/2" | .93 | .78 |
| 4MM | .57 | .49 |
| 6MM | .67 | .56 |
| 8MM | .74 | .65 |
| 10MM | .91 | .76 |
| 12MM | .96 | .79 |

Prestomatic

| TUBE SIZE | FULL INSERTION DEPTH (IN.) | MINIMUM O-RING DEPTH (IN.) |
|-----------|----------------------------|----------------------------|
| 1/4" | .63 | .54 |
| 3/8" | .81 | .72 |
| 1/2" | .94 | .72 |
| 5/8" | 1.12 | .75 |
| 3/4" | 1.12 | .92 |



English/Metric Conversions

Inches x 25.4 = Millimeters (mm)
 Inches x 2.54 = Centimeters (cm)
 Inches x .254 = Decimeters (dm)
 Feet x .3048 = Meters (m)
 Yards x .9144 = Meters (m)
 PSI x .0689 = Bars (bar)
 Bars x 100 = Kilopascals (kPa)
 PSI x .0069 = Megapascals (MPa)
 Pound Inches x .113 = Newton Meters (N·m)

Pound Feet x 1.356 = Newton Meters (N·m)
 Millimeters x .0394 = Inches
 Centimeters x .3937 = Inches
 Meters x 3.281 = Feet
 Meters x 1.0936 = Yards
 Bars x 14.5 = PSI Megapascals x 145 = PSI
 Newton Meters x 8.85 = Pound Inches
 Newton Meters x .737 = Pound Feet

Millimeters to Fractions to Decimals

| MM | INCHES | |
|--------|----------|---------|
| | FRACTION | DECIMAL |
| .3969 | 1/64 | .0156 |
| .7938 | 1/32 | .0312 |
| 1.1906 | 3/64 | .0468 |
| 1.5875 | 1/16 | .0625 |
| 1.9844 | 5/64 | .0781 |
| 2.3812 | 3/32 | .0937 |
| 2.7781 | 7/64 | .1093 |
| 3.1750 | 1/8 | .1250 |
| 3.5719 | 9/64 | .1406 |
| 3.9688 | 5/32 | .1562 |
| 4.3656 | 11/64 | .1718 |
| 4.7625 | 3/16 | .1875 |
| 5.1594 | 13/64 | .2031 |
| 5.5562 | 7/32 | .2187 |
| 5.9531 | 15/64 | .2343 |
| 6.3500 | 1/4 | .2500 |

| MM | INCHES | |
|---------|----------|---------|
| | FRACTION | DECIMAL |
| 6.7469 | 17/64 | .2656 |
| 7.1438 | 9/32 | .2812 |
| 7.5406 | 19/64 | .2968 |
| 7.9375 | 5/16 | .3125 |
| 8.3344 | 21/64 | .3281 |
| 8.7312 | 11/32 | .3437 |
| 9.1281 | 23/64 | .3593 |
| 9.5250 | 3/8 | .3750 |
| 9.9219 | 25/64 | .3906 |
| 10.3188 | 13/32 | .4062 |
| 10.7156 | 27/64 | .4218 |
| 11.1125 | 7/16 | .4375 |
| 11.5094 | 29/64 | .4531 |
| 11.9062 | 15/32 | .4687 |
| 12.3031 | 31/64 | .4843 |
| 12.7000 | 1/2 | .5000 |

| MM | INCH | |
|---------|----------|---------|
| | FRACTION | DECIMAL |
| 13.0969 | 33/64 | .5156 |
| 13.4938 | 17/32 | .5312 |
| 13.8906 | 35/61 | .5468 |
| 14.2875 | 9/16 | .5625 |
| 14.6844 | 37/64 | .5781 |
| 15.0812 | 19/32 | .5937 |
| 14.4781 | 39/64 | .6093 |
| 15.8750 | 5/8 | .6250 |
| 16.2719 | 41/64 | .6406 |
| 16.6688 | 21/32 | .6562 |
| 17.0656 | 43/64 | .6718 |
| 17.4625 | 11/16 | .6875 |
| 17.8594 | 45/64 | .7031 |
| 18.2562 | 23/32 | .7187 |
| 18.6531 | 47/64 | .7343 |
| 19.0500 | 3/4 | .7500 |

| MM | INCH | |
|---------|----------|---------|
| | FRACTION | DECIMAL |
| 19.4469 | 49/64 | .7656 |
| 19.8438 | 25/32 | .7812 |
| 20.2406 | 51/64 | .7968 |
| 20.2375 | 13/16 | .8125 |
| 21.0344 | 53/64 | .8281 |
| 21.4312 | 27/32 | .8437 |
| 21.8281 | 55/64 | .8593 |
| 22.2250 | 7/8 | .8750 |
| 22.6219 | 57/64 | .8906 |
| 23.0188 | 29/32 | .9062 |
| 23.4156 | 59/64 | .9218 |
| 23.8125 | 15/16 | .9375 |
| 24.2094 | 61/64 | .9531 |
| 24.6062 | 31/32 | .9687 |
| 25.0031 | 63/64 | .9843 |
| 25.4000 | 1 | 1.0000 |

Assembly Guides

A

B

C

D

E

F

G

H

I

J

K

L

M

N

O

Push-to-Connect Fittings

- Prestolok PLP Metal
- Prestolok PLP Composite
- Prestolok PLM
- Prestolok PLS
- Oscillating Elbows
- LIQUIFit
- TrueSeal
- Flow Controls
- Prestomatic
- PTC
- Metric Prestomatic
- PMH
- Polypropylene Ball Valves

1. Cut tubing squarely – maximum of 15° angle allowable.
2. Check that port or mating part is clean and free of debris.
3. Mark tubing to appropriate tube insertion length. (see Tube Insertion Chart on page N22)
4. Insert tubing until it bottoms
5. Pull on tubing to verify it is fully inserted
6. To disassemble, simply press release button, hold against body and pull tubing out of fitting.



Transportation Compression Style NTA

1. Cut tubing squarely – maximum of 15° angle allowable.
2. Check that port or mating part is clean and free of debris.
3. Insert tubing until it bottoms on seat.
4. Tighten nut with wrench until one thread remains visible on the fitting body; (this will allow for a number of remakes) or, the nut should be screwed down finger tight, then wrench-tightened as indicated in the following table.

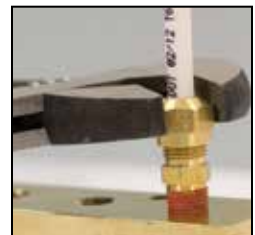

| TUBE SIZE | ADDITIONAL NUMBER OF TURNS FROM HAND-TIGHT |
|-----------|--|
| 3/16 | 2-1/2 |
| 1/4 | 3 |
| 3/8 & 1/2 | 4 |
| 5/8 & 3/4 | 3-1/2 |

Air Brake – AB Fittings

1. Cut tubing squarely and remove burrs
2. Slide nut and sleeve onto tubing.
3. Insert tubing into fitting until bottomed on seat. The nut should be screwed down finger tight, then wrench tightened as indicated in the chart



| TUBE SIZE | TURNS REQUIRED TO SEAL FROM HAND-TIGHT |
|---------------|--|
| 1/4, 3/8, 1/2 | 2 |
| 5/8, 3/4 | 3 |

Transmission Fittings

1. Cut tubing squarely and remove burrs
2. Insert tubing into fitting until bottomed
3. Tighten nut 1 1/2 turns from finger tight



Vibra-Lok

1. Cut the tubing squarely removing burrs
2. Slip nut and sleeve over tube
3. Bottom tubing into fitting and tighten nut until stop is reached. The elastic sleeve ordinarily will extrude slightly around the tube at the end of the nut. This extrusion further aids in isolating the tube from the nut.



For Higher Pressure applications

4. Consult pressure chart to determine if tubing should be belled
5. Slip nut and sleeve over tube. The sleeve should be positioned near end of tubing just behind the surface to be belled
6. Bell tubing with standard 45° flaring tool or 90° punch. The size of bell should be approximately that shown.



Air Brake Hose Ends

1. Slide nut onto hose
2. Slide sleeve onto hose with tapered edge toward fitting body
3. Bottom hose into fitting
4. Tighten nut until it contacts body hex



Note: When reassembling fitting, body and nut should be inspected. Only reuse if parts are in proper condition. Sleeves should never be Reused.

Recommended Size of Bell

| TUBE O.D. | BELL DIA. C |
|-----------|-------------|
| 1/8 | .190-.160 |
| 3/16 | .255-.225 |
| 1/4 | .318-.288 |
| 5/16 | .381-.351 |
| 3/8 | .444-.414 |
| 1/2 | .569-.539 |
| 5/8 | .694-.664 |
| 3/4 | .819-.789 |
| 7/8 | .944-.914 |

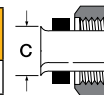

Tube Length Calculator

This table shows distance tube extends beyond face of Vibra-Lok fitting body on installation with bell on tubing and without bell on tubing.

| O.D. OF TUBE | A WITH BELL | B WITHOUT BELL |
|--------------|-------------|-------------------------|
| 1/8 | 3/16 | 3/16 |
| 3/16 | 3/16 | 7/32 |
| 1/4 | 3/16 | 1/4 |
| 5/16 | 3/16 | 1/4 |
| 3/8 | 3/16 | 1/4 |
| 1/2 | 3/16 | 11/32 |
| 5/8 | 3/16 | TUBING SHOULD BE BELLED |
| 3/4 | 3/16 | |
| 7/8 | 1/4 | |

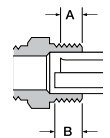

A

B

C

D

E

F

G

H

I

J

K

L

M

N

O

Compression

1. Slide nut then sleeve onto tubing. The thread end of the nut must face out.
2. Insert tube and bottom on the fitting shoulder
3. Assemble nut to body and tighten “hand tight”. Then wrench tighten the number of turns indicated in the table.



| FITTING SIZE | TUBE SIZE | TURNS REQUIRED TO SEAL FROM HAND-TIGHT | |
|--------------|-----------|--|--------------------------------|
| | | 60C WITH SOFT METAL TUBING | 60PT WITH THERMOPLASTIC TUBING |
| 2 | 1/8 | 1-1/4 | -- |
| 3 | 3/16 | 1-1/4 | -- |
| 4 | 1/4 | 1-1/4 | 2 |
| 5 | 5/16 | 1-1/4 | 2 |
| 6 | 3/8 | 2-1/4 | 2 |
| 8 | 1/2 | 2-1/4 | 2 |
| 10 | 5/8 | 2-1/4 | 2 |
| 12 | 3/4 | 2-1/4 | 2 |
| 14 | 7/8 | 2-1/4 | -- |

Compress-Align

With nut finger tight on fitting body, insert tubing until it bottoms in the Fitting. Complete the seal with one wrench turn for all sizes.



Poly-Tite

1. Cut tubing squarely – maximum of 15° angle allowable.
2. Check that port or mating part is clean and free of debris.
3. Insert tube end until it bottoms in the Poly-Tite fitting and tighten knurl/hex nut finger-tight, plus one wrench turn.

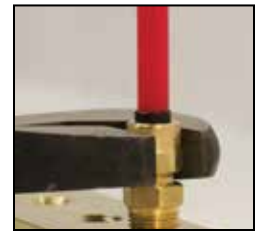

Hi-Duty

1. Cut tube squarely and cleanly removing all burrs.
2. Grasp fitting. Do not remove nut.
3. Insert tube in fitting through nut until tube seats firmly against tube shoulder in body.
4. Grip tube firmly to prevent turning and tighten nut to finger-tight. Continue to tighten for one and three-quarter additional turns (one and one-half turns for 1/2” size fittings) for a positive, leak proof seal. During tightening a slight “give” will be felt. This “give” indicates the sleeve has been sheared from the nut. It is not necessary to tighten the nut all the way down.



45° Flare Fittings

1. Cut tubing squarely and clean tube end thoroughly to remove burrs.
2. Place nut onto tube. Place threaded end of nut toward end of tube.
3. Flare tube end with flaring tool to provide 45° flare.
4. Clamp tube flare between nut and nose of fitting body by screwing nut on finger-tight. Tighten with a wrench an additional 1/4 to 1/2 turn past finger-tight for a metal-to-metal seal.

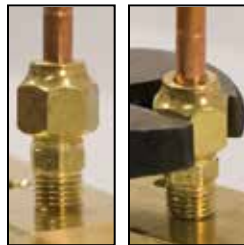

Inverted Flare

1. Cut tubing squarely and clean to remove burrs
2. Place nut onto tube. Place threaded end of nut toward end of tube.
3. Flare tube end with flaring tool to provide 45° flare
4. On thin wall copper, welded or brazed tubing, use double flare to prevent pinch-off or cracked flares
5. Clamp tube flare between nut and nose of fitting body by screwing nut on finger tight. Tighten nut with a wrench an additional 1/4 to 1/2 turn past finger tight for a metal-to-metal seal.



Dubl-Barb

Cut tube squarely and simply push tube over the two barbs



Hose Barbs

1. Cut hose cleanly and squarely to length.
2. Slide clamp on hose.
3. Lubricate hose. Push hose on fitting until bottomed against stop ring or hex.
4. Position hose clamp as shown and secure with a screwdriver or wrench. Maintain "A" dimension for proper clamp positioning.



| HOSE SIZE | HOSE CLAMP | A |
|-----------|------------|-----|
| 3/16 | 97 HC-3 | 1/4 |
| 1/4 | 97 HC-3 | 1/4 |
| 5/16 | 97 HC-6 | 1/4 |
| 3/8 | 97 HC-6 | 1/8 |
| 1/2 | 97 HC-8 | 1/8 |
| 5/8 | 97 HC-12 | 1/8 |
| 3/4 | 97 HC-12 | 1/8 |

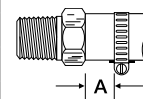

- A
- B
- C
- D
- E
- F
- G
- H
- I
- J
- K
- L
- M
- N
- O

- A
- B
- C
- D
- E
- F
- G
- H
- I
- J
- K
- L
- M
- N
- O

Pipe Fittings

Straight Fittings

1. Hand tighten external thread into internal thread
2. Tighten an additional 2 turns with a wrench up to 1/2" male pipe thread.
3. Above 1/2" 1 1/2 to 2 1/2 turns.

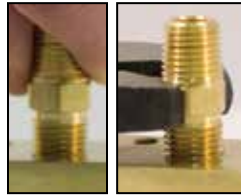

Elbow or Tee Fittings

1. Hand tighten external thread into internal thread
2. Tighten an additional 1 to 1 1/2 turns with a wrench
3. Tighten fitting, clockwise to align with tubing. (Never counter clockwise)

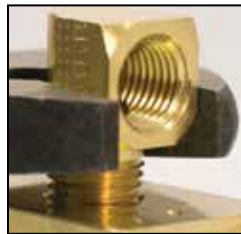

Note: To minimize the possibility of a leaking threaded joint after assembling Male to female pipe threads, neither end should be backed out (loosened) Once the assembly has been made.

Plug Valves

To assure sealability and reliable performance, the valve must be installed So that the flow media travels in the direction of the arrow on the valve handle.



Needle Valves

Needle valves should always be installed with the pressure against the seat.

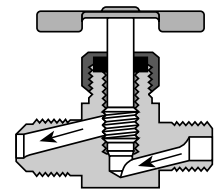

NEMA Rated Bulkhead

1. Drill panel to required diameter
2. Install sealing washer onto brass body.
3. Install fitting body through panel and secure with lock washer and jam nut.
4. Using a wrench to hold the fitting body torque the jam nut to spec per below table.

Note: For sealing bulkheads the sealing washer must be installed between the body hex and panel. To ensure a leak tight connection the panel surface must be kept flat and deburred after the drilling operation. It must be free from dirt, debris, and other contamination.

| THREAD SIZE | MIN. TORQUE FT-LBS | MAX. TORQUE FT-LBS |
|-------------|--------------------|--------------------|
| 5/8-18 | 15 | 20 |
| 3/4-16 | 15 | 25 |
| 1-14 | 40 | 50 |

Fluid Compatibility Guide

The following pages list general recommendations for the selection of valve materials. For specific cases, and for those not included in the Fluid Compatibility Chart, it is advisable to check with your Parker representative.

There are many specific environmental factors which might affect corrosion rate such as temperature, solution, concentration and presence of impurities. Therefore, we suggest that the information be used as a rough guide to material selection. If any questions exist regarding the expected performance of a material in a given application, actual tests should be performed to determine the suitability of the materials in question.

| FLUID | BRASS | CARBON STEEL | 216 S.S. | BUNA N (NITRILE) | NEO-PRENE | EPR | FLUORO-CARBON | PTFE | ACETAL | NYLON |
|----------------------------|-------|--------------|----------|------------------|-----------|-----|---------------|------|--------|-------|
| ACETALDEHYDE | P | G | E | P | G | G | P | E | U | |
| ACETAMINE | G | G | G | E | G | | | E | | |
| ACETATE SOLVENTS | E | E | E | P | | | U | E | U | |
| ACETIC ACID VAPORS | U | | U | U | | | | E | | |
| ACETIC ACID (10%) | P | P | E | U | P | G | U | E | U | U |
| ACETIC ACID (80%) | P | P | E | U | U | P | U | E | U | U |
| ACETIC ACID (AERATED) | P | P | E | G | G | | P | E | U | |
| ACETIC ACID (AIR FREE) | P | P | E | G | G | | U | E | U | |
| ACETIC ACID (CRUDE) | P | P | E | U | U | | U | E | U | |
| ACETIC ACID (GLACIAL) | | | U | U | P | G | P | E | | U |
| ACETIC ACID (PURE) | P | U | E | U | U | | U | E | U | |
| ACETIC ANHYDRIDE | U | U | G | U | P | P | U | E | U | U |
| ACETONE | E | E | E | U | U | E | U | E | E | E |
| ACETOPHENONE | G | G | G | U | U | E | U | | | |
| ACETYL CHLORIDE | E | G | P | U | U | U | U | E | | |
| ACETYLENE | G | E | E | G | P | E | E | E | E | |
| ACID FUMES | U | U | G | P | G | | | E | | |
| ACRYLONITE | E | E | E | U | U | U | P | E | | |
| AIR | E | E | E | E | E | E | E | E | E | |
| ALCOHOL, AMYL | G | G | E | P | P | E | G | E | E | |
| ALCOHOL, BUTYL | G | G | E | G | G | P | E | E | E | |
| ALCOHOL, DIACETONE | E | E | E | U | P | G | U | E | | |
| ALCOHOL, ETHYL | G | G | G | E | G | E | E | E | E | |
| ALCOHOL, ISOPROPYL | G | G | G | P | G | E | E | E | E | |
| ALCOHOL, METHYL | E | G | E | G | E | E | P | E | E | |
| ALCOHOL, PROPYL | E | G | E | G | G | E | E | E | | |
| ALCOHOLS, FATTY | G | G | E | G | G | | | E | | |
| ALUM | U | | G | G | G | | G | E | | |
| ALUMINA | U | | E | E | E | E | | E | | |
| ALUMINUM ACETATE | G | | E | U | U | E | U | E | | |
| ALUMINUM BROMIDE | | | | E | E | E | E | | | |
| ALUMINUM CHLORIDE DRY | U | P | P | G | G | E | E | E | E | |
| ALUMINUM CHLORIDE SOLUTION | | | U | G | G | | E | E | | U |
| ALUMINUM FLUORIDE | U | U | P | E | E | E | E | E | | U |
| ALUMINUM HYDROXIDE | E | U | E | E | E | E | E | E | | |
| ALUMINUM NITRATE | U | U | P | G | G | G | U | E | | |
| ALUMINUM OXALATE | | | U | | | | | E | | |
| ALUMINUM SALTS | | | | E | E | E | E | | | |
| ALUMINUM SULFATE | P | U | G | E | E | E | E | E | E | P |
| AMINES | G | G | E | U | U | P | U | E | E | |

E-EXCELLENT

G-GOOD

P-POOR

U-UNSATISFACTORY



A
B
C
D
E
F
G
H
I
J
K
L
M
N
O

| FLUID | BRASS | CARBON STEEL | 216 S.S. | BUNA N (NITRILE) | NEO-PRENE | EPR | FLUORO-CARBON | PTFE | ACETAL | NYLON |
|------------------------------|-------|--------------|----------|------------------|-----------|-----|---------------|------|--------|-------|
| AMYLCHLORIDE | G | | E | U | P | U | U | E | | |
| AMMONIUM BICARBONATE | G | P | G | G | E | E | E | E | E | |
| AMMONIA, ALUM | | | E | G | G | | | E | | |
| AMMONIA, ANHYDROUS LIQUID | U | E | E | G | P | G | U | E | | |
| AMMONIA, AQUEOUS | U | E | E | G | G | | E | E | | |
| AMMONIA, GAS, HOT | U | G | E | P | E | E | U | E | | |
| AMMONIA LIQUOR | | | E | | | | | E | | |
| AMMONIA SOLUTIONS | U | G | E | G | G | G | U | E | | |
| AMMONIUM ACETATE | U | | G | G | G | E | U | E | | |
| AMMONIUM BROMIDE 5% | | | G | | | | | E | | |
| AMMONIUM CARBONATE | G | G | G | P | E | E | G | E | E | |
| AMMONIUM CHLORIDE | U | U | P | G | E | E | E | E | E | U |
| AMMONIUM HYDROXIDE 28% | U | P | G | G | E | G | E | E | | |
| AMMONIUM HYDROXIDE CONC. | U | P | G | P | E | E | E | E | E | |
| AMMONIUM MONOSULFATE | | | E | | | | | E | | |
| AMMONIUM NITRATE | U | U | E | E | E | E | E | E | E | U |
| AMMONIUM OXALATE 5% | | | E | | | | | E | | |
| AMMONIUM PERSULFATE | P | U | E | U | P | G | G | E | | U |
| AMMONIUM PHOSPHATE | U | U | G | E | E | E | E | E | G | P |
| AMMONIUM PHOSPHATE DI-BASIC | P | U | G | E | E | | E | E | E | |
| AMMONIUM PHOSPHATE TRI-BASIC | P | U | G | E | E | | E | E | E | |
| AMMONIUM SULFATE | P | P | G | E | E | E | G | E | E | U |
| AMMONIUM SULFIDE | U | U | G | E | G | E | U | E | | |
| AMMONIUM SULFITE | P | P | E | G | E | G | E | E | E | |
| AMYL ACETATE | G | P | G | U | U | G | U | E | G | P |
| AMYL BORATE | | | | E | E | U | E | | | |
| AMYL CHLORONAPHTHALENE | | | | U | U | U | E | | | |
| AMYL NAPHTHALENE | | | | U | U | U | E | | | |
| ANILINE | U | P | G | U | U | P | P | E | E | P |
| ANILINE DYES | P | P | E | P | P | P | G | E | E | |
| ANIMAL OIL | G | G | G | E | G | G | E | | | |
| ANTIMONY TRICHLORIDE | U | U | U | P | | | G | E | | |
| APPLE JUICE | P | U | G | E | E | G | E | E | | |
| AQUA REGIA (STRONG ACID) | U | U | G | U | U | U | U | E | | U |
| AROCLOR 1248 | G | U | U | U | U | G | E | | | |
| AROCLOR 1254 | G | U | U | U | U | G | E | | | |
| AROCLOR 1260 | G | U | U | E | E | | E | | | |
| AROMATIC SOLVENTS | E | P | E | U | U | U | | E | | |
| ARSENIC ACID | U | U | G | E | E | G | E | E | E | U |
| ASPHALT EMULSION | E | G | E | U | P | U | E | E | E | |
| ASPHALT LIQUID | E | G | E | P | P | U | E | E | E | |
| ASTM OIL, NO. 1 | E | E | E | E | E | U | E | | | |
| ASTM OIL, NO. 2 | E | E | E | E | E | G | U | E | | |
| ASTM OIL, NO. 3 | E | E | E | E | U | U | E | | | |
| ASTM OIL, NO. 4 | E | E | E | G | U | U | E | | | |
| ASTM REFERENCE FUEL A | U | G | E | E | G | U | E | | | |
| ASTM REFERENCE FUEL B | U | G | E | E | U | U | E | | | |
| ASTM REFERENCE FUEL C | U | G | E | G | U | U | E | | | |
| BARIUM CARBONATE | G | G | G | G | E | E | E | E | E | |
| BARIUM CHLORIDE | G | P | G | E | E | E | E | E | E | E |
| BARIUM CYANIDE | P | | G | G | G | G | G | E | | |
| BARIUM HYDRATE | U | | E | | | | | E | | |
| BARIUM HYDROXIDE | P | P | G | E | E | G | E | E | E | |
| BARIUM NITRATE | | | E | | G | | | E | | |
| BARIUM SALTS | | | | E | E | E | E | | | |

E-EXCELLENT

G-GOOD

P-POOR

U-UNSATISFACTORY



| FLUID | BRASS | CARBON STEEL | 216 S.S. | BUNA N (NITRILE) | NEO-PRENE | EPR | FLUORO-CARBON | PTFE | ACETAL | NYLON |
|---------------------------|-------|--------------|----------|------------------|-----------|-----|---------------|------|--------|-------|
| BARIUM SULFATE | P | P | E | E | E | G | E | E | E | E |
| BARIUM SULFIDE | U | P | G | E | G | E | E | E | E | |
| BEER | G | U | E | G | G | G | E | E | E | U |
| BEET SUGAR LIQUORS | E | G | E | E | E | G | E | E | E | |
| BENZALDEHYDE | E | E | E | U | U | E | U | E | E | E |
| BENZENE | G | G | G | U | U | U | G | E | | E |
| BENZENESULFONIC ACID, 10% | U | U | U | U | G | U | E | | | |
| BENZYLCHLORIDE | U | U | G | U | U | U | E | | | |
| BENZOIC ACID | G | U | G | P | P | U | G | E | | P |
| BENZYL ALCOHOL | | U | E | U | G | G | E | | | |
| BERRYLLIUM | G | | G | G | G | G | G | E | | |
| BLEACH LIQUOR | | | | U | G | E | E | | | |
| BLEACHING POWDER WET | G | | P | U | E | G | G | E | | |
| BLOOD | G | | E | G | G | G | G | E | | |
| BORAX | U | P | E | G | U | E | E | E | E | E |
| BORAX LIQUORS | E | P | G | | P | E | E | E | E | |
| BORDEAUX MIXTURE | | | E | | | | | E | | |
| BORIC ACID | P | U | G | G | G | G | E | E | E | G |
| BRAKE FLUID | G | | G | U | P | G | U | E | | |
| BRINES, SATURATED | G | U | G | E | G | E | E | E | E | |
| BROMINE, DRY | G | U | U | U | U | U | G | E | | |
| BROMINE, WET | U | U | U | U | U | | G | E | | |
| BUNKER OILS (FUEL) | G | G | E | G | G | | E | E | E | |
| BUTADIENE | P | G | E | P | P | P | G | U | | |
| BUTANE | E | G | E | G | G | U | E | E | E | |
| BUTTER | G | U | E | G | G | | | E | | |
| BUTTERMILK | U | U | E | E | E | G | E | E | E | |
| BUTYLACETATE | G | | G | U | U | U | U | E | | E |
| BUTYL ALCOHOL | E | P | E | G | G | | G | E | | |
| BUTYL AMINE | G | G | E | U | U | | U | E | | |
| BUTYL BUTYRATE | | | | U | U | E | E | | | |
| BUTYL CARBITOL | E | P | E | U | U | | U | E | | |
| BUTYL CELLOSOLVE | E | P | E | U | U | | G | E | | |
| BUTYL STEARATE | | | | G | U | U | E | | | |
| BUTYLENE | E | E | E | U | U | U | U | E | | |
| BUTYRIC ACID | P | U | G | P | P | P | P | E | E | U |
| CALCINE LIQUORS | | | | E | | E | E | | | |
| CALCIUM ACETATE | | | | G | G | E | U | | | |
| CALCIUM BISULFITE | P | U | G | E | E | U | E | E | E | |
| CALCIUM CARBONATE | P | U | G | E | E | G | E | E | E | |
| CALCIUM CHLORATE | U | | G | G | G | G | G | E | | |
| CALCIUM CHLORIDE | G | P | G | E | E | G | E | E | E | U |
| CALCIUM HYDROXIDE | P | P | G | E | G | E | E | E | E | |
| CALCIUM HYPOCHLORITE | U | U | P | P | P | | E | E | E | U |
| CALCIUM NITRATE | | | G | G | G | G | | E | | |
| CALCIUM PHOSPHATE | P | | G | G | G | G | G | E | | |
| CALCIUM SALTS | | | | E | E | E | E | | | |
| CALCIUM SILICATE | P | | G | G | G | G | G | E | | |
| CALCIUM SULFATE | P | P | G | E | E | G | E | E | E | U |
| CALCIUM SULFIDE | U | U | G | E | E | E | E | | | |
| CALICHE LIQUOR | | G | E | G | G | | | E | | |
| CAMPHOR | P | | G | G | G | G | G | E | | |
| CANE SUGAR LIQUORS | G | G | E | G | G | G | G | E | | |
| CARBOLIC ACID | U | U | G | G | G | G | E | E | U | |
| CARBON BISULFIDE | P | G | G | U | U | U | E | E | E | |

E-EXCELLENT

G-GOOD

P-POOR

U-UNSATISFACTORY



| FLUID | BRASS | CARBON STEEL | 216 S.S. | BUNA N (NITRILE) | NEO-PRENE | EPR | FLUORO-CARBON | PTFE | ACETAL | NYLON |
|---------------------------|-------|--------------|----------|------------------|-----------|-----|---------------|------|--------|-------|
| CARBON DIOXIDE, DRY | E | E | E | P | G | G | G | E | | |
| CARBON DISULFIDE | U | P | E | U | U | | E | E | | |
| CARBON MONOXIDE | E | E | E | G | U | G | G | E | | |
| CARBON TETRACHLORIDE, DRY | P | G | E | U | U | U | G | E | E | |
| CARBON TETRACHLORIDE, WET | U | U | G | U | U | U | G | E | E | |
| CARBONATED BEVERAGE | G | U | G | G | G | G | G | G | E | |
| CARBONATED WATER | G | G | E | E | E | E | E | E | E | |
| CASEIN | P | | | G | G | G | G | G | E | |
| CASTER OIL | E | G | E | E | G | G | E | E | E | |
| CAUSTIC POTASH | | | E | G | G | | | E | | |
| CAUSTIC SODA | | G | E | P | | G | G | E | | |
| CELLULOSE ACETATE | G | | G | U | U | G | U | E | | |
| CELLULUBE | E | P | E | U | U | | U | E | | |
| CHINA WOOD OIL | P | P | E | E | G | U | E | E | E | |
| CHLORACETIC ACID | P | U | U | U | P | | P | E | | U |
| CHLORINATED SOLVENTS | P | P | E | U | U | U | P | E | E | |
| CHLORINATED WATER | U | P | G | E | | E | E | E | U | U |
| CHLORINE, WET | U | U | U | U | U | | | E | | |
| CHLORINE GAS | P | G | G | P | U | U | G | E | E | |
| CHLORO BROMO METHANE | G | U | G | U | U | | G | E | | |
| CHLOROBENZENE, DRY | G | G | E | U | U | U | E | E | E | E |
| CHLOROBUTADIENE | | | | U | U | U | E | | | |
| CHLOROFORM, DRY | G | G | E | U | U | U | G | E | E | U |
| CHLOROPHYLL, DRY | G | | G | G | G | G | G | E | | |
| CHLOROSULFONIC ACID, DRY | P | G | G | U | U | U | U | E | | U |
| CHLOROSULFONIC ACID, WET | U | U | U | U | U | | P | E | | |
| CHLORPHENOL | | | | U | U | U | E | | | |
| CHROME ALUM | P | G | E | G | G | G | G | E | | |
| CHROMIC ACID <50% | U | U | P | U | U | P | P | E | U | U |
| CHROMIC ACID >50% | U | U | P | U | U | P | P | E | U | |
| CHROMIUM SULFATE | P | | G | G | G | G | G | E | | |
| CIDER | | | E | | | | | E | | |
| CITRIC ACID | P | U | G | G | E | G | E | E | | P |
| CITRUS JUICES | G | U | G | E | E | | E | E | E | |
| COCA-COLA SYRUP | | | E | G | G | | G | E | | |
| COCONUT OIL | G | P | G | E | P | E | E | E | E | |
| COFFEE | E | | E | E | E | E | E | G | | |
| COFFEE EXTRACTS, HOT | G | P | E | | | | | E | | |
| COKE OVEN GAS | P | G | E | P | U | U | G | E | | |
| COOKING OIL | G | G | E | E | G | U | E | E | E | |
| COPPER ACETATE | U | U | E | P | P | G | U | E | | |
| COPPER CARBONATE | | | E | | | | | E | | |
| COPPER CHLORIDE | U | U | P | G | G | | E | E | | U |
| COPPER CYANIDE | U | | E | E | E | G | G | E | | E |
| COPPER NITRATE | U | U | G | E | E | G | E | E | E | U |
| COPPER SALTS | | | | | E | E | E | E | | |
| COPPER SULFATE | U | U | G | E | E | E | E | E | E | P |
| CORN OIL | G | P | G | E | P | P | E | E | E | |
| COTTONSEED OIL | G | P | G | E | G | P | G | E | E | |
| CREOSOTE OIL | G | G | G | P | U | U | E | E | U | |
| CREOSOLS | U | G | G | U | U | U | U | E | | |
| CRESYLIC ACID | P | P | G | U | U | U | G | E | U | U |
| CRUDE OIL, SOUR | P | G | E | E | G | U | E | E | | |
| CRUDE OIL, SWEET | G | G | E | E | G | | E | E | | |
| CUPRIC NITRATE | | | E | | | | | E | | |

E-EXCELLENT

G-GOOD

P-POOR

U-UNSATISFACTORY



| FLUID | BRASS | CARBON STEEL | 216 S.S. | BUNA N (NITRILE) | NEO-PRENE | EPR | FLUORO-CARBON | PTFE | ACETAL | NYLON |
|---------------------------|-------|--------------|----------|------------------|-----------|-----|---------------|------|--------|-------|
| CUTTING OILS, | E | G | E | E | G | | E | E | E | |
| WATER EMULSIONS | | | | | | | | | | |
| CYANIDE PLATING SOLUTION | U | | G | G | G | G | G | E | | |
| CYCLOHEXANE | E | E | E | P | U | U | E | E | E | |
| CYCLOHEXANONE | G | | E | U | U | | | E | | |
| DECANE | | | | E | U | U | E | | | |
| DENATURED ALCOHOL | | | | E | E | E | E | | | |
| DETERGENTS, SYNTHETIC | G | U | G | G | G | G | E | E | | |
| DEXTRIN | G | | G | G | G | G | G | E | | |
| DIACETONE ALCOHOL | E | E | E | U | P | | | E | | |
| DICHLOROETHANE | | | P | U | U | U | | E | | |
| DICHLOROETHYL ETHER | G | | G | U | U | U | U | E | | |
| DIESEL OIL FUELS | E | E | E | E | P | U | E | E | | |
| DIETHYL BENZENE | | | G | U | U | U | | E | | |
| DIETHYL SULFATE | G | | G | P | P | P | G | E | | |
| DIETHYLAMINE | G | E | E | G | P | P | U | E | | |
| DIETHYLENE GLYCOL | G | E | E | E | E | E | G | E | | |
| DIMETHYL FORMAMIDE | G | | E | G | U | U | U | E | | |
| DIMETHYL PHTHALATE | | | U | G | G | | U | E | | |
| DIOCTYL PHTHALATE | E | | E | P | U | | P | E | | |
| DIOXANE | G | | G | U | U | P | U | E | | |
| DIPENTANE | E | | E | G | U | U | G | E | | |
| DISODIUM PHOSPHATE | | | G | G | G | | G | E | | |
| DOW CHEMICAL HD50-4 | | | | | G | E | U | | | |
| DOW CORNING 200, 510, 550 | | | | G | E | E | E | | | |
| DOWTHERM | E | G | E | U | U | U | E | E | E | |
| DRILLING MUD | G | G | E | E | P | E | E | E | E | |
| DRY CLEANING FLUIDS | P | G | E | U | U | | G | E | E | |
| DRYING OIL | P | P | G | E | G | | | E | E | |
| ENAMEL | E | | E | G | G | U | | E | | |
| EPSOM SALTS | G | P | G | E | E | | E | E | E | |
| ETHANE | G | P | G | E | G | U | E | E | E | |
| ETHANOL | E | U | U | U | E | E | U | | | |
| ETHANOLAMINE | U | G | E | G | P | | U | E | | |
| ETHERS | G | E | E | U | U | P | P | E | P | |
| ETHYL ACETATE | P | G | G | U | U | P | U | E | E | E |
| ETHYL ACRYLATE | G | P | E | U | U | P | U | E | | |
| ETHYL ALCOHOL | G | G | G | E | E | | E | E | | |
| ETHYL BENZENE | | | G | P | U | U | | E | E | |
| ETHYL BROMIDE | E | | G | G | G | G | G | E | | |
| ETHYL CHLORIDE, DRY | G | G | E | P | P | P | G | G | E | E |
| ETHYL CHLORIDE, WET | P | U | G | P | P | G | G | E | | |
| ETHYL ETHER | G | | E | U | U | U | U | E | | |
| ETHYL HEXANOL | | | | E | E | E | E | | | |
| ETHYL SILICATE | G | | G | G | P | G | G | E | | |
| ETHYL SULFATE | | | G | G | G | P | E | E | E | |
| ETHYLENE CHLORIDE | | | E | U | E | | U | E | | |
| ETHYLENE DICHLORIDE | U | U | G | U | U | U | U | E | | |
| ETHYLENE GLYCOL | G | G | G | E | G | E | E | E | | |
| ETHYLENE OXIDE | P | G | G | U | U | U | U | E | | |
| FATTY ACIDS | P | U | E | G | G | U | E | E | E | U |
| FERRIC CHLORIDE | U | U | U | E | U | | E | E | | U |
| FERRIC HYDROXIDE | | | E | G | | | | E | | |
| FERRIC NITRATE | U | U | P | E | E | E | E | E | E | U |
| FERRIC SULFATE | U | U | G | E | E | E | E | E | E | U |

E-EXCELLENT

G-GOOD

P-POOR

U-UNSATISFACTORY



| FLUID | BRASS | CARBON STEEL | 216 S.S. | BUNA N (NITRILE) | NEO-PRENE | EPR | FLUORO-CARBON | PTFE | ACETAL | NYLON |
|-------------------------------|-------|--------------|----------|------------------|-----------|-----|---------------|------|--------|-------|
| FERROUS AMMONIUM CITRATE | | | G | | | | | E | | |
| FERROUS CHLORIDE | G | U | U | E | E | E | E | E | E | U |
| FERROUS SULFATE | G | U | G | E | E | E | E | E | E | U |
| FERROUS SULFATE, SATURATED | P | P | E | P | P | G | G | E | | |
| FERTILIZER SOLUTIONS | P | G | G | G | G | | | E | G | |
| FISH OILS | G | G | E | E | G | U | E | E | G | |
| FLUE GASES | G | | E | P | P | U | P | E | P | |
| FLUOBORIC ACID | | | G | E | G | | | E | | U |
| FLUOROSILICIC ACID | G | U | G | P | P | P | P | E | | U |
| FLUORINE, DRY | U | | U | U | | | | | E | |
| FOOD FLUIDS & PASTES | G | P | E | G | E | | | E | | |
| FORMALDEHYDE, COLD | E | E | E | G | P | G | U | E | E | U |
| FORMALDEHYDE, HOT | G | U | P | G | G | | | E | E | U |
| FORMIC ACID, COLD | G | U | G | U | G | | G | E | U | E |
| FORMIC ACID, HOT | G | U | G | U | E | | E | E | U | |
| FRUIT JUICES | G | U | E | E | E | E | E | E | E | |
| FUEL OIL | G | G | E | E | P | U | E | E | E | |
| FUMARIC ACID | | | | G | G | | | E | | |
| FURFURAL | E | E | E | U | P | P | U | E | E | E |
| GALIC ACID 5% | P | U | G | G | G | P | E | E | E | |
| GAS, NATURAL | G | G | E | E | E | U | E | E | E | |
| GAS, ODORIZERS | E | G | G | G | G | | E | E | E | |
| GAS MFG. | G | G | G | E | | | E | E | E | |
| GASOLINE, AVIATION | E | E | E | P | U | | E | E | E | |
| GASOLINE, LEADED | E | E | E | P | U | | E | E | E | |
| GASOLINE, MOTOR | E | E | E | P | U | U | E | E | E | |
| GASOLINE, REFINED | G | G | E | P | P | U | E | E | | |
| GASOLINE, SOUR | G | G | E | P | U | U | E | E | E | |
| GASOLINE, UNLEADED | E | E | E | P | U | | E | E | E | E |
| GELATIN | E | U | E | E | E | E | E | E | E | |
| GLUCOSE | E | G | E | E | E | E | E | E | E | |
| GLUG | E | G | E | E | G | E | E | | | |
| GLYCERINE | G | P | E | P | U | E | G | E | P | E |
| GLYCOL | G | P | G | G | E | E | E | E | P | |
| GLYCOL AMINE | U | | G | E | | U | U | | | |
| GRAPHITE | G | | G | G | G | G | G | E | | |
| GREASE | P | E | E | E | G | U | E | E | | |
| GULF-FR FLUID, EMULSION | | | | E | G | U | E | | | |
| GULF-FR FLUID G | | | | E | E | E | E | | | |
| GULF-FR FLUID P | | | | U | U | G | G | | | |
| HELIUM GAS | G | E | E | G | G | G | G | E | | |
| HEPTANE | E | G | E | E | G | U | E | E | E | |
| HEXANE | G | G | E | E | P | U | E | E | E | E |
| HEXANOL, TERTIARY | E | E | E | E | P | U | G | E | | |
| HEXYL ALCOHOL | E | P | E | U | P | | E | E | | |
| HYDRAULIC OIL, PETROLEUM BASE | G | E | E | E | G | U | E | E | E | |
| HYDRAZINE | U | U | G | P | P | G | U | E | | |
| HYDRIGEN SULFIDE, DRY | P | G | E | P | E | E | E | E | | |
| HYDROCHLORIC ACID, AIR FREE | U | U | U | G | P | | E | E | | U |
| HYDROCYANIC ACID | U | U | E | G | G | G | E | E | U | |
| HYDROFLUORIC ACID | U | U | U | | G | | | | | U |
| HYDROFLUOSILICIC ACID | E | U | P | G | G | G | E | E | | U |
| HYDROGEN GAS, COLD | G | G | E | G | G | G | E | E | | |
| HYDROGEN GAS, HOT | G | G | G | G | G | | E | | | |
| HYDROGEN PEROXIDE, | U | U | G | U | U | G | G | E | | U |

E-EXCELLENT

G-GOOD

P-POOR

U-UNSATISFACTORY



| FLUID | BRASS | CARBON STEEL | 216 S.S. | BUNA N (NITRILE) | NEO-PRENE | EPR | FLUORO-CARBON | PTFE | ACETAL | NYLON |
|---------------------------|-------|--------------|----------|------------------|-----------|-----|---------------|------|--------|-------|
| CONCENTRATED | | | | | | | | | | |
| HYDROGEN PEROXIDE, DILUTE | P | U | G | E | G | G | E | E | G | U |
| HYDROGEN SULFIDE, WET | U | P | G | P | G | G | E | E | E | |
| HYDROLUBE | | | | E | G | E | E | | | |
| HYPO (SODIUM THIOSULFATE) | P | U | G | E | E | E | E | E | E | |
| HYPOCHLORITES, SODIUM | U | U | P | P | | | E | E | | |
| ILLUMINATING GAS | E | E | E | P | P | U | E | E | | |
| INK, NEWSPRINT | P | U | E | E | G | G | E | E | E | |
| IODINE, WET | U | U | U | G | | | E | E | | |
| IODOFORM | P | G | E | | | | E | E | E | |
| ISOPROPYL ACETATE | | | G | U | U | U | | E | | |
| ISOPROPYL ALCOHOL | G | G | G | P | G | | E | E | | |
| ISOPROPYL ETHER | E | E | E | P | P | U | U | E | | |
| ISO-BUTANE | | | G | G | U | U | | E | | |
| ISO-OCTANE | E | E | E | E | P | U | E | E | E | |
| J P-4 FUEL | E | E | E | E | P | | E | E | E | |
| J P-5 FUEL | E | E | E | G | P | | E | E | E | |
| J P-6 FUEL | E | E | E | E | P | | E | E | E | |
| KEROSENE | E | G | E | E | P | U | E | E | E | |
| KETCHUP | U | U | E | E | E | | E | E | E | |
| KETONES | E | E | E | U | U | U | U | E | E | |
| LACTIC ACID, CONC. COLD | U | U | E | G | E | G | E | E | U | U |
| LACTIC ACID, CONC. HOT | U | U | G | P | P | G | G | E | U | U |
| LACTIC ACID, DILUTE COLD | U | U | E | G | E | G | E | E | U | U |
| LACTIC ACID, DILUTE HOT | U | U | E | P | U | | U | E | U | U |
| LACTOSE | G | | G | G | P | G | G | E | | |
| LAQUER | E | P | E | U | U | U | U | E | E | E |
| LARD | G | E | E | G | P | P | | E | | |
| LARD OIL | G | P | G | E | G | G | E | E | E | |
| LEAD ACETATE | P | U | G | E | G | G | G | E | E | E |
| LEAD SULFATE | P | | G | G | G | G | G | E | | |
| LECITHIN | P | | G | U | U | U | G | E | | |
| LINOLEIC ACID | G | G | E | G | G | U | G | E | E | |
| LINSEED OIL | G | E | E | E | P | U | E | E | E | |
| LITHIUM CHLORIDE | G | | G | G | G | G | G | E | | |
| LPG | E | G | G | E | G | U | E | E | E | |
| LUBRICATING OIL | G | E | E | E | G | U | E | E | E | |
| LUDOX | U | | G | G | G | G | G | E | | |
| MAGNESIUM BISULFATE | G | G | E | G | G | G | G | E | | |
| MAGNESIUM BISULFIDE | U | | G | G | G | G | G | E | | |
| MAGNESIUM CARBONATE | G | | E | G | G | G | G | E | | |
| MAGNESIUM CHLORIDE | G | P | G | E | E | E | E | E | E | E |
| MAGNESIUM HYDROXIDE | G | G | E | E | E | E | E | E | E | |
| MAGNESIUM HYDROXIDE HOT | U | G | E | G | G | | E | E | E | |
| MAGNESIUM NITRATE | | | E | G | E | | G | E | | E |
| MAGNESIUM SALTS | | | | E | E | E | E | | | |
| MAGNESIUM SULFATE | G | G | E | E | E | E | E | E | E | E |
| MALEIC ACID | G | G | G | G | G | U | E | E | E | |
| MALEIC ANHYDRIDE | G | | G | U | U | U | G | E | | |
| MALIC ACID | G | U | G | E | G | | E | E | E | |
| MALT BEVERAGES | | | E | E | E | G | E | E | | |
| MANGANESE CARBONATE | | | G | G | | | | E | | |
| MANGANESE SULFATE | G | | E | G | G | G | G | E | | |
| MAYONNAISE | U | U | E | E | E | | E | E | E | |
| MEAT JUICES | U | | E | G | G | | | E | | |

E-EXCELLENT

G-GOOD

P-POOR

U-UNSATISFACTORY



A
B
C
D
E
F
G
H
I
J
K
L
M
N
O

| FLUID | BRASS | CARBON STEEL | 216 S.S. | BUNA N (NITRILE) | NEO-PRENE | EPR | FLUORO-CARBON | PTFE | ACETAL | NYLON |
|-------------------------|-------|--------------|----------|------------------|-----------|-----|---------------|------|--------|-------|
| MELAMINE RESINS | | | P | G | G | | | E | | |
| MERCURIC CHLORIDE | U | U | G | E | G | E | E | E | | |
| MERCURIC CYANIDE | U | U | E | E | G | E | E | E | | |
| MERCUROUS NITRATE | U | | E | | | | G | E | | |
| MERCURY | U | E | E | E | E | E | E | E | E | |
| METHANE | E | G | E | E | G | | E | E | E | |
| METHANOL | E | E | | E | E | E | U | | | |
| METHANOL | G | | E | G | G | U | G | E | | |
| METHYL ACETATE | E | G | E | U | U | G | U | E | | |
| METHYL ACETONE | E | E | E | U | U | E | U | E | | |
| METHYL ALCOHOL | G | G | G | E | G | | P | E | | E |
| METHYL BROMIDE 100% | P | G | G | G | U | U | G | E | | |
| METHYL CELLOSOLVE | E | G | E | P | U | G | U | E | | |
| METHYL CELLULOSE | | | E | U | U | | | E | | |
| METHYL CHLORIDE | G | G | E | U | U | U | G | E | E | |
| METHYL ETHER | | | | E | U | U | E | | | |
| METHYL ETHYL KETONE | E | E | E | U | U | G | U | E | E | E |
| METHYL FORMATE | E | P | G | U | G | G | U | E | | |
| METHYL ISOBUTYLE KETONE | | | E | U | U | | | E | | |
| METHYLAMINE | U | G | E | U | U | G | U | E | | |
| METHYLENE CHLORIDE | E | G | E | U | U | U | P | E | | U |
| MILK & MILK PRODUCTS | G | U | E | E | E | E | E | E | E | |
| MIL-F-81912, JP-9 | E | E | E | U | U | U | E | | | |
| MIL-H-5606 | E | E | E | E | G | U | E | | | |
| MIL-H-6083 | E | E | E | E | E | U | E | | | |
| MIL-H-7083 | E | E | E | E | G | E | G | | | |
| MIL-H-8446 | G | E | E | G | E | U | E | | | |
| MIL-L-2104 & 2104B | E | E | E | E | G | U | E | | | |
| MIL-L-7808 | U | G | E | G | U | U | E | | | |
| MINE WATERS, ACID | P | U | P | E | | | E | E | | |
| MINERAL OILS | G | G | E | E | G | U | E | E | E | |
| MINERAL SPIRITS | G | G | G | E | P | | E | E | E | |
| MIXED ACIDS, COLD | U | P | G | U | U | U | G | E | U | |
| MLO-7277 & MLO-7557 | G | E | E | U | U | U | E | | | |
| MOBILE HF | E | E | E | E | G | U | E | | | |
| MOLASSES, CRUDE | E | E | E | E | E | | E | E | E | |
| MOLASSES, EDIBLE | E | P | E | E | E | | E | E | E | |
| MOLYBDIC ACID | | | E | | | | | E | | |
| MONOCHLORO BENZENE DRY | | | G | U | U | | | E | | |
| MONOMETHYL HYDRAZINE | | | | G | G | E | | | | |
| MORPHOLINE | G | | E | U | U | G | U | E | | |
| MURIATIC ACID | U | U | U | G | | | E | E | | |
| MUSTARD | E | G | E | E | E | | E | E | E | |
| NAPHTHENIC ACID | G | E | G | G | U | U | E | | | |
| NAPHTHA | G | G | G | G | P | U | E | E | E | |
| NAPHTHALENE | G | G | G | U | U | U | E | E | E | |
| NATURAL GAS, SOUR | G | G | E | E | E | U | E | E | | |
| NEATSFOOT OIL | | | | E | U | G | E | | | |
| NICKEL ACETATE | U | G | E | G | G | E | U | | | |
| NICKEL AMMONIUM SULFATE | U | U | E | E | G | G | U | E | | |
| NICKEL CHLORIDE | U | U | G | E | E | G | E | E | E | E |
| NICKEL NITRATE | U | U | G | E | E | E | E | E | E | |
| NICKEL SALTS | | | | E | G | E | E | | | |
| NICKEL SULFATE | U | U | G | E | E | G | E | E | E | E |
| NITRIC ACID 100% | U | U | E | U | U | U | G | E | U | U |

E-EXCELLENT

G-GOOD

P-POOR

U-UNSATISFACTORY



| FLUID | BRASS | CARBON STEEL | 216 S.S. | BUNA N (NITRILE) | NEO-PRENE | EPR | FLUORO-CARBON | PTFE | ACETAL | NYLON |
|------------------------------|-------|--------------|----------|------------------|-----------|-----|---------------|------|--------|-------|
| NITRIC ACID 10% | U | U | E | P | G | | E | E | U | U |
| NITRIC ACID 30% | U | U | E | P | P | G | E | E | U | U |
| NITRIC ACID 80% | U | U | P | U | U | U | G | E | U | U |
| NITRIC ACID ANHYDROUS | U | U | E | U | U | U | E | E | | |
| NITROBENZENE | U | G | E | U | U | P | P | E | | E |
| NITROGEN | E | E | E | E | E | G | E | E | E | |
| NITROUS ACID 10% | U | U | G | P | E | | E | E | | |
| NITROUS GASES | U | G | E | | | | | E | | |
| NITROUS OXIDE | G | G | G | G | G | | E | E | | |
| NOCOTINIC ACID | E | G | E | U | U | U | G | E | | |
| OCTYL ALCOHOL | E | E | E | G | G | U | E | | | |
| OILS, ANIMAL | E | E | E | E | G | G | G | E | | |
| OILS, PETROLEUM REFINED | G | E | E | E | G | U | E | E | E | |
| OILS, PETROLEUM SOUR | P | G | E | G | G | U | E | E | | |
| OILS, WATER MIXTURE | E | G | E | E | G | | E | E | E | |
| OILS & FATS | | | E | G | | U | | E | | |
| OLAIC ACID | | | G | U | U | | P | E | | |
| OLEIC ACID | G | P | G | G | P | U | E | E | E | |
| OLEUM | P | G | G | U | U | U | P | E | U | |
| OLEUM SPIRITS | U | | G | P | U | U | E | E | | |
| OLIVE OIL | P | G | E | E | G | G | E | E | E | |
| ORTHO-DICHLOROBENZENE | G | G | G | U | U | U | E | | | |
| OTHER KETONES | E | E | E | U | U | U | U | E | | |
| OXALIC ACID | G | U | G | P | G | G | E | E | P | U |
| OXYGEN | E | G | E | G | G | E | E | E | U | |
| OZONE, DRY | E | E | E | U | U | E | G | E | | |
| OZONE, WET | G | P | E | U | U | G | G | E | | |
| PAINTS & SOLVENTS | E | E | E | U | U | U | G | E | | |
| PALM OIL | G | P | G | G | G | U | E | E | E | |
| PALMITIC ACID | G | P | G | G | G | G | E | E | E | |
| PAPER PULP | G | | E | G | G | G | G | E | | |
| PARAFFIN | E | G | E | E | P | U | E | E | E | |
| PARAFORMALDEHYDE | G | G | G | G | G | U | | E | E | |
| PARALDEHYDE | | | G | G | G | U | | E | | |
| PARA-DICHLOROBENZENE | G | E | E | U | U | U | E | | | |
| PARKER O LUBE | E | E | E | E | E | U | E | | | |
| PEANUT OIL | G | E | E | E | U | U | E | | | |
| PENTANE | E | G | E | E | G | U | E | E | E | |
| PERCHLORETHYLENE, DRY | P | G | E | U | U | U | E | E | | |
| PERCHLORIC ACID-2N | U | U | G | U | G | G | E | | | |
| PETROLATUM (PETROLEUM JELLY) | G | P | G | E | G | | E | E | E | |
| PHENOL | G | U | E | U | U | U | G | E | U | E |
| PHOSPHATE ESTER | U | E | E | U | | E | | E | | |
| PHOSPHORIC ACID 10% | U | U | U | G | E | G | E | E | U | U |
| PHOSPHORIC ACID 50% COLD | U | U | G | G | G | G | E | E | U | U |
| PHOSPHORIC ACID 50% HOT | U | U | U | G | G | G | E | E | U | U |
| PHOSPHORIC ACID 85% COLD | G | G | E | P | P | | G | E | U | U |
| PHOSPHORIC ACID 85% HOT | P | P | G | P | P | | | E | U | U |
| PHOSPHORIC ANHYDRIDE | | | E | U | U | | G | E | G | |
| PHOSPHOROUS TRICHLORIDE | U | G | E | U | U | G | G | E | | |
| PHTHALIC ACID | G | P | G | P | P | | E | E | E | |
| PHTHALIC ANHYDRIDE | G | P | G | P | P | | E | E | E | |
| PICRIC ACID | P | U | G | P | E | G | G | E | | |
| PINE OIL | G | G | E | E | U | U | E | E | E | |
| PINEAPPLE JUICE | P | P | E | E | E | | E | E | E | |

E-EXCELLENT

G-GOOD

P-POOR

U-UNSATISFACTORY



| FLUID | BRASS | CARBON STEEL | 216 S.S. | BUNA N (NITRILE) | NEO-PRENE | EPR | FLUORO-CARBON | PTFE | ACETAL | NYLON |
|---------------------------------|-------|--------------|----------|------------------|-----------|-----|---------------|------|--------|-------|
| PITCH | | | E | P | P | U | | E | | |
| PLATING SOLUTIONS, CHROME | E | U | E | | U | E | E | | | |
| PLATING SOLUTIONS, OTHER | | E | E | E | U | E | E | | | |
| PNEUMATIC SERVICE | E | E | E | E | E | E | E | E | | |
| POLYSULFIDE LIQUOR | U | | G | G | G | G | G | E | | |
| POLYVINYL ACETATE | G | | G | | P | G | | E | | |
| POLYVINYL CHLORIDE | G | | G | | P | G | | E | | |
| POTASSIUM ACETATE | G | E | G | G | G | E | U | | | |
| POTASSIUM BICARBONATE | | | E | G | | | | E | | E |
| POTASSIUM BICHROMATE | | | E | G | G | | G | E | G | |
| POTASSIUM BISULFATE | | | E | G | G | | E | E | | |
| POTASSIUM BISULFITE | P | U | G | E | E | G | E | E | E | |
| POTASSIUM BROMIDE | P | U | E | E | E | G | E | E | E | P |
| POTASSIUM CARBONATE | G | G | G | E | E | G | E | E | E | E |
| POTASSIUM CHLORATE | G | G | G | E | E | G | E | E | E | P |
| POTASSIUM CHLORIDE | P | P | G | E | E | E | E | E | E | P |
| POTASSIUM CHROMATE | G | | G | G | E | G | G | E | | |
| POTASSIUM CYANIDE | U | G | G | E | E | E | E | E | E | E |
| POTASSIUM DICHROMATE | U | P | G | E | E | G | E | E | E | U |
| POTASSIUM DIPHOSPHATE | G | E | E | E | | | E | E | | |
| POTASSIUM FERRICYANIDE | U | P | E | E | E | G | E | E | E | |
| POTASSIUM FERROCYANIDE | G | P | G | E | E | | E | E | E | |
| POTASSIUM HYDROXIDEDILUTE COLD | U | E | G | E | G | | U | E | | E |
| POTASSIUM HYDROXIDE DILUTE HOT | U | G | G | G | G | | | E | | |
| POTASSIUM HYDROXIDE TO 70% COLD | | | | | | | | | | |
| POTASSIUM HYDROXIDE TO 70% HOT | U | E | G | P | G | E | | E | | |
| POTASSIUM HYDROXIDE TO 70% HOT | U | E | G | P | G | E | | E | | |
| POTASSIUM IODIDE | U | P | G | E | E | G | E | E | E | |
| POTASSIUM NITRATE | G | G | G | E | E | G | E | E | E | P |
| POTASSIUM OXALATE | | | E | | | | | E | | |
| POTASSIUM PERMANGANATE | G | G | G | E | E | G | E | E | E | U |
| POTASSIUM PHOSOHATE | P | | G | E | E | E | E | E | | |
| POTASSIUM PHOSPHATE DI-BASIC | G | E | E | E | E | G | E | E | E | |
| POTASSIUM PHOSPHATE TRI-BASIC | | E | G | G | G | G | | E | | |
| POTASSIUM SALTS | | | | E | E | E | E | | | |
| POTASSIUM SULFATE | G | G | E | E | E | E | E | E | E | P |
| POTASSIUM SULFIDE | G | G | E | E | G | G | G | E | | |
| POTASSIUM SULFITE | G | G | E | G | G | E | G | E | | |
| PRODUCER GAS | G | G | G | E | G | U | E | E | E | |
| PROPANE GAS | E | G | G | E | G | U | E | E | E | |
| PROPYL ACETATE | U | E | E | U | U | G | U | | | |
| PROPYL ALCOHOL | E | G | G | E | E | | E | E | | |
| PROPYL BROMIDE | G | | G | G | G | G | G | E | | |
| PROPYLENE | E | E | E | U | U | U | E | | | |
| PROPYLENE GLYCOL | G | G | G | E | E | G | E | E | P | |
| PYDRAUL | E | P | E | U | U | | G | E | | |
| PYRIDINE | | | G | U | U | | U | E | | |
| PYROGARD 42, 43, 53, 55 | | | | U | U | E | E | | | |
| PYROGARD D | | | | E | G | E | E | | | |
| PYROLGALIC ACID | G | G | G | E | E | | E | E | E | |
| QUENCH OIL | G | G | E | E | G | | E | E | E | |
| QUININE, SULFATE, DRY | | | E | | | | | E | | |
| R P-1 FUEL | E | E | E | G | P | | E | E | E | |
| RESINS & ROSINS | E | P | E | P | P | | E | E | E | |
| RESORCINOL | | | G | | | | | E | | |

E-EXCELLENT

G-GOOD

P-POOR

U-UNSATISFACTORY



| FLUID | BRASS | CARBON STEEL | 216 S.S. | BUNA N (NITRILE) | NEO-PRENE | EPR | FLUORO-CARBON | PTFE | ACETAL | NYLON |
|------------------------------|-------|--------------|----------|------------------|-----------|-----|---------------|------|--------|-------|
| ROAD TAR | E | E | E | G | P | U | E | E | E | |
| ROOF PITCH | E | E | E | G | P | | E | E | E | |
| ROSIN EMULSION | G | P | E | U | P | | G | E | | |
| RUBBER LATEX EMULSIONS | E | G | E | | | | E | E | E | |
| RUBBER SOLVENTS | E | E | E | U | P | | U | E | P | |
| SALAD OIL | G | P | G | E | E | G | E | E | E | |
| SALICYLIC ACID | P | U | E | E | E | G | E | E | E | |
| SALT | G | P | G | E | E | | E | E | E | |
| SALT BRINE | G | | G | E | U | G | G | E | | |
| SAUERKRAUT ARINE | | | G | | | | | E | | |
| SEA WATER | P | U | G | E | E | E | E | E | E | |
| SEWAGE | P | P | G | E | P | G | G | E | | |
| SHELL IRUS 905 | | | | E | G | U | E | | | |
| SHELLAC | E | E | E | E | E | | | E | | |
| SILICONE FLUIDS | G | | G | G | G | | G | E | | |
| SILVER BROMIDE | | | | | | | | | | |
| SILVER CYANIDE | U | | E | G | G | | G | E | | |
| SILVER NITRATE | U | U | E | P | P | E | E | E | E | |
| SILVER PLATING SOL. | | | E | | G | | | E | | |
| SKYDROL 500 | E | G | E | U | U | | U | E | | |
| SKYDROL 7000, TYPE 2 | U | E | E | U | U | E | G | | | |
| SOAP SOLUTIONS | E | E | E | E | G | E | E | E | | |
| SODIUM ACETATE | G | P | G | G | G | G | E | E | E | E |
| SODIUM ALUMINATE | G | P | E | E | E | G | E | E | E | |
| SODIUM BENZOATE | | | G | | | | | E | | |
| SODIUM BICARBONATE | G | P | G | E | E | E | E | E | E | E |
| SODIUM BICHROMATE | | | G | U | | | | E | | |
| SODIUM BISULFATE 10% | G | U | E | E | E | G | E | E | E | P |
| SODIUM BISULFITE 10% | G | U | E | E | E | G | E | E | E | P |
| SODIUM BORATE | G | P | G | E | E | G | E | E | E | |
| SODIUM BROMIDE 10% | G | P | G | E | E | G | E | E | E | |
| SODIUM CARBONATE | G | G | E | E | E | G | E | E | E | E |
| SODIUM CHLORATE | G | P | G | E | E | G | E | E | E | P |
| SODIUM CHLORIDE | G | P | G | E | E | G | E | E | E | E |
| SODIUM CHROMATE | P | G | E | E | E | G | E | E | E | |
| SODIUM CITRATE | | | G | | | | | E | | |
| SODIUM CYANIDE | U | G | E | E | E | G | E | E | E | E |
| SODIUM FERRICYANIDE | | | E | | | | | E | | |
| SODIUM FLUORIDE | P | U | G | E | E | G | E | E | E | |
| SODIUM HYDROXIDE 20% COLD | E | E | E | E | E | G | G | E | | E |
| SODIUM HYDROXIDE 20% HOT | E | G | E | G | G | G | P | E | | |
| SODIUM HYDROXIDE 50% COLD | E | E | E | E | E | G | P | E | | E |
| SODIUM HYDROXIDE 50% HOT | E | G | E | G | G | | P | E | | |
| SODIUM HYDROXIDE 70% COLD | E | E | E | G | P | G | P | E | | |
| SODIUM HYDROXIDE 70% HOT | G | G | E | U | U | G | P | E | | |
| SODIUM HYPOCHLORITE (BLEACH) | U | U | U | | | | E | E | | U |
| SODIUM HYPOSULFITE | | | G | | | | | E | | |
| SODIUM LACTATE | | | E | | | | | E | | |
| SODIUM METAPHOSPHATE | P | G | G | E | E | G | | E | | |
| SODIUM METASILICATE COLD | G | P | E | G | E | | G | E | | |
| SODIUM METASILICATE HOT | G | U | E | | | | | E | | |
| SODIUM NITRATE | G | G | E | P | G | G | E | E | E | E |
| SODIUM NITRITE | | | G | P | U | E | G | E | G | |
| SODIUM PERBORATE | G | G | G | P | G | E | E | E | E | |
| SODIUM PEROXIDE | U | P | G | P | G | E | E | E | E | |

E-EXCELLENT

G-GOOD

P-POOR

U-UNSATISFACTORY



A
B
C
D
E
F
G
H
I
J
K
L
M
N
O

| FLUID | BRASS | CARBON STEEL | 216 S.S. | BUNA N (NITRILE) | NEO-PRENE | EPR | FLUORO-CARBON | PTFE | ACETAL | NYLON |
|----------------------------|-------|--------------|----------|------------------|-----------|-----|---------------|------|--------|-------|
| SODIUM PHOSPHATE | P | P | G | G | P | E | E | E | G | |
| SODIUM PHOSPHATE DI-BASIC | P | P | G | E | E | E | E | E | E | |
| SODIUM PHOSPHATE TRI-BASIC | P | P | G | G | G | E | E | E | E | |
| SODIUM POLYPHOSPHATE | | | G | G | G | E | | E | | |
| SODIUM SALICYLATE | | | E | | | | | E | | |
| SODIUM SALTS | | | | | | | | | | |
| SODIUM SILICATE | G | G | G | E | E | G | E | E | E | E |
| SODIUM SILICATE, HOT | P | P | G | | | G | | E | | |
| SODIUM SULFATE | G | G | E | E | E | E | E | E | | E |
| SODIUM SULFIDE | U | G | G | E | E | G | E | E | E | E |
| SODIUM SULFITE | P | | E | E | E | G | G | E | | |
| SODIUM TETRABORATE | | | E | E | E | G | | E | | |
| SODIUM THIOSULFATE | P | G | E | E | E | E | E | E | E | |
| SOYBEAN | G | P | E | E | G | G | E | E | E | |
| STANNIC CHLORIDE | P | U | U | E | E | | E | E | | |
| STARCH | G | P | G | E | E | P | E | E | E | |
| STEAM (212 F) | E | E | E | U | U | G | P | E | U | |
| STEARIC ACID | P | P | G | E | P | G | E | E | E | |
| STODDARD SOLVENT | G | E | E | E | G | U | E | | | |
| STYRENE | E | E | E | U | U | U | G | E | | |
| SUCROSE SOLUTIONS | E | E | E | E | G | E | E | | | |
| SUGAR, SYRUPS & JAM | G | | E | | G | | | E | | |
| SUGAR LIQUIDS | E | G | E | E | E | G | E | E | E | |
| SULFATE, BLACK LIQUOR | P | P | G | P | G | G | P | E | E | |
| SULFATE, GREEN LIQUOR | P | P | G | P | G | | P | E | E | |
| SULFATE, WHITE LIQUOR | P | P | G | P | G | | P | E | E | |
| SULFUR | U | P | G | U | P | G | G | E | E | |
| SULFUR, MOLTEN | U | P | G | U | P | G | G | E | | |
| SULFUR CHLORIDES | G | U | U | U | U | P | E | E | E | |
| SULFUR DIOXIDE, DRY | G | G | E | U | U | E | E | E | E | |
| SULFUR DIOXIDE, WET | U | | E | U | U | G | | E | | |
| SULFUR HEXAFLUORIDE | G | | E | | G | | | E | | |
| SULFUR TRIOXIDE | G | G | G | U | U | | G | E | | |
| SULFUR TRIOXIDE, DRY | G | G | G | U | U | G | E | E | | |
| SULFURIC ACID 0 TO 77% | P | U | P | G | G | | E | E | P | U |
| SULFURIC ACID 100% | P | P | E | U | U | P | G | E | U | U |
| SULFUROUS ACID | U | U | G | P | P | P | E | E | P | |
| SUNSAFE | U | E | E | E | G | U | E | | | |
| TALL OIL | G | G | G | G | G | U | E | E | | |
| TANNIC ACID | G | P | G | G | G | G | E | E | E | U |
| TANNING LIQUORS | | | G | G | U | | | E | | |
| TAR & TAR OILS | E | E | E | P | U | U | E | E | | |
| TARTARIC ACID | G | U | E | P | G | G | E | E | E | |
| TERPINEOL | | | | G | U | U | E | | | |
| TERTIARY BUTYL ALCOHOL | E | E | E | G | G | G | E | | | |
| TETRACHLOROETHANE | | G | E | U | U | U | E | | | |
| TETRACHLOROETHYLENE | U | G | U | U | U | E | | | | |
| TETRAETHYL LEAD | G | P | G | | | | | E | E | |
| TITANIUM TETRACHLORIDE | G | E | G | G | U | U | E | | | |
| TOLUOL (TOLUENE) | E | E | E | U | U | U | G | E | E | E |
| TOMATO JUICE | P | P | E | E | E | | E | E | E | |
| TRANSFORMER OIL | G | E | E | E | G | | E | E | E | |
| TRANSMISSION FLUID, TYPE A | E | E | E | E | G | U | E | E | E | |
| TRIBUTYL PHOSPHATE | E | E | E | U | U | G | U | E | | |
| TRICHLOROETHYLENE | G | G | G | U | U | U | G | E | E | U |

E-EXCELLENT

G-GOOD

P-POOR

U-UNSATISFACTORY



| FLUID | BRASS | CARBON STEEL | 216 S.S. | BUNA N (NITRILE) | NEO-PRENE | EPR | FLUORO-CARBON | PTFE | ACETAL | NYLON |
|----------------------|-------|--------------|----------|------------------|-----------|-----|---------------|------|--------|-------|
| TRICHLOROACETIC ACID | G | | U | P | U | | U | E | | |
| TRICHLOROETHANE | | G | E | U | U | U | E | | | |
| TRICRESYL PHOSPHATE | | E | G | U | U | E | G | | | |
| TRIETHANOLAMINE | | | G | P | G | G | | E | | |
| TRIETHYLAMINE | G | | G | G | G | | | E | | |
| TRISODIUM PHOSPHATE | | | G | E | E | G | G | E | | |
| TUNG OIL | G | G | E | E | G | U | E | E | E | |
| TURBINE OIL #15 | | G | E | G | U | U | E | | | |
| TURPENTINE | G | G | G | G | U | U | E | E | E | E |
| UREA | U | P | G | P | G | G | U | E | E | |
| URIC ACID | | | E | | | | | E | | |
| VARNISH | E | P | E | P | G | U | G | E | E | |
| VEGETABLE OILS | G | G | E | E | G | U | E | E | E | |
| VINEGAR | G | U | E | U | U | E | U | E | | E |
| VINYL ACETATE | G | | G | | G | E | | E | | |
| WATER, ACID MINE | U | U | G | G | E | E | U | E | | |
| WATER, DISTILLED | U | U | E | P | G | G | E | E | E | |
| WATER, FRESH | P | P | E | P | G | G | E | E | E | |
| WAXES | E | E | E | E | G | P | E | E | E | |
| WHISKEY & WINES | G | U | E | G | G | E | E | E | E | |
| XYLENE (XYLOL), DRY | E | G | E | U | U | U | G | E | E | E |
| ZINC BROMIDE | G | | G | G | G | G | G | E | | |
| ZINC CHLORIDE | U | U | U | G | G | | E | E | | U |
| ZINC HYDROSULFITE | P | E | E | E | E | E | E | E | E | |
| ZINC SULFATE | G | U | G | E | E | E | E | E | E | P |

E-EXCELLENT

G-GOOD

P-POOR

U-UNSATISFACTORY

- A
- B
- C
- D
- E
- F
- G
- H
- I
- J
- K
- L
- M
- N
- O



- A
- B
- C
- D
- E
- F
- G
- H
- I
- J
- K
- L
- M
- N
- 0

| | | | | | |
|------------------|-----|----------------|----------|-----------------|----------|
| 1F..... | H7 | 48F-X-MI..... | J24 | 62PCA | G13, G30 |
| 2GF | H7 | 48F-X-MIX..... | H9 | 62PCABH..... | G13, G30 |
| 3GF | H7 | 48IFHD..... | H15 | 62PLM | A50 |
| 4CB-SR..... | L9 | 50CT..... | L11 | 62PLMBH..... | A50 |
| 9-DC..... | L10 | 50GHSV..... | J26 | 62PLMSP..... | A52 |
| 14FL..... | H7 | 53GH | J26 | 62PLP | A7, A15 |
| 14FS | H7 | 54GH | J26 | 62PLPBH..... | A7 |
| 14FSV | H7 | 55GH | J26 | 62PLPSP..... | A15 |
| 14FSX | H7 | 56PSG | G29 | 62PLS | A58 |
| 16-CB | L9 | 56RBSG..... | F18 | 62PLSBH..... | A59 |
| 18-DC..... | L10 | 59CA..... | G13 | 62PTC..... | E13 |
| 20..... | I6 | 59HD | G38 | 62RB | F18 |
| 22..... | I6 | 59P..... | G29 | 62TF | F12 |
| 22BH | I6 | 60AB | F14 | 62VL | F20 |
| 22CA..... | I6 | 60C..... | G8 | 63NTA..... | F8 |
| 22CABH..... | I6 | 60NTA..... | F7 | 63PLM | A52 |
| 24B-Cabinet..... | L10 | 60P..... | G29 | 63PLP | A38 |
| 24-CB | L9 | 60PB..... | G29 | 63PT | G9, G14 |
| 24M..... | E10 | 60PT | G8 | 66AB..... | F14 |
| 24PLP | A35 | 60RB | F18 | 66BJB..... | A32 |
| 24PLPD..... | A36 | 60TF..... | F12 | 66C..... | G9 |
| 26..... | I6 | 60VL..... | F20 | 66CA..... | G14 |
| 27..... | I6 | 60VLV..... | F20 | 66HD | G36 |
| 28..... | I7 | 61AB..... | F14 | 66LF | A20, A21 |
| 30GH | C43 | 61C..... | G8 | 66NBH..... | F8 |
| 31GH | C43 | 61CA..... | G13 | 66NTA..... | F8 |
| 31HB..... | C43 | 61CL..... | G8 | 66P..... | G30 |
| 32PLCK..... | B29 | 61HD | G36 | 66PLM | A46 |
| 32PLP | A33 | 61NTA..... | F7 | 66PLMBH..... | A50 |
| 32PLPBH..... | A35 | 61P | G29 | 66PLP | A8 |
| 32PLPBHP | A41 | 61PB..... | G29 | 66PLPBH..... | A8 |
| 32PLPDJ | A32 | 61PN..... | G29 | 66PTC..... | E13 |
| 32PLPDJB..... | A31 | 61PSGN..... | G29 | 66RBSV..... | F18 |
| 32PLPDRC..... | A40 | 61RB..... | F18 | 66VL | F21 |
| 32PLPRC..... | A40 | 61RBSG..... | F18 | 67PLM | A51 |
| 32PLPSP..... | A39 | 61TF | F12 | 67PLP | A15 |
| 32PTC..... | E7 | 61VL | F20 | 67PLS | A60 |
| 37PLP | A39 | 62AB..... | F14 | 67RBSG..... | F18 |
| 37PTCSP..... | E8 | 62ABH..... | F14 | 68ALS | E23 |
| 40B-Cabinet..... | L11 | 62ANBH..... | F7 | 68BJB..... | A31 |
| 41FL..... | H8 | 62C..... | G8 | 68BJBD..... | A32 |
| 41FS | H8 | 62CA..... | G13 | 68BJBT..... | A32 |
| 41FX..... | H8 | 62CABH..... | G13 | 68C..... | G9 |
| 41IF | H15 | 62HD | G36 | 68CA..... | G14 |
| 42F | H8 | 62HDBH..... | G36 | 68HB | I10 |
| 42IFHD..... | H15 | 62NBH..... | F7 | 68HB-X-MI..... | J24 |
| 43F | H8 | 62NFBH..... | F7 | 68HB-X-MIX..... | I10 |
| 46F | H9 | 62NTA..... | F7 | 68HD | G37 |
| 46IFHD..... | H15 | 62P..... | G29, G30 | 68LF | A22 |
| 48F..... | H9 | 62PBH..... | G30 | 68LFR | A21 |

| | | | | | |
|------------------|----------|------------------|----------|--------------------|----------|
| 68NTA-X-MI..... | J24 | 0110 | G25, G27 | 164PLM..... | A51 |
| 68NTA-X-MIX..... | F8 | 0111 | G25 | 164PLP | A10 |
| 68P..... | G31 | 0114 | G20 | 164PLS | A59 |
| 68PLCK..... | B30 | 0116 | G23 | 164PMT | E14 |
| 68PLCKI..... | B30 | 0117 | J15 | 164VL..... | F21 |
| 68PLM | A46 | 0118..... | G22 | 165C..... | G10 |
| 68PLMSP | A47 | 0119 | G22, G23 | 165CA..... | G15 |
| 68PLP | A9, A10 | 0121 | J15 | 165HD..... | G36 |
| 68PLPR..... | A10 | 122HBL..... | I10 | 165PLM..... | A51 |
| 68PLPSP..... | A29 | 122PLMSP | A52 | 165PLMBH | A51 |
| 68PLS..... | A55 | 0123 | I13 | 165PLP | A11 |
| 68PLSSP..... | A56 | 0124 | G25 | 165PLS | A59 |
| 68PTC..... | E14 | 0125 | G27 | 165PMT | E14 |
| 68RB | F18 | 125HB..... | I10 | 165PMTBH..... | E18 |
| 68RBSG..... | F18 | 125HBL..... | I10 | 166FSV | H12 |
| 68TF | F12 | 125HBLSV | I11 | 0168 | G27, J16 |
| 68VL | F21 | 126HBL..... | I11 | 0169 | J16 |
| 69GH | J26 | 0127..... | G27 | 169C..... | G10 |
| 70GH | J26 | 127HB..... | I11 | 169CA..... | G15 |
| 71GH | J26 | 128HBLSV | I11 | 169HB-X-MI | J24 |
| 75GH | J26 | 129HB..... | I11 | 169HB-X-MIX..... | I12 |
| 76RB | F18 | 0136..... | I14 | 169HD..... | G37 |
| 78GH | J26 | 0139..... | A16 | 169LP | G33 |
| 79GH | J26 | 139HB..... | I12 | 169P | G33 |
| 80GH | J26 | 139PLP | A15 | 169PLM..... | A47, A48 |
| 81GH | J26 | 0142..... | G24 | 169PLMBJ..... | A52 |
| 82GH | J26 | 0143..... | J14 | 169PLMX..... | A48 |
| 83GH | J26 | 0144..... | J14 | 169PLP | A12 |
| 88AC..... | H19 | 144F | H10 | 169PLS | A57 |
| 88GH | J26 | 0145..... | J14 | 169PLSX | A58 |
| 90GH | J26 | 145F | H10 | 169PMT | E14 |
| 94GH | J26 | 146HBLFSV | I12 | 169PMTBH..... | E18 |
| 95GH | J27 | 149F | H10 | 169PMTL..... | E15 |
| 96GH | J27 | 149F-X-MI | J24 | 169PMTNS..... | E15 |
| 97HC | I13 | 149F-X-MIX | H11 | 169PMTNS-X-M | E4, E15 |
| 97P..... | G31 | 150F | H11 | 169VL..... | F21 |
| 98GH | J27 | 151F..... | H11 | 170C..... | G11 |
| 98GHSV | J27 | 0152 | J14 | 170CA..... | G16 |
| 99GH | J27 | 0155 | J16 | 170HD..... | G37 |
| 99GHSV | J27 | 155F | H11 | 170P | G34 |
| 0101..... | G18, G19 | 0158 | J15 | 170PMT | E15 |
| 101GHSV..... | J27 | 159F | H12 | 170PMTNS..... | E15 |
| 0102 | G24 | 159F-X-MI | J24 | 170VL..... | F22 |
| 0103 | G22 | 159F-X-MIX | H12 | 171C | G11 |
| 0104 | G24 | 0163 | J16 | 171CA | G16 |
| 0105 | G18 | 0164 | J14 | 171HB | I12 |
| 0106 | G23 | 164C..... | G10 | 171HD..... | G37 |
| 0107..... | G24 | 164CA..... | G15 | 171P | G34 |
| 0108 | G21 | 164HD..... | G36 | 171PLM..... | A48, A49 |
| 0109 | G20, G21 | 164P | G33 | 171PLP..... | A13 |

| |
|---|
| A |
| B |
| C |
| D |
| E |
| F |
| G |
| H |
| I |
| J |
| K |
| L |
| M |
| N |
| 0 |

| | | | | | |
|-----------------|----------|---------------|----------|----------------|----------|
| 171PMT..... | E16 | 226-BPD..... | M6 | 329HB..... | C42 |
| 171PMTNS..... | E16 | 228..... | I8 | 347PLP..... | A36 |
| 171VL..... | F22 | 229..... | I8 | 362HB..... | C42 |
| 172C..... | G11 | 230..... | I8 | 362PLP..... | A34 |
| 172CA..... | G16 | 231..... | I8 | 362PLPD..... | A35 |
| 172HD..... | G37 | 232..... | I8 | 362PLPDSP..... | A38 |
| 172P..... | G34 | 237..... | I8 | 362PLPSP..... | A38 |
| 172PLM..... | A49, A50 | 238..... | I8 | 362PTC..... | E7 |
| 172PLP..... | A14 | 244F..... | H10 | 362PW..... | A15 |
| 172PMT..... | E16 | 244IFHD..... | H16 | 364HB..... | C40 |
| 172PMTNS..... | E16 | 245IFHD..... | H16 | 364PLP..... | A34 |
| 172VL..... | F22 | 249F..... | H10 | 364PTC..... | E7 |
| 176C..... | G11 | 249IF..... | H16 | 365HB..... | C40 |
| 176CA..... | G16 | 250IFHD..... | H16 | 365PLP..... | A33, A34 |
| 177C..... | G11 | 251IFHD..... | H16 | 365PLPBH..... | A35 |
| 177CA..... | G16 | 252IFHD..... | H16 | 365PTC..... | E7 |
| 177HD..... | G38 | 255IFHD..... | H16 | 368PLP..... | A29 |
| 177P..... | G34 | 255M..... | J12 | 368PLPD..... | A30 |
| 179C..... | G11 | 256F..... | H13 | 369PLP..... | A23 |
| 179CA..... | G16 | 259F..... | H12 | 369PLPBJ..... | A31 |
| 179HB..... | I12 | 259IFHD..... | H16 | 369PLPBJB..... | A31 |
| 179HB-X-MI..... | J24 | 264AB..... | F15 | 369PLPO..... | A43 |
| 179HD..... | G37 | 264C..... | G10 | 369PLPSP..... | A36 |
| 179PMT..... | E17 | 264CA..... | G15 | 369PLPSPX..... | A37 |
| 179PMTNS..... | E17 | 264NTA..... | F9 | 369PLPTJ..... | A32 |
| 179VL..... | F22 | 265AB..... | F15 | 369PLPTJB..... | A31 |
| 189PMTR..... | E17 | 265C..... | G10 | 369PLPX..... | A24 |
| 0191..... | I14 | 265CA..... | G15 | 369PTCSP..... | E8 |
| 0192..... | J20 | 265NTA..... | F9 | 370HB..... | C42 |
| 0199..... | G21 | 269C..... | G10 | 370PLP..... | A30 |
| 207ACBH..... | F16 | 269CA..... | G15 | 370PTCR..... | E8 |
| 207P..... | J8 | 269HB..... | I13 | 371PLP..... | A28 |
| 208P..... | J8 | 269TF..... | F12 | 371PLPSP..... | A37, A38 |
| 209P..... | J8 | 270AB..... | F15 | 371PTCSP..... | E9 |
| 210P..... | J9 | 270C..... | G11 | 372HB..... | C42 |
| 211P..... | J9 | 270CA..... | G16 | 372PLP..... | A27 |
| 212P..... | J9 | 270NTA..... | F9 | 372PLPSP..... | A37 |
| 213P..... | J9 | 279HB..... | I13 | 372PTCSP..... | E9 |
| 215PN..... | J9 | 309P..... | C40 | 376PLPBJ..... | A32 |
| 215PNL..... | J9 | 313GH..... | C43 | 377PLP..... | A27 |
| 216P..... | J10 | 316GH..... | C43 | 377PTC..... | E9 |
| 218P..... | J10 | 316P..... | C41 | 379PLP..... | A25 |
| 219P..... | J10 | 318P..... | C40 | 379PLPSP..... | A37 |
| 0220..... | G27, I7 | 322HB..... | C40 | 391P..... | G31 |
| 220P..... | J10 | 322PLPSP..... | A39, A40 | 391PSS..... | G31 |
| 222P..... | J10 | 325GH..... | C43 | 392P..... | G31 |
| 222P-X-MI..... | J24 | 325GHSV..... | C43 | 392PSS..... | G31 |
| 222P-X-MIX..... | J14 | 325HB..... | C41 | 393P..... | G31 |
| 224..... | I7 | 326HB..... | C41 | 393PD..... | G32 |
| 225..... | I7 | 328HB..... | C43 | 393PDSS..... | G32 |

| | | |
|---------------------|---------------------|----------------------|
| 393PSS.....G31 | 880AC.....H19 | 1795HB.....I13 |
| 394P.....G32 | 881AC.....H19 | 01802.....I15 |
| 394PD.....G32 | 0900.....J19 | 2200P.....J10 |
| 394PDSS.....G32 | 901GH.....J27 | 2200PDE.....J12 |
| 394PSS.....G32 | 0902.....J20 | 2201P.....J12 |
| 398P.....G32 | 0903.....J18 | 2202P.....J11 |
| 398PD.....G33 | 0904.....J19 | 2203P.....J11 |
| 398PDSS.....G33 | 0905.....J19 | 2205P.....J12 |
| 398PSS.....G32 | 0906.....J19 | 2214P.....J12 |
| 400-S-TIP.....L5 | 0907.....J19 | 2224P.....J11 |
| 410.....L5 | 0908.....J18 | 2225P.....J11 |
| 410-N.....L5 | 0909.....J18 | 2491FHD.....H16 |
| 410-S.....L5 | 0910.....J17 | 3000 71 11.....M5 |
| 410-SV.....L5 | 0911.....J17 | 3000 71 11 05.....M5 |
| 411FF.....H15 | 0912.....J17 | 3100.....D6 |
| 411FS.....H15 | 0913.....J17 | 3110.....A41 |
| 415-N.....L5 | 0914.....J17 | 3151.....A40 |
| 415-S.....L5 | 0915.....J17 | 3330.....A41 |
| 485F.....H9 | 0916.....J18 | 4202.....K60 |
| 0610.....L7 | 0917.....J18 | 4203.....K60 |
| 0611.....L8 | 0920.....J19 | 4890.....B32 |
| 0614.....L8 | 0921.....J17 | 4891.....B32 |
| 639C.....G11 | 0922.....J17 | 4892.....B32 |
| 639CA.....G16 | 0923.....J18 | 4895.....B32 |
| 639F.....H13 | 0924.....J18 | 06167.....I15 |
| 639PLM.....A52 | 0927.....J18 | 06172.....I15 |
| 639PLP.....A39, E19 | 0928.....J18 | 06244S.....I15 |
| 639PLS.....A60 | 0929.....J15 | 06254S.....I15 |
| 640F.....H13 | 0931.....I14 | 06256S.....I15 |
| 640QSF.....H19 | 945TH-BPD.....M6 | 06264S.....I15 |
| 640QSFCR.....H19 | 1163-60-BPD.....J27 | 06266S.....I15 |
| 0660.....B36 | 1163-61-BPD.....J27 | 6300.....D8 |
| 660FHD.....H13 | 01200.....I15 | 6302.....C11 |
| 0661.....B36 | 1200P.....J10 | 6304.....C10 |
| 661FHD.....H13 | 1201P.....J12 | 6306.....C10 |
| 664FHD.....H13 | 1202P.....J11 | 6307.....C13 |
| 0670.....L7 | 1203P.....J11 | 6315.....C7 |
| 0671.....L7 | 1204P.....J11 | 6316.....C7 |
| 0672.....L8 | 1295HB.....I11 | 6322.....C13 |
| 0673.....L7 | 01300.....I15 | 6325.....C8 |
| 0674.....L8 | 01400-xx.....I15 | 6326.....C13 |
| 0676.....L8 | 1495F.....H11 | 6340.....C11 |
| 0677.....L7 | 01500.....I15 | 6351.....C12 |
| 0682.....L8 | 1595F.....H12 | 6366.....C11 |
| 682C.....G11 | 01600.....I15 | 6380.....C13 |
| 682CA.....G16 | 01640.....I15 | 6382.....C12 |
| 682VL.....F21 | 1695HB.....I12 | 6383.....C12, C13 |
| 0683.....L8 | 1695VLV.....F22 | 6388.....C12 |
| 685HB.....I10 | 01700.....I15 | 6503.....C9, C10 |
| 685VLV.....F21 | 1725HB.....I12 | 6505.....C7 |

A

B

C

D

E

F

G

H

I

J

K

L

M

N

0



| | | |
|-------------------------------|-------------------------|-------------------------|
| 6508 C9 | C8UPMTB E21 | FCMS731 B15 |
| 6509 C8, C9 | CAP C24 | FCMSI731 B16 |
| 6521 C8 | Clip A40 | FCMSP731 B18 |
| 6548 C13 | Copper Tubing L11 | FCMSPI731 B4, B18 |
| 6579 C8 | CR-001 H19 | FCPM832 B21 |
| 07244S I15 | CU C24 | FE C25, C34 |
| 7800/7801 B41 | DB A16 | FF C24 |
| 7805/7806 B41 | DC601 K68 | GR C35 |
| 7810 B27 | DC602 K69 | HPMTB , E21 |
| 7812 B27 | DC603 K69 | HV104C K65 |
| 7815 B27 | DC604 K69 | HV104C-kit K65 |
| 7817 B27 | DC606 K69 | JPMTB , E21 |
| 7835 B27 | DC607 K69 | LSR-Stand L10 |
| 7892 B34 | DCR601 K69 | LV91 F24 |
| 7894 B34 | ERHD E18 | MC C19, C33 |
| 7970 B37 | ES E18 | MCVC C27 |
| 7982 B37 | EU C19, C33 | ME C23, C33 |
| A613 E23 | F2PMTB , E21 | MES C20 |
| A614 E23 | F3HG J14 | MR C34 |
| A623 E23 | F8UPMTB , E21 | MRS C20 |
| A624 E23 | FA C20 | MT C34 |
| ACT-P-X-KIT K53 | FC C22, C34 | MTS C21 |
| ACT-SS-X-KIT K53 | FC601 B39 | MV200 K42 |
| ADJ-CB L9 | FC602 B39 | MV308 B45 |
| AQRT A41, C30, E11, E19 | FC608 B39 | MV309 B45 |
| AS C9 | FC701 B23 | MV608 K42 |
| AVC1 H18 | FC702 B23 | MV609 K42 |
| AVE1 H18 | FC703 B24, B25 | MV708 K40 |
| AVT3 H18 | FC705 B23 | MV709 K40 |
| AVTS H18 | FC708 B23 | MVV308 B45 |
| AVTS4 H19 | FC731 B8 | MVV309 B45 |
| AVTS6 H19 | FC832 B20 | NS C35 |
| AVU1 H18 | FC836 B21 | NV101F K65 |
| AVU2 H18 | FCB832 , B20 | NV102F K65 |
| AVU2BH H18 | FCC731 , B8 | NV103F K65 |
| AVUIFI H18 | FCCB731 B9 | NV104C K65 |
| AVUR3 H18 | FCCI731 B8 | NV104CA K65 |
| AVUS H19 | FCCS731 B15, B16 | NV105C K65 |
| AVUS3 H19 | FCCSP731 B18 | NV105CA K65 |
| AVUS4D H19 | FCCSPI731 B18 | NV106C K66 |
| Avuse H18 | FCI701 B23 | NV106CA K66 |
| BG441-NBL L6 | FCI702 B23 | NV107P K66 |
| BG442-SBL L6 | FCK701C B23 | NV108P K66 |
| BG443-NBL L6 | FCKC731 , B9 | NV109P K66 |
| BG444-SBL L6 | FCKCB731 B10 | NV311P G34, K66 |
| BU C22, C34 | FCKCI731 , B10 | NV312P G34, K66 |
| BVC , C16, C30 | FCM731 B12 | OR C35 |
| BVG4PLOCK K57 | FCMB731 B13 | PLMC A52, D11 |
| BVGL K55 | FCMI731 B12 | PLSC A60, D11 |
| BVGTL K55 | FCMK731 B13 | Pneu-Cab L11 |

| | | |
|------------------------|-------------------------|------------------------|
| PSBL11 | SAE 060110 G8 | UC C21, C33 |
| PSBJ708B43 | SAE 060111 G8 | US5 H7 |
| PSBJ731B43 | SAE 060115 G8 | V203F K68 |
| PSPE731B43 | SAE 060201 BAG10 | V204F K68 |
| PSPJ731B43 | SAE 060202 BAG10 | V303C K68 |
| PTC-001RB M5 | SAE 060203 BA G11 | V303CA K68 |
| PV607K50 | SAE 060401 BAG10 | V304C K68 |
| PV608K50 | SAE 060424 BA G11 | V304CA K68 |
| PV609K50 | SAE 060425 BA G11 | V401P K68 |
| PVMB-001K50 | SAE 100101 BA F7 | V402P K68 |
| RDC23 | SAE 100102 BA F8 | V403P K68 |
| S8UPMTB E21 | SAE 100103 BA F8 | V404P F24 |
| SAE 010101 H8 | SAE 100110 F7 | V404PH F24 |
| SAE 010102 H9 | SAE 100115 F7 | V405P F24 |
| SAE 010103 H9 | SAE 100201 BA F9 | V406P K68 |
| SAE 010104 H8 | SAE 100202 BA F9 | V407P K68 |
| SAE 010105 H13 | SAE 100203 BA F9 | V408NTA F24 |
| SAE 010106 H13 | SAE 100302 BA F10 | V409F F24 |
| SAE 010107 H13 | SAE 100401 BA F9 | V410NTA F24 |
| SAE 010108 H7 | SAE 100424 BA F9 | V412F F24 |
| SAE 010109 H13 | SAE 100425 BA F10 | V500CS K31 |
| SAE 010110 H8 | SAE 120101 BA F14 | V500CS-X-04 K31 |
| SAE 010111 H8 | SAE 120102 BA F14 | V500CS-X-21 K32 |
| SAE 010112 H13 | SAE 120103 BA F14 | V500HP K35 |
| SAE 010113 H7 | SAE 120111 F14 | V500P K9 |
| SAE 010114 H7 | SAE 120115 F14 | V500P-HB K27 |
| SAE 010165 H7 | SAE 120201 BA F15 | V500P-X-04 K10 |
| SAE 010166 H7 | SAE 120202 BA F15 | V500P-X-21 K10 |
| SAE 010167 H7 | SAE 120203 BA F15 | V501P K11 |
| SAE 010201 H11 | SAE 120302 BA F16 | V501P-X-04 K12 |
| SAE 010202 H10 | SAE 120401 BA F15 | V501P-X-21 K12 |
| SAE 010203 H11 | SAE 120424 BA F15 | V501SS K37 |
| SAE 010302 H12 | SAE 120425 BA F16 | V502CS K31 |
| SAE 010401 H10 | SC C30 | V502CS-X-21 K32 |
| SAE 010424 H11 | SPV104C-kit K65 | V502P K14 |
| SAE 010425 H10 | ST C24 | V502P-X-04 K14 |
| SAE 040101 H15 | STX-P-1-125 K63 | V502P-X-ACT K52 |
| SAE 040102 H15 | STX-P-1-225 K63 | V502P-X-SUB K53 |
| SAE 040103 H15 | SV404P F24 | V502SS K39 |
| SAE 040110 H15 | TAF C24 | V502SS-X-20 K39 |
| SAE 040202 H16 | TC-1000-BPD M5 | V502SS-X-21 K39 |
| SAE 040203 H16 | TCB C24 | V502SS-X-ACT K52 |
| SAE 040302 H16 | TEB C25 | V502SS-X-SUB K53 |
| SAE 040401 H16 | TEU C23 | V506CS K33 |
| SAE 040424 H16 | TFA C24 | V506HP K36 |
| SAE 040425 H16 | TMC C22 | V506P K16 |
| SAE 040427 H16 | TPL A15, C25 | V509P K17 |
| SAE 060101 BA G8 | TS C30 | V510P K19 |
| SAE 060102 BA G9 | TSC C26, D10 | V510P-X-04 K19 |
| SAE 060103 BA G9 | TU C19, C34 | V510P-X-21 K19 |

A

B

C

D

E

F

G

H

I

J

K

L

M

N

0

- A
- B
- C
- D
- E
- F
- G
- H
- I
- J
- K
- L
- M
- N
- 0

| | | | |
|------------------|---|-----------------|----------|
| V533P | K24 | VVP501P | K12 |
| V540P | K24 | VVP502P | K14 |
| V590P | K26 | W68LF | A20, A21 |
| V590P-X-04 | K26 | W68PLCK | B29 |
| V591P | K26 | W68PLCKI | B29 |
| V591P-X-04 | K26 | W68PLP | A9 |
| V600P | K29 | W68PLPSP | A28 |
| V633P | K29 | W169PLP | A11, A12 |
| VAS | C16, K6, K45 | W169PLPNS | A12 |
| VC | B30, C27 | W171PLP | A13 |
| VC-001 | H19 | W172PLP | A14 |
| VEU | C15, C30, K6, K44, K46, K48 | W368PLP | A29 |
| VFC | C29, C27, C36, C15, K6, K45, K46, K47, K48 | W369PLP | A22, A23 |
| VFE | C28, C26, C37, C15, K6, K44, K45, K47, K48 | W369PLPBJ | A30 |
| VMC ... , | C15, C29, K6, K45, K46, K47, K48 | W369PLPO | A43, A18 |
| VME | C14, C28, C37, C44, K6, K44, K45, K47, K48 | W369PLPTJ | A32 |
| VP500CS | K31 | W369PLPX | A24 |
| VP500HP | K35 | W371PLP | A27, A28 |
| VP500P | K9 | W372PLP | A25, A26 |
| VP501P | K12 | W379PLP | A24, A25 |
| VP502CS | K31 | WY | C21 |
| VP502P | K14 | | |
| VP502SS | K39 | | |
| VP510P | K19 | | |
| VS68AB | F14 | | |
| VS68NTA | F8 | | |
| VS68PTCR | E4 | | |
| VS176NTA | F8 | | |
| VS269AB | F15 | | |
| VS269NTA | F9 | | |
| VS271AB | F15 | | |
| VS272AB | F16 | | |
| VS272NTA | F10 | | |
| VS279AB | F16 | | |
| VS279NTA | F10 | | |
| VS368PTCR | E7 | | |
| VS369PTCR | E8 | | |
| VS371PTCR | E9 | | |
| VS372PTCR | E9 | | |
| VTEU | C30, K6, K46 | | |
| VUC ... , | C29, C29, C30, C36, C14, K6, K44, K46, K47, K48 | | |
| VUCPB | C16, C44, K6, K45, K47 | | |
| VV500P | K9 | | |
| VV501P | K12 | | |
| VV502P | K14 | | |
| VVP500P | K9 | | |



Parker Safety Guide for Selecting and Using Hose, Tubing, Fittings, Connectors, Conductors, Valves and Related Accessories

Parker Publication No. 4400-B.1

WARNING: Failure or improper selection or improper use of hose, tubing, fittings, assemblies, valves, connectors, conductors or related accessories (“Products”) can cause death, personal injury and property damage. Possible consequences of failure or improper selection or improper use of these Products include but are not limited to:

- Fittings thrown off at high speed.
- High velocity fluid discharge.
- Explosion or burning of the conveyed fluid.
- Electrocution from high voltage electric powerlines.
- Contact with suddenly moving or falling objects that are controlled by the conveyed fluid.
- Injections by high-pressure fluid discharge.
- Dangerously whipping Hose.
- Tube or pipe burst.
- Weld joint fracture.
- Contact with conveyed fluids that may be hot, cold, toxic or otherwise injurious.
- Sparking or explosion caused by static electricity buildup or other sources of electricity.
- Sparking or explosion while spraying paint or flammable liquids.
- Injuries resulting from inhalation, ingestion or exposure to fluids.

Before selecting or using any of these Products, it is important that you read and follow the instructions below. No product from any division in Fluid Connector Group is approved for in-flight aerospace applications. For hoses and fittings used in in-flight aerospace applications, please contact Parker Aerospace Group

GENERAL INSTRUCTIONS

- 1.0 Scope:** This safety guide provides instructions for selecting and using (including assembling, installing, and maintaining) these Products. For convenience, all rubber and/or thermoplastic products commonly called “hose” or “tubing” are called “Hose” in this safety guide. Metallic tube or pipe are called “tube”. All assemblies made with Hose are called “Hose Assemblies”. All assemblies made with Tube are called “Tube Assemblies”. All products commonly called “fittings”, “couplings” or “adapters” are called “Fittings”. Valves are fluid system components that control the passage of fluid. Related accessories are ancillary devices that enhance or monitor performance including crimping, flaring, flanging, presetting, bending, cutting, deburring, swaging machines, sensors, tags, lockout handles, spring guards and associated tooling. This safety guide is a supplement to and is to be used with the specific Parker publications for the specific Hose, Fittings and Related Accessories that are being considered for use. Parker publications are available at www.parker.com. SAE J1273 (www.sae.org) and ISO 17165-2 (www.ansi.org) also provide recommended practices for hydraulic Hose Assemblies, and should be followed.
- 1.1 Fail-Safe:** Hose, Hose Assemblies, Tube, Tube Assemblies and Fittings can and do fail without warning for many reasons. Design all systems and equipment in a fail-safe mode, so that failure of the Hose, Hose Assembly, Tube, Tube Assembly or Fitting will not endanger persons or property.
- 1.2 Distribution:** Provide a copy of this safety guide to each person responsible for selecting or using Hose, Tube and Fitting products. Do not select or use Parker Hose, Tube or Fittings without thoroughly reading and understanding this safety guide as well as the specific Parker publications for the Products.
- 1.3 User Responsibility:** Due to the wide variety of operating conditions and applications for Hose, Tube and Fittings, Parker does not represent or warrant that any particular Hose, Tube or Fitting is suitable for any specific end use system. This safety guide does not analyze all technical parameters that must be considered in selecting a product. The user, through its own analysis and testing, is solely responsible for:
- Making the final selection of the Products.
 - Assuring that the user’s requirements are met and that the application presents no health or safety hazards.
 - Following the safety guide for Related Accessories and being trained to operate Related Accessories.
 - Providing all appropriate health and safety warnings on the equipment on which the Products are used.
 - Assuring compliance with all applicable government and industry standards.
- 1.4 Additional Questions:** Call the appropriate Parker technical service department if you have any questions or require any additional information. See the Parker publication for the Products being considered or used, or call 1-800-CPARKER, or go to www.parker.com, for telephone numbers of the appropriate technical service department.

2.0 HOSE, TUBE AND FITTINGS SELECTION INSTRUCTIONS

- 2.1 Electrical Conductivity:** Certain applications require that the Hose be nonconductive to prevent electrical current flow. Other applications require the Hose and the Fittings and the Hose/Fitting interface to be sufficiently conductive to drain off static electricity. Extreme care must be exercised when selecting Hose, Tube and Fittings for these or any other applications in which electrical conductivity or nonconductivity is a factor.
- The electrical conductivity or nonconductivity of Hose, Tube and Fittings is dependent upon many factors and may be susceptible to change. These factors include but are not limited to the various materials used to make the Hose and the Fittings, Fitting finish (some Fitting finishes are electrically conductive while others are nonconductive), manufacturing methods (including moisture control), how the Fittings contact the Hose, age and amount of deterioration or damage or other changes, moisture content of the Hose at any particular time, and other factors.
- The following are considerations for electrically nonconductive and conductive Hose. For other applications consult the individual catalog pages and the appropriate industry or regulatory standards for proper selection.
- 2.1.1 Electrically Nonconductive Hose:** Certain applications require that the

Hose be nonconductive to prevent electrical current flow or to maintain electrical isolation. For applications that require Hose to be electrically nonconductive, including but not limited to applications near high voltage electric lines, only special nonconductive Hose can be used. The manufacturer of the equipment in which the nonconductive Hose is to be used must be consulted to be certain that the Hose, Tube and Fittings that are selected are proper for the application. Do not use any Parker Hose or Fittings for any such application requiring nonconductive Hose, including but not limited to applications near high voltage electric lines or dense magnetic fields, unless (i) the application is expressly approved in the Parker technical publication for the product, (ii) the Hose is marked “nonconductive”, and (iii) the manufacturer of the equipment on which the Hose is to be used specifically approves the particular Parker Hose, Tube and Fittings for such use.

- 2.1.2 Electrically Conductive Hose:** Parker manufactures special Hose for certain applications that require electrically conductive Hose. Parker manufactures special Hose for conveying paint in airless paint spraying applications. This Hose is labeled “Electrically Conductive Airless Paint Spray Hose” on its layline and packaging. This Hose must be properly connected to the appropriate Parker Fittings and properly grounded in order to dissipate dangerous static charge buildup, which occurs in all airless paint spraying applications. Do not use any other Hose for airless paint spraying, even if electrically conductive. Use of any other Hose or failure to properly connect the Hose can cause a fire or an explosion resulting in death, personal injury, and property damage. All hoses that convey fuels must be grounded. Parker manufactures a special Hose for certain compressed natural gas (“CNG”) applications where static electricity buildup may occur. Parker CNG Hose assemblies comply with the requirements of ANSI/IAS NGV 4.2; CSA 12.52, “Hoses for Natural Gas Vehicles and Dispensing Systems” (www.ansi.org). This Hose is labeled “Electrically Conductive for CNG Use” on its layline and packaging. This Hose must be properly connected to the appropriate Parker Fittings and properly grounded in order to dissipate dangerous static charge buildup, which occurs in, for example, high velocity CNG dispensing or transfer. Do not use any other Hose for CNG applications where static charge buildup may occur, even if electrically conductive. Use of other Hoses in CNG applications or failure to properly connect or ground this Hose can cause a fire or an explosion resulting in death, personal injury, and property damage. Care must also be taken to protect against CNG permeation through the Hose wall. See section 2.6, Permeation, for more information. Parker CNG Hose is intended for dispenser and vehicle use within the specified temperature range. Parker CNG Hose should not be used in confined spaces or unventilated areas or areas exceeding the specified temperature range. Final assemblies must be tested for leaks. CNG Hose Assemblies should be tested on a monthly basis for conductivity per ANSI/IAS NGV 4.2; CSA 12.52. Parker manufactures special Hose for aerospace in-flight applications. Aerospace in-flight applications employing Hose to transmit fuel, lubricating fluids and hydraulic fluids require a special Hose with a conductive inner tube. This Hose for in-flight applications is available only from Parker’s Stratoflex Products Division. Do not use any other Parker Hose for in-flight applications, even if electrically conductive. Use of other Hoses for in-flight applications or failure to properly connect or ground this Hose can cause a fire or an explosion resulting in death, personal injury and property damage. These Hose assemblies for in-flight applications must meet all applicable aerospace industry, aircraft engine and aircraft requirements.

- 2.2 Pressure:** Hose, Tube and Fitting selection must be made so that the published maximum working pressure of the Hose, Tube and Fittings are equal to or greater than the maximum system pressure. The maximum working pressure of a Hose, or Tube Assembly is the lower of the respective published maximum working pressures of the Hose, Tube and the Fittings used. Surge pressures or peak transient pressures in the system must be below the published maximum working pressure for the Hose, Tube and Fitting. Surge pressures and peak pressures can usually only be determined by sensitive electrical instrumentation that measures and indicates pressures at millisecond intervals. Mechanical pressure gauges indicate only average pressures and cannot be used to

- determine surge pressures or peak transient pressures. Published burst pressure ratings for Hose is for manufacturing test purposes only and is no indication that the Product can be used in applications at the burst pressure or otherwise above the published maximum recommended working pressure.
- 2.3 Suction:** Hoses used for suction applications must be selected to insure that the Hose will withstand the vacuum and pressure of the system. Improperly selected Hose may collapse in suction application.
- 2.4 Temperature:** Be certain that fluid and ambient temperatures, both steady and transient, do not exceed the limitations of the Hose, Tube, Fitting and Seals. Temperatures below and above the recommended limit can degrade Hose, Tube, Fittings and Seals to a point where a failure may occur and release fluid. Tube and Fittings performances are normally degraded at elevated temperature. Material compatibility can also change at temperatures outside of the rated range. Properly insulate and protect the Hose Assembly when routing near hot objects (e.g. manifolds). Do not use any Hose in any application where failure of the Hose could result in the conveyed fluids (or vapors or mist from the conveyed fluids) contacting any open flame, molten metal, or other potential fire ignition source that could cause burning or explosion of the conveyed fluids or vapors.
- 2.5 Fluid Compatibility:** Hose, and Tube Assembly selection must assure compatibility of the Hose tube, cover, reinforcement, Tube, Plating and Seals with the fluid media used. See the fluid compatibility chart in the Parker publication for the product being considered or used. This information is offered only as a guide. Actual service life can only be determined by the end user by testing under all extreme conditions and other analysis. Hose, and Tube that is chemically compatible with a particular fluid must be assembled using Fittings and adapters containing likewise compatible seals. Flange or flare processes can change Tube material properties that may not be compatible with certain requirements such as NACE
- 2.6 Permeation:** Permeation (that is, seepage through the Hose or Seal) will occur from inside the Hose or Fitting to outside when Hose or Fitting is used with gases, liquid and gas fuels, and refrigerants (including but not limited to such materials as helium, diesel fuel, gasoline, natural gas, or LPG). This permeation may result in high concentrations of vapors which are potentially flammable, explosive, or toxic, and in loss of fluid. Dangerous explosions, fires, and other hazards can result when using the wrong Hose for such applications. The system designer must take into account the fact that this permeation will take place and must not use Hose or Fitting if this permeation could be hazardous. The system designer must take into account all legal, government, insurance, or any other special regulations which govern the use of fuels and refrigerants. Never use a Hose or Fitting even though the fluid compatibility is acceptable without considering the potential hazardous effects that can result from permeation through the Hose or Tube Assembly. Permeation of moisture from outside the Hose or Fitting to inside the Hose or Fitting will also occur in Hose or Tube assemblies, regardless of internal pressure. If this moisture permeation would have detrimental effects (particularly, but not limited to refrigeration and air conditioning systems), incorporation of sufficient drying capacity in the system or other appropriate system safeguards should be selected and used. The sudden pressure release of highly pressurized gas could also result in Explosive Decompression failure of permeated Seals and Hoses.
- 2.7 Size:** Transmission of power by means of pressurized fluid varies with pressure and rate of flow. The size of the components must be adequate to keep pressure losses to a minimum and avoid damage due to heat generation or excessive fluid velocity.
- 2.8 Routing:** Attention must be given to optimum routing to minimize inherent problems (kinking or flow restriction due to Hose collapse, twisting of the Hose, proximity to hot objects or heat sources). For additional routing recommendations see SAE J1273 and ISO 17165-2. Hose Assemblies have a finite life and should be installed in a manner that allows for ease of inspection and future replacement. Hose because of its relative short life, should not be used in residential and commercial buildings inside of inaccessible walls or floors, unless specifically allowed in the product literature. Always review all product literature for proper installation and routing instructions.
- 2.9 Environment:** Care must be taken to insure that the Hose, Tube and Fittings are either compatible with or protected from the environment (that is, surrounding conditions) to which they are exposed. Environmental conditions including but not limited to ultraviolet radiation, sunlight, heat, ozone, moisture, water, salt water, chemicals and air pollutants can cause degradation and premature failure.
- 2.10 Mechanical Loads:** External forces can significantly reduce Hose, Tube and Fitting life or cause failure. Mechanical loads which must be considered include excessive flexing, twist, kinking, tensile or side loads, bend radius, and vibration. Use of swivel type Fittings or adapters may be required to insure no twist is put into the Hose. Use of proper Hose or Tube clamps may also be required to reduce external mechanical loads. Unusual applications may require special testing prior to Hose selection.
- 2.11 Physical Damage:** Care must be taken to protect Hose from wear, snagging, kinking, bending smaller than minimum bend radius and cutting, any of which can cause premature Hose failure. Any Hose that has been kinked or bent to a radius smaller than the minimum bend radius, and any Hose that has been cut or is cracked or is otherwise damaged should be removed and discarded. Fittings with damages such as scratches on sealing surfaces and deformation should be replaced.
- 2.12 Proper End Fitting:** See instructions 3.2 through 3.5. These recommendations may be substantiated by testing to industry standards such as SAE J517 for hydraulic applications, or MIL-A-5070, AS1339, or AS3517 for Hoses from Parker's Stratoflex Products Division for aerospace applications.
- 2.13 Length:** When determining the proper Hose or Tube length of an assembly, be aware of Hose length change due to pressure, Tube length change due to thermal expansion or contraction, and Hose or Tube and machine tolerances and movement must be considered. When routing short hose assemblies, it is recommended that the minimum free hose length is always used. Consult the hose manufacturer for their minimum free hose length recommendations.

Hose assemblies should be installed in such a way that any motion or flexing occurs within the same plane.

- 2.14 Specifications and Standards:** When selecting Hose, Tube and Fittings, government, industry, and Parker specifications and recommendations must be reviewed and followed as applicable.
- 2.15 Hose Cleanliness:** Hose and Tube components may vary in cleanliness levels. Care must be taken to insure that the Hose and Tube Assembly selected has an adequate level of cleanliness for the application.
- 2.16 Fire Resistant Fluids:** Some fire resistant fluids that are to be conveyed by Hose or Tube require use of the same type of Hose or Tube as used with petroleum base fluids. Some such fluids require a special Hose, Tube, Fitting and Seal, while a few fluids will not work with any Hose at all. See instructions 2.5 and 1.5. The wrong Hose, Tube, Fitting or Seal may fail after a very short service. In addition, all liquids but pure water may burn fiercely under certain conditions, and even pure water leakage may be hazardous.
- 2.17 Radiant Heat:** Hose and Seals can be heated to destruction without contact by such nearby items as hot manifolds or molten metal. The same heat source may then initiate a fire. This can occur despite the presence of cool air around the Hose or Seal. Performance of Tube and Fitting subjected to the heat could be degraded.
- 2.18 Welding or Brazing:** When using a torch or arc welder in close proximity to hydraulic lines, the hydraulic lines should be removed or shielded with appropriate fire resistant materials. Flame or weld spatter could burn through the Hose or Seal and possibly ignite escaping fluid resulting in a catastrophic failure. Heating of plated parts, including Hose Fittings and adapters, above 450°F (232°C) such as during welding, brazing or soldering may emit deadly gases. Any elastomer seal on fittings shall be removed prior to welding or brazing, any metallic surfaces shall be protected after brazing or welding when necessary. Welding and brazing filler material shall be compatible with the Tube and Fitting that are joined.
- 2.19 Atomic Radiation:** Atomic radiation affects all materials used in Hose and Tube assemblies. Since the long-term effects may be unknown, do not expose Hose or Tube assemblies to atomic radiation. Nuclear applications may require special Tube and Fittings.
- 2.20 Aerospace Applications:** The only Hose, Tube and Fittings that may be used for in-flight aerospace applications are those available from Parker's Stratoflex Products Division. Do not use any other Hose or Fittings for in-flight applications. Do not use any Hose or Fittings from Parker's Stratoflex Products Division with any other Hose or Fittings, unless expressly approved in writing by the engineering manager or chief engineer of Stratoflex Products Division and verified by the user's own testing and inspection to aerospace industry standards.
- 2.21 Unlocking Couplings:** Ball locking couplings or other Fittings with quick disconnect ability can unintentionally disconnect if they are dragged over obstructions, or if the sleeve or other disconnect member, is bumped or moved enough to cause disconnect. Threaded Fittings should be considered where there is a potential for accidental uncoupling.

3.0 HOSE AND FITTINGS ASSEMBLY AND INSTALLATION INSTRUCTIONS

- 3.1 Component Inspection:** Prior to assembly, a careful examination of the Hose and Fittings must be performed. All components must be checked for correct style, size, catalog number, and length. The Hose must be examined for cleanliness, obstructions, blisters, cover looseness, kinks, cracks, cuts or any other visible defects. Inspect the Fitting and sealing surfaces for burrs, nicks, corrosion or other imperfections. Do NOT use any component that displays any signs of nonconformance.
- 3.2 Hose and Fitting Assembly:** Do not assemble a Parker Fitting on a Parker Hose that is not specifically listed by Parker for that Fitting, unless authorized in writing by the engineering manager or chief engineer of the appropriate Parker division. Do not assemble a Parker Fitting on another manufacturer's Hose or a Parker Hose on another manufacturer's Fitting unless (i) the engineering manager or chief engineer of the appropriate Parker division approves the Assembly in writing or that combination is expressly approved in the appropriate Parker literature for the specific Parker product, and (ii) the user verifies the Assembly and the application through analysis and testing. For Parker Hose that does not specify a Parker Fitting, the user is solely responsible for the selection of the proper Fitting and Hose Assembly procedures. See instruction 1.4. To prevent the possibility of problems such as leakage at the Fitting or system contamination, it is important to completely remove all debris from the cutting operation before installation of the Fittings. The Parker published instructions must be followed for assembling the Fittings on the Hose. These instructions are provided in the Parker Fitting catalog for the specific Parker Fitting being used, or by calling 1-800-CPARKER, or at www.parker.com.
- 3.3 Related Accessories:** Do not crimp or swage any Parker Hose or Fitting with anything but the listed swage or crimp machine and dies in accordance with Parker published instructions. Do not crimp or swage another manufacturer's Fitting with a Parker crimp or swage die unless authorized in writing by the engineering manager or chief engineer of the appropriate Parker division.
- 3.4 Parts:** Do not use any Parker Fitting part (including but not limited to socket, shell, nipple, or insert) except with the correct Parker mating parts, in accordance with Parker published instructions, unless authorized in writing by the engineering manager or chief engineer of the appropriate Parker division.
- 3.5 Field Attachable/Permanent:** Do not reuse any field attachable Hose Fitting that has blown or pulled off a Hose. Do not reuse a Parker permanent Hose Fitting (crimped or swaged) or any part thereof. Complete Hose Assemblies may only be reused after proper inspection under section 4.0. Do not assemble Fittings to any previously used hydraulic Hose that was in service, for use in a fluid power application.
- 3.6 Pre-Installation Inspection:** Prior to installation, a careful examination of the Hose Assembly must be performed. Inspect the Hose Assembly for any damage or defects. DO NOT use any Hose Assembly that displays any signs

- of nonconformance.
- 3.7 **Minimum Bend Radius:** Installation of a Hose at less than the minimum listed bend radius may significantly reduce the Hose life. Particular attention must be given to preclude sharp bending at the Hose to Fitting juncture. Any bending during installation at less than the minimum bend radius must be avoided. If any Hose is kinked during installation, the Hose must be discarded.
- 3.8 **Twist Angle and Orientation:** Hose Assembly installation must be such that relative motion of machine components does not produce twisting.
- 3.9 **Securement:** In many applications, it may be necessary to restrain, protect, or guide the Hose to protect it from damage by unnecessary flexing, pressure surges, and contact with other mechanical components. Care must be taken to insure such restraints do not introduce additional stress or wear points.
- 3.10 **Proper Connection of Ports:** Proper physical installation of the Hose Assembly requires a correctly installed port connection insuring that no twist or torque is transferred to the Hose when the Fittings are being tightened or otherwise during use.
- 3.11 **External Damage:** Proper installation is not complete without insuring that tensile loads, side loads, kinking, flattening, potential abrasion, thread damage or damage to sealing surfaces are corrected or eliminated. See instruction 2.10.
- 3.12 **System Checkout:** All air entrapment must be eliminated and the system pressurized to the maximum system pressure (at or below the Hose maximum working pressure) and checked for proper function and freedom from leaks. Personnel must stay out of potential hazardous areas while testing and using.
- 3.13 **Routing:** The Hose Assembly should be routed in such a manner so if a failure does occur, the escaping media will not cause personal injury or property damage. In addition, if fluid media comes in contact with hot surfaces, open flame or sparks, a fire or explosion may occur. See section 2.4.
- 3.14 **Ground Fault Equipment Protection Devices (GFEEDs):** **WARNING! Fire and Shock Hazard.** To minimize the danger of fire if the heating cable of a Multitube bundle is damaged or improperly installed, use a Ground Fault Equipment Protection Device. Electrical fault currents may be insufficient to trip a conventional circuit breaker. For ground fault protection, the IEEE 515: (www.ansi.org) standard for heating cables recommends the use of GFEEDs with a nominal 30 milliamperere trip level for "piping systems in classified areas, those areas requiring a high degree of maintenance, or which may be exposed to physical abuse or corrosive atmospheres".
- 4.0 TUBE AND FITTINGS ASSEMBLY AND INSTALLATION INSTRUCTIONS**
- 4.1 **Component Inspection:** Prior to assembly, a careful examination of the Tube and Fittings must be performed. All components must be checked for correct style, size, material, seal, and length. Inspect the Fitting and sealing surfaces for burrs, nicks, corrosion, missing seal or other imperfections. Do NOT use any component that displays any signs of nonconformance.
- 4.2 **Tube and Fitting Assembly:** Do not assemble a Parker Fitting with a Tube that is not specifically listed by Parker for that Fitting, unless authorized in writing by the engineering manager or chief engineer of the appropriate Parker division. The Tube must meet the requirements specified to the Fitting. The Parker published instructions must be followed for assembling the Fittings to a Tube. These instructions are provided in the Parker Fitting catalog for the specific Parker Fitting being used, or by calling 1-800-CPARKER, or at www.parker.com.
- 4.3 **Related Accessories:** Do not preset or flange Parker Fitting components using another manufacturer's equipment or procedures unless authorized in writing by the engineering manager or chief engineer of the appropriate Parker division. Tube, Fitting component and tooling must be checked for correct style, size and material. Operation and maintenance of Related Accessories must be in accordance with the operation manual for the designated Accessory.
- 4.4 **Securement:** In many applications, it may be necessary to restrain, protect, or guide the Tube to protect it from damage by unnecessary flexing, pressure surges, vibration, and contact with other mechanical components. Care must be taken to insure such restraints do not introduce additional stress or wear points.
- 4.5 **Proper Connection of Ports:** Proper physical installation of the Tube Assembly requires a correctly installed port connection insuring that no torque is transferred to the Tube when the Fittings are being tightened or otherwise during use.
- 4.6 **External Damage:** Proper installation is not complete without insuring that tensile loads, side loads, flattening, potential abrasion, thread damage or damage to sealing surfaces are corrected or eliminated. See instruction 2.10.
- 4.7 **System Checkout:** All air entrapment must be eliminated and the system pressurized to the maximum system pressure (at or below the Tube Assembly maximum working pressure) and checked for proper function and freedom from leaks. Personnel must stay out of potential hazardous areas while testing and using.
- 4.8 **Routing:** The Tube Assembly should be routed in such a manner so if a failure does occur, the escaping media will not cause personal injury or property damage. In addition, if fluid media comes in contact with hot surfaces, open flame or sparks, a fire or explosion may occur. See section 2.4.
- 5.0 HOSE AND FITTING MAINTENANCE AND REPLACEMENT INSTRUCTIONS**
- 5.1 Even with proper selection and installation, Hose life may be significantly reduced without a continuing maintenance program. The severity of the application, risk potential from a possible Hose failure, and experience with any Hose failures in the application or in similar applications should determine the frequency of the inspection and the replacement for the Products so that Products are replaced before any failure occurs. Certain products require maintenance and inspection per industry requirements. Failure to adhere to these requirements may lead to premature failure. A maintenance program must be established and followed by the user and, at minimum, must include instructions 5.2 through 5.7
- 5.2 **Visual Inspection Hose/Fitting:** Any of the following conditions require immediate shut down and replacement of the Hose Assembly:
- Fitting slippage on Hose;
 - Damaged, cracked, cut or abraded cover (any reinforcement exposed);
 - Hard, stiff, heat cracked, or charred Hose;
 - Cracked, damaged, or badly corroded Fittings;
 - Leaks at Fitting or in Hose;
 - Kinked, crushed, flattened or twisted Hose; and
 - Blistered, soft, degraded, or loose cover.
- 5.3 **Visual Inspection All Other:** The following items must be tightened, repaired, corrected or replaced as required:
- Leaking port conditions;
 - Excess dirt buildup;
 - Worn clamps, guards or shields; and
 - System fluid level, fluid type, and any air entrapment.
- 5.4 **Functional Test:** Operate the system at maximum operating pressure and check for possible malfunctions and leaks. Personnel must avoid potential hazardous areas while testing and using the system. See section 2.2.
- 5.5 **Replacement Intervals:** Hose assemblies and elastomeric seals used on Hose Fittings and adapters will eventually age, harden, wear and deteriorate under thermal cycling and compression set. Hose Assemblies and elastomeric seals should be inspected and replaced at specific replacement intervals, based on previous service life, government or industry recommendations, or when failures could result in unacceptable downtime, damage, or injury risk. See section 1.2. Hose and Fittings may be subjected to internal mechanical and/or chemical wear from the conveying fluid and may fail without warning. The user must determine the product life under such circumstances by testing. Also see section 2.5.
- 5.6 **Hose Inspection and Failure:** Hydraulic power is accomplished by utilizing high pressure fluids to transfer energy and do work. Hoses, Fittings and Hose Assemblies all contribute to this by transmitting fluids at high pressures. Fluids under pressure can be dangerous and potentially lethal and, therefore, extreme caution must be exercised when working with fluids under pressure and handling the Hoses transporting the fluids. From time to time, Hose Assemblies will fail if they are not replaced at proper time intervals. Usually these failures are the result of some form of misapplication, abuse, wear or failure to perform proper maintenance. When Hoses fail, generally the high pressure fluids inside escape in a stream which may or may not be visible to the user. Under no circumstances should the user attempt to locate the leak by "feeling" with their hands or any other part of their body. High pressure fluids can and will penetrate the skin and cause severe tissue damage and possibly loss of limb. Even seemingly minor hydraulic fluid injection injuries must be treated immediately by a physician with knowledge of the tissue damaging properties of hydraulic fluid. If a Hose failure occurs, immediately shut down the equipment and leave the area until pressure has been completely released from the Hose Assembly. Simply shutting down the hydraulic pump may or may not eliminate the pressure in the Hose Assembly. Many times check valves, etc., are employed in a system and can cause pressure to remain in a Hose Assembly even when pumps or equipment are not operating. Tiny holes in the Hose, commonly known as pinholes, can eject small, dangerously powerful but hard to see streams of hydraulic fluid. It may take several minutes or even hours for the pressure to be relieved so that the Hose Assembly may be examined safely. Once the pressure has been reduced to zero, the Hose Assembly may be taken off the equipment and examined. It must always be replaced if a failure has occurred. Never attempt to patch or repair a Hose Assembly that has failed. Consult the nearest Parker distributor or the appropriate Parker division for Hose Assembly replacement information. Never touch or examine a failed Hose Assembly unless it is obvious that the Hose no longer contains fluid under pressure. The high pressure fluid is extremely dangerous and can cause serious and potentially fatal injury.
- 5.7 **Elastomeric seals:** Elastomeric seals will eventually age, harden, wear and deteriorate under thermal cycling and compression set. Elastomeric seals should be inspected and replaced.
- 5.8 **Refrigerant gases:** Special care should be taken when working with refrigeration systems. Sudden escape of refrigerant gases can cause blindness if the escaping gases contact the eye and can cause freezing or other severe injuries if it contacts any other portion of the body.
- 5.9 **Compressed natural gas (CNG):** Parker CNG Hose Assemblies should be tested after installation and before use, and at least on a monthly basis per instructions provided on the Hose Assembly tag. The recommended procedure is to pressurize the Hose and check for leaks and to visually inspect the Hose for damage and to perform an electrical resistance test. Caution: Matches, candles, open flame or other sources of ignition shall not be used for Hose inspection. Leak check solutions should be rinsed off after use.
- 6.0 HOSE STORAGE**
- 6.1 **Age Control:** Hose and Hose Assemblies must be stored in a manner that facilitates age control and first-in and first-out usage based on manufacturing date of the Hose and Hose Assemblies. Unless otherwise specified by the manufacturer or defined by local laws and regulations:
- 6.1.1 The shelf life of rubber hose in bulk form or hose made from two or more materials is 28 quarters (7 years) from the date of manufacture, with an extension of 12 quarters (3 years), if stored in accordance with ISO 2230;
- 6.1.2 The shelf life of thermoplastic and polytetrafluoroethylene hose is considered to be unlimited;
- 6.1.3 Hose assemblies that pass visual inspection and proof test shall not be stored for longer than 2 years.
- 6.1.4 **Storage:** Stored Hose and Hose Assemblies must not be subjected to damage that could reduce their expected service life and must be placed in a cool, dark and dry area with the ends capped. Stored Hose and Hose Assemblies must not be exposed to temperature extremes, ozone, oils, corrosive liquids or fumes, solvents, high humidity, rodents, insects, ultraviolet light, electromagnetic fields or radioactive materials.

PARKER-HANNIFIN CORPORATION OFFER OF SALE

1. **Definitions.** As used herein, the following terms have the meanings indicated.

“Buyer” means any customer receiving a Quote for Products.

“Buyer’s Property” means any tools, patterns, plans, drawings, designs, specifications materials, equipment, or information furnished by Buyer, or which are or become Buyer’s property.

“Confidential Information” means any technical, commercial, or other proprietary information of Seller, including, without limitation, pricing, technical drawings or prints and/or part lists, which has been or will be disclosed, delivered, or made available, whether directly or indirectly, to Buyer.

“Goods” means any tangible part, system or component to be supplied by Seller.

“Intellectual Property Rights” means any patents, trademarks, copyrights, trade dress, trade secrets or similar rights.

“Products” means the Goods, Services and/or Software as described in a Quote.

“Quote” means the offer or proposal made by Seller to Buyer for the supply of Products.

“Seller” means Parker-Hannifin Corporation, including all divisions, subsidiaries and businesses selling Products under these Terms.

“Seller’s IP” means patents, trademarks, copyrights, or other intellectual property rights relating to the Products, including without limitation, names, designs, images, drawings, models, software, templates, information, any improvements or creations or other intellectual property developed prior to or during the relationship contemplated herein.

“Services” means any services to be provided by Seller.

“Software” means any software related to the Goods, whether embedded or separately downloaded.

“Special Tooling” means equipment acquired by Seller or otherwise owned by Seller necessary to manufacture Goods, including but not limited to tools, jigs, and fixtures.

“Terms” means the terms and conditions of this Offer of Sale.

2. **Terms.** All sales of Products by Seller will be governed by, and are expressly conditioned upon Buyer’s assent to, these Terms. These Terms are incorporated into any Quote provided by Seller to Buyer. Buyer’s order for any Products whether communicated to Seller verbally, in writing, by electronic data interface or other electronic commerce, shall constitute acceptance of these Terms. Seller objects to any contrary or additional terms or conditions of Buyer. Reference in Seller’s order acknowledgement to Buyer’s purchase order or purchase order number shall in no way constitute an acceptance of any of Buyer’s terms or conditions of purchase. Any Quote made by Seller to Buyer shall be considered a firm and definite offer and shall not be deemed to be otherwise despite any language on the face of the Quote. Seller reserves all rights to accept or reject any purported acceptance by Buyer to Seller’s Quote if such purported acceptance attempts to vary the terms of the Quote. If Seller ships Products after Buyer issues an acceptance to the Quote, any additional or different terms proposed by Buyer will not become part of the parties’ business relationship unless agreed to in a writing that is signed by an authorized representative of Seller, excluding email correspondence. If the transaction proceeds without such agreement on the part of Seller, the business relationship will be governed solely by these Terms and the specific terms in Seller’s Quote.

3. **Price; Payment.** The Products set forth in the Quote are offered for sale at the prices indicated in the Quote. Unless otherwise specifically stated in the Quote, prices are valid for thirty (30) days and do not include any sales, use, or other taxes or duties. Seller reserves the right to modify prices for any reason and at any time by giving ten (10) days prior written notice. Unless otherwise specified by Seller, all prices are F.C.A. Seller’s facility (INCOTERMS 2020). All sales are contingent upon credit approval and full payment for all purchases is due thirty (30) days from the date of invoice (or such date as may be specified in the Quote). Under any circumstances, Buyer may not withhold or suspend payment of any amounts due and payable as a deduction, set-off or recoupment of any amount, claim or dispute with Seller. Unpaid invoices beyond the specified payment date incur interest at the rate of 1.5% per month or

the maximum allowable rate under applicable law. Seller reserves the right to require advance payment or provision of securities for first and subsequent deliveries if there is any doubt, in Seller’s sole determination, regarding the Buyer’s creditworthiness or for other business reasons. If the requested advance payment or securities are not provided to Seller’s satisfaction, Seller reserves the right to suspend performance or reject the purchase order, in whole or in part, without prejudice to Seller’s other rights or remedies, including the right to full compensation. Seller may revoke or shorten any payment periods previously granted in Seller’s sole determination. The rights and remedies herein reserved to Seller are cumulative and in addition to any other or further rights and remedies available at law or in equity. No waiver by Seller of any breach by Buyer of any provision of these terms will constitute a waiver by Seller of any other breach of such provision.

4. **Shipment; Delivery; Title and Risk of Loss.** All delivery dates are approximate, and Seller is not responsible for damages or additional costs resulting from any delay. All deliveries are subject to our ability to procure materials from our suppliers. Regardless of the manner of shipment, delivery occurs and title and risk of loss or damage pass to Buyer, upon placement of the Products with the carrier at Seller’s facility. Unless otherwise agreed prior to shipment and for domestic delivery locations only, Seller will select and arrange, at Buyer’s sole expense, the carrier and means of delivery. When Seller selects and arranges the carrier and means of delivery, freight and insurance costs for shipment to the designated delivery location will be prepaid by Seller and added as a separate line item to the invoice. Buyer shall be responsible for any additional shipping charges incurred by Seller due to Buyer’s acts or omissions. Buyer shall not return or repackage any Products without the prior written authorization from Seller, and any return shall be at the sole cost and expense of Buyer.

5. **Warranty.** The warranty for the Products is as follows: (i) Goods are warranted against defects in material or workmanship for a period of twelve (12) months from the date of delivery or 2,000 hours of use, whichever occurs first; (ii) Services shall be performed in accordance with generally accepted practices and using the degree of care and skill that is ordinarily exercised and customary in the field to which the Services pertain and are warranted for a period of six (6) months from the date of completion of the Services; and (iii) Software is only warranted to perform in accordance with applicable specifications provided by Seller to Buyer for ninety (90) days from the date of delivery or, when downloaded by a Buyer or end-user, from the date of the initial download. All prices are based upon the exclusive limited warranty stated above, and upon the following disclaimer: **EXEMPTION CLAUSE; DISCLAIMER OF WARRANTY, CONDITIONS, REPRESENTATIONS: THIS WARRANTY IS THE SOLE AND ENTIRE WARRANTY, CONDITION, AND REPRESENTATION, PERTAINING TO PRODUCTS. SELLER DISCLAIMS ALL OTHER WARRANTIES, CONDITIONS, AND REPRESENTATIONS, WHETHER STATUTORY, EXPRESS OR IMPLIED, INCLUDING BUT NOT LIMITED TO THOSE RELATING TO DESIGN, NONINFRINGEMENT, MERCHANTABILITY, AND FITNESS FOR A PARTICULAR PURPOSE. SELLER DOES NOT WARRANT THAT THE SOFTWARE IS ERROR-FREE OR FAULT-TOLERANT, OR THAT BUYER’S USE THEREOF WILL BE SECURE OR UNINTERRUPTED, UNLESS OTHERWISE AUTHORIZED IN WRITING BY SELLER, THE SOFTWARE SHALL NOT BE USED IN CONNECTION WITH HAZARDOUS OR HIGH-RISK ACTIVITIES OR ENVIRONMENTS. EXCEPT AS EXPRESSLY STATED HEREIN, ALL PRODUCTS ARE PROVIDED “AS IS”.**

6. **Claims; Commencement of Actions.** Buyer shall promptly inspect all Products upon receipt. No claims for shortages will be allowed unless reported to Seller within ten (10) days of delivery. Buyer shall notify Seller of any alleged breach of warranty within thirty (30) days after the date the non-conformance is or should have been discovered by Buyer. Any claim or action against Seller based upon breach of contract or any other theory, including tort, negligence, or otherwise must be commenced within twelve (12) months from the date of the alleged breach or other alleged event, without regard to the date of discovery.

7. LIMITATION OF LIABILITY. IN THE EVENT OF A BREACH OF WARRANTY, SELLER WILL, AT ITS OPTION, REPAIR OR REPLACE THE NON-CONFORMING PRODUCTS, RE-PERFORM THE SERVICES, OR REFUND THE PURCHASE PRICE PAID WITHIN A REASONABLE PERIOD OF TIME. IN NO EVENT IS SELLER LIABLE FOR ANY SPECIAL, INDIRECT, INCIDENTAL OR CONSEQUENTIAL DAMAGES INCLUDING ANY LOSS OF REVENUE OR PROFITS, WHETHER BASED IN CONTRACT, TORT OR OTHER LEGAL THEORY. IN NO EVENT SHALL SELLER'S LIABILITY UNDER ANY CLAIM MADE BY BUYER EXCEED THE PURCHASE PRICE PAID FOR THE PRODUCTS.

8. Confidential Information. Buyer acknowledges and agrees that Confidential Information has been and will be received in confidence and will remain the property of Seller. Buyer further agrees that it will not use Seller's Confidential Information for any purpose other than for the benefit of Seller and shall return all such Confidential Information to Seller within thirty (30) days upon request.

9. Loss to Buyer's Property. Buyer's Property will be considered obsolete and may be destroyed by Seller after two (2) consecutive years have elapsed without Buyer ordering the Products manufactured using Buyer's Property.

Also, Seller shall not be responsible for any loss or damage to Buyer's Property while it is in Seller's possession or control.

10. Special Tooling. Seller may impose a tooling charge for any Special Tooling. Special Tooling shall be and remain Seller's property. In no event will Buyer acquire any interest in the Special Tooling, even if such Special Tooling has been specially converted or adapted for manufacture of Goods for Buyer and notwithstanding any charges paid by Buyer. Unless otherwise agreed, Seller has the right to alter, discard or otherwise dispose of any Special Tooling or other property owned by Seller in its sole determination at any time.

11. Security Interest. To secure payment of all sums due from Buyer, Seller retains a security interest in all Products delivered to Buyer and, Buyer's acceptance of these Terms is deemed to be a Security Agreement under the Uniform Commercial Code. Buyer authorizes Seller as its attorney to execute and file on Buyer's behalf all documents Seller deems necessary to perfect Seller's security interest.

12. User Responsibility. Buyer, through its own analysis and testing, is solely responsible for making the final selection of the Products and assuring that all performance, endurance, maintenance, safety and warning requirements of the application of the Products are met. Buyer must analyze all aspects of the application and follow applicable industry standards, specifications, and any technical information provided with the Quote or the Products, such as Seller's instructions, guides and specifications. If Seller provides options of or for Products based upon data or specifications provided by Buyer, Buyer is responsible for determining that such data and specifications are suitable and sufficient for all applications and reasonably foreseeable uses of the Products. In the event Buyer is not the end-user of the Products, Buyer will ensure such end-user complies with this paragraph.

13. Use of Products, Indemnity by Buyer. Buyer shall comply with all instructions, guides and specifications provided by Seller with the Quote or the Products. If Buyer uses or resells the Products in any way prohibited by Seller's instructions, guides or specifications, or Buyer otherwise fails to comply with Seller's instructions, guides and specifications, Buyer acknowledges that any such use, resale, or non-compliance is at Buyer's sole risk. Further, Buyer shall indemnify, defend, and hold Seller harmless from any losses, claims, liabilities, damages, lawsuits, judgments and costs (including attorney fees and defense costs), whether for personal injury, property damage, intellectual property infringement or any other claim, arising out of or in connection with: (a) improper selection, design, specification, application, or any misuse of Products; (b) any act or omission, negligent or otherwise, of Buyer; (c) Seller's use of Buyer's Property; (d) damage to the Products from an external cause, repair or attempted repair by anyone other than Seller, failure to follow instructions, guides and specifications provided by Seller, use with goods not provided by Seller, or opening, modifying, deconstructing, tampering with or repackaging the Products; or (e) Buyer's failure to comply with

these Terms, including any legal or administrative proceedings, collection efforts, or other actions arising from or relating to such failure to comply. Seller shall not indemnify Buyer under any circumstance except as otherwise provided in these Terms.

14. Cancellations and Changes. Buyer may not cancel or modify, including but not limited to movement of delivery dates for the Products, any order for any reason except with Seller's written consent and upon terms that will indemnify, defend and hold Seller harmless against all direct, incidental and consequential loss or damage and any additional expense. Seller, at any time, may change features, specifications, designs and availability of Products.

15. Assignment. Buyer may not assign its rights or obligations without the prior written consent of Seller.

16. Force Majeure. Seller is not liable for delay or failure to perform any of its obligations by reason of any events or circumstances beyond its reasonable control. Such circumstances include without limitation: accidents, labor disputes or stoppages, government acts or orders, acts of nature, pandemics, epidemics, other widespread illness, or public health emergency, cyber related disruptions, cyber-attacks, ransomware sabotage, delays or failures in delivery from carriers or suppliers, shortages of materials, sudden increases in the price of raw material or components, shutdowns or slowdowns affecting the supply of raw materials or components, or the transportation thereof, oil shortages or oil price increases, energy crisis, energy or fuel interruption, war (whether declared or not) or the serious threat of same, riots, rebellions, acts of terrorism, embargoes, fire or any reason whether similar to the foregoing or otherwise. Seller will resume performance as soon as practicable after the event of force majeure has been removed. All delivery dates affected by an event of force majeure shall be tolled for the duration of such event of force majeure and rescheduled for mutually agreed dates as soon as practicable after the event of force majeure ceases to exist. The right to allocate capacity is in the Seller's sole discretion. An event of force majeure shall not include financial distress, insolvency, bankruptcy, or other similar conditions affecting one of the parties, affiliates and/or subcontractors. An event of force majeure in the meaning of these Terms means any circumstances beyond Seller's control that permanently or temporarily hinders performance, even where that circumstance was already foreseen. Buyer shall not be entitled to cancel any orders following its claim of an event of force majeure.

17. Waiver and Severability. Failure to enforce any provision of these Terms will not invalidate that provision; nor will any such failure prejudice either party's right to enforce that provision in the future. Invalidation of any provision of these Terms shall not invalidate any other provision herein and, the remaining provisions will remain in full force and effect.

18. Duration. Unless otherwise stated in the Quote, any agreement governed by or arising from these Terms shall: (a) be for an initial duration of one (1) year; and (b) shall automatically renew for successive one-year terms unless terminated by Buyer with at least 180-days written notice to Seller or if Seller terminates the agreement pursuant to Section 19 of these Terms.

19. Termination. Seller may, without liability to Buyer, terminate any agreement governed by or arising from these Terms for any reason and at any time by giving Buyer thirty (30) days prior written notice. Seller may immediately terminate, in writing, if Buyer: (a) breaches any provision of these Terms, (b) becomes or is deemed insolvent, (c) appoints or has appointed a trustee, receiver or custodian for all or any part of Buyer's property, (d) files a petition for relief in bankruptcy on its own behalf, or one is filed against Buyer by a third party, (e) makes an assignment for the benefit of creditors; or (f) dissolves its business or liquidates all or a majority of its assets.

20. Ownership of Rights. Buyer agrees that (a) Seller (and/or its affiliates) owns or is the valid licensee of Seller's IP and (b) the furnishing of information, related documents or other materials by Seller to Buyer does not grant or transfer any ownership interest or license in or to Seller's IP to Buyer, unless expressly agreed in writing. Without limiting the foregoing, Seller retains ownership of all Software supplied to Buyer. In no event shall Buyer obtain any greater right in and to the Software than a right in a license limited to the use thereof and subject to compliance

with any other terms provided with the Software. Buyer further agrees that it will not, directly or through intermediaries, reverse engineer, decompile, or disassemble any Software (including firmware) comprising or contained within a Product, except and only to the extent that such activity may be expressly permitted, either by applicable law or, in the case of open source software, the applicable open source license.

21. Indemnity for Infringement of Intellectual Property Rights. Seller is not liable for infringement of any Intellectual Property Rights except as provided in this Section. Seller will defend at its expense and will pay the cost of any settlement or damages awarded in an action brought against Buyer based on a third-party claim that one or more of the Products infringes the Intellectual Property Rights of a third party in the country of delivery of the Products by Seller to Buyer. Seller's obligation to defend and indemnify Buyer is contingent on Buyer notifying Seller within ten (10) days after Buyer becomes aware of any such claim, and Seller having sole control over the defense of the claim including all negotiations for settlement or compromise. If one or more Products is subject to such a claim, Seller may, at its sole expense and option, procure for Buyer the right to continue using the Products, replace or modify the Products to render them non-infringing, or offer to accept return of the Products and refund the purchase price less a reasonable allowance for depreciation. Seller has no obligation or liability for any claim of infringement: (i) arising from information provided by Buyer (including Seller's use of Buyer's Property); or (ii) directed to any Products for which the designs are specified in whole or part by Buyer; or (iii) resulting from the modification, combination or use in a system of any Products. The foregoing provisions of this Section constitute Seller's sole and exclusive liability and Buyer's sole and exclusive remedy for claims of infringement of Intellectual Property Rights.

22. Governing Law. These Terms, the terms of any Quote, and the sale and delivery of all Products are deemed to have taken place in, and shall be governed and construed in accordance with, the laws of the State of Ohio, as applicable to contracts executed and wholly performed therein and without regard to conflicts of laws principles. Buyer irrevocably agrees and consents to the exclusive jurisdiction and venue of the courts of Cuyahoga County, Ohio with respect to any dispute, controversy or claim arising out of or relating to the sale and delivery of the Products.

23. Entire Agreement. These Terms, along with the terms set forth in the Quote, forms the entire agreement between the Buyer and Seller and constitutes the final, complete and exclusive expression of the terms of sale and purchase. In the event of a conflict between any term set forth in the Quote and these Terms, the terms set forth in the Quote shall prevail. All prior or contemporaneous written or oral agreements or negotiations with respect to the subject matter shall have no effect. No modification to these Terms will be binding on Seller unless agreed to in a writing that is signed by an authorized representative of Seller, excluding email correspondence, 'clickwrap' or other purported electronic assent to different or additional terms. Sections 2-25 of these Terms shall survive termination or cancellation of any agreement governed by or arising from these Terms.

24. No 'Wrap' Agreements/No Authority to Bind. Seller's clicking any buttons or any similar action, such as clicking "I Agree" or "Confirm," to utilize Buyer's software or webpage for the placement of orders, is NOT an agreement to Buyer's Terms and Conditions. **NO EMPLOYEE, AGENT OR REPRESENTATIVE OF SELLER HAS THE AUTHORITY TO BIND SELLER BY THE ACT OF CLICKING ANY BUTTON OR SIMILAR ACTION ON BUYER'S WEBSITE OR PORTAL.**

25. Compliance with Laws. Buyer agrees to comply with all applicable laws, regulations, and industry and professional standards, including those of the United States of America, and the country or countries in which Buyer may operate, including without limitation the U.S. Foreign Corrupt Practices Act ("FCPA"), the U.S. Anti-Kickback Act ("Anti-Kickback Act"), U.S. and E.U. export control and sanctions laws ("Export Laws"), the U.S. Food Drug and Cosmetic Act ("FDCA"), and the rules and regulations promulgated by the U.S. Food and Drug Administration ("FDA"), each as currently amended. Buyer agrees to indemnify, defend, and hold harmless Seller from the consequences of any violation of such laws, regulations and standards by Buyer, its employees or agents. Buyer represents that it is familiar with all applicable provisions of the FCPA, the

Anti-Kickback Act, Export Laws, the FDCA and the FDA and certifies that Buyer will adhere to the requirements thereof and not take any action that would make Seller violate such requirements. Buyer represents and agrees that Buyer will not make any payment or give anything of value, directly or indirectly, to any governmental official, foreign political party or official thereof, candidate for foreign political office, or commercial entity or person, for any improper purpose, including the purpose of influencing such person to purchase Products or otherwise benefit the business of Seller. Buyer further represents and agrees that it will not receive, use, service, transfer or ship any Products from Seller in a manner or for a purpose that violates Export Laws or would cause Seller to be in violation of Export Laws. Buyer agrees to promptly and reliably provide Seller all requested information or documents, including end-user statements and other written assurances, concerning Buyer's ongoing compliance with Export Law.

Parker's Motion & Control Product Groups

At Parker, we're guided by a relentless drive to help our customers become more productive and achieve higher levels of profitability by engineering the best systems for their requirements. It means looking at customer applications from many angles to find new ways to create value. Whatever the motion and control technology need, Parker has the experience, breadth of product and global reach to consistently deliver. No company knows more about motion and control technology than Parker.

**For further info call
1 800 C-Parker
(1 800 272 7537).**



Aerospace

Key Markets

Aftermarket services
Commercial transports
Engines
General & business aviation
Helicopters
Launch vehicles
Military aircraft
Missiles
Power generation
Regional transports
Unmanned aerial vehicles

Key Products

Control systems & actuation products
Engine systems & components
Fluid conveyance systems & components
Fluid metering, delivery & atomization devices
Fuel systems & components
Fuel tank inerting systems
Hydraulic systems & components
Thermal management
Wheels & brakes



Automation

Key Markets

Alternative energy
Conveyor & material handling
Factory automation
Food & beverage
Life sciences & medical
Machine tools
Packaging machinery
Paper machinery
Plastics machinery
Primary metals
Safety & security
Semiconductor & electronics
Transportation & automotive

Key Products

AC/DC drives & systems
Air preparation
Electric actuators, gantry robots & slides
Human machine interfaces
Inverters
Manifolds
Miniature fluidics
Pneumatic actuators & grippers
Pneumatic valves & controls
Rotary actuators
Stepper motors, servo motors, drives & controls
Structural extrusions
Vacuum generators, cups & sensors



Climate & Industrial Controls

Key Markets

Agriculture
Air conditioning
Construction Machinery
Food & beverage
Industrial machinery
Life sciences
Oil & gas
Precision cooling
Process
Refrigeration
Transportation

Key Products

Accumulators
Advanced actuators
CO2 controls
Electronic controllers
Filter driers
Hand shut-off valves
Heat exchangers
Hose & fittings
Pressure regulating valves
Refrigerant distributors
Safety relief valves
Smart pumps
Solenoid valves
Thermostatic expansion valves



Filtration

Key Markets

Aerospace
Food & beverage
Industrial plant & equipment
Life sciences
Marine
Mobile equipment
Oil & gas
Power generation & renewable energy
Process
Transportation
Water Purification

Key Products

Analytical gas generators
Compressed air filters & dryers
Engine air, coolant, fuel & oil filtration systems
Fluid condition monitoring systems
Hydraulic & lubrication filters
Hydrogen, nitrogen & zero air generators
Instrumentation filters
Membrane & fiber filters
Microfiltration
Sterile air filtration
Water desalination & purification filters & systems



Fluid Connectors

Key Markets

Aerial lift
Agriculture
Bulk chemical handling
Construction machinery
Food & beverage
Fuel & gas delivery
Industrial machinery
Life sciences
Marine
Mining
Mobile
Oil & gas
Renewable energy
Transportation

Key Products

Check valves
Connectors for low pressure fluid conveyance
Deep sea umbilicals
Diagnostic equipment
Hose couplings
Industrial hose
Mooring systems & power cables
PTFE hose & tubing
Quick couplings
Rubber & thermoplastic hose
Tube fittings & adapters
Tubing & plastic fittings



Hydraulics

Key Markets

Aerial lift
Agriculture
Alternative energy
Construction machinery
Forestry
Industrial machinery
Machine tools
Marine
Material handling
Mining
Oil & gas
Power generation
Refuse vehicles
Renewable energy
Truck hydraulics
Turf equipment

Key Products

Accumulators
Cartridge valves
Electrohydraulic actuators
Human machine interfaces
Hybrid drives
Hydraulic cylinders
Hydraulic motors & pumps
Hydraulic systems
Hydraulic valves & controls
Hydrostatic steering
Integrated hydraulic circuits
Power take-offs
Power units
Rotary actuators
Sensors



Instrumentation

Key Markets

Alternative fuels
Biopharmaceuticals
Chemical & refining
Food & beverage
Marine & shipbuilding
Medical & dental
Microelectronics
Nuclear Power
Offshore oil exploration
Oil & gas
Pharmaceuticals
Power generation
Pulp & paper
Steel
Water/wastewater

Key Products

Analytical Instruments
Analytical sample conditioning products & systems
Chemical injection fittings & valves
Fluoropolymer chemical delivery fittings, valves & pumps
High purity gas delivery fittings, valves, regulators & digital flow controllers
Industrial mass flow meters/controllers
Permanent no-weld tube fittings
Precision industrial regulators & flow controllers
Process control double block & bleeds
Process control fittings, valves, regulators & manifold valves



Seal

Key Markets

Aerospace
Chemical processing
Consumer
Fluid power
General industrial
Information technology
Life sciences
Microelectronics
Military
Oil & gas
Power generation
Renewable energy
Telecommunications
Transportation

Key Products

Dynamic seals
Elastomeric o-rings
Electro-medical instrument design & assembly
EMI shielding
Extruded & precision-cut, fabricated elastomeric seals
High temperature metal seals
Homogeneous & inserted elastomeric shapes
Medical device fabrication & assembly
Metal & plastic retained composite seals
Shielded optical windows
Silicone tubing & extrusions
Thermal management
Vibration dampening



ENGINEERING YOUR SUCCESS.

Parker Fluid Connectors Group

North American Divisions & Distribution Service Centers

Your complete source for quality tube fittings, hose & hose fittings, brass & composite fittings, quick-disconnect couplings, valves and assembly tools, locally available from a worldwide network of authorized distributors.

Fittings:

Available in inch and metric sizes covering SAE, BSP, DIN, GAZ, JIS and ISO thread configurations, manufactured from steel, stainless steel, brass, aluminum, nylon and thermoplastic.

Hose, Tubing and Bundles:

Available in a wide variety of sizes and materials including rubber, wire-reinforced, thermoplastic, hybrid and custom compounds.

Worldwide Availability:

Parker operates Fluid Connectors manufacturing locations and sales offices throughout North America, South America, Europe and Asia-Pacific.

For information, call toll free...

1-800-C-PARKER
(1-800-272-7537)

North American Divisions **Fluid System Connectors** **Division**

Otsego, MI
phone 269 692 6555
fax 269 694 4614

Engineering Support:
FSC.Apps@support.parker.com

Customer Support:
FSC.Support@support.parker.com

Quote Support:
FSC.Quotes@support.parker.com

Hose Products Division

Wickliffe, OH
phone 440 943 5700
fax 440 943 3129

Parflex Division

Ravenna, OH
phone 330 296 2871
fax 330 296 8433

Quick Coupling Division

Minneapolis, MN
phone 763 544 7781
fax 763 544 3418

Tube Fittings Division

Columbus, OH
phone 614 279 7070
fax 614 279 7685

Distribution Service **Centers**

Buena Park, CA

phone 714 522 8840
fax 714 994 1183

Conyers, GA

phone 770 929 0330
fax 770 929 0230

Louisville, KY

phone 502 937 1322
fax 502 937 4180

Portland, OR

phone 503 283 1020
fax 503 283 2201

Toledo, OH

phone 419 878 7000
fax 419 878 7001
fax 419 878 7420
(FCG Kit Operations)

Canada

Milton, ONT

phone 905 693 3000
fax 905 876 1958

Mexico

Toluca, MEX

phone (52) 722 2754 200
fax (52) 722 2722 168

