

Pressure transmitter with flameproof enclosure

For applications in explosion-protected areas

Models E-10 and E-11

WIKA data sheet PE 81.27

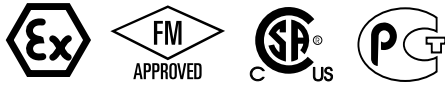

Applications

- Wellhead monitoring
- Refineries and petrochemical industry
- Drilling platforms and pipelines
- Natural gas compressors

Special features

- CSA and FM approved as “explosionproof” for class I, div. 1 hazardous areas
- ATEX approved as “flameproof enclosure” for II 2 G Ex d II C
- Current or voltage output
- Designed for harsh ambient conditions
- Low-power version available as an option



Fig. left: Model E-10, standard version (ATEX)
Fig. centre: Model E-10, standard version (FM, CSA)
Fig. right: Model E-11, with flush diaphragm (FM, CSA)

Description

The model E-10 and E-11 flameproof pressure transmitters have been designed specifically for the high demands of industrial oil and gas applications.

These pressure transmitters can be delivered with various analog signals from 4 ... 20 mA to a low-power version with DC 1 ... 5 V.

They feature an exceptionally high resistance to vibration, pressure spikes and moisture ingress. Furthermore, these pressure transmitters fulfill IP 67 (NEMA 4x) ingress protection.

On each individual instrument a comprehensive quality control and calibration is performed, so that an accuracy of $\leq 0.25\%$ BFSL can be ensured. Temperature compensation guarantees accuracy and long-term stability, even with strong fluctuations in the ambient temperature.

The models E-10 and E-11 are suitable for sour gas applications and feature particularly high resistance against sulphide stress cracking when in contact with sulphurous gases.

The pressure transmitters are approved as “explosionproof” for class I, II, III, div. 1 hazardous areas to FM and CSA as well as “flameproof” for II 2 G Ex d II C to ATEX.

Measuring ranges

Relative pressure							
bar	Measuring range	0 ... 0.4	0 ... 0.6	0 ... 1	0 ... 1.6	0 ... 2.5	0 ... 4
	Overpressure limit	3.1	3.1	3.1	6.2	6.2	14
	Measuring range	0 ... 6	0 ... 10	0 ... 16	0 ... 25	0 ... 40	0 ... 60
	Overpressure limit	31	31	62	62	80	120
	Measuring range	0 ... 100	0 ... 160	0 ... 250	0 ... 400	0 ... 600²⁾	0 ... 1,000¹⁾
	Overpressure limit	200	320	500	800	1,200	1,500
psi	Measuring range	0 ... 5	0 ... 10	0 ... 15	0 ... 25	0 ... 30	0 ... 60
	Overpressure limit	45	45	45	89	89	203
	Measuring range	0 ... 100	0 ... 160	0 ... 200	0 ... 250	0 ... 300	0 ... 500
	Overpressure limit	449	899	899	899	899	1,160
	Measuring range	0 ... 600	0 ... 750	0 ... 1,000	0 ... 1,500	0 ... 2,000	0 ... 3,000
	Overpressure limit	1,160	1,740	1,740	2,900	4,600	7,200
	Measuring range	0 ... 5,000	0 ... 8,000²⁾	0 ... 10,000¹⁾	0 ... 15,000¹⁾		
	Overpressure limit	11,600	17,400	17,400	21,750		

1) Measuring range not for Model E-11.

2) Measuring range not for Model E-11 with FM and CSA approval.

Absolute pressure						
bar	Measuring range	0 ... 0.4	0 ... 0.6	0 ... 1	0 ... 1.6	0 ... 2.5
	Overpressure limit	2	4	5	10	10
	Measuring range	0 ... 4	0 ... 6	0 ... 10	0 ... 16	
	Overpressure limit	17	35	35	80	
psi	Measuring range	0 ... 15	0 ... 25	0 ... 30	0 ... 60	0 ... 100
	Overpressure limit	72	145	145	240	500

Vacuum and +/- measuring range						
bar	Measuring range	-1 ... 0	-1 ... +0.6	-1 ... +1.5	-1 ... +3	-1 ... +5
	Overpressure limit	2	4	5	10	17
	Measuring range	-1 ... +9	-1 ... +15	-1 ... +25		
	Overpressure limit	35	35	50		
psi	Measuring range	-30 inHg ... 0	-30 inHg ... +30	-30 inHg ... +60	-30 inHg ... +100	-30 inHg ... +200
	Overpressure limit	29	145	240	500	1,160
	Measuring range	-30 inHg ... +300				
	Overpressure limit	1,160				

The given measuring ranges are also available in mbar, MPa, kPa, kg/cm² and further units.

Vacuum tightness

Yes

Output signals

Selectable output signals	
Signal type	Signal
Current output (2-wire)	4 ... 20 mA
Voltage output (3-wire)	DC 0 ... 5 V
	DC 0.5 ... 4.5 V
	DC 1 ... 5 V (low power)
	DC 0 ... 10 V

Permissible load in Ω

- 4 ... 20 mA: $\leq (\text{power supply} - 10 \text{ V}) / 0.02 \text{ A}$
- DC 0 ... 5 V: $> \text{maximum output signal} / 1 \text{ mA}$
- DC 0.5 ... 4.5 V: $> 100\text{k}$
- DC 1 ... 5 V: $> 100\text{k}$
- DC 0 ... 10 V: $> \text{maximum output signal} / 1 \text{ mA}$

Voltage supply

Power supply

The power supply depends on the selected output signal

- 4 ... 20 mA: DC 10 ... 30 V
- DC 0 ... 5 V: DC 10 ... 30 V
- DC 0.5 ... 4.5 V: DC 5 V ±10 %
- DC 1 ... 5 V: DC 6 ... 30 V
- DC 0 ... 10 V: DC 14 ... 30 V

Reference conditions (per IEC 61298-1)

Temperature

59 ... 77 °F (15 ... 25 °C)

Atmospheric pressure

12.5 ... 15.4 psi (860 ... 1,060 mbar)

Humidity

45 ... 75 % r. h.

Power supply

DC 24 V

Mounting position

Calibrated in vertical mounting position with pressure connection facing downwards.

Accuracy data

Accuracy at reference conditions

0.25 % of span (BFSL)

0.5 % of span³⁾

3) Including non-linearity, hysteresis, zero offset and end value deviation (corresponds to measured error per IEC 61298-2).

Non-linearity (per IEC 61298-2)

≤ 0.2 % of span (BFSL)

Non-repeatability

≤ 0.1 % of span

Temperature error in range 0 ... 80 °C (32 ... 176 °F)

Mean temperature coefficient of zero point:

≤ 0.2 % of span/10 K

Mean temperature coefficient of span:

≤ 0.2 % of span/10 K

Settling time

■ ≤ 2 ms

■ ≤ 10 ms (at medium temperature < -22 °F (-30 °C) and measuring range ≤ 0 ... 350 psi; for model E-11)

Long-term stability

≤ 0.2 % of span/year

Operating conditions

Ingress protection (per IEC 60529)

IP 67 (NEMA 4x)

The stated ingress protection only applies when plugged in using a mating connector that has the appropriate ingress protection.

Vibration resistance (per IEC 60068-2-6)

20 g

Shock resistance (per IEC 60068-2-27)

1,000 g (mechanical shock)

Permissible temperature ranges

■ for instruments per ATEX

Medium:	T6: -40 ... +55 °C	T6: -40 ... +131 °F
	T5: -40 ... +70 °C	T5: -40 ... +158 °F
	T4: -40 ... +100 °C	T4: -40 ... +212 °F

Ambient:	T6: -40 ... +60 °C	T6: -40 ... +140 °F
	T5: -40 ... +75 °C	T5: -40 ... +167 °F
	T4: -40 ... +105 °C	T4: -40 ... +221 °F

Storage:	-40 ... +105 °C	-40 ... +221 °F
----------	-----------------	-----------------

-40 °C (-40 °F) only valid when no sealing is used.

Sealings from NBR only admissible to -30 °C (-22 °F).

Sealings from FPM/FKM only admissible up to -15 °C (5 °F).

■ for instruments per FM, CSA

Medium:	T6: -40 ... +55 °C	T6: -40 ... +131 °F
	T4: -40 ... +100 °C	T4: -40 ... +212 °F

Ambient:	T6: -40 ... +60 °C	T6: -40 ... +140 °F
	T4: -40 ... +105 °C	T4: -40 ... +221 °F

Storage:	-40 ... +105 °C	-40 ... +221 °F
----------	-----------------	-----------------

-40 °C (-40 °F) only valid when no sealing is used.

Sealings from NBR only admissible to -30 °C (-22 °F).

Sealings from FPM/FKM only admissible to -15 °C (5 °F).

Explosion protection

ATEX

II 2 G Ex d IIC T6 ... T1

FM

XP / I / 1 ABCD / T6, T4
DIP / II, III / 1 EFG / T6, T4 type 4

CSA

Class I, Division 1, Groups A, B, C and D
Class II, Division 1, Groups E, F and G
Class III, Division 1
Type 4X

Process connections

Process connections for model E-10

Selectable process connections, model E-10	
Process connection per	Thread size
DIN 3852-E	G ¼ A
EN 837	G ¼ B G ½ B
ANSI/ASME B1.20.1	⅛ NPT ¼ NPT ½ NPT
-	¼ NPT female G ¼ A female

Process connections for model E-11

For the flush process connections there is a limited selection of measuring ranges

Selectable process connections, model E-11		
Process connection per	Thread size	Available for measuring ranges
-	G ½ B flush	0 ... 2.5 to 0 ... 400 bar
-	G 1 B flush	0 ... 0.4 to 0 ... 1.6 bar

Sealing for model E-11

Selectable sealings, model E-11	
	Material
Standard	NBR
Option	FPM/FKM
Option	EPDM

The sealing listed as "standard" is included in the delivery.

Materials

Wetted parts

- Stainless steel (additionally Elgiloy® for model E-10 with measuring range > 0 ... 40 bar, NACE-compliant)
- For sealing materials see "Process connections"

Non-wetted parts

Case from stainless steel
Cable see "Electrical connections"

Internal pressure transmission medium

Synthetic oil (no pressure transmission media for model E-10 with measuring range > 0 ... 40 bar)

For other materials see WIKA diaphragm seal programme

CE conformity

EMC directive

2004/108/EC, EN 61326 emission (group 1, class B) and interference immunity (industrial application)

Pressure equipment directive

97/23/EC

ATEX directive

94/9/EC

Approvals

- **ATEX**, flameproof (Ex d), EN 60079-0, EN 60079-1, EU
- **FM**, explosionproof class 3600, class 3615, class 3810, NEMA-250, USA
- **CSA**, class 2258 02, class 2258 82, Canada
- **GOST-R**, import certificate, Russia
- **KOSHA**, 11-AV4BO-0514, Korea

For further approvals, see website

Electrical connections

Connections

Selectable connections				
Electrical connection	Wire cross-section	Cable diameter	Cable lengths	Material
½ NPT male conduit, with potted cable outlet (ATEX approval)	3 x 0.5 mm ²	6.8 mm	2 m, 5 m	Polyolefin Copolymer
½ NPT conduit male, with cable outlet (FM and CSA approval)	3 x 0.56 mm ²	5.4 mm	up to 9 m	PVC
½ NPT male conduit with potted cable leads (FM and CSA approval)	3 x 0.5 mm ²	6.8 mm	up to 9 m	Polyolefin

Short-circuit resistance

S+ vs. U-

Reverse polarity protection

U+ vs. U-

Insulation voltage

DC 500 V

Connection diagrams

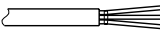
½ NPT male conduit, with potted cable outlet (ATEX approval)			
	2-wire	3-wire	
	U+	red	red
	U-	black	black
	S+	-	brown
	Shield	Shield connected to case	

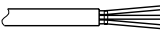
½ NPT conduit male, with cable outlet (FM and CSA approval)			
	2-wire	3-wire	
	U+	red	red
	U-	black	black
	S+	-	brown
	Shield	Shield connected to case	

½ NPT male conduit with potted cable leads (FM and CSA approval)			
	2-wire	3-wire	
	U+	red	red
	U-	black	black
	S+	-	brown
	Shield	green	green

Dimensions in mm

½ NPT male conduit, with potted cable outlet (ATEX approval)

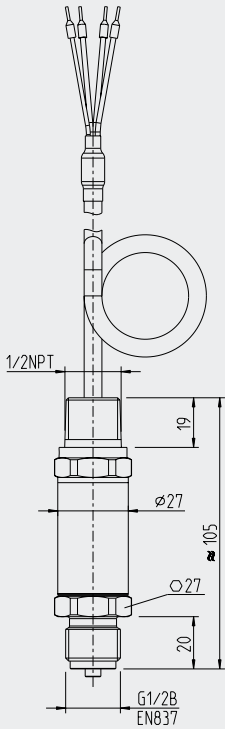

½ NPT conduit male, with cable outlet (FM and CSA approval)

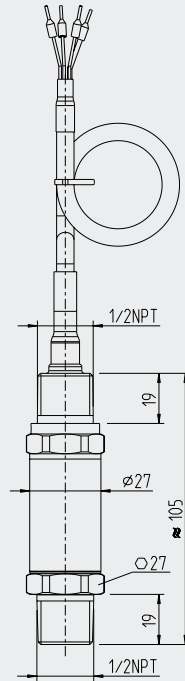

½ NPT male conduit with potted cable leads (FM and CSA approval)

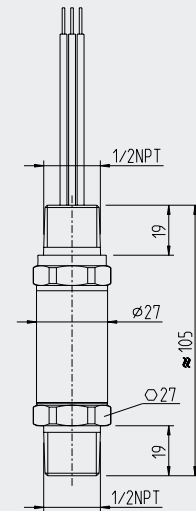

Process connections model E-10

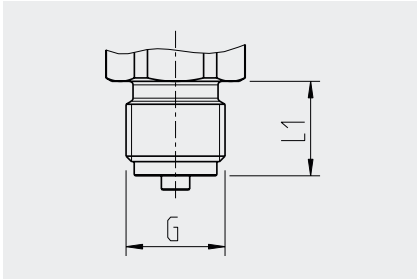

G	L1
G ¼ B	13
G ½ B	20

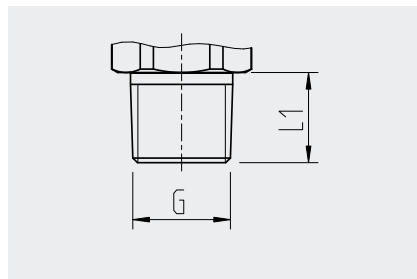

G	L1
¼ NPT	10
¼ NPT	13
½ NPT	19

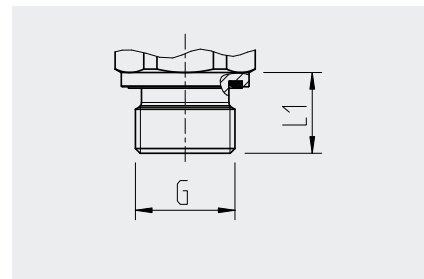

G	L1
G ¼ A	14

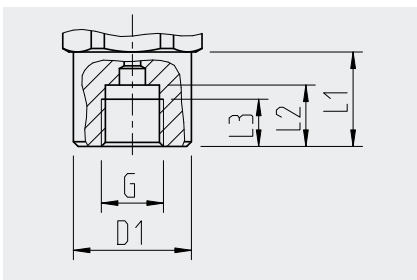

G	L1	L2	L3	D1
G ¼ female	19.5	13	10	∅17.5

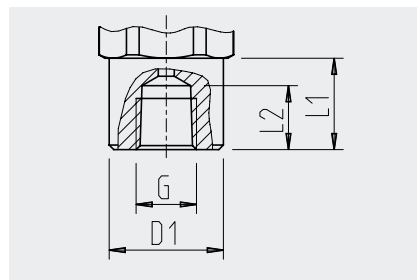

G	L1	L2	D1
¼ NPT female	20	14	∅26.5

Process connections model E-11

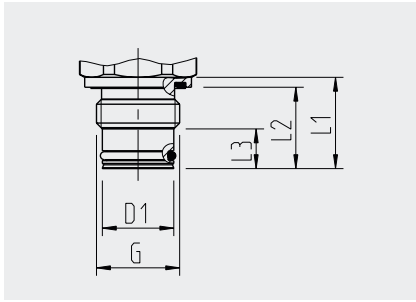

G	L1	L2	L3	D1
G ½ B	23	20.5	10	Ø 18

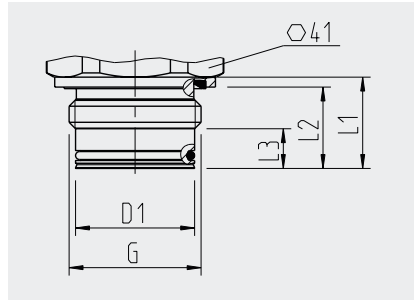

G1	L1	L2	L3	D1
G 1 B	23	20.5	10	30

For information on tapped holes and welding sockets, see Technical information IN 00.14 at www.wika.com

Ordering information

Model / Measuring range / Output signal / Electrical connection / Process connection / Sealing

© 2016 WIKA Alexander Wiegand SE & Co. KG, all rights reserved.
 The specifications given in this document represent the state of engineering at the time of publishing.
 We reserve the right to make modifications to the specifications and materials.



WIKAL Instrument, LP
 1000 Wiegand Blvd.
 Lawrenceville, GA 30043
 Tel: 888-WIKA-USA • 770-513-8200
 Fax: 770-338-5118
info@wika.com
www.wika.com