



AUTOMATION

+

ROBOTICS

+

MACHINE VISION

+

MOTION CONTROL

+

RELATED TECHNOLOGIES

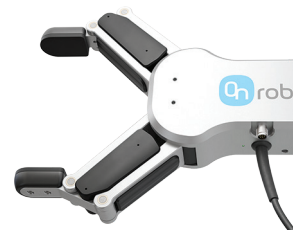
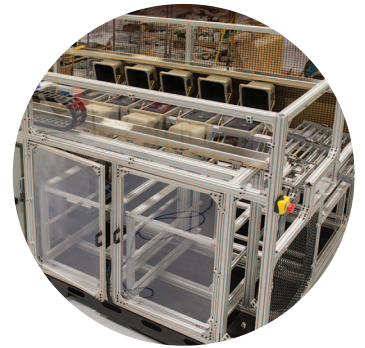

who

RG GROUP provides leadership in the design and delivery of innovative industrial automation. For over 60 years, we've collaborated with customers, creating a sustainable competitive advantage by demonstrating trusted expertise in the design, application and supply of high-quality automated systems, robots and parts to companies big and small. Our goal is to see our customers thrive by offering cost-effective automation solutions.

Trusted
Expertise



what

WE HELP COMPANIES AUTOMATE

Customer demands, and the technologies used to meet them, constantly evolve. To keep up, automation makes things faster, smarter, more accurate and more cost-effective — giving you a competitive advantage. **Operate at your best!**

FORWARD THINKING

Our ability to create **First-of-a-Kind** turnkey solutions is combined with a variety of real-time made-to-order solutions. We stay ahead of the technological curve, bringing you tomorrow's solutions TODAY.

IN-HOUSE ENGINEERING

Our in-house engineers provide creative solutions from the beginning of your project to the end. With our technical expertise, we can create the parts you need, instead of relying solely on pre-made parts.

INSTALLATION AND TRAINING

Our team provides expert engineering assistance, installation, product training and post-sale technical support.

PROJECT SUPPORT

From concept to deployment, we're here to support your project.



why

INDUSTRIAL AUTOMATION

In manufacturing, so many tasks involve moving parts... moving parts from one part of the process to another. Moving components to the line, moving finished pieces to shipping, loading and unloading, the possibilities for robotic automation are **endless**.

Cost-effective and flexible solutions will:

- Reduce your manufacturing costs
- Speed up your processes
- Increase your productivity
- Eliminate lost time accident expenses
- Ensure consistent quality control standards
- Allow processes to run without interruption
- Offer gentle handling of payload
- Minimize waste, maximize efficiency

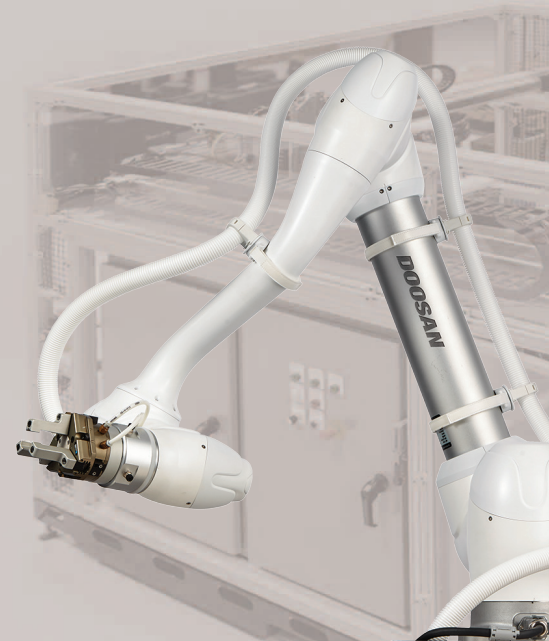

how

INDUSTRY-LEADING TECHNOLOGIES

We work with some of the finest industrial automation manufacturers in the world, supplying components for machine and process control, automated inspection, remote monitoring, connectivity, motion control, and robotics.

RG Group is your premier source for collaborative and robust industrial robots to meet all your manufacturing automation needs.

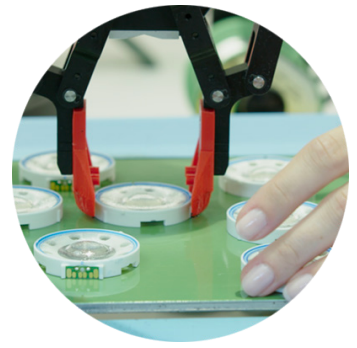
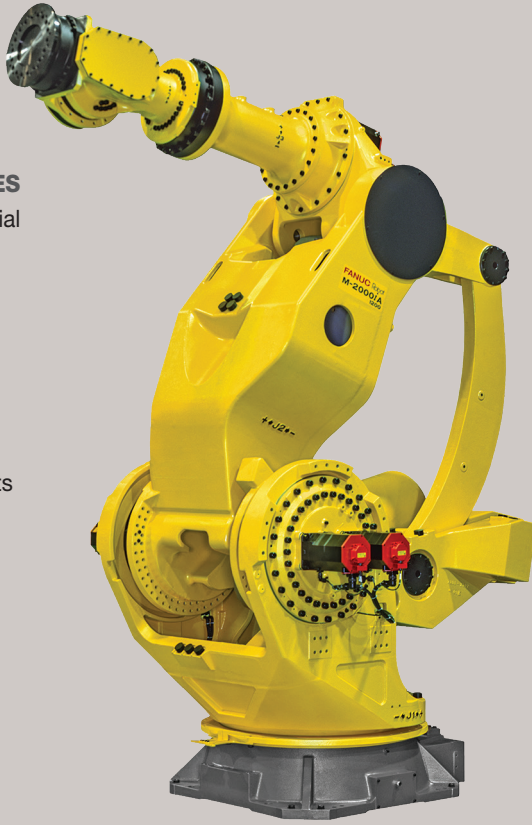

Our Expertise

- Motion / Process Control Solutions
- Robotics
- Machine Vision
- Industrial Computers and Hardware
- Visual Factory Systems
- HMI / SCADA and Plant Reporting
- Connectivity Solutions

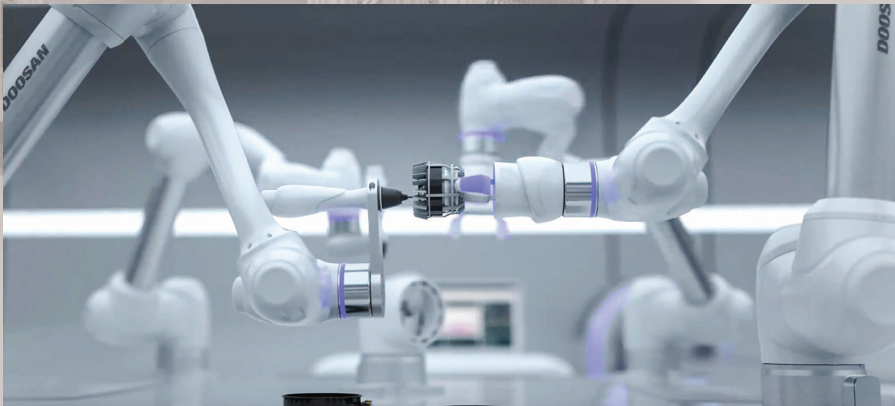
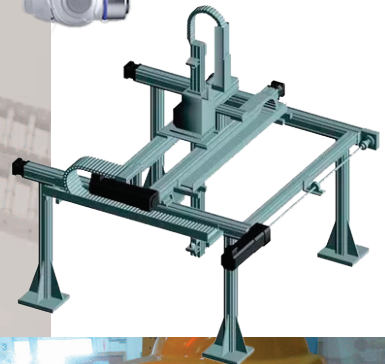

Our partnerships allows us direct access to manufacturer resources to provide our customers complete and knowledgeable expertise.

We proudly feature:

Asyrii* Flexible feeding systems

Balluff Object detection, linear measurement, fluid sensors, RFID and industrial networking

Canon* 3D vision systems for bin picking

Cognex* Industrial machine vision and barcode readers

Destaco Automation, workholding and containment products

Doosan Robotics Industrial collaborative robots

Dynics* Industrial computers and hardware

FANUC Robotics, CNC systems and factory automation

Exor* End to end connectivity and IIoT

Graco* Flexible feeding systems

iKey* Industrial peripherals

MB Connect Line* Remote maintenance solutions

MiR Mobile industrial robots

Mitsubishi* PLCs, VFDs, motion control and robotics

Moxa Industrial networking, computing, and automation solutions

OnRobot Plug + Play end-of-arm tooling

Parker Automation Drives, controllers, motors, gearheads, actuators and electrical cylinders

Robotiq Plug + Play components for collaborative robots

Tatsoft* Real-time automation and SCADA / IIoT software

Unitronics* Compact, powerful PLC / HMI systems



Corporate

650 North State Street, York, PA 17403

Robotics Lab

15 Flour Mill Road West, York, PA 17406

325 S Main St, Pittsburgh, PA 15220